

Inductors for standard circuits
Multilayer ferrite
MLF series (for automotive)



AEC-Q200

MLF2012 type



FEATURES

- The lineup includes a wide inductance range.
- Highly reliable monolithic structure with multilayer integration.
- Operating temperature range: -55 to +125°C

APPLICATION

- Automotive equipment, smart phones, tablet terminals, tuners, LCD-TVs, PDP-TVs, audio equipment, computers, signal processing for modules etc.

PART NUMBER CONSTRUCTION

| | | | | | | |
|-------------|--|-----------------|--------------------------|-------------------------|-----------------|---------------|
| MLF | 2012 | D | 47N | △ | T | D25 |
| Series name | LxWxH dimensions 2.0x1.25x0.85 mm 2.0x1.25x1.25 mm | Characteristics | Inductance (μ H) | Inductance tolerance | Packaging style | Internal code |

* The " \triangle " of the Part Number contains the inductance tolerance code, J ($\pm 5\%$), K ($\pm 10\%$), or M ($\pm 20\%$).

CHARACTERISTICS SPECIFICATION TABLE

| L (μ H) | Q Tolerance | Q | | L, Q measuring conditions | | Self-resonant frequency | | DC resistance | | Rated current (mA)max. | Thickness (mm) | Part No.* |
|-----------------|----------------|------|------|---------------------------|-----------------|-------------------------|-----------|------------------|------------------|---------------------------|-------------------|----------------------------------|
| | | min. | typ. | Frequency (MHz) | Current (mA) | (MHz)min. | (MHz)typ. | (Ω)max. | (Ω)typ. | | | |
| 0.047 | $\pm 20\%$ | 15 | 25 | 50 | 1.0 | 550 | 700 | 0.10 | 0.05 | 300 | 0.85 | MLF2012D47NMTD25 |
| 0.068 | $\pm 20\%$ | 15 | 25 | 50 | 1.0 | 500 | 600 | 0.15 | 0.08 | 300 | 0.85 | MLF2012D68NMTD25 |
| 0.082 | $\pm 20\%$ | 15 | 25 | 50 | 1.0 | 450 | 550 | 0.15 | 0.08 | 300 | 0.85 | MLF2012D82NMTD25 |
| 0.10 | $\pm 5\%$ | 20 | 30 | 25 | 1.0 | 400 | 500 | 0.15 | 0.10 | 300 | 0.85 | MLF2012DR10JTD25 |
| | $\pm 10\%$ | | | | | | | | | | | MLF2012DR10KTD25 |
| | $\pm 20\%$ | | | | | | | | | | | MLF2012DR10MTD25 |
| 0.12 | $\pm 5\%$ | 20 | 30 | 25 | 1.0 | 360 | 450 | 0.20 | 0.12 | 300 | 0.85 | MLF2012DR12JTD25 |
| | $\pm 10\%$ | | | | | | | | | | | MLF2012DR12KTD25 |
| | $\pm 20\%$ | | | | | | | | | | | MLF2012DR12MTD25 |
| 0.15 | $\pm 5\%$ | 20 | 30 | 25 | 1.0 | 320 | 410 | 0.20 | 0.13 | 300 | 0.85 | MLF2012DR15JTD25 |
| | $\pm 10\%$ | | | | | | | | | | | MLF2012DR15KTD25 |
| | $\pm 20\%$ | | | | | | | | | | | MLF2012DR15MTD25 |
| 0.18 | $\pm 5\%$ | 20 | 30 | 25 | 1.0 | 280 | 370 | 0.25 | 0.15 | 300 | 0.85 | MLF2012DR18JTD25 |
| | $\pm 10\%$ | | | | | | | | | | | MLF2012DR18KTD25 |
| | $\pm 20\%$ | | | | | | | | | | | MLF2012DR18MTD25 |
| 0.22 | $\pm 5\%$ | 20 | 30 | 25 | 1.0 | 250 | 330 | 0.30 | 0.16 | 250 | 0.85 | MLF2012DR22JTD25 |
| | $\pm 10\%$ | | | | | | | | | | | MLF2012DR22KTD25 |
| | $\pm 20\%$ | | | | | | | | | | | MLF2012DR22MTD25 |
| 0.27 | $\pm 5\%$ | 20 | 30 | 25 | 1.0 | 220 | 300 | 0.35 | 0.18 | 250 | 0.85 | MLF2012DR27JTD25 |
| | $\pm 10\%$ | | | | | | | | | | | MLF2012DR27KTD25 |
| | $\pm 20\%$ | | | | | | | | | | | MLF2012DR27MTD25 |

Measurement equipment

| Measurement item | Product No. | Manufacturer |
|-------------------------|--------------|-----------------------|
| L, Q | 4294A+16034G | Keysight Technologies |
| Self-resonant frequency | E4991A | Keysight Technologies |
| DC resistance | Type-7561 | Yokogawa |

* Equivalent measurement equipment may be used.

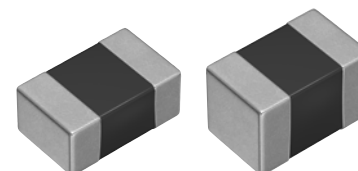

⚠ Please be sure to request delivery specifications that provide further details on the features and specifications of the products for proper and safe use.
Please note that the contents may change without any prior notice due to reasons such as upgrading.

(1/9)

20190205

inductor_automotive_standard_mlf2012_en

MLF2012 type

CHARACTERISTICS SPECIFICATION TABLE

| L | Q | L, Q measuring conditions | | | Self-resonant frequency | | DC resistance | | Rated current | | Thickness | Part No.* |
|------------|------------|---------------------------|------|-----------------|-------------------------|-----------|---------------|------------------|------------------|----------|-----------|----------------------------------|
| | | min. | typ. | Frequency (MHz) | Current (mA) | (MHz)min. | (MHz)typ. | (Ω)max. | (Ω)typ. | (mA)max. | | |
| (μ H) | Tolerance | | | | | | | | | | (mm) | |
| 0.33 | $\pm 5\%$ | 20 | 30 | 25 | 1.0 | 200 | 270 | 0.40 | 0.23 | 250 | 0.85 | MLF2012DR33JTD25 |
| | $\pm 10\%$ | | | | | | | | | | | MLF2012DR33KTD25 |
| | $\pm 20\%$ | | | | | | | | | | | MLF2012DR33MTD25 |
| 0.39 | $\pm 5\%$ | 25 | 35 | 25 | 1.0 | 180 | 250 | 0.45 | 0.25 | 200 | 0.85 | MLF2012DR39JTD25 |
| | $\pm 10\%$ | | | | | | | | | | | MLF2012DR39KTD25 |
| | $\pm 20\%$ | | | | | | | | | | | MLF2012DR39MTD25 |
| 0.47 | $\pm 5\%$ | 25 | 35 | 25 | 1.0 | 160 | 230 | 0.50 | 0.25 | 200 | 1.25 | MLF2012DR47JTD25 |
| | $\pm 10\%$ | | | | | | | | | | | MLF2012DR47KTD25 |
| | $\pm 20\%$ | | | | | | | | | | | MLF2012DR47MTD25 |
| 0.56 | $\pm 5\%$ | 25 | 35 | 25 | 1.0 | 150 | 210 | 0.55 | 0.30 | 150 | 1.25 | MLF2012DR56JTD25 |
| | $\pm 10\%$ | | | | | | | | | | | MLF2012DR56KTD25 |
| | $\pm 20\%$ | | | | | | | | | | | MLF2012DR56MTD25 |
| 0.68 | $\pm 5\%$ | 25 | 35 | 25 | 1.0 | 140 | 190 | 0.60 | 0.35 | 150 | 1.25 | MLF2012DR68JTD25 |
| | $\pm 10\%$ | | | | | | | | | | | MLF2012DR68KTD25 |
| | $\pm 20\%$ | | | | | | | | | | | MLF2012DR68MTD25 |
| 0.82 | $\pm 5\%$ | 25 | 35 | 25 | 1.0 | 130 | 170 | 0.65 | 0.40 | 150 | 1.25 | MLF2012DR82JTD25 |
| | $\pm 10\%$ | | | | | | | | | | | MLF2012DR82KTD25 |
| | $\pm 20\%$ | | | | | | | | | | | MLF2012DR82MTD25 |
| 1.0 | $\pm 5\%$ | 45 | 55 | 10 | 1.0 | 120 | 160 | 0.30 | 0.15 | 80 | 0.85 | MLF2012A1R0JTD25 |
| | $\pm 10\%$ | | | | | | | | | | | MLF2012A1R0KTD25 |
| | $\pm 20\%$ | | | | | | | | | | | MLF2012A1R0MTD25 |
| 1.2 | $\pm 5\%$ | 45 | 55 | 10 | 1.0 | 110 | 150 | 0.35 | 0.15 | 80 | 0.85 | MLF2012A1R2JTD25 |
| | $\pm 10\%$ | | | | | | | | | | | MLF2012A1R2KTD25 |
| | $\pm 20\%$ | | | | | | | | | | | MLF2012A1R2MTD25 |
| 1.5 | $\pm 5\%$ | 45 | 60 | 10 | 1.0 | 100 | 140 | 0.40 | 0.18 | 80 | 0.85 | MLF2012A1R5JTD25 |
| | $\pm 10\%$ | | | | | | | | | | | MLF2012A1R5KTD25 |
| | $\pm 20\%$ | | | | | | | | | | | MLF2012A1R5MTD25 |
| 1.8 | $\pm 5\%$ | 45 | 60 | 10 | 1.0 | 90 | 130 | 0.45 | 0.20 | 80 | 0.85 | MLF2012A1R8JTD25 |
| | $\pm 10\%$ | | | | | | | | | | | MLF2012A1R8KTD25 |
| | $\pm 20\%$ | | | | | | | | | | | MLF2012A1R8MTD25 |
| 2.2 | $\pm 5\%$ | 45 | 60 | 10 | 1.0 | 80 | 120 | 0.50 | 0.22 | 50 | 0.85 | MLF2012A2R2JTD25 |
| | $\pm 10\%$ | | | | | | | | | | | MLF2012A2R2KTD25 |
| | $\pm 20\%$ | | | | | | | | | | | MLF2012A2R2MTD25 |
| 2.7 | $\pm 5\%$ | 45 | 70 | 10 | 1.0 | 70 | 100 | 0.55 | 0.25 | 50 | 1.25 | MLF2012A2R7JTD25 |
| | $\pm 10\%$ | | | | | | | | | | | MLF2012A2R7KTD25 |
| | $\pm 20\%$ | | | | | | | | | | | MLF2012A2R7MTD25 |
| 3.3 | $\pm 5\%$ | 45 | 70 | 10 | 1.0 | 60 | 90 | 0.60 | 0.28 | 50 | 1.25 | MLF2012A3R3JTD25 |
| | $\pm 10\%$ | | | | | | | | | | | MLF2012A3R3KTD25 |
| | $\pm 20\%$ | | | | | | | | | | | MLF2012A3R3MTD25 |
| 3.9 | $\pm 5\%$ | 45 | 70 | 10 | 1.0 | 55 | 80 | 0.65 | 0.30 | 30 | 1.25 | MLF2012A3R9JTD25 |
| | $\pm 10\%$ | | | | | | | | | | | MLF2012A3R9KTD25 |
| | $\pm 20\%$ | | | | | | | | | | | MLF2012A3R9MTD25 |
| 4.7 | $\pm 5\%$ | 45 | 70 | 10 | 1.0 | 50 | 70 | 0.70 | 0.35 | 30 | 1.25 | MLF2012A4R7JTD25 |
| | $\pm 10\%$ | | | | | | | | | | | MLF2012A4R7KTD25 |
| | $\pm 20\%$ | | | | | | | | | | | MLF2012A4R7MTD25 |
| 5.6 | $\pm 5\%$ | 50 | 75 | 4 | 0.1 | 45 | 65 | 0.60 | 0.30 | 15 | 1.25 | MLF2012E5R6JTD25 |
| | $\pm 10\%$ | | | | | | | | | | | MLF2012E5R6KTD25 |
| | $\pm 20\%$ | | | | | | | | | | | MLF2012E5R6MTD25 |
| 6.8 | $\pm 5\%$ | 50 | 75 | 4 | 0.1 | 40 | 60 | 0.65 | 0.32 | 15 | 1.25 | MLF2012E6R8JTD25 |
| | $\pm 10\%$ | | | | | | | | | | | MLF2012E6R8KTD25 |
| | $\pm 20\%$ | | | | | | | | | | | MLF2012E6R8MTD25 |
| 8.2 | $\pm 5\%$ | 50 | 75 | 4 | 0.1 | 35 | 55 | 0.70 | 0.35 | 15 | 1.25 | MLF2012E8R2JTD25 |
| | $\pm 10\%$ | | | | | | | | | | | MLF2012E8R2KTD25 |
| | $\pm 20\%$ | | | | | | | | | | | MLF2012E8R2MTD25 |

Measurement equipment

| Measurement item | Product No. | Manufacturer |
|-------------------------|--------------|-----------------------|
| L, Q | 4294A+16034G | Keysight Technologies |
| Self-resonant frequency | E4991A | Keysight Technologies |
| DC resistance | Type-7561 | Yokogawa |

* Equivalent measurement equipment may be used.

 Please be sure to request delivery specifications that provide further details on the features and specifications of the products for proper and safe use. (2/9)
Please note that the contents may change without any prior notice due to reasons such as upgrading.

20190205

inductor_automotive_standard_mlf2012_en

MLF2012 type

CHARACTERISTICS SPECIFICATION TABLE

| L | Q | L, Q measuring conditions | | Self-resonant frequency | | DC resistance | | Rated current | | Thickness | Part No.* | |
|-----|---------------------------------------|---------------------------|---------|-------------------------|-----------|------------------|------------------|---------------|------|-----------|-----------|--|
| | | Frequency | Current | (MHz)min. | (MHz)typ. | (Ω)max. | (Ω)typ. | (mA)max. | (mm) | | | |
| 10 | $\pm 5\%$ $\pm 10\%$ $\pm 20\%$ | 50 | 75 | 2 | 0.1 | 30 | 50 | 0.80 | 0.40 | 15 | 1.25 | MLF2012E100JTD25 MLF2012E100KTD25 MLF2012E100MTD25 |
| 12 | $\pm 5\%$ $\pm 10\%$ $\pm 20\%$ | 50 | 75 | 2 | 0.1 | 25 | 45 | 0.90 | 0.50 | 15 | 1.25 | MLF2012E120JTD25 MLF2012E120KTD25 MLF2012E120MTD25 |
| 15 | $\pm 10\%$ $\pm 20\%$ | 30 | 45 | 1 | 0.1 | 22 | 40 | 0.70 | 0.35 | 5 | 1.25 | MLF2012C150KTD25 MLF2012C150MTD25 |
| 18 | $\pm 10\%$ $\pm 20\%$ | 30 | 45 | 1 | 0.1 | 20 | 38 | 0.80 | 0.38 | 5 | 1.25 | MLF2012C180KTD25 MLF2012C180MTD25 |
| 22 | $\pm 10\%$ $\pm 20\%$ | 30 | 45 | 1 | 0.1 | 18 | 35 | 0.90 | 0.45 | 5 | 1.25 | MLF2012C220KTD25 MLF2012C220MTD25 |
| 27 | $\pm 10\%$ $\pm 20\%$ | 30 | 45 | 1 | 0.1 | 17 | 33 | 1.00 | 0.50 | 5 | 1.25 | MLF2012C270KTD25 MLF2012C270MTD25 |
| 33 | $\pm 10\%$ $\pm 20\%$ | 30 | 45 | 0.4 | 0.1 | 15 | 28 | 1.10 | 0.55 | 5 | 1.25 | MLF2012C330KTD25 MLF2012C330MTD25 |
| 39 | $\pm 10\%$ $\pm 20\%$ | 35 | 55 | 2 | 0.1 | 13 | 23 | 2.40 | 1.30 | 4 | 1.25 | MLF2012K390KTD25 MLF2012K390MTD25 |
| 47 | $\pm 10\%$ $\pm 20\%$ | 35 | 55 | 2 | 0.1 | 11 | 20 | 2.70 | 1.60 | 4 | 1.25 | MLF2012K470KTD25 MLF2012K470MTD25 |
| 56 | $\pm 10\%$ $\pm 20\%$ | 35 | 55 | 2 | 0.1 | 10 | 18 | 2.80 | 1.80 | 4 | 1.25 | MLF2012K560KTD25 MLF2012K560MTD25 |
| 68 | $\pm 10\%$ $\pm 20\%$ | 25 | 45 | 1 | 0.1 | 9 | 16 | 2.90 | 2.00 | 2 | 1.25 | MLF2012C680KTD25 MLF2012C680MTD25 |
| 82 | $\pm 10\%$ $\pm 20\%$ | 25 | 45 | 1 | 0.1 | 8 | 14 | 3.00 | 2.40 | 2 | 1.25 | MLF2012C820KTD25 MLF2012C820MTD25 |
| 100 | $\pm 10\%$ $\pm 20\%$ | 25 | 45 | 1 | 0.1 | 7 | 12 | 3.10 | 2.50 | 2 | 1.25 | MLF2012C101KTD25 MLF2012C101MTD25 |

Measurement equipment

| Measurement item | Product No. | Manufacturer |
|-------------------------|--------------|-----------------------|
| L, Q | 4294A+16034G | Keysight Technologies |
| Self-resonant frequency | E4991A | Keysight Technologies |
| DC resistance | Type-7561 | Yokogawa |

* Equivalent measurement equipment may be used.

MLF2012 type

L FREQUENCY CHARACTERISTICS

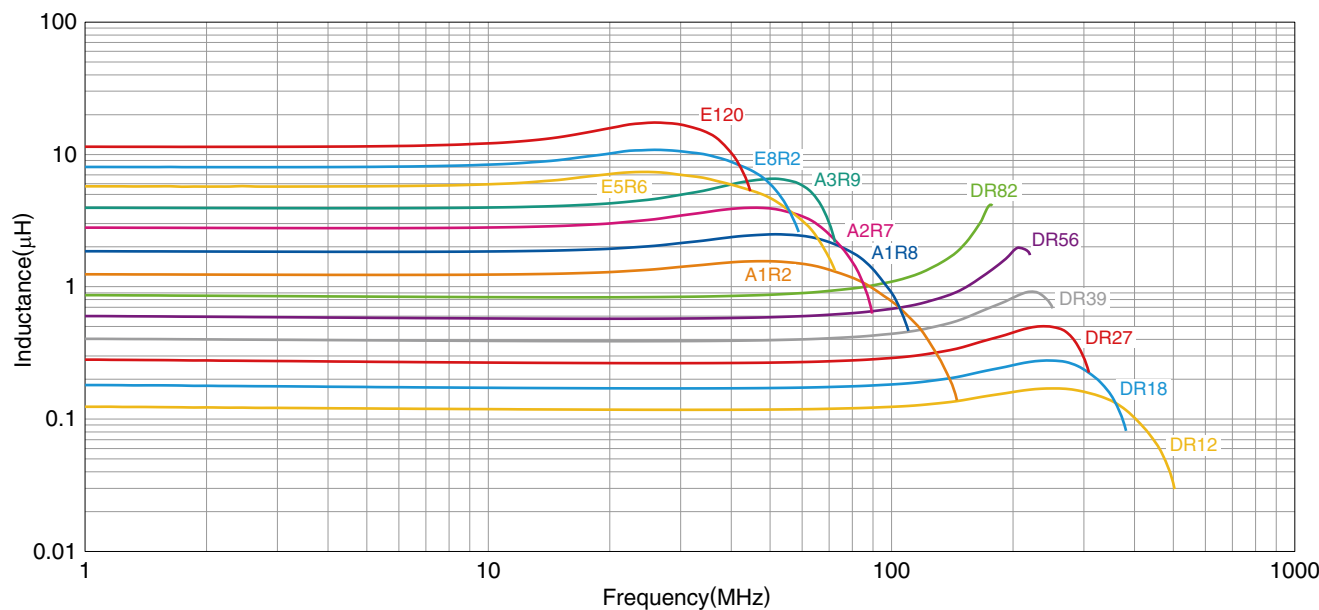
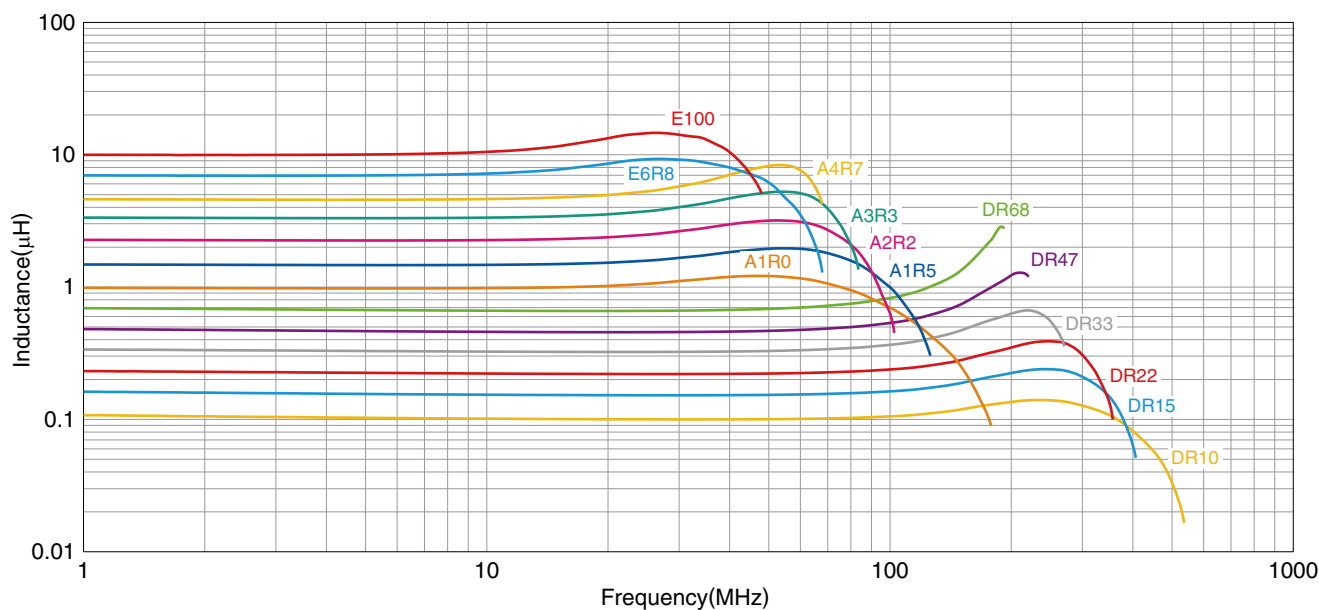

Measurement equipment

| Product No. | Manufacturer |
|---------------|-----------------------|
| E4991A+16192A | Keysight Technologies |

* Equivalent measurement equipment may be used.

MLF2012 type

L FREQUENCY CHARACTERISTICS

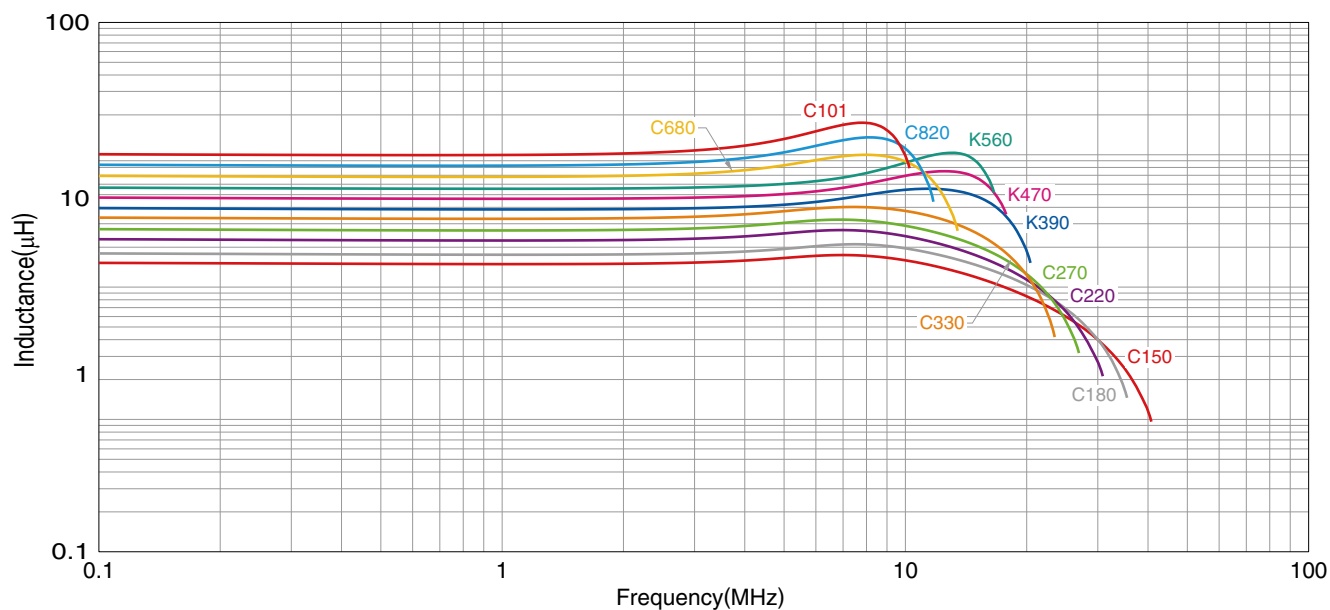

Measurement equipment

| Product No. | Manufacturer |
|--------------|-----------------------|
| 4294A+16034G | Keysight Technologies |

* Equivalent measurement equipment may be used.

MLF2012 type

Q FREQUENCY CHARACTERISTICS

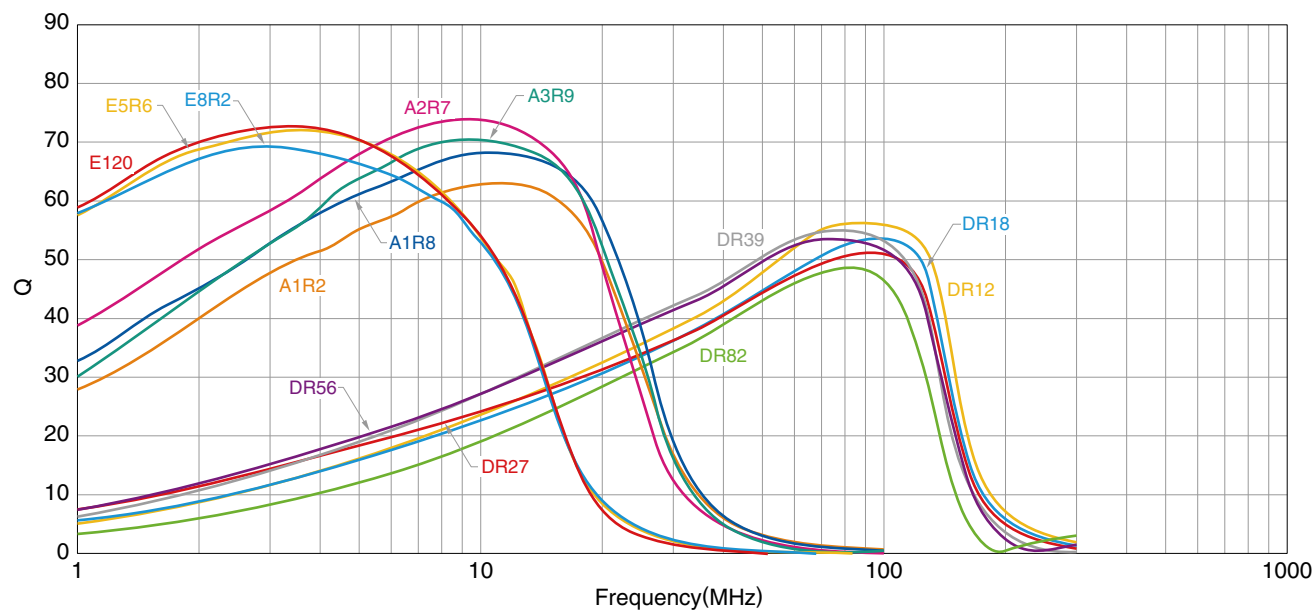
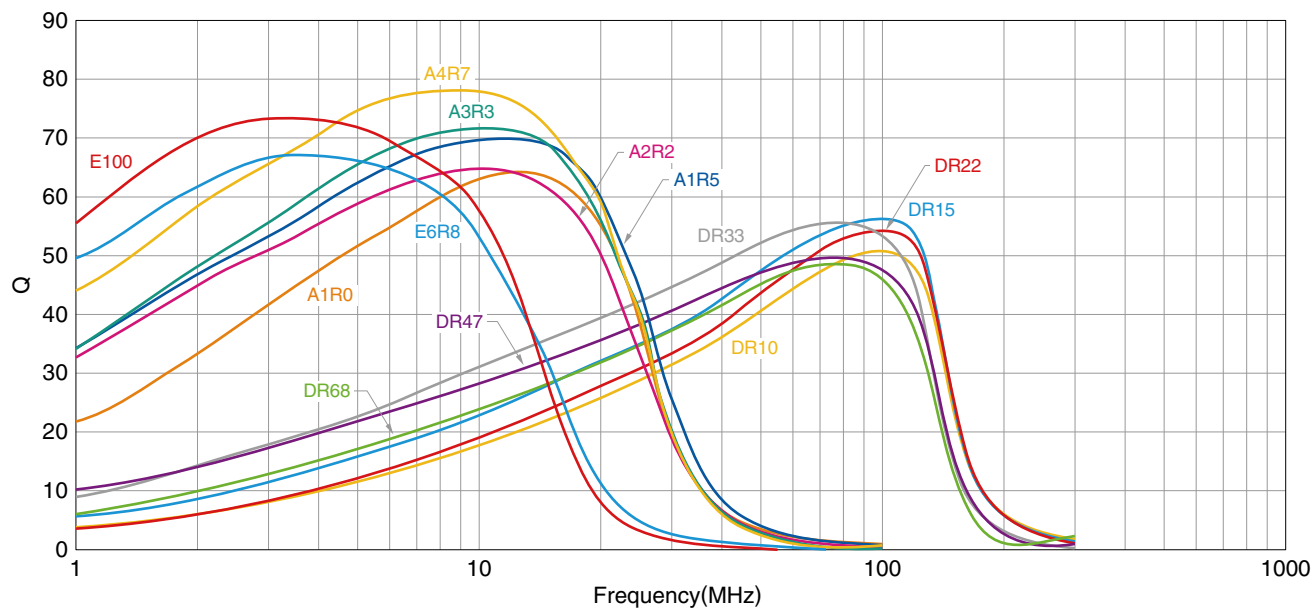

Measurement equipment

| Product No. | Manufacturer |
|---------------|-----------------------|
| E4991A+16192A | Keysight Technologies |

* Equivalent measurement equipment may be used.

MLF2012 type

Q FREQUENCY CHARACTERISTICS

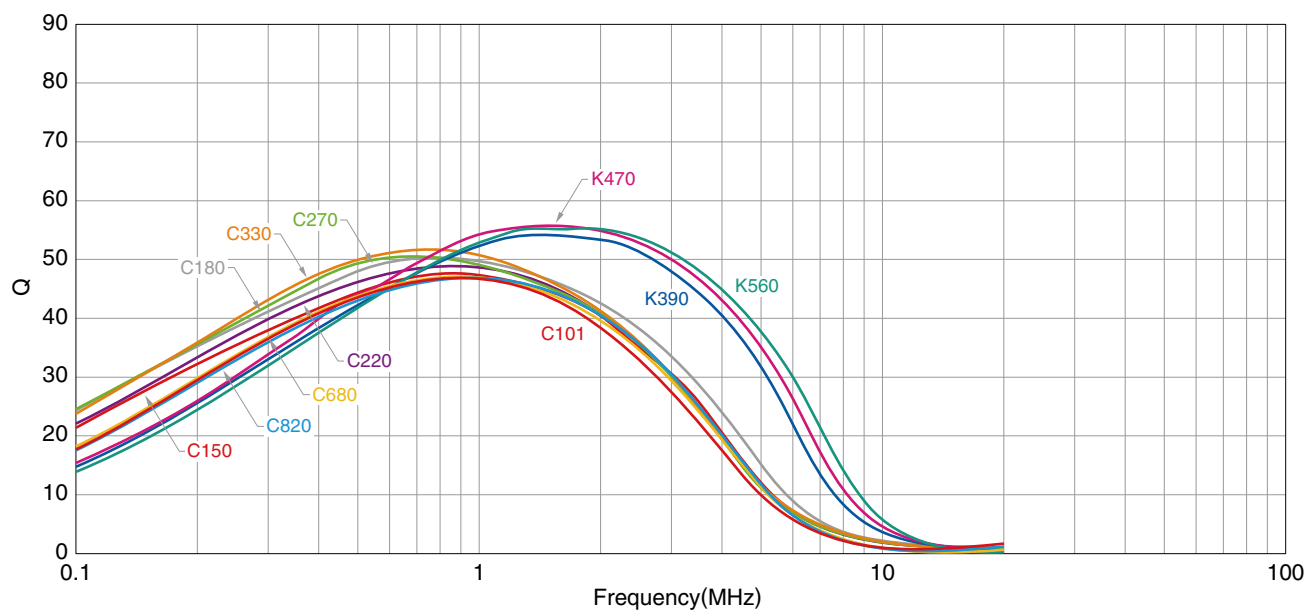

Measurement equipment

| Product No. | Manufacturer |
|--------------|-----------------------|
| 4294A+16034G | Keysight Technologies |

* Equivalent measurement equipment may be used.

MLF2012 type

SHAPE & DIMENSIONS

t=0.85mm

t=1.25mm

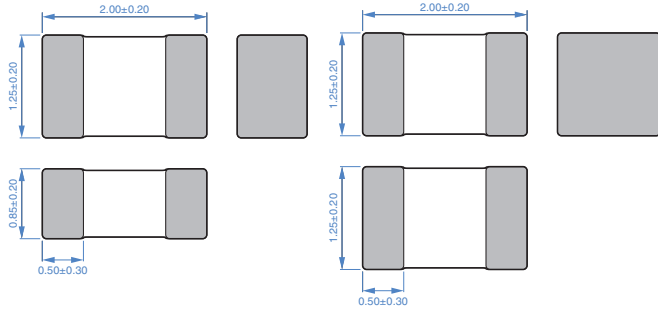

Dimensions in mm

PACKAGING STYLE

REEL DIMENSIONS

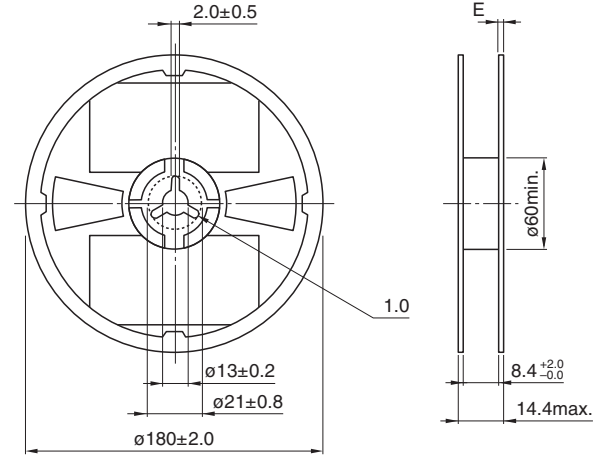

Dimensions in mm

RECOMMENDED LAND PATTERN

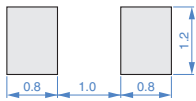

Dimensions in mm

TAPE DIMENSIONS

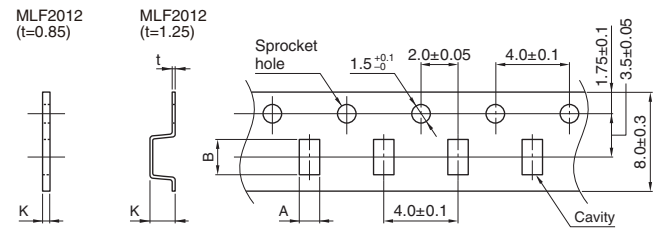

Dimensions in mm

| Type | | A | B | K |
|---------|--------|---------|---------|----------|
| MLF2012 | t=0.85 | 1.5±0.2 | 2.3±0.2 | 1.1 max. |
| | t=1.25 | 1.5±0.2 | 2.3±0.2 | 1.5 max. |

RECOMMENDED REFLOW PROFILE

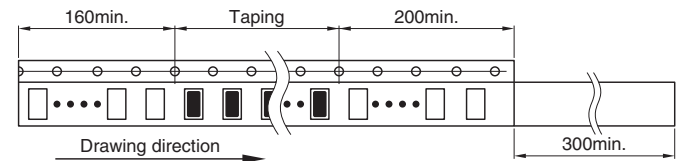
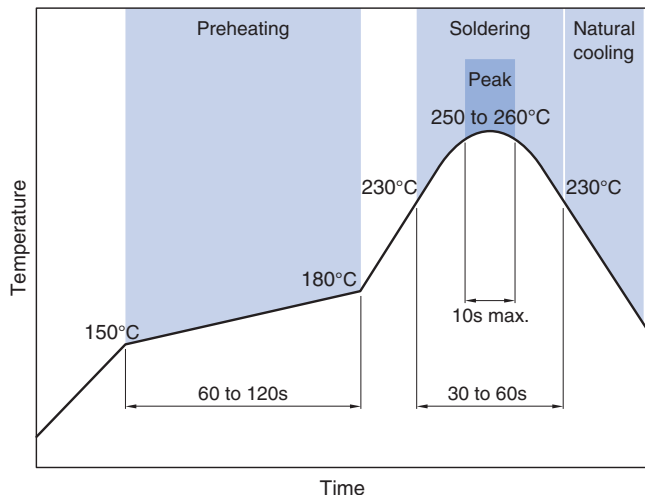

Dimensions in mm

PACKAGE QUANTITY

| Package quantity | t=0.85mm | t=1.25mm |
|------------------|---------------|---------------|
| | 4000 pcs/reel | 2000 pcs/reel |

TEMPERATURE RANGE, INDIVIDUAL WEIGHT

| Type | Operating temperature range* | Storage temperature range** | Individual weight |
|----------|------------------------------|-----------------------------|-------------------|
| t=0.85mm | -55 to +125 °C | -55 to +125 °C | 10 mg |
| t=1.25mm | -55 to +125 °C | -55 to +125 °C | 14 mg |

* In case the product's inductance is 15µH or higher, both operating and storage temperature ranges are -40 to +85°C.

** The storage temperature range is for after the assembly.

REMINDERS FOR USING THESE PRODUCTS

Before using these products, be sure to request the delivery specifications.

SAFETY REMINDERS

Please pay sufficient attention to the warnings for safe designing when using this products.

REMINDERS

- The storage period is less than 12 months. Be sure to follow the storage conditions (temperature: 5 to 40°C, humidity: 10 to 75% RH or less).
If the storage period elapses, the soldering of the terminal electrodes may deteriorate.
- Do not use or store in locations where there are conditions such as gas corrosion (salt, acid, alkali, etc.).
- Before soldering, be sure to preheat components.
The preheating temperature should be set so that the temperature difference between the solder temperature and chip temperature does not exceed 150°C.
- Soldering corrections after mounting should be within the range of the conditions determined in the specifications.
If overheated, a short circuit, performance deterioration, or lifespan shortening may occur.
- When embedding a printed circuit board where a chip is mounted to a set, be sure that residual stress is not given to the chip due to the overall distortion of the printed circuit board and partial distortion such as at screw tightening portions.
- Self heating (temperature increase) occurs when the power is turned ON, so the tolerance should be sufficient for the set thermal design.
- Carefully lay out the coil for the circuit board design of the non-magnetic shield type.
A malfunction may occur due to magnetic interference.
- Use a wrist band to discharge static electricity in your body through the grounding wire.
- Do not expose the products to magnets or magnetic fields.
- Do not use for a purpose outside of the contents regulated in the delivery specifications.
- The products listed on this catalog are intended for use in general electronic equipment (AV equipment, telecommunications equipment, home appliances, amusement equipment, computer equipment, personal equipment, office equipment, measurement equipment, industrial robots) under a normal operation and use condition.
The products are not designed or warranted to meet the requirements of the applications listed below, whose performance and/or quality require a more stringent level of safety or reliability, or whose failure, malfunction or trouble could cause serious damage to society, person or property.
If you intend to use the products in the applications listed below or if you have special requirements exceeding the range or conditions set forth in the each catalog, please contact us.

- (1) Aerospace/aviation equipment
- (2) Transportation equipment (electric trains, ships, etc.)
- (3) Medical equipment
- (4) Power-generation control equipment
- (5) Atomic energy-related equipment
- (6) Seabed equipment
- (7) Transportation control equipment

- (8) Public information-processing equipment
- (9) Military equipment
- (10) Electric heating apparatus, burning equipment
- (11) Disaster prevention/crime prevention equipment
- (12) Safety equipment
- (13) Other applications that are not considered general-purpose applications

When designing your equipment even for general-purpose applications, you are kindly requested to take into consideration securing protection circuit/device or providing backup circuits in your equipment.