

BEF-KHS-N02

SICK
Sensor Intelligence.

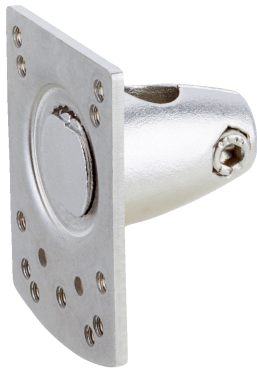

Ordering information

Type	Part no.
BEF-KHS-N02	2051608

Included in delivery: BEF-KHS-KH3 (1)

Other models and accessories → www.sick.com/

Detailed technical data

Technical specifications

Accessory group	Universal bar clamp systems
Material	Zinc plated steel (sheet), Zinc die cast (clamping bracket)
Items supplied	Universal clamp (5322626), mounting hardware
Description	Plate N02 for universal clamp bracket
Usable for	W4S-3 Glass W4SLG-3 W4S-3 Inox W4S-3 Inox Glass W9 W11-2 W12-3 W12-2 Laser W12G W12 Teflon W16 W250 W250-2 PowerProx W11G-2 TranspaTect UC12 P250 G6 Inox W4S-3 Glass W4SL-3V W4SLG-3V W4SL-3H

Classifications

ECl@ss 5.0	27279202
ECl@ss 5.1.4	27279202
ECl@ss 6.0	27279202
ECl@ss 6.2	27279202
ECl@ss 7.0	27279202
ECl@ss 8.0	27279202
ECl@ss 8.1	27279202
ECl@ss 9.0	27273701

ECI@ss 10.0	27273701
ECI@ss 11.0	27273701
ETIM 5.0	EC002024
ETIM 6.0	EC002024
ETIM 7.0	EC002024
ETIM 8.0	EC002024
UNSPSC 16.0901	32131023

Dimensional drawing (Dimensions in mm (inch))

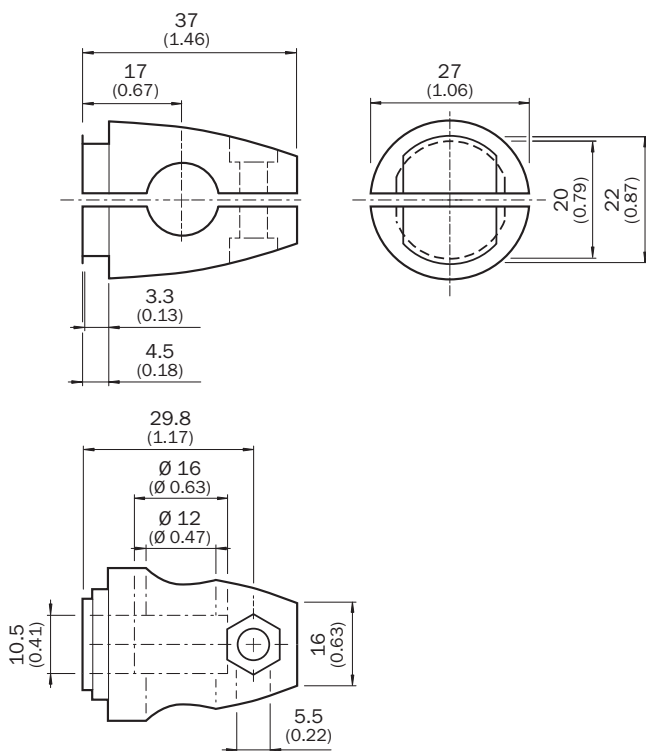



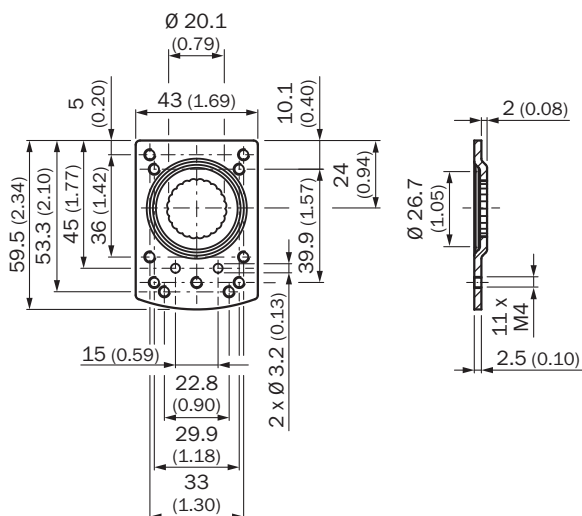

BEF-KHS-KH3



Recommended accessories

Other models and accessories → www.sick.com/

	Brief description	Type	Part no.
Universal bar clamp systems			
	Universal bar clamp for mounting bars with 12 mm diameter, zinc diecast, without mounting plate and screws	BEF-KHS-KH3	5322626
	Ring to connect two clamping brackets 12 mm (clamping brackets 5322626), steel, zinc coated, Ring to connect two bar clamps (bar clamps not included)	BEF-KHS-VR	4075781
	Mounting bar, straight, 300 mm, steel, steel, zinc coated, without mounting hardware	BEF-MS12G-B	4056055
	Bar clamp for bar diameter of 12 mm (fixing the mounting rod), Aluminum, 2 screws M6 x 30, 2 spring discs	BEF-RMC-D12	5321878

SICK AT A GLANCE

SICK is one of the leading manufacturers of intelligent sensors and sensor solutions for industrial applications. A unique range of products and services creates the perfect basis for controlling processes securely and efficiently, protecting individuals from accidents and preventing damage to the environment.

We have extensive experience in a wide range of industries and understand their processes and requirements. With intelligent sensors, we can deliver exactly what our customers need. In application centers in Europe, Asia and North America, system solutions are tested and optimized in accordance with customer specifications. All this makes us a reliable supplier and development partner.

Comprehensive services complete our offering: SICK LifeTime Services provide support throughout the machine life cycle and ensure safety and productivity.

For us, that is “Sensor Intelligence.”

WORLDWIDE PRESENCE:

Contacts and other locations –www.sick.com