

## P/N: 71201-0101

### Copyright

© 2021, FLIR Systems, Inc.

All rights reserved worldwide. Names and marks appearing herein are either registered trademarks or trademarks of FLIR Systems and/or its subsidiaries. All other trademarks, trade names or company names referenced herein are used for identification only and are the property of their respective owners.

### Document identity

Publ. No.: 71201-0101

Commit: 81601

Language:

Modified: 2021-11-30

Formatted: 2021-12-02

### Website

<http://www.flir.com>

### Customer support

<http://support.flir.com>

### Disclaimer

Specifications subject to change without further notice. Camera models and accessories subject to regional market considerations. License procedures may apply. Products described herein may be subject to US Export Regulations. Please refer to [exportquestions@flir.com](mailto:exportquestions@flir.com) with any questions.



General description	
<p>The FLIR AX8 camera/sensor provides an affordable and accurate temperature measurement solution for anyone who needs to solve problems that need built in “smartness” such as analysis, alarm functionality, and autonomous communication using standard protocols. The FLIR AX8 also has all the necessary features and functions to build distributed single- or multi-camera solutions utilizing standard Ethernet hardware and software protocols.</p>	
<p>The FLIR AX8 also has built-in support to connect to industrial control equipment such as PLCs, and allows the sharing of analysis and alarm results and simple control using the Ethernet/IP and Modbus TCP field bus protocols.</p>	
<p>Key features:</p> <ul style="list-style-type: none"> <li>• Support for the EthernetIP field bus protocol (analyze, alarm, and simple camera control).</li> <li>• Support for the Modbus TCP field bus protocol (analyze, alarm, and simple camera control).</li> <li>• Built-in analysis functionality.</li> <li>• Alarm functionality, as a function of analysis and more.</li> <li>• Built-in web server for control and set up.</li> <li>• MJPEG, MPEG-4, or H.264 image streaming.</li> <li>• PoE (Power over Ethernet).</li> <li>• General-purpose output.</li> <li>• 100 Mbps Ethernet (100 m cable).</li> <li>• On alarm: file sending (FTP) or e-mail (SMTP) of analysis results or images.</li> </ul>	
<p>Typical applications:</p> <ul style="list-style-type: none"> <li>• Electrical and mechanical condition-monitoring applications where temperature or temperature trends can be an indication of a potential risk of failure.</li> <li>• Simple process control applications.</li> </ul>	
Imaging and optical data	
IR resolution	80 × 60 pixels
Thermal sensitivity/NETD	< 0.10°C @ +30°C (+86°F) / 100 mK
Field of view (FOV)	48° × 37°
Depth of field	0.1 m (0.33 ft.), infinity
Focal length	1.54 mm (0.061 in.)



## FLIR AX8 9 Hz

P/N: 71201-0101

© 2021, FLIR Systems, Inc.

#71201-0101; r. 81601;

<b>Imaging and optical data</b>	
Spatial resolution (IFOV)	11.1 mrad
F-number	1.1
Image frequency	9 Hz
Focus	Fixed

<b>Detector data</b>	
Detector type	Focal plane array (FPA), uncooled microbolometer
Spectral range	7.5–13 $\mu\text{m}$
Detector pitch	17 $\mu\text{m}$
Detector time constant	Typical 12 ms

<b>Visual camera</b>	
Built-in digital camera	640 × 480
Digital camera, FOV	Adapts to the IR lens
Sensitivity	Minimum 10 lux without illuminator

<b>Measurement</b>	
Object temperature range	–10 to +150°C (14 to +302°F)
Accuracy	$\pm 2^\circ\text{C}$ ( $\pm 3.6^\circ\text{F}$ ) or $\pm 2\%$ of reading (+10 to +100°C @ +10 to +35°C ambient)

<b>Measurement analysis</b>	
Spotmeter	6
Area	6 boxes with max./min./average
Automatic hot/cold detection	Max./min. temperature value and position shown within box
Measurement presets	Yes
Atmospheric transmission correction	Automatic, based on inputs for distance, atmospheric temperature and relative humidity
Optics transmission correction	Automatic, based on signals from internal sensors
Emissivity correction	Variable from 0.01 to 1.0
Reflected apparent temperature correction	Automatic, based on input of reflected temperature
External optics/windows correction	Automatic, based on input of optics/window transmission and temperature
Measurement corrections	Global object parameters

<b>Alarm</b>	
Alarm functions	Automatic alarms on any selected measurement function. A maximum of 5 alarms can be set.
Alarm output	Digital out, store image, file sending (FTP), email (SMTP), notification

P/N: 71201-0101

© 2021, FLIR Systems, Inc.

#71201-0101; r. 81601;

<b>Set-up</b>	
Color palettes	<ul style="list-style-type: none"> <li>• Arctic</li> <li>• Gray</li> <li>• Iron</li> <li>• Lava</li> <li>• Rainbow</li> <li>• Rainbow HC</li> </ul>
Set-up commands	Date/time, Temperature (°C/°F)
Web interface	Yes
<b>Storage of images</b>	
Storage media	Built-in memory for image storage
Image storage mode	IR, visual, MSX
File formats	JPEG + FFF
<b>Image streaming</b>	
Image streaming formats	<ul style="list-style-type: none"> <li>• Motion JPEG stream MJPEG Baseline Process Encoder Baseline ISO/IEC 10918-1 JPEG compliance</li> <li>• MPEG stream Stream format MPEG-4 ISO/IEC 14496-2 Simple Profile level 2</li> <li>• H.264 stream Stream format H.264 Baseline Profile level 2.0</li> </ul>
Image streaming resolution	640 × 480
Image modes	<ul style="list-style-type: none"> <li>• Thermal</li> <li>• Visual</li> <li>• MSX</li> </ul>
Automatic image adjustment	Continuous
Multi Spectral Dynamic Imaging (MSX)	IR image with enhanced detail presentation
<b>Ethernet</b>	
Ethernet	Control, result and image
Ethernet, type	100 Mbps
Ethernet, standard	IEEE 802.3
Ethernet, connector type	M12 8-pin X-coded
Ethernet, communication	TCP/IP socket-based FLIR proprietary
Ethernet, video streaming	Yes
Ethernet, power	Power over Ethernet, PoE IEEE 802.3af class 2.
Ethernet, protocols	Ethernet/IP, Modbus TCP, TCP, UDP, SNMP, RTSP, RTP, HTTP, ICMP, IGMP, sftp, SMTP, DHCP, MDNS (Bonjour)
<b>Digital input/output</b>	
Digital input, purpose	NUC, NUC disable, Alarm
Digital input	1 opto-isolated, 10–25 VDC
Digital output, purpose	As function of alarm, output to ext. device (programmatically set)
Digital output	1 opto-isolated, 10–25 VDC, max. 100 mA
Digital I/O, isolation voltage	500 VRMS
Digital I/O, supply voltage	10-25 VDC, max. 200 mA
Digital I/O, connector type	M12 8-pin A-coded (shared with ext. power)



## FLIR AX8 9 Hz

P/N: 71201-0101

© 2021, FLIR Systems, Inc.

#71201-0101; r. 81601;

Power system	
External power operation	12/24 VDC, 2 W continuously/ 4.7 W absolute max
External power, connector type	M12 8-pin A-coded (Shared with digital I/O)
Voltage	Allowed range 10.8–30 VDC
Power supply rating	Class 2 / LPS

Environmental data	
Operating temperature range	–0°C to +50°C (+32°F to +122°F)
Storage temperature range	–40°C to +70°C (–40°F to +158°F) according to IEC 68-2-1 and IEC 68-2-2
Humidity (operating and storage)	IEC 60068-2-30/24 h 95% relative humidity +25°C to +40°C (+77°F to +104°F)/ 2 cycles
EMC	<ul style="list-style-type: none"><li>• EN 61000-6-2:2001 (Immunity)</li><li>• EN 61000-6-3:2001 (Emission)</li><li>• FCC 47 CFR Part 15 Class B (Emission)</li></ul>
Encapsulation	IP 67 (IEC 60529)
Bump	25 g (IEC 60068-2-29)
Vibration	2 g (IEC 60068-2-6)
Declaration of conformity	See: <a href="https://support.flir.com/resources/DoC">https://support.flir.com/resources/DoC</a>

Physical data	
Weight	0.125 kg (0.28 lb.)
Camera size (L × W × H)	<ul style="list-style-type: none"><li>• 54 × 25 × 79 mm (2.1 × 1 × 3.1 in.) without connectors</li><li>• 54 × 25 × 95 mm (2.1 × 1 × 3.7 in.) with connectors</li></ul>
Base mounting	4× mounting hole depth max 4.8 mm for screw type Delta PT 22 (ø2.2 mm)
Housing material	PA6 with 30% GF (glass fiber reinforced)

Shipping information	
Packaging, type	Cardboard box
List of contents	<ul style="list-style-type: none"><li>• Infrared camera with lens</li><li>• Cardboard box</li><li>• Printed documentation</li></ul>
Packaging, weight	0.48 kg (1.06 lb.)
Packaging, size	210 × 142 × 70 mm (8.27 × 5.59 × 2.76 in.)
EAN-13	4743254001725
UPC-12	845188009373
Country of origin	Estonia

### Supplies & accessories:

- T131367; FLIR Bridge
- T131368; FLIR Bridge power supply
- T131369; FLIR Bridge Pro
- T131370; FLIR Bridge Pro power supply
- T130086; I/O module MIO-AX8-1
- T130087; I/O module MIO-AX8-7
- T199713; ThermoVision CM Panel, max. 4 cameras
- T199712; ThermoVision CM Panel, max. 9 cameras
- T130169; Thermovision CM, max. 4 cameras



## FLIR AX8 9 Hz

---

**P/N: 71201-0101**

© 2021, FLIR Systems, Inc.

#71201-0101; r. 81601;

- T130170; Thermovision CM, max. 9 cameras
- T129259ACC; Cable M12 to pigtail, 10 m
- T129258ACC; Cable M12 to pigtail, 5 m
- T129886ACC; Cable M12, FLIR X-Coded to standard X-Coded
- T128391ACC; Cable, M12 to pigtail
- T198821; Cooling bracket
- T129257ACC; Ethernet cable M12 to RJ45, 10 m
- T128390ACC; Ethernet cable M12 to RJ45, 2 m
- T129256ACC; Ethernet cable M12 to RJ45, 5 m
- 71200-0002; FLIR AX8 accessory starter kit
- T199163; Front mounting plate kit (incl. cooling bracket)
- T199342; One-ball joint mounting bracket kit
- T199343; PoE injector, 12/24 V
- T128775ACC; Rear mounting plate kit
- T199341; Two-ball joint mounting bracket kit

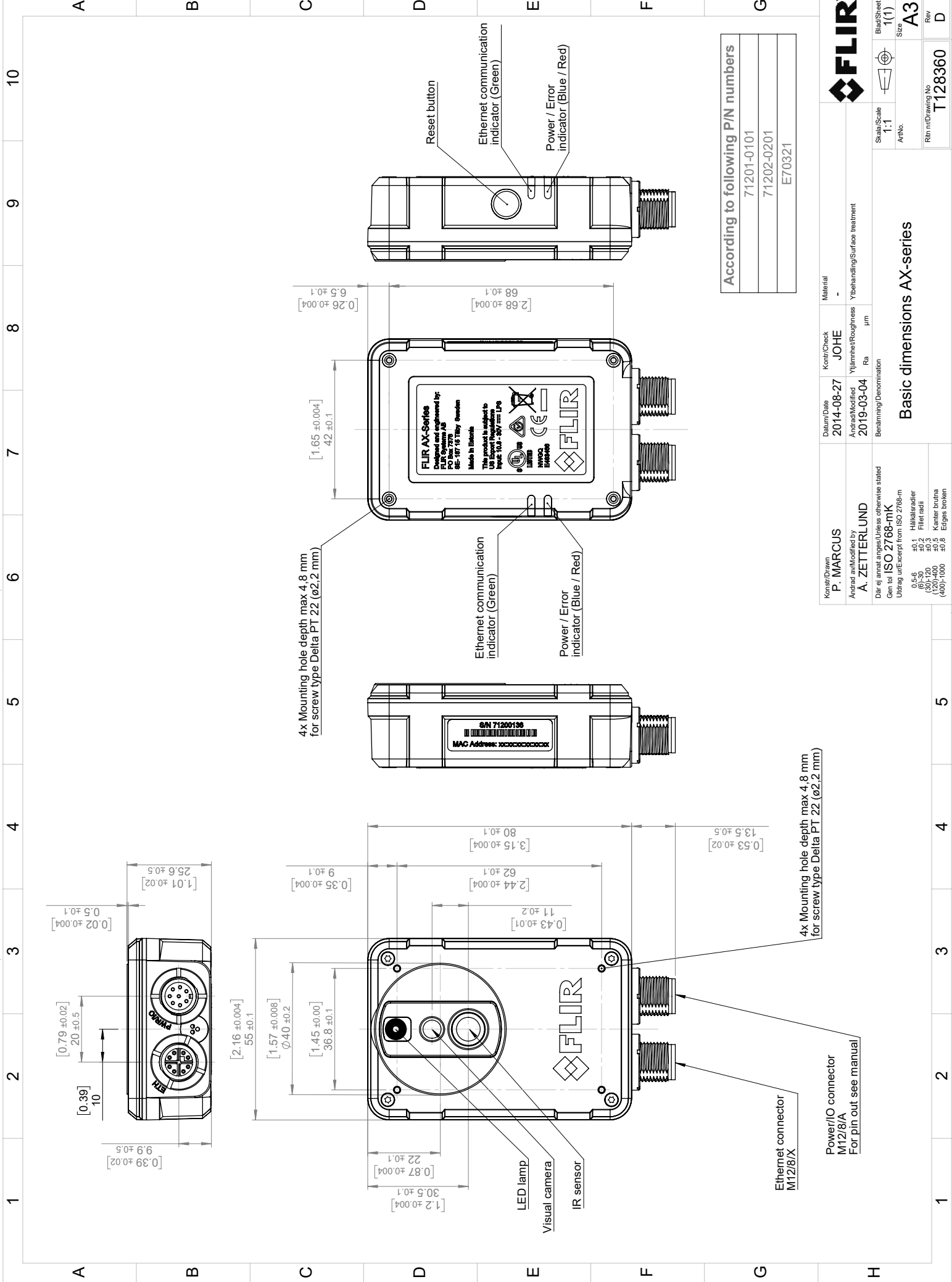

**According to following P/N numbers**

71201-0101
71202-0201
E70321

<b>FLIR</b>		Material	
Konstr/Drawn <b>P. MARCUS</b>		Kontr/Check <b>JOHE</b>	
Datum/Date <b>2014-08-27</b>		Ytbehandling/Surface treatment Ra	
Ändrad av/Modified by <b>A. ZETTERLUND</b>		Ytämnhet/Roughness µm	
Ändrad av/Modified by <b>A. ZETTERLUND</b>		Benämning/Denomination Basic dimensions AX-series	
Dir ej ansvarar för fel som inte är uttryckligen angivna Gen tolk ISO 2768-mK		Skala/Scale 1:1	
Utdrag ur/Excerpt from ISO 2768-m		Aritm. 1(1)	
0.5-6 ±0.1 Hållarsradier		Blad/Sheet 1(1)	
6.3-30 ±0.2 Fillet radii		Size A3	
120-400 ±0.5 Kantar brutna		Rev D	
400-1000 ±0.8 Edges broken		Rit nr/Drawing No T128360	



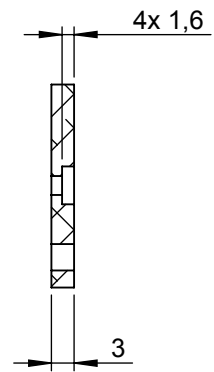
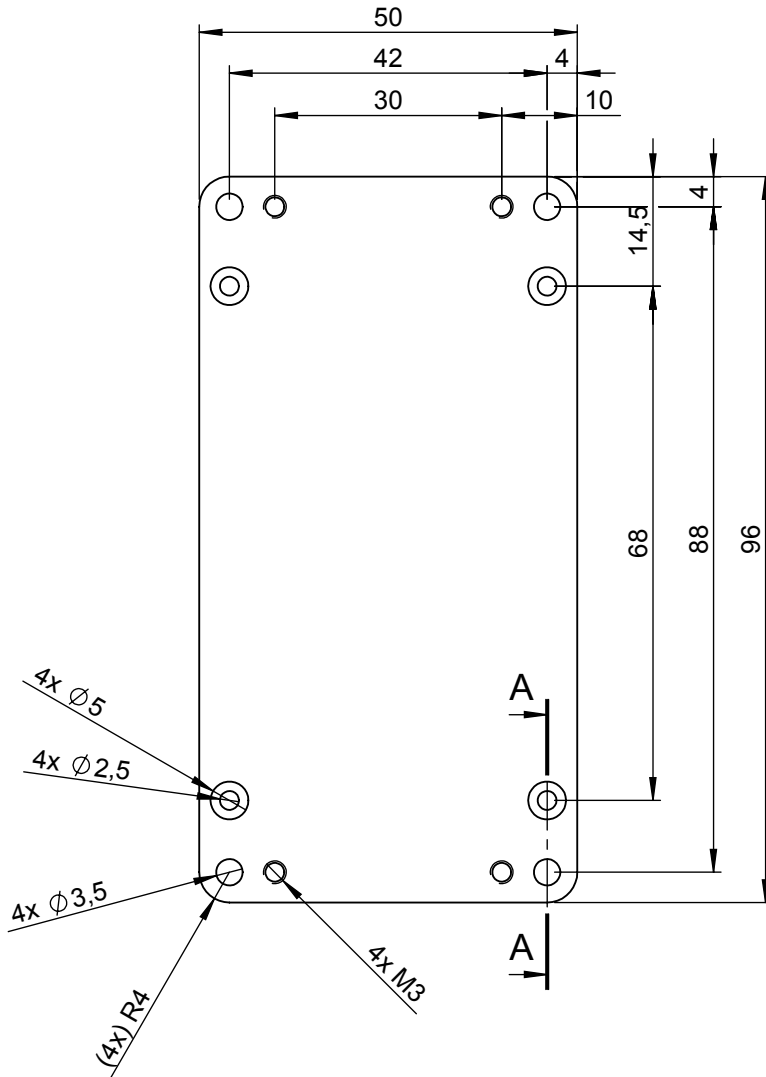

SECTION A-A

Konstr/Drawn <b>J. MÄKINEN</b>	Datum/Date <b>2015-03-06</b>	Kontr/Check <b>HAOS</b>	Material <b>EN AW-5052 or EN AW-5754</b>		
Ändrad av/Modified by <b>J. MÄKINEN</b>	Ändrad/Modified <b>2015-05-21</b>	Ytjämnhet/Roughness Ra      µm	Ytbehandling/Surface treatment		
Där ej annat anges/Unless otherwise stated Gen tol <b>ISO 2768-mK</b> Utdrag ur/Excerpt from ISO 2768-m	Benämning/Denomination <b>Plate mounting rear</b>			Skala/Scale <b>1:1</b>	Blad/Sheet <b>1(1)</b>
0,5-6      ±0,1      Hålkålsradier (6)-30    ±0,2      Fillet radii (30)-120 ±0,3 (120)-400 ±0,5      Kanter brutna (400)-1000 ±0,8      Edges broken				Art.No.	Size <b>A4</b>
				Ritn nr/Drawing No <b>T128775</b>	Rev <b>A</b>



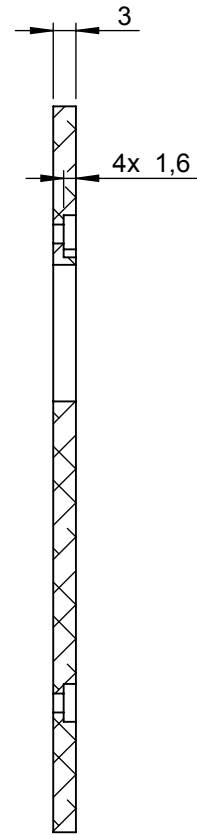
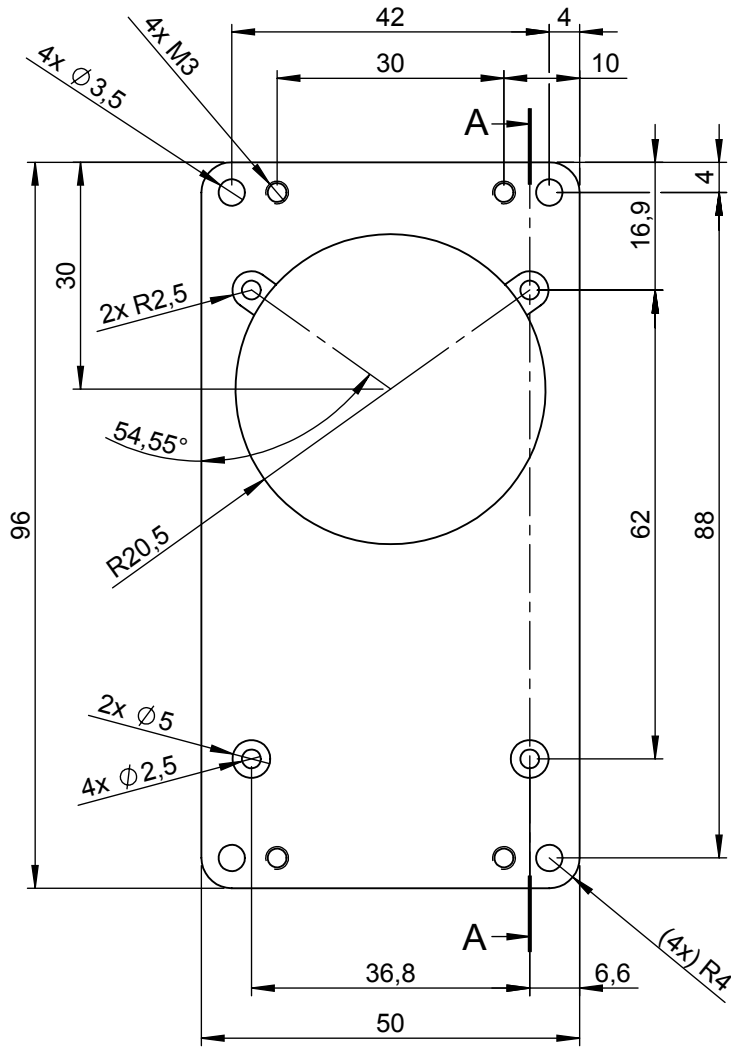

Konstr/Drawn <b>J. MÄKINEN</b>	Datum/Date <b>2015-03-06</b>	Kontr/Check <b>HAOS</b>	Material <b>EN AW-5052 or EN AW-5754</b>	
Ändrad av/Modified by <b>J. MÄKINEN</b>	Ändrad/Modified <b>2015-05-21</b>	Ytjämnhet/Roughness Ra      µm	Ytbehandling/Surface treatment	
Där ej annat anges/Unless otherwise stated Gen tol <b>ISO 2768-mK</b> Utdrag ur/Excerpt from ISO 2768-m	Benämning/Denomination <b>Plate mounting front</b>		Skala/Scale <b>1:1</b>	Blad/Sheet <b>1(1)</b>
0,5-6 ±0,1 Hålkälsradier (6)-30 ±0,2 Fillet radii (30)-120 ±0,3 (120)-400 ±0,5 Kanter brutna (400)-1000 ±0,8 Edges broken			Art.No.	Size <b>A4</b>
			Ritn nr/Drawing No <b>T128774</b>	Rev <b>A</b>

RoHS

IP67

REV.	DESCRIPTION	DATE
A	ISSUE	Dec/23/2013
B	Modify the wire diagram.	Dec/25/2013
C	Modify M12 Pin Assignment.	Dec/25/2013
D	Modify cable length.	Dec/25/2013
D1	Correct key direction.	Jan/22/2014
E	Add note.	Mar/30/2014
F	Modify P/N.	Sep/25/2014
G	Modify connector to shielding type.	Nov/12/2014
G1	Change ring nut to shielding type.	Nov/25/2014

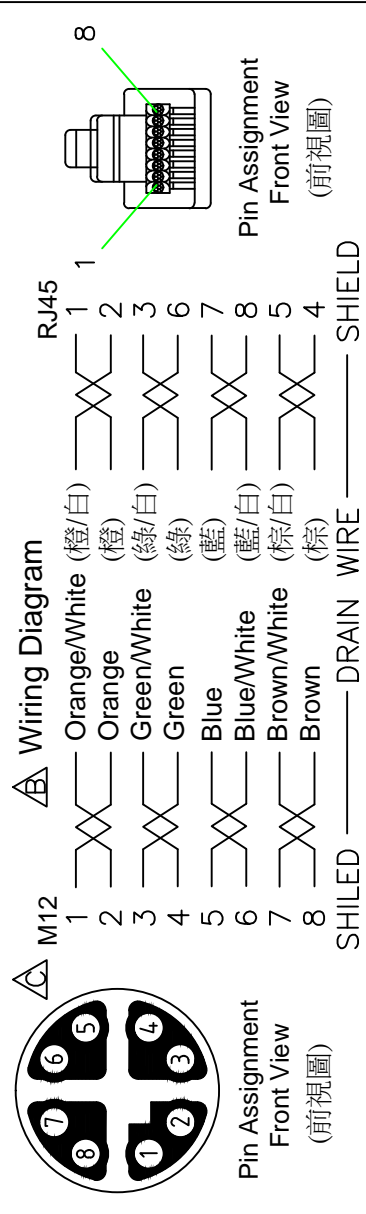
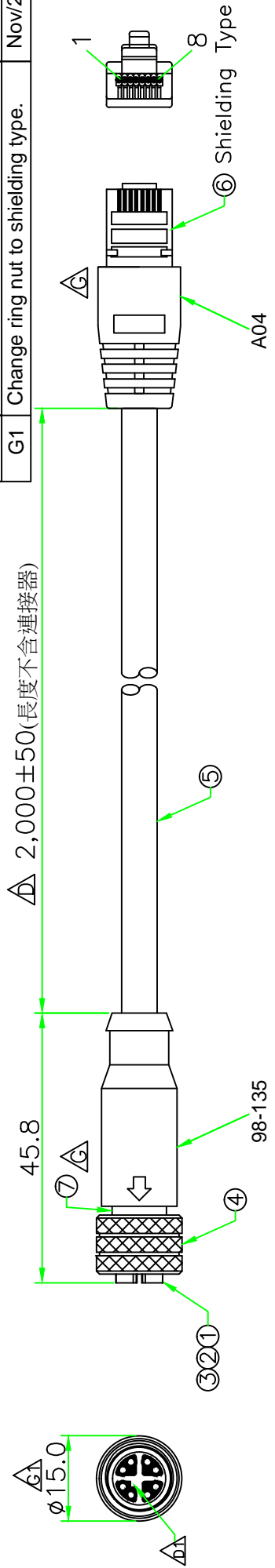

7	SHIELD	Brass, Nickel Plated.	1		
6	RJ45 PLUG	RJ45 8P8C PLUG (shielding type).	1		
5	CABLE	CAT5E FTP 24AWG x 4 PAIR + AL/MY + Drain wire.	1	WAC2B0026	
4	RING NUT	Brass, Nickel Plated.	1	M12S-RN-D985	
3	O-RING	Viton.	1	M12-O-VK	
2	CONTACT	Brass, Female pin, .6 u" Gold plated.	8	AASPF-1008-0.8	
1	CONNECTOR	M12 X-coding Female connector insert. Nylon+GF.	1	M12X-08F	
No.	PART NAME	DESCRIPTION	Q'TY	REMARKS	COLOR

Customer: FLIR

TITLE	UNIT: mm	SCALE	UNLESS OTHERWISE SPECIFIED TOLERANCES:
M12 X-Coding Female Molded Cable Assy	1:1	1:1	XXX ± 0.05 ANGLE ± 1°X
P/N:			XX ± 0.1
DWG.NO:			X ± 0.25
			REV. SHEET

DR.	Stanley
CH.	ERIC
AP.	

G1	1/1
T128390	

RoHS

IP67

REV.	DESCRIPTION	DATE
A	ISSUE	Dec/23/2013
B	Modify cable length.	Dec/25/2013
C	Add note.	Mar/20/2014
D	Modify P/N.	Sep/25/2014
E	Modify connector to shielding type.	Nov/12/2014
E1	Change ring nut to shielding type.	Nov/25/2014

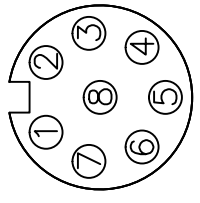
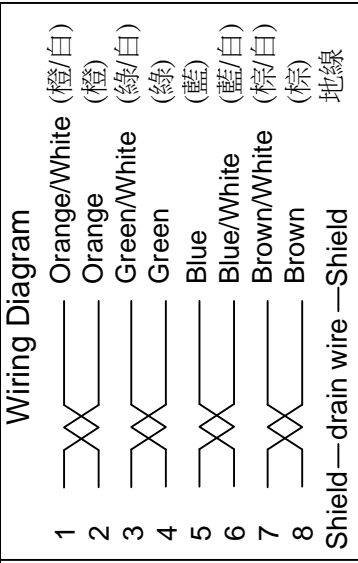
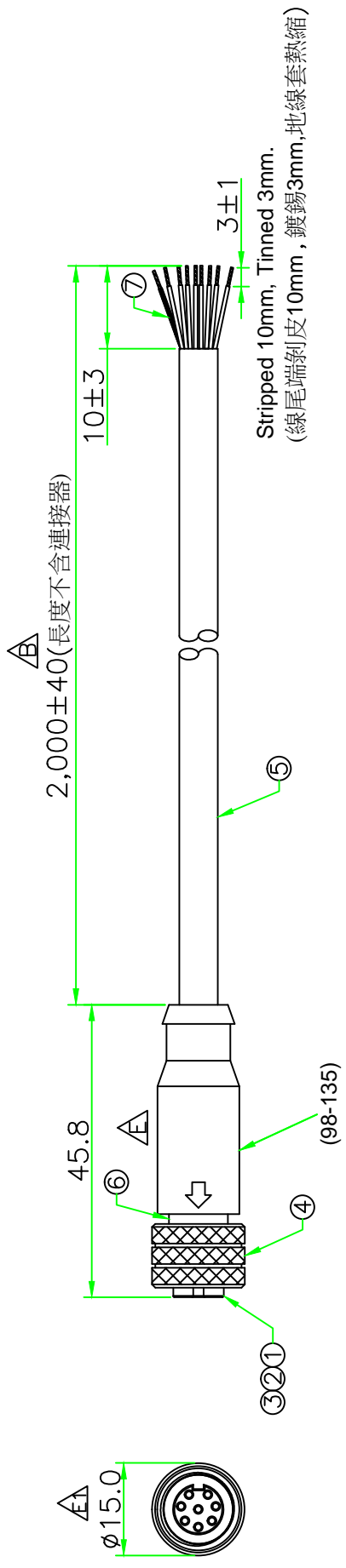

7	TUBE	Heat shrink tube.	BLACK	1	
6	SHIELD	Brass, Nickel Plated. $\Delta$		1	
5	CABLE	CAT5E FTP 24AWG x 4 PAIR + AL/MY + Drain wire.	BLACK	1	WAC2B0026
4	RING NUT	Brass, Nickel Plated.		1	M12S-RN-D985
3	O-RING	Viton.	BLACK	1	M12-O-VK
2	CONTACT	Brass, Female pin, 6 u" Gold plated.		8	AASPF-1008-0.8
1	CONNECTOR	M12 A-coding Female connector insert. Nylon+GF.	BLACK	1	M12A-08F
No.	PART NAME	DESCRIPTION	COLOR	Q'TY	REMARKS

Customer: FLIR

	UNIT: mm	SCALE	1:1	TITLE	M12 A-Coding 8P Female Molded Cable Assy
UNLESS OTHERWISE SPECIFIED TOLERANCES:		P/N:			
X ± 0.25	XX ± 0.1	K129351003			
XXX ± 0.05	ANGLE ± 1°X	DR. <i>Stanley</i>			
REV.	SHEET	DWG. NO:			
E1	1/1	CH. <i>ERJC</i>			
		AP.			

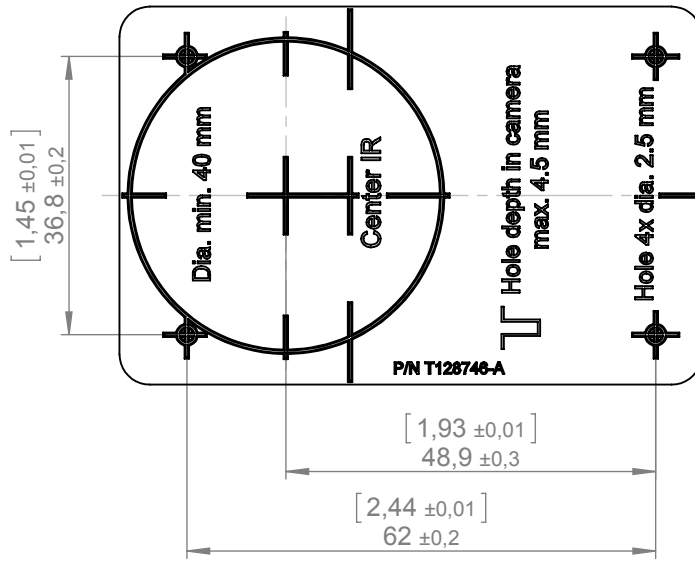

Scale 1:1

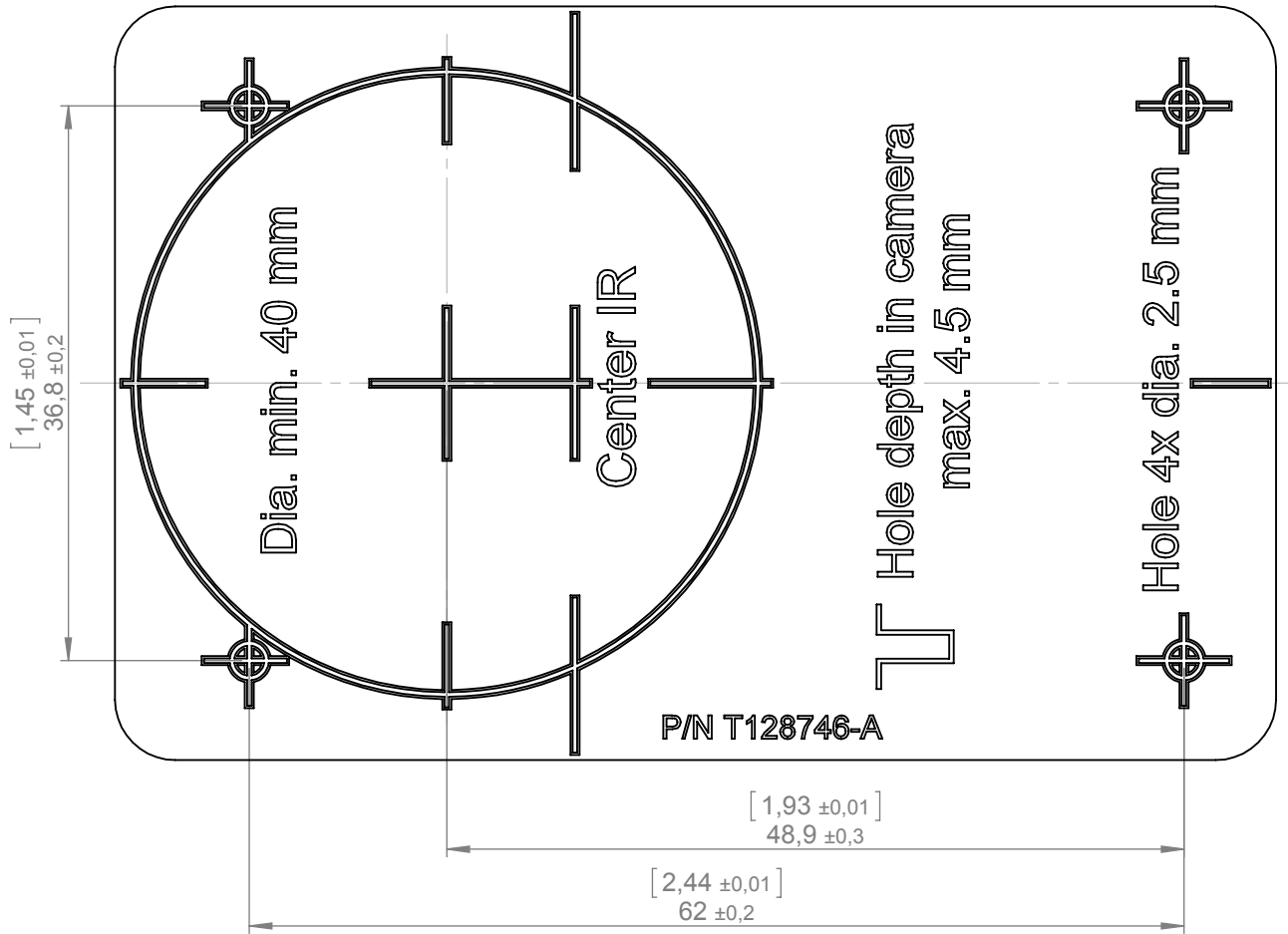

Scale 2:1

Konstr/Drawn <b>P. MARCUS</b>	Datum/Date <b>2014-10-06</b>	Kontr/Check <b>JAMA</b>	Material <b>Note 1</b>	
Ändrad av/Modified by <b>P. MARCUS</b>	Ändrad/Modified <b>2015-03-04</b>	Ytjämnhet/Roughness Ra      µm	Ytbehandling/Surface treatment	
Där ej annat anges/Unless otherwise stated Gen tol <b>ISO 2768-mK</b> Utdrag ur/Excerpt from ISO 2768-m	Benämning/Denomination <b>Drilling template front</b>		Skala/Scale <b>2:1</b>	Blad/Sheet <b>2(2)</b>
0,5-6      ±0,1      Hålkälsradier (6)-30    ±0,2      Fillet radii (30)-120 ±0,3 (120)-400 ±0,5      Kanter brutna (400)-1000 ±0,8      Edges broken			Art.No.	Size <b>A4</b>
			Ritn nr/Drawing No <b>T128746</b>	Rev <b>A</b>

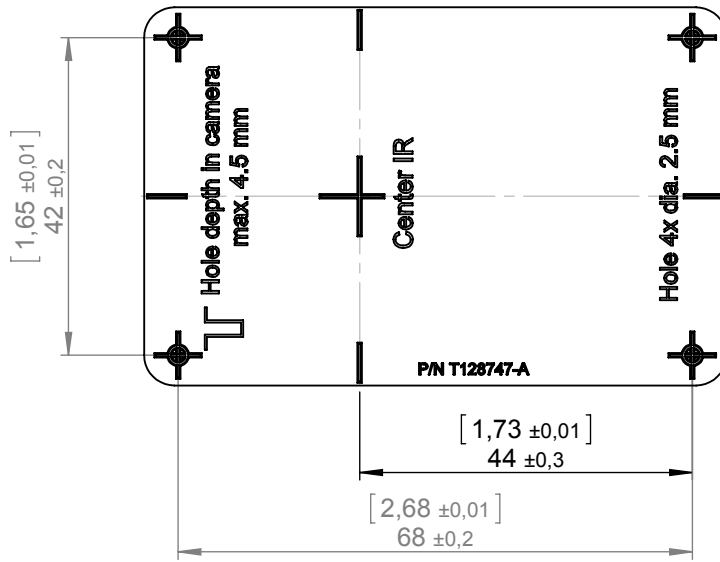

Scale 1:1

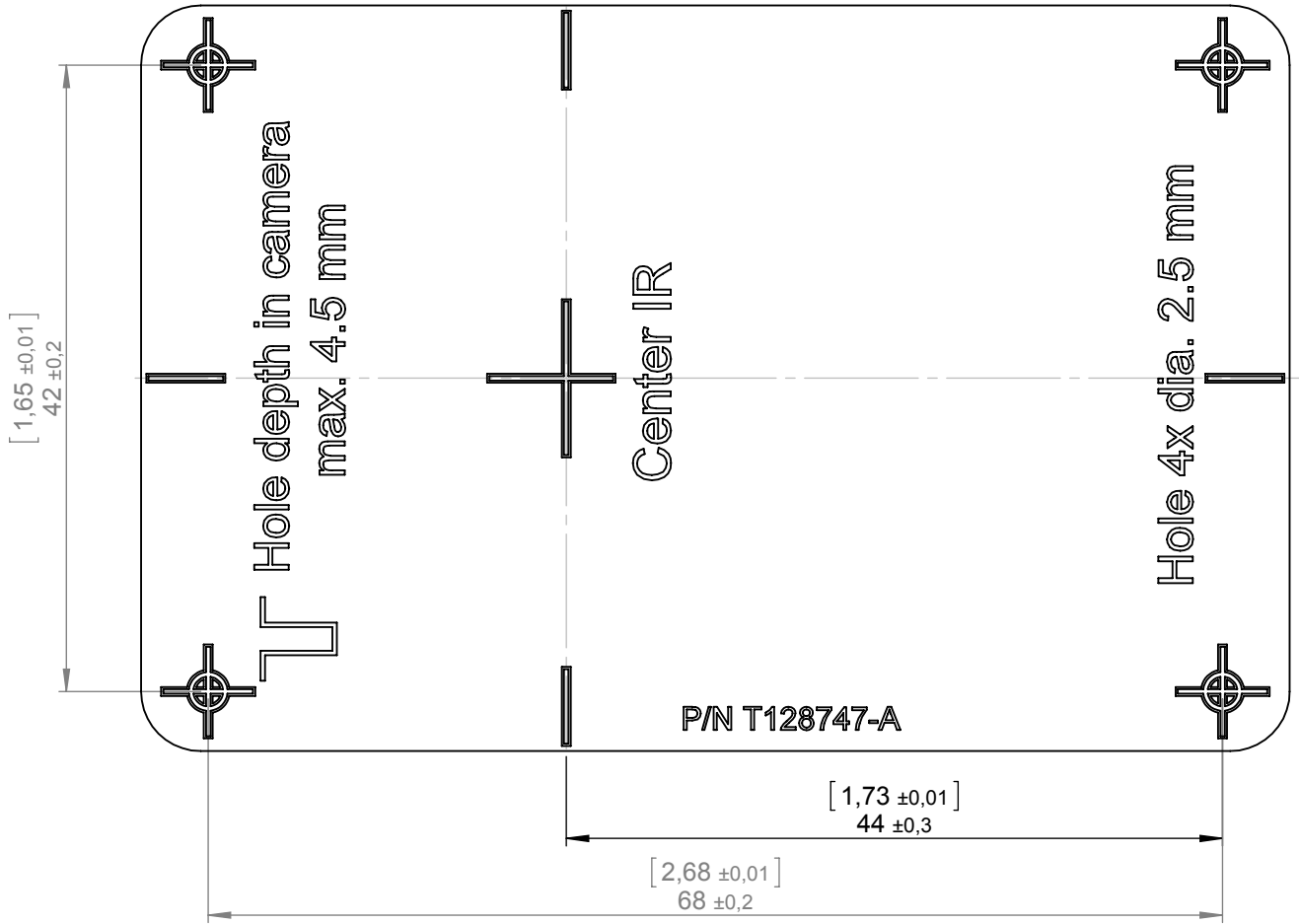

Scale 2:1

Konstr/Drawn <b>P. MARCUS</b>	Datum/Date <b>2014-10-06</b>	Kontr/Check <b>JAMA</b>	Material <b>Note 1</b>		
Ändrad av/Modified by <b>P. MARCUS</b>	Ändrad/Modified <b>2015-03-04</b>	Ytjämnhet/Roughness Ra      μm	Ytbehandling/Surface treatment		
Där ej annat anges/Unless otherwise stated Gen tol <b>ISO 2768-mK</b> Utdrag ur/Excerpt from ISO 2768-m	Benämning/Denomination <b>Drilling template rear</b>			Skala/Scale <b>2:1</b>	Blad/Sheet <b>2(2)</b>
0,5-6      ±0,1      Hålkälsradier (6)-30    ±0,2      Fillet radii (30)-120 ±0,3 (120)-400 ±0,5      Kanter brutna (400)-1000 ±0,8      Edges broken				Art.No.	Size <b>A4</b>
				Ritn nr/Drawing No <b>T128747</b>	Rev <b>A</b>

# Digital I/O connection diagrams FLIR AX8

