

OBSOLETE - PART DISCONTINUED

Description

The AZ1117E is a low-dropout three-terminal regulator with 1.0A output current ability, and the dropout voltage is specified at typical 1.1V at 1.0A current load decreasing at lower load currents.

The AZ1117E is optimized for low voltage where transient response and minimum input voltage are critical. It provides current limit and thermal shutdown protection solutions. Its circuit includes a trimmed band gap reference to assure output voltage accuracy to be within $\pm 1\%$. On-chip thermal shutdown provides protection against a combination of high current and ambient temperature that would create excessive junction temperature.

The AZ1117E is available in 1.2V, 1.5V, 1.8V, 2.5V, 3.3V, and 5.0V fixed-output voltage versions and ADJ output voltage version. The fixed versions integrate the adjust resistors.

The AZ1117E is available in the industry-standard SOT-223 package.

Pin Assignments

(Top View)

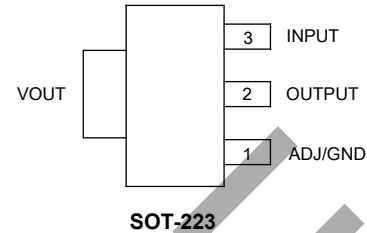

Applications

- TVs and LCD Monitors
- PC Peripherals: Notebooks, Motherboards
- STB

Features

- Provides ADJ Version ($V_{REF} = 1.25V$) and Fixed Voltage 1.2V, 1.5V, 1.8V, 2.5V, 3.3V, and 5.0V with Accuracy $\pm 1\%$ (Except 1.2V)
- Current Limit: 1.3A (Typ.)
- Dropout Voltage: 1.1V (Typ.) @ $I_{OUT} = 1A$
- Regulator Stable with Low ESR MLCC
- Excellent Line Regulation: 0.001%/V (Typ.) @ $I_{OUT} = 30mA$
- Excellent Load Regulation: 0.2%/A @ $I_{OUT} = 1A$
- Quiescent Current: 3.5mA
- Low Output Noise
- PSRR: 70dB
- OTSD Protection
- Operation Junction Temperature: $-40^{\circ}C$ to $+125^{\circ}C$
- **Totally Lead-Free & Fully RoHS Compliant (Notes 1 & 2)**
- **Halogen- and Antimony-Free. "Green" Device (Note 3)**

Notes:

1. No purposely added lead. Fully EU Directive 2002/95/EC (RoHS), 2011/65/EU (RoHS 2) & 2015/863/EU (RoHS 3) compliant.
2. See <https://www.diodes.com/quality/lead-free/> for more information about Diodes Incorporated's definitions of Halogen- and Antimony-free, "Green" and Lead-free.
3. Halogen- and Antimony-free "Green" products are defined as those which contain <900ppm bromine, <900ppm chlorine (<1500ppm total Br + Cl) and <1000ppm antimony compounds.

OBSOLETE - PART DISCONTINUED

Typical Applications Circuit (Note 4)

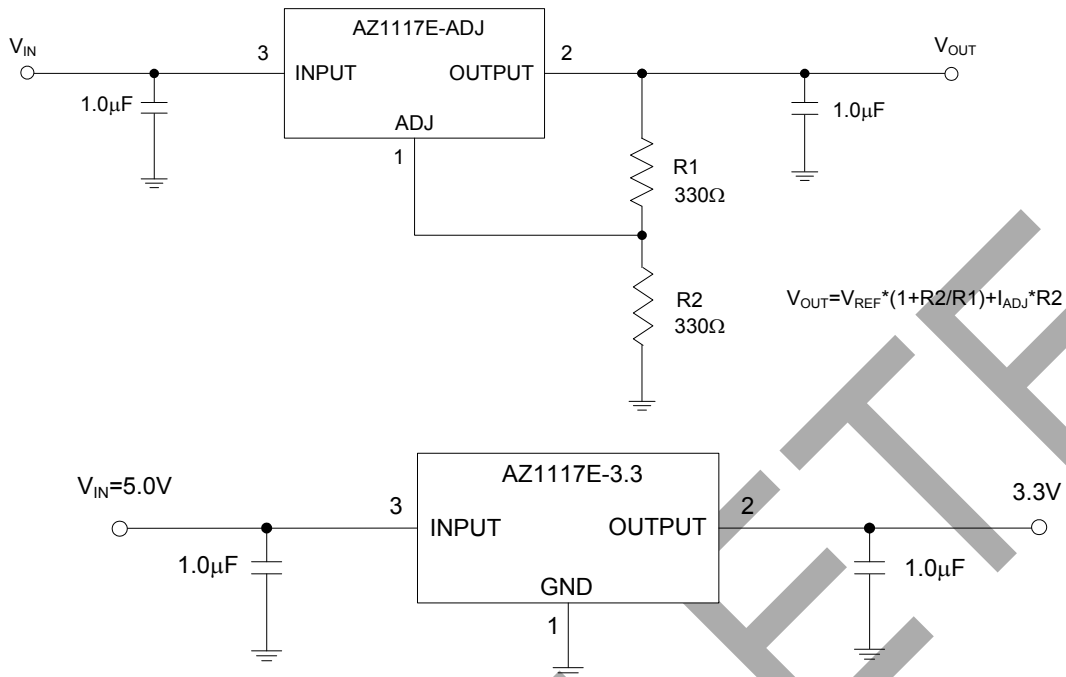

Note: 4. The AZ1117E is compatible with Low ESR ceramic capacitor. A minimum of 1.0µF input and output capacitors are required. The ESR of the output capacitors must be less than 1.5Ω. Close to the OUTPUT pin, it is not recommended to use a capacitor smaller than 0.68µF in parallel with output capacitor. When the output capacitor parallels 0.1µF capacitor, the 0.1µF capacitor must be away from the OUTPUT pin, the distance is no less than 5mm.

Pin Descriptions

Pin Number	Pin Name	Function
1	ADJ/GND	Adjustable Pin or Ground Pin
2	OUTPUT	Regulator Output Pin
3	INPUT	Supply Voltage Pin

Absolute Maximum Ratings (Note 5)

Symbol	Parameter	Rating	Unit
V _{IN}	Power Supply Voltage	16	V
T _J	Operating Junction Temperature Range	+150	°C
T _{STG}	Storage Temperature Range	-65 to +150	°C
T _{LEAD}	Lead Temperature (Soldering, 10sec)	+260	°C
θ _{JA}	Thermal Resistance (Junction to Ambient) (Note 6)	65	°C/W
—	ESD (Machine Model)	200	V
—	ESD (Human Body Model)	2000	V

Notes: 5. Stresses greater than those listed under *Absolute Maximum Ratings* may cause permanent damage to the device. These are stress ratings only, and functional operation of the device at these or any other conditions beyond those indicated under *Recommended Operating Conditions* is not implied. Exposure to *Absolute Maximum Ratings* for extended periods may affect device reliability.
6. Chip is soldered to 200mm² (16mm × 12.5mm) copper (top side solder mask) on 2oz. two layers FR-4 PCB with 8 × 0.5mm vias.

OBsolete - PART DISCONTINUED

Recommended Operating Conditions

Symbol	Parameter	Min	Max	Unit
V _{IN}	Supply Voltage	—	13	V
T _J	Operating Junction Temperature Range	-40	+125	°C

Electrical Characteristics (@ V_{IN} = V_{OUT}+1.5V, C_{IN} = 1.0µF (Ceramic), C_{OUT} = 1.0µF (Ceramic), Typical T_A = +25°C, **Bold** typeface applies over -40°C ≤ T_J ≤ +125°C ranges, unless otherwise specified.)

Symbol	Parameter	Conditions	Min	Typ	Max	Unit
V _{REF}	Reference Voltage	V _{OUT} + 1.5V ≤ V _{IN} ≤ 12V, I _{OUT} = 10mA	1.238	1.250	1.262	V
			98% × V_{OUT}	V _{OUT}	102% × V_{OUT}	V
V _{OUT}	Output Voltage (Fixed Versions)	For 1.2V, V _{OUT} + 1.5V ≤ V _{IN} ≤ 12V, I _{OUT} = 10mA	98% × V _{OUT}	V _{OUT}	102% × V _{OUT}	V
			96% × V_{OUT}	V_{OUT}	104% × V_{OUT}	V
		For 1.5V to 5V, V _{OUT} +1.5V ≤ V _{IN} ≤ 12V, I _{OUT} = 10mA	99% × V _{OUT}	V _{OUT}	101% × V _{OUT}	V
			98% × V_{OUT}	V _{OUT}	102% × V_{OUT}	V
V _{DROP}	Dropout Voltage	I _{OUT} = 1A	—	1.1	1.3	V
I _{OUT(MAX)}	Maximum Output Current	1.5V ≤ V _{IN} -V _{OUT}	1	1.3	—	A
V _{RLOAD}	Load Regulation	V _{IN} = V _{OUT} +1.5V 1mA ≤ I _{OUT} ≤ 1A	—	0.2	0.6	%/A
V _{RLINE}	Line Regulation	1.5V ≤ V _{IN} - V _{OUT} ≤ 10V, I _{OUT} = 30mA	—	0.001	±0.04	%/V
I _Q	Quiescent Current	For Fixed Voltage Version, I _{OUT} = 0	—	3.5	6	mA
—	Minimum Load Current	For ADJ Version, 1.5V ≤ V _{IN} -V _{OUT} ≤ 10V	—	2	5	mA
I _{ADJ}	Adjustable Pin Current	—	—	45	90	µA
—	Adjustable Pin Current Change	1.5V ≤ V _{IN} -V _{OUT} ≤ 10V	—	0.2	5	µA
PSRR	Power Supply Rejection Ratio	Ripple 1.0 Vp-p V _{IN} = V _{OUT} + 2V, I _{OUT} = 100mA	—	70	—	dB
			—	70	—	
$\frac{\Delta V_{OUT}}{V_{OUT}} / \Delta T$	Output Voltage Temperature Coefficient	I _{OUT} = 30mA	—	±30	—	—
V _{NOISE}	RMS Output Noise	10Hz ≤ f ≤ 100kHz, No Load	—	0.003	—	—
T _{OTSD}	Thermal Shutdown Temperature	—	—	+170	—	—
T _{HYOTSD}	Thermal Shutdown Hysteresis	—	—	+20	—	—
θ _{JC}	Thermal Resistance (Junction to Case)	SOT-223	—	40	—	—

OBSOLETE - PART DISCONTINUED

Performance Characteristics

Line Regulation vs. Temperature

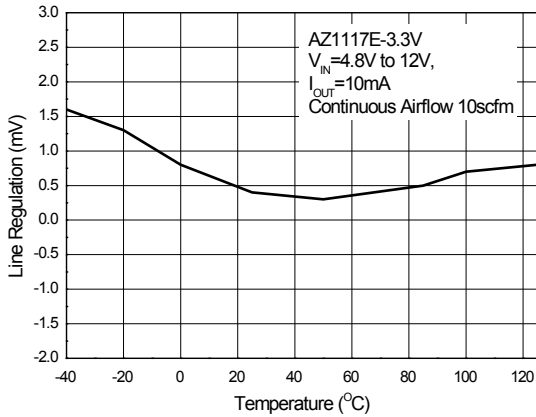

Load Regulation vs. Temperature

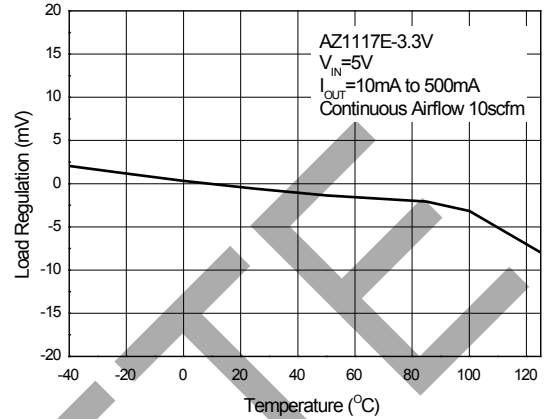

Reference Voltage vs. Temperature

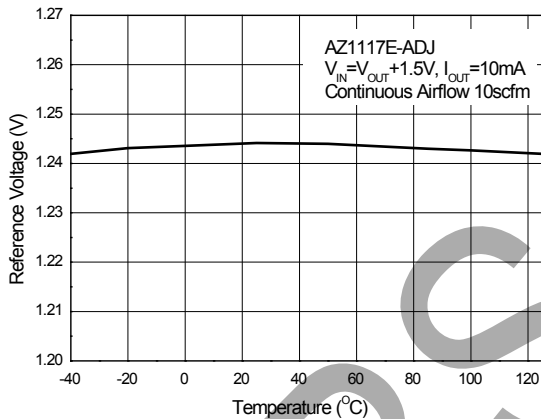

Output Voltage vs. Temperature

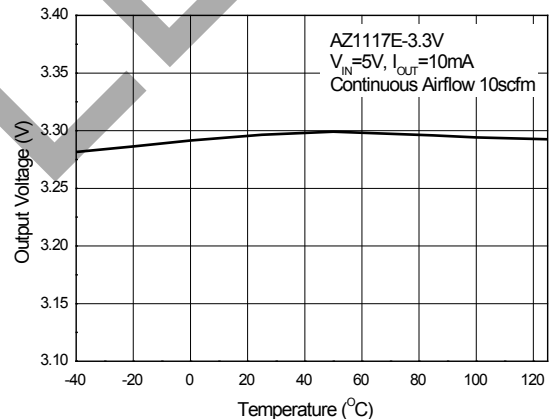

Minimum Load Current vs. Temperature

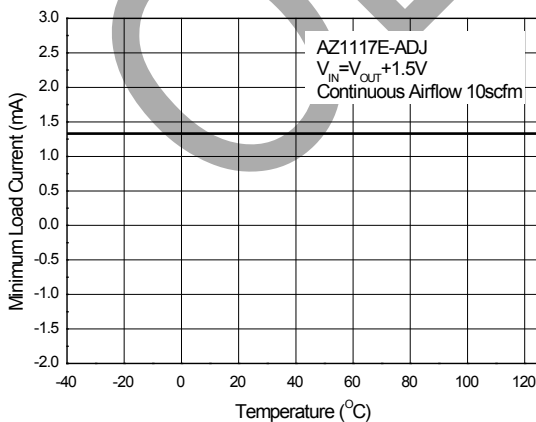

Adjust Pin Current vs. Temperature

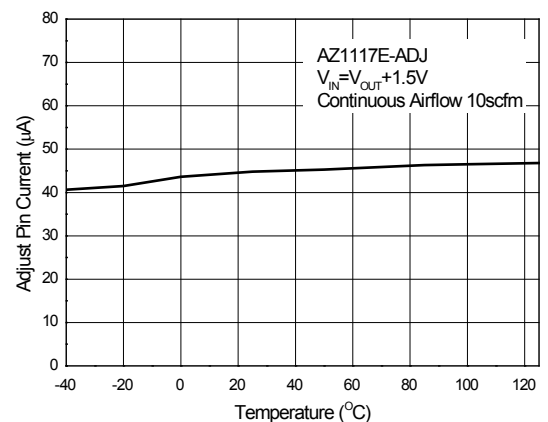

Performance Characteristics (continued)

Dropout Voltage vs. Output Current

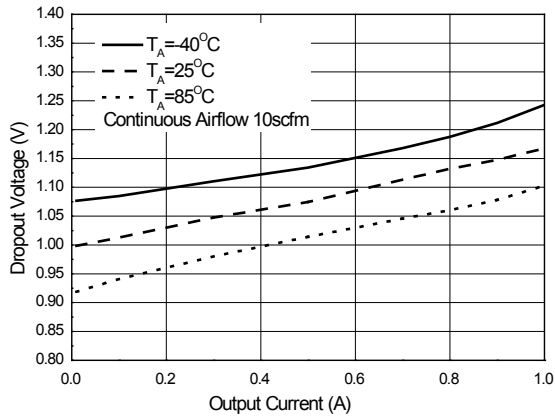

Dropout Voltage vs. Temperature

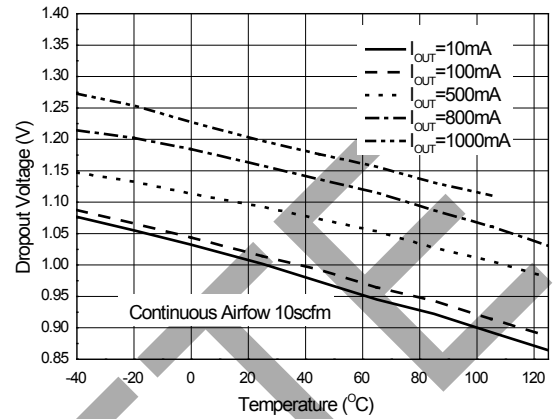

Output Voltage vs. Output Current

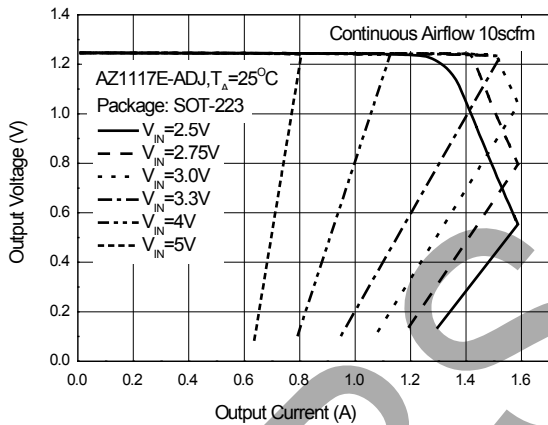

Output Voltage vs. Output Current

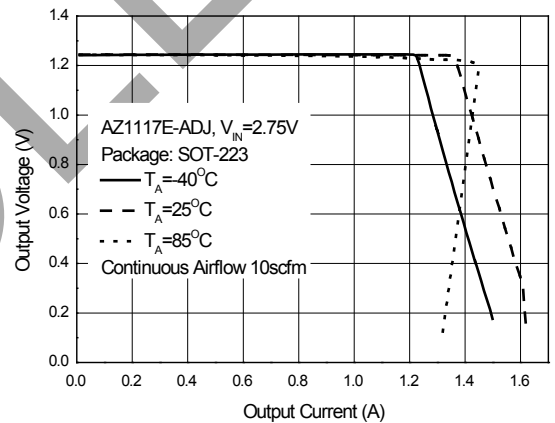

PSRR vs. Frequency

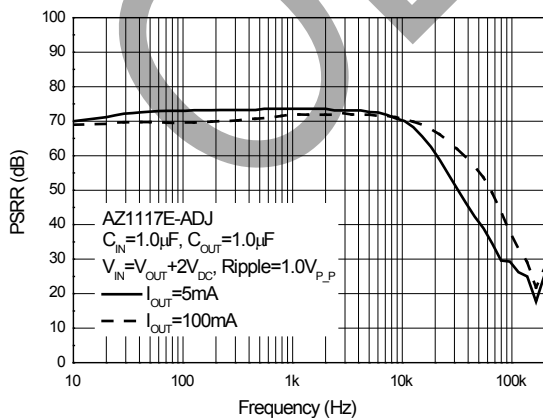

Current Limit vs. Temperature

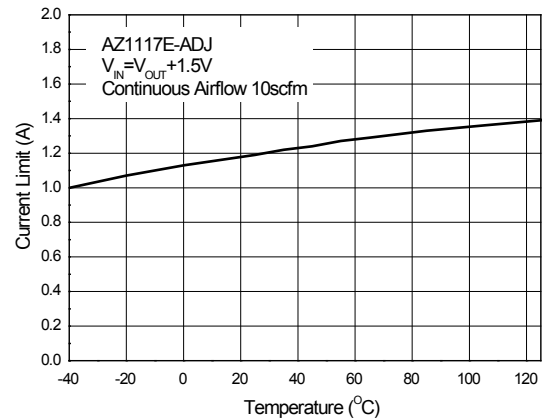

OBSOLETE - PART DISCONTINUED

Performance Characteristics (cont.)

Load Transient Response

(AZ1117E-ADJ, $V_{IN}=5V$, $V_{OUT}=3.3V$,

$C_{IN}=1.0\mu F$, $C_{OUT}=1.0\mu F$)

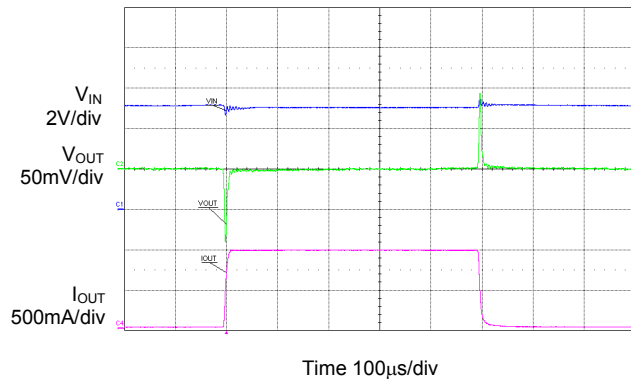

OBSOLETE - PART DISCONTINUED

OBSOLETE

OBSOLETE - PART DISCONTINUED

Ordering Information

AZ1117E X - XX XX XX

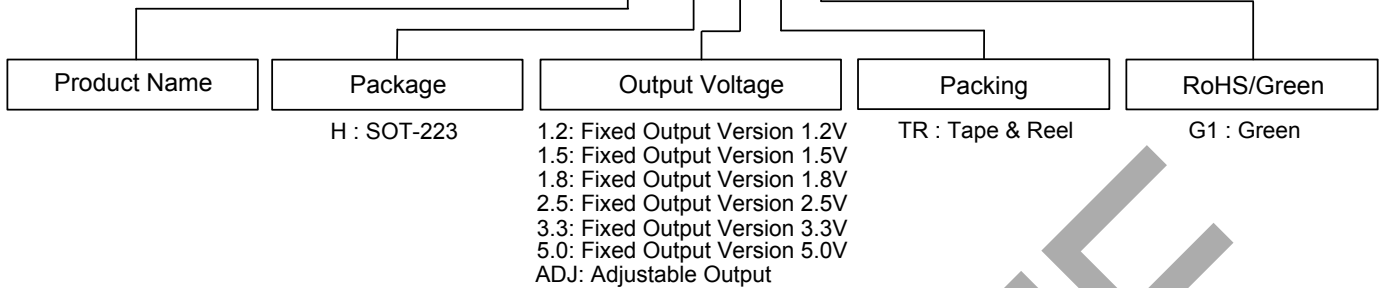

Package	Temperature Range	Part Number	Marking ID	Packing
SOT-223	-40°C to +125°C	AZ1117EH-1.2TRG1	GH23F	4000/Tape & Reel
		AZ1117EH-1.5TRG1	GH27F	4000/Tape & Reel
		AZ1117EH-1.8TRG1	GH18G	4000/Tape & Reel
		AZ1117EH-2.5TRG1	GH23G	4000/Tape & Reel
		AZ1117EH-3.3TRG1	GH27G	4000/Tape & Reel
		AZ1117EH-5.0TRG1	GH18H	4000/Tape & Reel
		AZ1117EH-ADJTRG1	GH23H	4000/Tape & Reel

Marking Information

SOT-223 Series

(Top View)

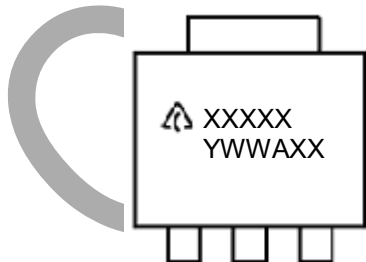

First Line: Logo and Marking ID
(See Ordering Information)
Second Line: Date Code
Y: Year
WW: Work Week of Molding
A: Assembly House Code
XX: 7th and 8th Digits of Batch Number

OBSOLETE - PART DISCONTINUED

Package Outline Dimensions

Please see <http://www.diodes.com/package-outlines.html> for the latest version.

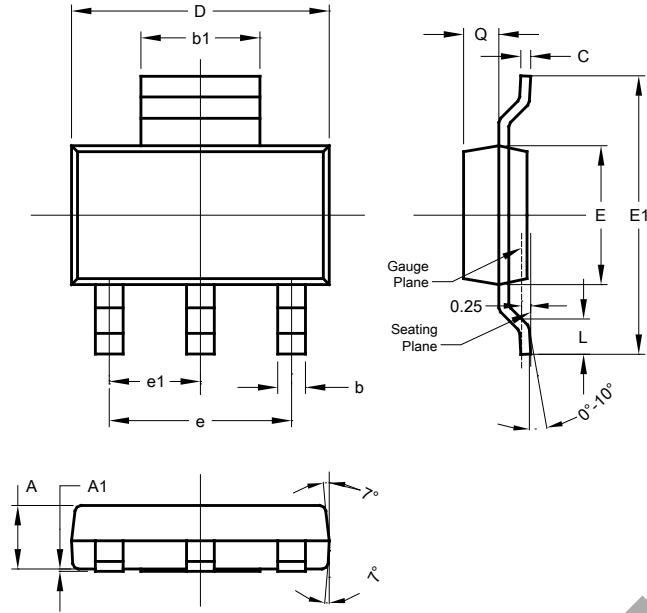

SOT223			
Dim	Min	Max	Typ
A	1.55	1.65	1.60
A1	0.010	0.15	0.05
b	0.60	0.80	0.70
b1	2.90	3.10	3.00
C	0.20	0.30	0.25
D	6.45	6.55	6.50
E	3.45	3.55	3.50
E1	6.90	7.10	7.00
e	-	-	4.60
e1	-	-	2.30
L	0.85	1.05	0.95
Q	0.84	0.94	0.89
All Dimensions in mm			

Suggested Pad Layout

Please see <http://www.diodes.com/package-outlines.html> for the latest version.

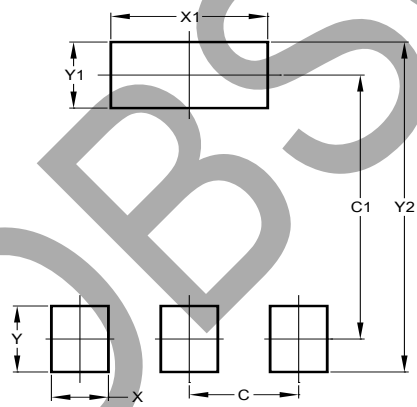

Dimensions	Value (in mm)
C	2.30
C1	6.40
X	1.20
X1	3.30
Y	1.60
Y1	1.60
Y2	8.00

IMPORTANT NOTICE

1. DIODES INCORPORATED AND ITS SUBSIDIARIES ("DIODES") MAKE NO WARRANTY OF ANY KIND, EXPRESS OR IMPLIED, WITH REGARDS TO ANY INFORMATION CONTAINED IN THIS DOCUMENT, INCLUDING, BUT NOT LIMITED TO, THE IMPLIED WARRANTIES OF MERCHANTABILITY, FITNESS FOR A PARTICULAR PURPOSE OR NON-INFRINGEMENT OF THIRD PARTY INTELLECTUAL PROPERTY RIGHTS (AND THEIR EQUIVALENTS UNDER THE LAWS OF ANY JURISDICTION).
2. The Information contained herein is for informational purpose only and is provided only to illustrate the operation of Diodes products described herein and application examples. Diodes does not assume any liability arising out of the application or use of this document or any product described herein. This document is intended for skilled and technically trained engineering customers and users who design with Diodes products. Diodes products may be used to facilitate safety-related applications; however, in all instances customers and users are responsible for (a) selecting the appropriate Diodes products for their applications, (b) evaluating the suitability of the Diodes products for their intended applications, (c) ensuring their applications, which incorporate Diodes products, comply the applicable legal and regulatory requirements as well as safety and functional-safety related standards, and (d) ensuring they design with appropriate safeguards (including testing, validation, quality control techniques, redundancy, malfunction prevention, and appropriate treatment for aging degradation) to minimize the risks associated with their applications.
3. Diodes assumes no liability for any application-related information, support, assistance or feedback that may be provided by Diodes from time to time. Any customer or user of this document or products described herein will assume all risks and liabilities associated with such use, and will hold Diodes and all companies whose products are represented herein or on Diodes' websites, harmless against all damages and liabilities.
4. Products described herein may be covered by one or more United States, international or foreign patents and pending patent applications. Product names and markings noted herein may also be covered by one or more United States, international or foreign trademarks and trademark applications. Diodes does not convey any license under any of its intellectual property rights or the rights of any third parties (including third parties whose products and services may be described in this document or on Diodes' website) under this document.
5. Diodes products are provided subject to Diodes' Standard Terms and Conditions of Sale (<https://www.diodes.com/about/company/terms-and-conditions/terms-and-conditions-of-sales/>) or other applicable terms. This document does not alter or expand the applicable warranties provided by Diodes. Diodes does not warrant or accept any liability whatsoever in respect of any products purchased through unauthorized sales channel.
6. Diodes products and technology may not be used for or incorporated into any products or systems whose manufacture, use or sale is prohibited under any applicable laws and regulations. Should customers or users use Diodes products in contravention of any applicable laws or regulations, or for any unintended or unauthorized application, customers and users will (a) be solely responsible for any damages, losses or penalties arising in connection therewith or as a result thereof, and (b) indemnify and hold Diodes and its representatives and agents harmless against any and all claims, damages, expenses, and attorney fees arising out of, directly or indirectly, any claim relating to any noncompliance with the applicable laws and regulations, as well as any unintended or unauthorized application.
7. While efforts have been made to ensure the information contained in this document is accurate, complete and current, it may contain technical inaccuracies, omissions and typographical errors. Diodes does not warrant that information contained in this document is error-free and Diodes is under no obligation to update or otherwise correct this information. Notwithstanding the foregoing, Diodes reserves the right to make modifications, enhancements, improvements, corrections or other changes without further notice to this document and any product described herein. This document is written in English but may be translated into multiple languages for reference. Only the English version of this document is the final and determinative format released by Diodes.
8. Any unauthorized copying, modification, distribution, transmission, display or other use of this document (or any portion hereof) is prohibited. Diodes assumes no responsibility for any losses incurred by the customers or users or any third parties arising from any such unauthorized use.

Copyright © 2021 Diodes Incorporated

www.diodes.com