

40 A, 600 V, very fast IGBT with Ultrafast diode

Features

- High current capability
- High frequency operation up to 50 KHz
- Very soft ultra fast recovery antiparallel diode

Applications

- High frequency inverters, UPS
- Motor drive
- SMPS and PFC in both hard switch and resonant topologies

Description

This device utilizes the advanced Power MESH™ process resulting in an excellent trade-off between switching performance and low on-state behavior.

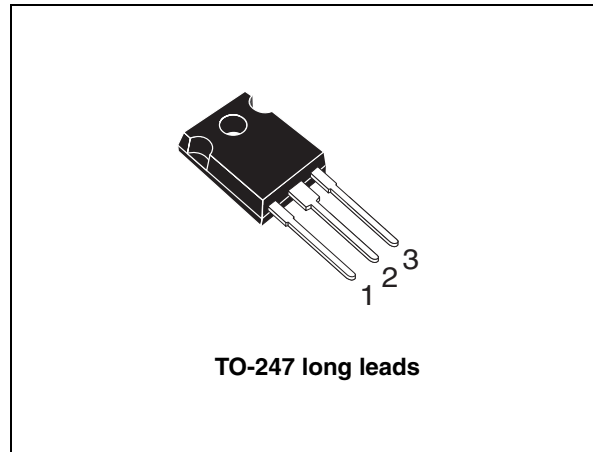

Figure 1. Internal schematic diagram

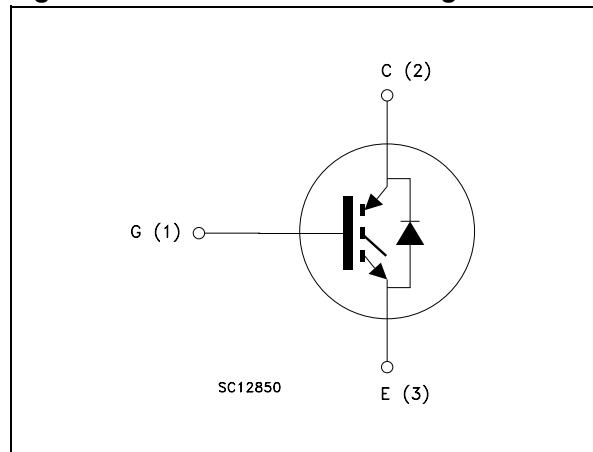

Table 1. Device summary

Order code	Marking	Package	Packaging
STGW30NC60VD	GW30NC60VD	TO-247 long leads	Tube

Contents

1	Electrical ratings	3
2	Electrical characteristics	4
2.1	Electrical characteristics (curves)	6
3	Test circuits	9
4	Package mechanical data	10
5	Revision history	12

1 Electrical ratings

Table 2. Absolute maximum ratings

Symbol	Parameter	Value	Unit
V_{CES}	Collector-emitter voltage ($V_{GE} = 0$)	600	V
$I_C^{(1)}$	Continuous collector current at $T_C = 25\text{ °C}$	80	A
$I_C^{(1)}$	Continuous collector current at $T_C = 100\text{ °C}$	40	A
$I_{CP}^{(2)}$	Pulsed collector current	150	A
$I_{CL}^{(3)}$	Turn-off latching current	100	A
V_{GE}	Gate-emitter voltage	± 20	V
I_F	Diode RMS forward current at $T_C = 25\text{ °C}$	30	A
I_{FSM}	Surge not repetitive forward current $t_p = 10\text{ ms}$ sinusoidal	120	A
P_{TOT}	Total dissipation at $T_C = 25\text{ °C}$	250	W
T_J	Operating junction temperature	- 55 to 150	°C
T_{STG}	Storage temperature		
T_L	Maximum lead temperature for soldering purpose for 10 sec	300	°C

1. Calculated according to the iterative formula:

$$I_C(T_C) = \frac{T_{j(max)} - T_C}{R_{thj-c} \times V_{CE(sat)(max)}(T_{j(max)}, I_C(T_C))}$$

2. Pulse width limited by maximum junction temperature and turn-off within RBSOA
 3. $V_{clamp} = 80\% V_{CES}$, $T_J = 150\text{ °C}$, $R_G = 10\ \Omega$, $V_{GE} = 15\text{ V}$

Table 3. Thermal data

Symbol	Parameter	Value	Unit
R_{thJC}	Thermal resistance junction-case IGBT	0.5	°C/W
	Thermal resistance junction-case diode	1.5	°C/W
R_{thJA}	Thermal resistance junction-ambient	50	°C/W

2 Electrical characteristics

$T_J = 25\text{ °C}$ unless otherwise specified.

Table 4. Static

Symbol	Parameter	Test conditions	Min.	Typ.	Max.	Unit
$V_{(BR)CES}$	Collector-emitter breakdown voltage ($V_{GE} = 0$)	$I_C = 1\text{ mA}$	600			V
$V_{CE(sat)}$	Collector-emitter saturation voltage	$V_{GE} = 15\text{ V}, I_C = 20\text{ A}$ $V_{GE} = 15\text{ V}, I_C = 40\text{ A}$ $V_{GE} = 15\text{ V}, I_C = 80\text{ A}, T_J = 100\text{ °C}$ $V_{GE} = 15\text{ V}, I_C = 20\text{ A}, T_J = 125\text{ °C}$		1.8 2.1 2.9 1.7	2.5	V
$V_{GE(th)}$	Gate threshold voltage	$V_{CE} = V_{GE}, I_C = 250\text{ }\mu\text{A}$	3.75		5.75	V
I_{CES}	Collector-cut-off current ($V_{GE} = 0$)	$V_{CE} = 600\text{ V}$ $V_{CE} = 600\text{ V}, T_J = 125\text{ °C}$			10 1	μA mA
I_{GES}	Gate-emitter leakage current ($V_{CE} = 0$)	$V_{GE} = \pm 20\text{ V}$			± 100	nA
g_{fs}	Forward transconductance	$V_{CE} = 15\text{ V}, I_C = 20\text{ A}$		15		S

Table 5. Dynamic

Symbol	Parameter	Test conditions	Min.	Typ.	Max.	Unit
C_{ies} C_{oes} C_{res}	Input capacitance Output capacitance Reverse transfer capacitance	$V_{CE} = 25\text{ V}, f = 1\text{ MHz}, V_{GE} = 0$	-	2200 225 50	-	pF pF pF
Q_g Q_{ge} Q_{gc}	Total gate charge Gate-emitter charge Gate-collector charge	$V_{CE} = 390\text{ V}, I_C = 20\text{ A},$ $V_{GE} = 15\text{ V},$ (see Figure 18)	-	100 16 45	140	nC nC nC

Table 6. Switching on/off (inductive load)

Symbol	Parameter	Test conditions	Min.	Typ.	Max.	Unit
$t_{d(on)}$ t_r $(di/dt)_{onf}$	Turn-on delay time Current rise time Turn-on current slope	$V_{CC} = 390\text{ V}, I_C = 20\text{ A},$ $R_G = 3.3\text{ }\Omega, V_{GE} = 15\text{ V}$ (see Figure 17)	-	31 11 1600	-	ns ns A/ μs
$t_{d(on)}$ t_r $(di/dt)_{on}$	Turn-on delay time Current rise time Turn-on current slope	$V_{CC} = 390\text{ V}, I_C = 20\text{ A},$ $R_G = 3.3\text{ }\Omega, V_{GE} = 15\text{ V}$ $T_J = 125\text{ °C}$ (see Figure 17)	-	31 11.5 1500	-	ns ns A/ μs

Table 6. Switching on/off (inductive load)

$t_{r(Voff)}$	Off voltage rise time	$V_{CC}=390\text{ V}, I_C=20\text{ A},$	-	28	-	ns
$t_{d(off)}$	Turn-off delay time	$R_G=3.3\ \Omega, V_{GE}=15\text{ V}$	-	100	-	ns
t_f	Current fall time	(see Figure 17)	-	75	-	ns
$t_{r(Voff)}$	Off voltage rise time	$V_{CC}=390\text{ V}, I_C=20\text{ A},$	-	66	-	ns
$t_{d(off)}$	Turn-off delay time	$R_G=3.3\ \Omega, V_{GE}=15\text{ V}$	-	150	-	ns
t_f	Current fall time	$T_j=125^\circ\text{C}$ (see Figure 17)	-	130	-	ns

Table 7. Switching energy (inductive load)

Symbol	Parameter	Test conditions	Min.	Typ.	Max.	Unit
$E_{on}^{(1)}$	Turn-on switching losses	$V_{CC}=390\text{ V}, I_C=20\text{ A},$	-	220	300	μJ
E_{off}	Turn-off switching losses	$R_G=3.3\ \Omega, V_{GE}=15\text{ V},$	-	330	450	μJ
E_{ts}	Total switching losses	(see Figure 19)	-	550	750	μJ
$E_{on}^{(1)}$	Turn-on switching losses	$V_{CC}=390\text{ V}, I_C=20\text{ A},$	-	450	-	μJ
E_{off}	Turn-off switching losses	$R_G=3.3\ \Omega, V_{GE}=15\text{ V},$	-	770	-	μJ
E_{ts}	Total switching losses	$T_j=125^\circ\text{C}$ (see Figure 19)	-	1220	-	μJ

1. E_{on} is the turn-on losses when a typical diode is used in the test circuit in Figure 19. E_{on} include diode recovery energy. If the IGBT is offered in a package with a co-pack diode, the co-pack diode is used as external diode. IGBTs & Diode are at the same temperature (25°C and 125°C)

Table 8. Collector-emitter diode

Symbol	Parameter	Test conditions	Min.	Typ.	Max.	Unit
V_F	Forward on-voltage	$I_F=20\text{ A}$ $I_F=20\text{ A}, T_j=125^\circ\text{C}$	-	1.8 1.4	2.3	V V
t_{rr}	Reverse recovery time	$I_F=20\text{ A}, V_R=40\text{ V},$	-	44	-	ns
Q_{rr}	Reverse recovery charge	$T_j=25^\circ\text{C}, di/dt=100\text{ A}/\mu\text{s}$	-	66	-	nC
I_{rrm}	Reverse recovery current	(see Figure 20)	-	3	-	A
t_{rr}	Reverse recovery time	$I_F=20\text{ A}, V_R=40\text{ V},$	-	88	-	ns
Q_{rr}	Reverse recovery charge	$T_j=125^\circ\text{C},$	-	237	-	nC
I_{rrm}	Reverse recovery current	$di/dt=100\text{ A}/\mu\text{s}$ (see Figure 20)	-	5.4	-	A

2.1 Electrical characteristics (curves)

Figure 2. Output characteristics

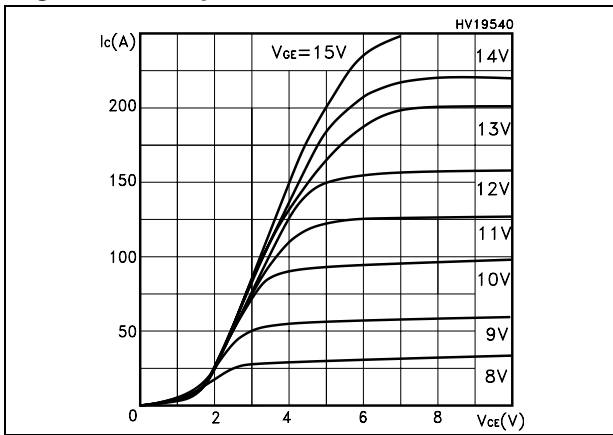

Figure 3. Transfer characteristics

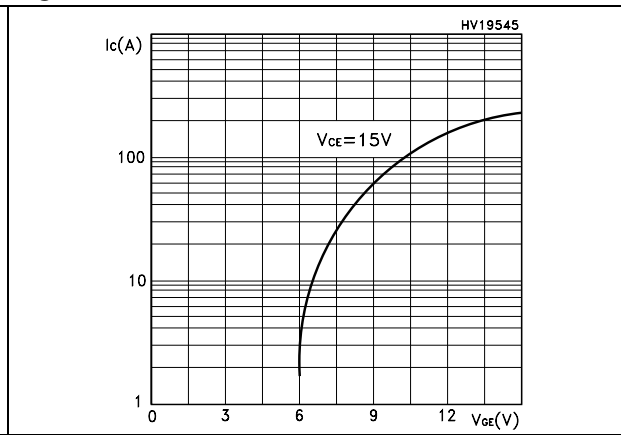

Figure 4. Trans conductance

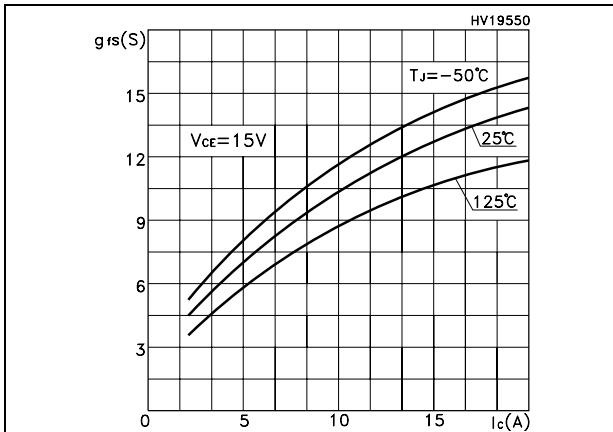

Figure 5. Collector-emitter on voltage vs temperature

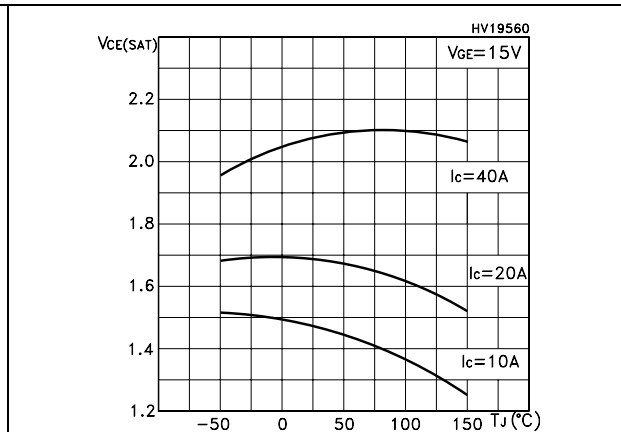

Figure 6. Collector-emitter on voltage vs collector current

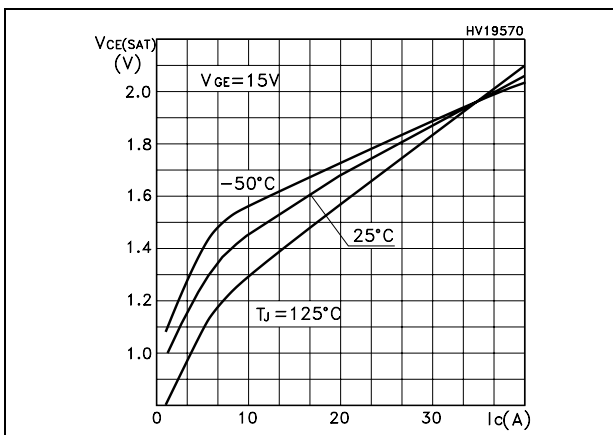

Figure 7. Normalized gate threshold vs temperature

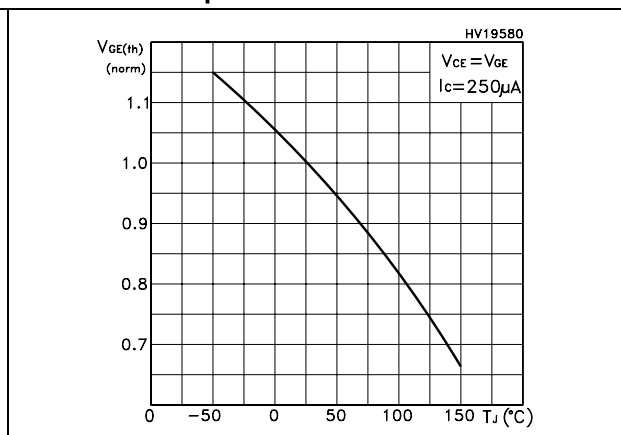

Figure 8. Normalized breakdown voltage vs temperature

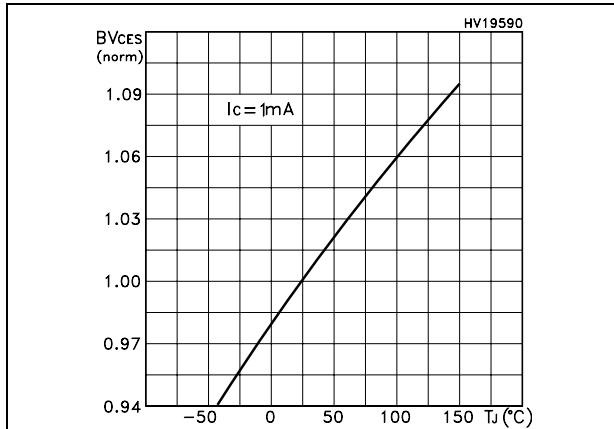

Figure 9. Gate charge vs. gate-emitter voltage

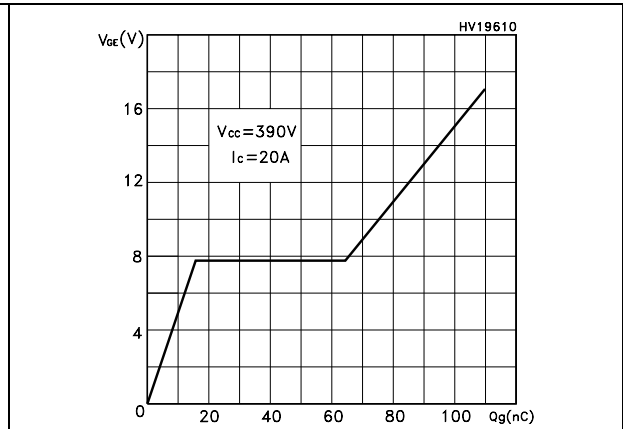

Figure 10. Capacitance variations

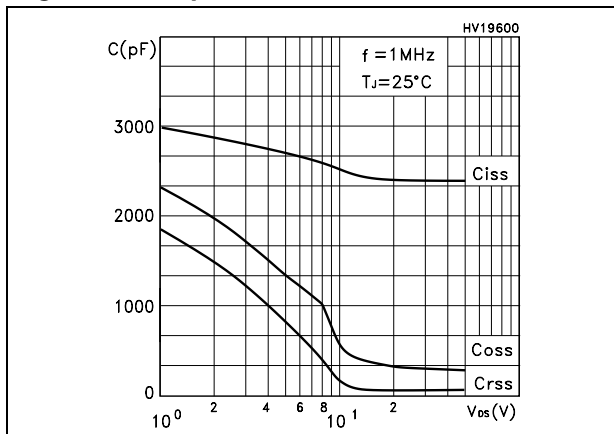

Figure 11. Switching losses vs temperature

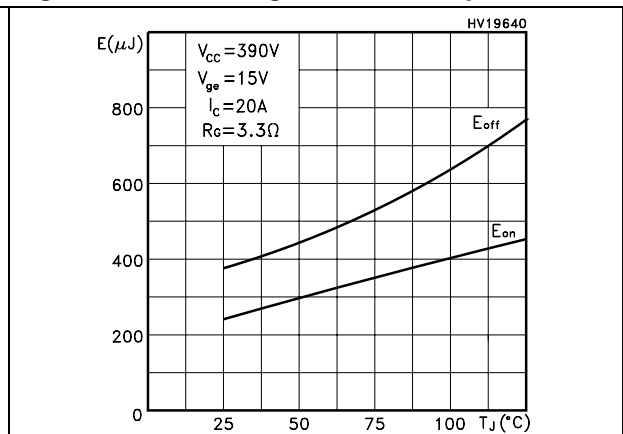

Figure 12. Switching losses vs. gate resistance

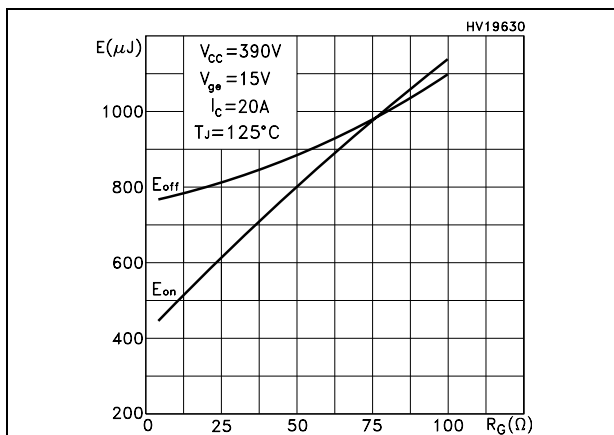

Figure 13. Switching losses vs collector current

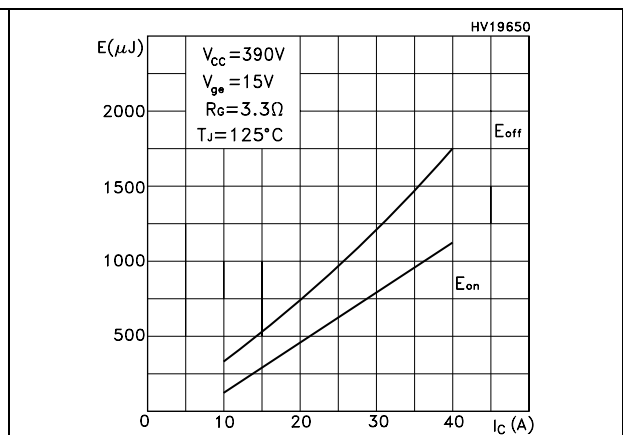

Figure 14. Thermal impedance

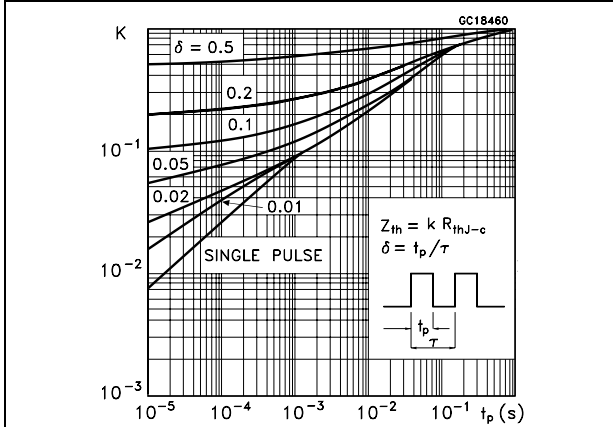

Figure 15. Turn-off SOA

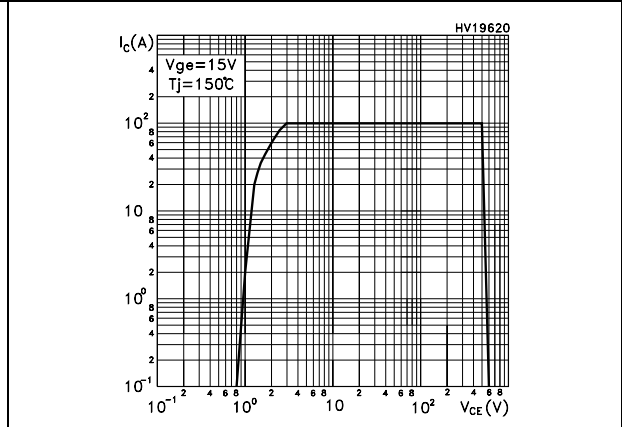
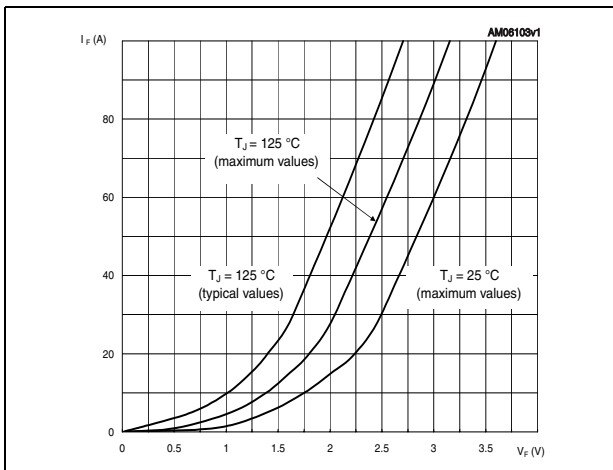

Figure 16. Emitter-collector diode characteristics



4 Package mechanical data

In order to meet environmental requirements, ST offers these devices in different grades of ECOPACK® packages, depending on their level of environmental compliance. ECOPACK® specifications, grade definitions and product status are available at: www.st.com. ECOPACK® is an ST trademark.

Table 9. TO-247 long leads mechanical data

Dim.	mm.		
	Min.	Typ.	Max.
A	4.90		5.15
D	1.85		2.10
E	0.55		0.67
F	1.07		1.32
F1	1.90		2.38
F2	2.87		3.38
G	10.90 BSC		
H	15.77		16.02
L	20.82		21.07
L1	4.16		4.47
L2	5.49		5.74
L3	20.05		20.30
L4	3.68		3.93
L5	6.04		6.29
M	2.27		2.52
V		10°	
V1		3°	
V3		20°	
Dia.	3.55		3.66

Figure 21. TO-247 long leads drawing

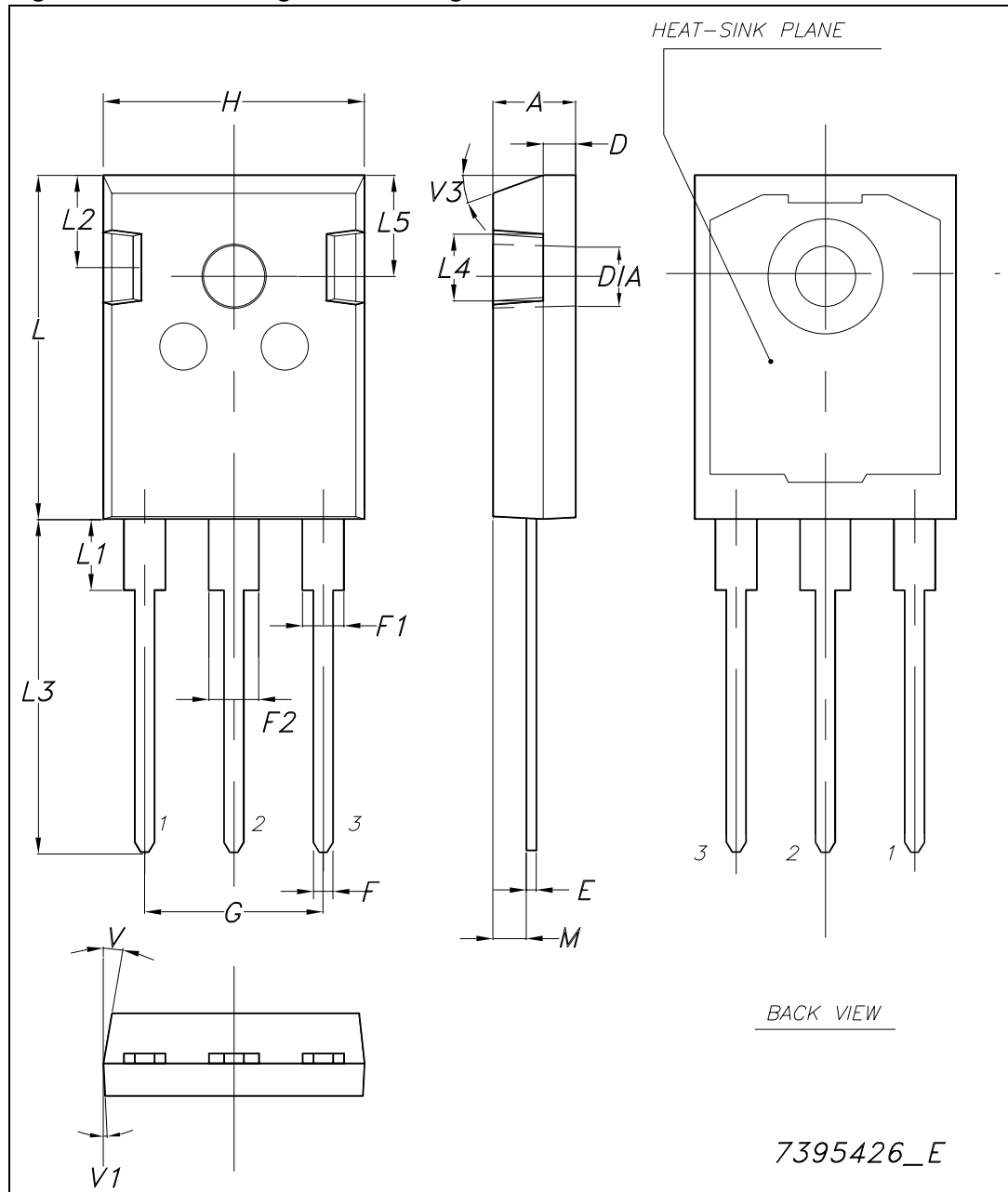

5 Revision history

Table 10. Document revision history

Date	Revision	Changes
12-Feb-2007	1	First release.
19-Feb-2007	2	<i>Figure 6</i> has been updated
12-Mar-2010	3	Inserted I_{FSM} parameter on <i>Table 2: Absolute maximum ratings</i> . Updated <i>Figure 16: Emitter-collector diode characteristics</i> and package mechanical data.
03-Jan-2011	4	Updated <i>Table 4: Static</i> , <i>Table 8: Collector-emitter diode</i> and <i>Figure 14: Thermal impedance</i> .
23-Feb-2011	5	Added T_L row <i>Table 2 on page 3</i> .

Please Read Carefully:

Information in this document is provided solely in connection with ST products. STMicroelectronics NV and its subsidiaries ("ST") reserve the right to make changes, corrections, modifications or improvements, to this document, and the products and services described herein at any time, without notice.

All ST products are sold pursuant to ST's terms and conditions of sale.

Purchasers are solely responsible for the choice, selection and use of the ST products and services described herein, and ST assumes no liability whatsoever relating to the choice, selection or use of the ST products and services described herein.

No license, express or implied, by estoppel or otherwise, to any intellectual property rights is granted under this document. If any part of this document refers to any third party products or services it shall not be deemed a license grant by ST for the use of such third party products or services, or any intellectual property contained therein or considered as a warranty covering the use in any manner whatsoever of such third party products or services or any intellectual property contained therein.

UNLESS OTHERWISE SET FORTH IN ST'S TERMS AND CONDITIONS OF SALE ST DISCLAIMS ANY EXPRESS OR IMPLIED WARRANTY WITH RESPECT TO THE USE AND/OR SALE OF ST PRODUCTS INCLUDING WITHOUT LIMITATION IMPLIED WARRANTIES OF MERCHANTABILITY, FITNESS FOR A PARTICULAR PURPOSE (AND THEIR EQUIVALENTS UNDER THE LAWS OF ANY JURISDICTION), OR INFRINGEMENT OF ANY PATENT, COPYRIGHT OR OTHER INTELLECTUAL PROPERTY RIGHT.

UNLESS EXPRESSLY APPROVED IN WRITING BY AN AUTHORIZED ST REPRESENTATIVE, ST PRODUCTS ARE NOT RECOMMENDED, AUTHORIZED OR WARRANTED FOR USE IN MILITARY, AIR CRAFT, SPACE, LIFE SAVING, OR LIFE SUSTAINING APPLICATIONS, NOR IN PRODUCTS OR SYSTEMS WHERE FAILURE OR MALFUNCTION MAY RESULT IN PERSONAL INJURY, DEATH, OR SEVERE PROPERTY OR ENVIRONMENTAL DAMAGE. ST PRODUCTS WHICH ARE NOT SPECIFIED AS "AUTOMOTIVE GRADE" MAY ONLY BE USED IN AUTOMOTIVE APPLICATIONS AT USER'S OWN RISK.

Resale of ST products with provisions different from the statements and/or technical features set forth in this document shall immediately void any warranty granted by ST for the ST product or service described herein and shall not create or extend in any manner whatsoever, any liability of ST.

ST and the ST logo are trademarks or registered trademarks of ST in various countries.

Information in this document supersedes and replaces all information previously supplied.

The ST logo is a registered trademark of STMicroelectronics. All other names are the property of their respective owners.

© 2011 STMicroelectronics - All rights reserved

STMicroelectronics group of companies

Australia - Belgium - Brazil - Canada - China - Czech Republic - Finland - France - Germany - Hong Kong - India - Israel - Italy - Japan - Malaysia - Malta - Morocco - Philippines - Singapore - Spain - Sweden - Switzerland - United Kingdom - United States of America

www.st.com