

## Multi-point Temperature Controller

## E5ZE-8□D1□B-V2

### Controls Up to Eight Zones, Built-in DeviceNet Communications

- Applications include plastic injection and extrusion machines, and continuous temperature control processes
- DeviceNet allows the controller to communicate with a remote I/O master without programming, or communicate directly with an Omron PLC via explicit messaging
- Fast sampling rate of 0.2 s for 8 inputs
- Optional 1/4 DIN size Display Unit shows temperature and settings for each zone without using software
- 3-year warranty



## Ordering Information

### ■ TEMPERATURE CONTROLLERS

Control points	Control method	Control output	Heater open circuit/SSR fault detection	Part number	
				Thermocouple	Platinum resistance thermometer
8	Heat (See Note 1)	Voltage	Yes (See Note 2)	<b>E5ZE-8AQHD1TCB-V2</b>	<b>E5ZE-8AQHD1PB-V2</b>
			No	<b>E5ZE-8AQAD1TCB-V2</b>	<b>E5ZE-8AQAD1PB-V2</b>
		Current		<b>E5ZE-8ACAD1TCB-V2</b>	<b>E5ZE-8ACAD1PB-V2</b>
	Heat and cool	Voltage	Yes (See Note 2)	<b>E5ZE-8VQHD1TCB-V2</b>	<b>E5ZE-8VQHD1PB-V2</b>
			No	<b>E5ZE-8VQAD1TCB-V2</b>	<b>E5ZE-8VQAD1PB-V2</b>
		Current		<b>E5ZE-8VCAD1TCB-V2</b>	<b>E5ZE-8VCAD1PB-V2</b>

- Note: 1. The output operation can be switched to provide cooling control.  
 2. Models are available without the Heater open circuit/SSR fault detection functions.  
 3. Number of connectable units will be limited according to remote I/O points at host system.

### ■ ACCESSORIES (ORDER SEPARATELY)

Description	Specifications	Part number
Display unit shows settings, allows programming without software; 1/4 DIN size	RS-232C connection; 100 to 240 VAC, 50/60 Hz supply voltage	<b>E5ZD-SDL1 AC100-240</b>
	RS-232C connection; 24 VDC supply voltage	<b>E5ZD-SDL1 DC24</b>
	1.5 m length cable from E5ZE to Display Unit, RS-232C with 25-pin connector	<b>ES100-CT022-202</b>
	1.5 m length cable from E5ZE to Display Unit, RS-232C with 9-pin connector	<b>ES100-CT023-202</b>
Current transformer; order only if using heater burnout alarm function	50 A load, 5.8 mm hole dia.	<b>E54-CT1</b>
	120 A load, 12 mm hole dia.	<b>E54-CT3</b>
Software	For setup and monitoring	<b>SYS-CONFIG V2.0</b>
I/O cable to E5ZE	2 m length cable connects XW2B-20G4 or XW2B-20G5 screw terminals for control and current transformer inputs and alarm outputs; order 3 cables	<b>E5ZE-CBL200</b>
DeviceNet connectors	Color-coded terminals assure correct wiring; plugs into DeviceNet port; order 2	<b>XW4B-05C1-H1-D</b>
	One-branch, T-branch tap with three connectors	<b>DCN1-1C</b>
	Three-branch, T-branch tap with five connectors	<b>DCN1-3C</b>
	Terminal block with terminating resistor: 121 Ω	<b>DRS1-T</b>

# Specifications

## ■ TEMPERATURE CONTROLLER

### Ratings

Rated voltage		24 VDC
Permissible voltage fluctuation		85 to 110% of rated voltage
Power consumption		15 W +20% max. at 24 VDC
Sensor inputs	Inputs	Thermocouple: K, J, T, E, L, U, N, R, S, B, W, and PL II Platinum resistance thermometer: JPt 100, Pt 100
	Input impedance	Thermocouple: 1 MΩ min.
	Rated current	Platinum resistance thermometer: 1 mA
Control outputs	Voltage output (with short-circuit protection)	ON voltage: 12 ±1.2 VDC OFF voltage: 0.5 VDC max. Max. load current: 30 mA/output
	Current output	Rated output range: 4 to 20 mA (4 +0/-0.6 mA for 0% output, 20 +2/-0 mA for 100% output) Max. load resistance: 600 Ω/output
	Open-collector NPN output (cooling only)	Max. voltage: 30 VDC Max. load current: 50 mA/output Residual voltage when ON: 2 VDC max. Leakage current when OFF: 1 mA max.
Alarm outputs		Temperature alarms: Two outputs: alarm 1 and alarm 2 for all outputs in each word. HB alarm (heater burnout detection): One output for all outputs in each word. HS alarm (SSR fault detection): One output for all outputs in each word. Temperature controller error output (memory, set value, or hardware error): One output All outputs are NPN open-collector outputs with a max. voltage of 30 VDC and max. load current of 50 mA/output.
Number of inputs		8 input points and 8 control points
Setting method		Set by communications
Control method		ON/OFF, hybrid of advanced PID and fuzzy logic control, or manual operation
Memory bank input		8 points for each control point Designated through communication or memory bank designation input
Memory bank designation inputs		With contact signal input: ON short-circuit resistance: 1 kΩ max. OFF open resistance: 100 kΩ min. With non-contact signal input: ON residual voltage: 2 VDC max. OFF leakage current: 1 mA DC max.
Ambient temperature		Operating: 0°C to 55°C (32°F to 131°F) with no icing or condensation Storage: -25°C to 65°C (-14°F to 149°F) with no icing or condensation
Ambient humidity		Operating: 35% to 85% RH

### Temperature Ranges

Input		Temperature range		Setting (See Note 1)	Minimum units
Thermocouple	K (CA)	-200°C to 1,300°C	-300°F to 2,300°F	0	1°C or 0.1°C
	J (IC)	-100°C to 850°C	-100°F to 1,500°F	1	
	R	0°C to 1,700°C	0°F to 3,000°F	2	
	S	0°C to 1,700°C	0°F to 3,000°F	3	
	T (CC)	-200°C to 400°C	-300°F to 700°F	4	
	E (CRC)	0°C to 600°C	0°F to 1,100°F	5	
	B	100°C to 1,800°C	300°F to 3,000°F	6	
	N	0°C to 1,300°C	0°F to 2,300°F	7	
	L	-100°C to 850°C	-100°F to 1,500°F	8	
	U	-200°C to 400°C	-300°F to 700°F	9	
	W	0°C to 2,300°C	32°F to 4,100°F	A	
Platinum resistance thermometer	PL II <sup>2</sup>	0°C to 1,300°C	0°F to 2,300°F	B	
	Pt100	-100.0°C to 500.0°C	-100.0°F to 900.0°F	0	
	JPt100	-100.0°C to 500.0°C	-100.0°F to 900.0°F	1	

Note: 1. The factory setting is 0 (Type K for thermocouple input or Pt100 for platinum resistance thermometer input.)

2. Platinel is a registered trademark of Englehard Industries.

## Characteristics

Measurement precision	Thermocouple: (±0.3% of the measured value or ±2°C, whichever is larger) ±1 digit max. (±0.3% of the measured value or ±3.6°F, whichever is larger) ±1 digit max. Platinum resistance thermometer: (±0.3% of the measured value or ±0.8°C, whichever is larger) ±1 digit max. (±0.3% of the measured value or ±1.5°F, whichever is larger) ±1 digit max.
Adjustable sensitivity	0.0°C to 99.9°C or 0.0°F to 99.9°F (0.1° increments), valid for ON/OFF control only.
Cooling coefficient	0.0 to 10.0 (0.1 increments)
Proportional band	0.0°C to 999.9°C or 0.0°F to 999.9°F (0.1° increments) Cooling: cooling coefficient × proportional band
Integral time	0 to 3,999 s (1-s increments)
Derivative time	0 to 3,999 s (1-s increments)
Control cycle	Heating or cooling: 1 to 99 s (1-s increments)
Sampling cycle	Approx. 200 ms/8 words
Dead band/overlap Band	-999°C to 999°C or -999°F to 999°F (1° increments)
Alarm set range	With 1° increments: -999° to 9,999° (0° to 9,999° with upper/lower limit alarms) With 0.1° increments: -999.9° to 9,999.9° (0.0° to 9,999.9° with upper/lower limit alarms)
Fuzzy logic strength	0 to 99% (1% increments)
Fuzzy logic scale 1	0.2° to 999.9° (0.1° increments)
Fuzzy logic scale 2	0.02° to 99.99° (0.01° increments)
SV protection	Lithium battery backup
SV protection time	10 years min. at room temperature
Insulation resistance	20 MΩ at 500 VDC between the FG terminal and analog input terminals
Dielectric strength	Leakage current of 1 mA max. between the FG terminal and analog input terminals when 500 VAC is applied for 1 min.
Vibration resistance	Malfunction: 10 to 55 Hz with 15 m/s <sup>2</sup> in X, Y, and Z directions for 8 min. Destruction: 10 to 55 Hz with 20 m/s <sup>2</sup> in X, Y, and Z directions for 8 min.
Shock resistance	Malfunction: 150 m/s <sup>2</sup> max. 3 times each in ±X, ±Y, and ±Z directions Destruction: 200 m/s <sup>2</sup> max. 3 times each in ±X, ±Y, and ±Z directions
Degree of protection	IP00
Weight	Case-type Unit: 1,700 g max.

Note: 1. The measurement accuracy of the E5ZE used with a thermocouple B at 400°C or 750°F max. is not guaranteed. The following measurement accuracy values are applied to the E5ZE.

K and T at -100°C max. and U: ±3°C ±1 digit max.

K and T at -100°F max. and U: ±5.4°F ±1 digit max.

R, S, and W at 200°C max., and B at 1,000°C max.: ±4°C ±1 digit max.

R, S, and W at 400°F max., and B at 1,800°F max.: ±7.2°F ±1 digit max.

2. The measurement accuracy of the E5ZE used with any thermocouple is 1°C/°F. The thermocouple can be used under the following temperature ranges to increase the measurement accuracy to as high as 0.1°C/°F.

K thermocouple: 0.0 °C to 1,300.0 °C, 0.0 °F to 2,300.0 °F

T or U thermocouple: 0.0 °C to 400.0 °C, 0.0 °F to 700.0 °F

N thermocouple: 400.0 °C to 1,300.0 °C, 700.0 °F to 2,300.0 °F

J, E, L, or PLII thermocouple: Any temperature

3. Upper limit is 3000.0°C/°F when set from CompoBus/D.

## ■ DISPLAY UNIT

### Ratings

Supply voltage	100 to 240 VAC, 50/60 Hz or 24 VDC
Operating voltage range	85% to 110% of rated supply voltage
Power consumption	Approx. 8 VA at 100 VAC to 12 VA at 420 VAC; approx. 5 W at 24 VDC
Setting method	Digital setting via Up and Down keys
Display method	LED character heights: PV: 15 mm (red); SV: 11 mm (green); UNIT/CH/BK: 11 mm (orange)
Other functions	Key protection Display group selection Display scan function

**Characteristics**

Sampling period	500 ms, 1 s (selectable)
Enclosure ratings	Front panel: IP50 Rear case: IP20 Terminals: IP00
Vibration resistance	Malfunction: 2 to 55 Hz, 19.6 m/s <sup>2</sup> for 10 min each in X, y, and Z directions
Shock resistance	Malfunction: 196 m/s <sup>2</sup> for 3 times in each of 6 directions
Ambient temperature	-10°C to 55°C (4°F to 131°F) with no icing
Ambient humidity	35% to 85% RH
Weight	Approx. 450 g

**■ COMMUNICATIONS****Conforming to DeviceNet Communications Protocol**

For details, refer to the *E5ZE-8 Multi-point Temperature Controller Communications Manual (H114)*.

Connection method	Multi-drop or T-branching (See Note 1)			
Baud rate	500/250/125 kbps			
Communications media	Dedicated 5-wire cable (with 2 communications wires, 2 power wires, and 1 shield wire) with XW4B-05C1-H1-D or equivalent connectors on each end.			
Communications distance	<u>Baud rate</u>	<u>Maximum network length (See Note 2)</u>	<u>Branch line length</u>	<u>Total branch line length</u>
	500 kbps	100 m max. (See Note 3)	6 m max.	39 m max.
	250 kbps	250 m max. (See Note 3)	6 m max.	78 m max.
	125 kbps	500 m max. (See Note 3)	6 m max.	156 m max.
Remote I/O points	IN: 14 / OUT: 9			
Error control	CRC error and node address duplication check			

Note: 1. An external terminator must be attached.

2. Indicates the distance between nodes farthest from each other.

3. The maximum network length is 100 m if a thin dedicated cable is applied to the trunk line.

**⚠ NOTICE:** This product has been tested by ODVA's authorized Independent Test Lab and found to comply with ODVA Conformance Test Software Version 2.0-1.00.

For the specifications of objects in details, refer to the *E5ZE-8 Multi-point Temperature Controller Communications Manual (H114)*.

**CompoBus/D Communications Items**

Remote I/O communications	IN: Temperature measurement (8 points), Alarms 1 and 2 status, AT status, HB alarm status, HS alarm status, and error status OUT: RUN/STOP and SP (set point) (8 points)
FINS message communications	All read and write parameters

# Nomenclature

## ■ DISPLAY UNIT

### E5ZD-SDL1

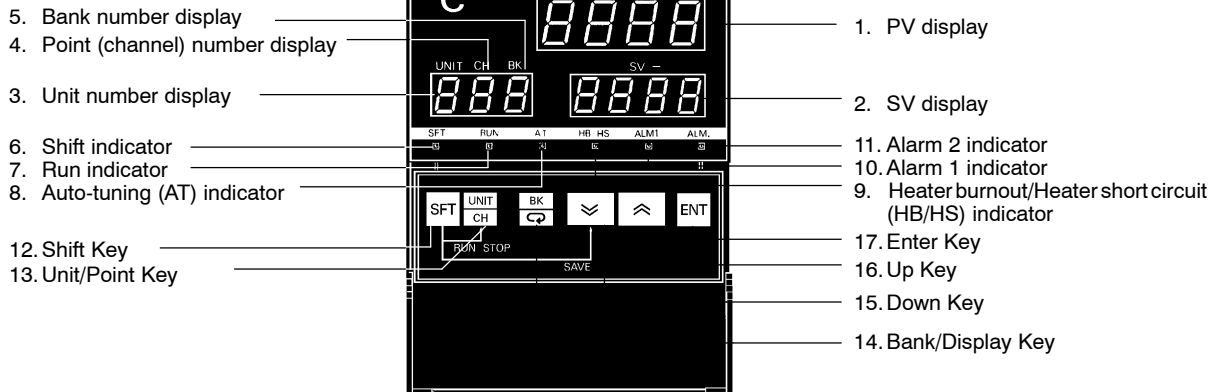

## Display

No.	Display	Meaning
1	Process Value (PV) display	The measured temperature and the set item characters are displayed according to the display mode. An error message is displayed if the system has an error. -1 is displayed for the leftmost digit of a figure between -1,000 and -1,999.
2	Set Value (SV) display	The value that has been set is displayed according to the display mode. An error message is displayed if the system has an error. -1 is displayed for the leftmost digit of a figure between -1,000 and -1,999.
3	Unit number display	The unit number that has been selected is displayed.
4	Point number display	The point number that has been selected is displayed.
5	Bank number display	The bank number that has been selected is displayed.
6	Shift indicator	Lit at the time of key shift.
7	Run indicator	Lit when the displayed unit is being controlled.
8	Auto-tuning (AT) indicator	Flashes while auto-tuning is being executed.
9	Heater burnout/Heater short circuit (HB/HS) alarm indicator	Lit when heater burnout or heater short circuit alarm output is ON.
10	Alarm 1 indicator	Lit when alarm output 1 is ON.
11	Alarm 2 indicator	Lit when alarm output 2 is ON.

Key

No.	Key	Meaning
12	Shift Key	Turns ON or OFF the shift indicator.
13	Unit/Point Key	<p>Displays the next point number while the shift display is OFF. Any invalid point is skipped.</p> <p>0 → 1 → 2 → 3 → ... → Maximum point → <i>d</i>     <i>d</i> : All points</p> <p>Displays the next unit number while the shift display is ON. <i>R</i>, <i>b</i>, <i>ℓ</i>, <i>d</i>, <i>E</i>, and <i>F</i> are displayed for the 10th unit number and the succeeding unit numbers.</p> <p>0 → 1 → 2 → 3 → ... → Maximum unit → <i>d</i>     <i>d</i> : All units</p>
14	Bank/Display Key	<p>Displays the next display mode while the shift display is OFF.</p> <p>Displays the next bank number when the shift display is lit.</p> <p>0 → 1 → 2 → 3 → 4 → 5 → 6 → 7 → <i>d</i>     <i>d</i> : All banks</p>
15	Down Key	<p>Decreases the set value within the available setting range. The set value decreases continuously if this key is pressed for 0.5 s or more.</p> <p>Note: This key does not function if the key protect switch is turned ON.</p>
16	Up Key	<p>Increases the set value within the available setting range. The set value increases continuously if this key is pressed for 0.5 s or more.</p> <p>Note: This key does not function if the key protect switch is turned ON.</p>
17	Enter Key	<p>Writes the set value to the E5ZD Setting Display Unit.</p> <p>Note: This key does not function if the key protect switch is turned ON.</p>

Operation

■ SYSTEM CONFIGURATION

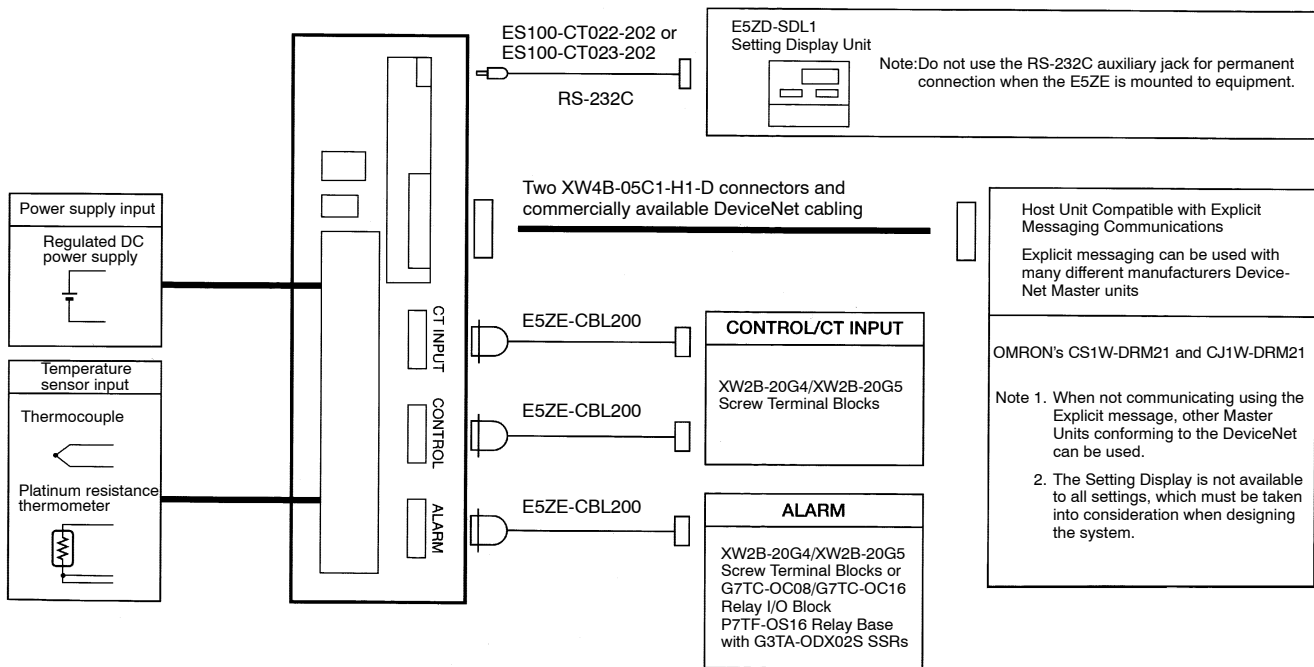

**Caution**

Be sure to use the above Units, which save wiring effort, and connection cables for the prevention of malfunctions or accidents that may be caused by mistakes in wiring.

# Dimensions

Unit: mm (inch)

## E5ZE-8□D1□B-V2

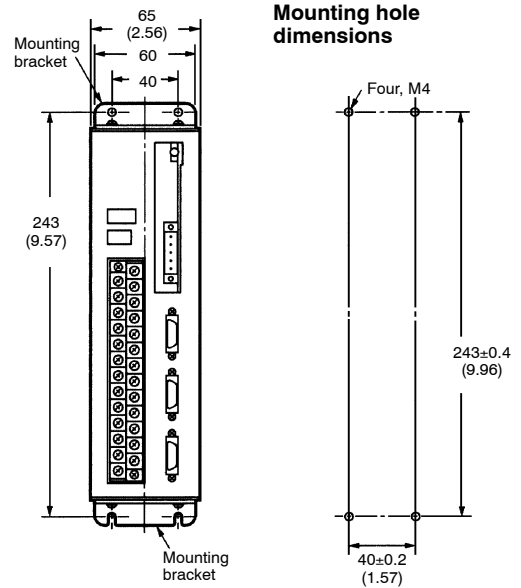
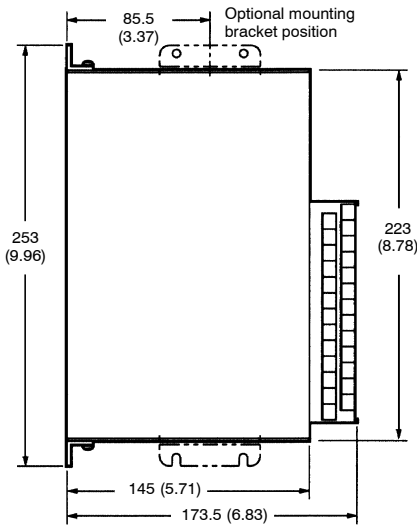
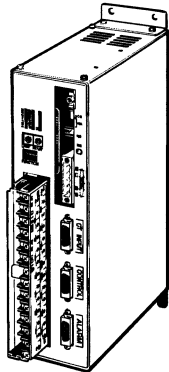

# Precautions

## ■ MOUNTING THE CONTROLLERS

### Side-by-side, Close Mounting

Saves space and improves wiring efficiency.

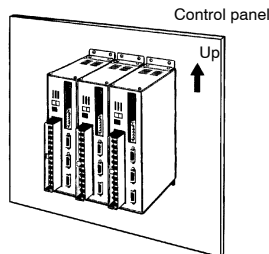

### Wall Mounting

Can be mounted to places with limited depth.

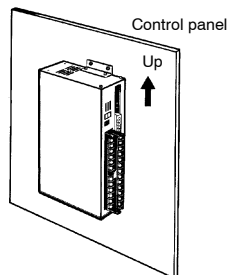

### General Mounting Precautions

The side of the E5ZE with the terminal block and connectors must not face up, otherwise operating errors may result.

Prepare four M4 screws to mount the E5ZE to control panels. Use flat washers and spring washers with screws to mount the E5ZE to control panels so that the screws will not loosen.

The mounting brackets must be attached to the E5ZE with the four M3 x 6 screws provided with the E5ZE and each of the screws should be tightened to a torque of 0.43 to 0.58 N • m, or 4.4 to 5.9 kgf • cm.

Do not mount as shown in the following diagram.

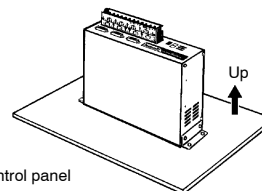

## ■ WIRING DEVICENET CONNECTORS

The following diagram shows how the DeviceNet connector XW4B-05C1-H1-D is wired. Multi-drop connections cannot be used with this connector. The connector is color-coded to match the insulating sheath of each conductor.

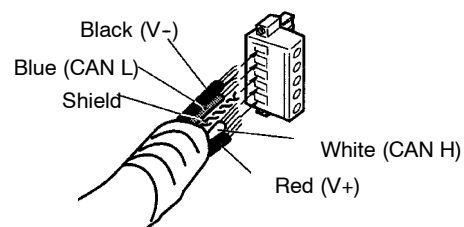

**NOTE: DIMENSIONS SHOWN ARE IN MILLIMETERS. To convert millimeters to inches divide by 25.4.**

**OMRON**<sup>®</sup>

**OMRON ELECTRONICS LLC**

One East Commerce Drive  
Schaumburg, IL 60173

**1-800-55-OMRON**

**OMRON ON-LINE**

Global - <http://www.omron.com>

USA - <http://www.omron.com/oei>

Canada - <http://www.omron.com/oci>

**OMRON CANADA, INC.**

885 Milner Avenue  
Scarborough, Ontario M1B 5V8

**416-286-6465**