



Fast Recovery Diodes (Stud Version), 6 A, 12 A, 16 A



DO-4 (DO-203AA)

FEATURES

- Short reverse recovery time
- Low stored charge
- Wide current range
- Excellent surge capabilities
- Standard JEDEC® types
- Stud cathode and stud anode versions
- Fully characterized reverse recovery conditions
- Material categorization: for definitions of compliance please see www.vishay.com/doc?99912



RoHS
COMPLIANT

TYPICAL APPLICATIONS

- DC power supplies
- Inverters
- Converters
- Choppers
- Ultrasonic systems
- Freewheeling diodes

PRIMARY CHARACTERISTICS	
$I_{F(AV)}$	6 A, 12 A, 16 A
Package	DO-4 (DO-203AA)
Circuit configuration	Single

MAJOR RATINGS AND CHARACTERISTICS					
PARAMETER	TEST CONDITIONS	6FL	12FL	16FL	UNITS
$I_{F(AV)}$		6	12	16	A
	T_C	100	100	100	°C
$I_{F(RMS)}$		9.5	19	25	A
I_{FSM}	50 Hz	110	145	180	A
	60 Hz	115	150	190	
I^2t	50 Hz	60	103	160	A ² s
	60 Hz	55	94	150	
$I^2\sqrt{t}$		1452	1452	2290	$I^2\sqrt{s}$
V_{RRM}	Range	50 to 1000	50 to 1000	50 to 1000	V
t_{rr}		See Recovery Characteristics table	See Recovery Characteristics table	See Recovery Characteristics table	ns
T_J	Range	-65 to +150	-65 to +150	-65 to +150	°C

ELECTRICAL SPECIFICATIONS

VOLTAGE RATINGS						
TYPE NUMBER	VOLTAGE CODE	V_{RRM} , MAXIMUM REPETITIVE PEAK AND OFF-STATE VOLTAGE V	V_{RSM} , MAXIMUM NON-REPETITIVE PEAK VOLTAGE V	I_{RRM} MAXIMUM AT $T_J = 25\text{ °C}$ µA	I_{RRM} MAXIMUM AT $T_J = 100\text{ °C}$ mA	I_{RRM} MAXIMUM AT $T_J = 150\text{ °C}$ mA
VS-6FL..., VS-12FL..., VS-16FL..	5	50	75	50	-	6.0
	10	100	150			
	20	200	275			
	40	400	500			
	60	600	725			
	80	800	950			
	100	1000	1250			



FORWARD CONDUCTION								
PARAMETER	SYMBOL	TEST CONDITIONS		6FL..	12FL..	16FL..	UNITS	
Maximum average forward current at case temperature	$I_{F(AV)}$	180° conduction, half sine wave DC		6	12 ⁽¹⁾	16	A	
				100	100	100	°C	
Maximum RMS current	$I_{F(RMS)}$			9.5	19	25		
Maximum peak, one-cycle non-repetitive forward current	I_{FSM}	t = 10 ms t = 8.3 ms	No voltage reappplied	Sinusoidal half wave, initial $T_J = 150\text{ °C}$	130	170	215	A
					135	180	225	
					110	145	180	
					115	150 ⁽¹⁾	190	
Maximum I^2t for fusing	I^2t	t = 10 ms t = 8.3 ms	No voltage reappplied	$T_J = 150\text{ °C}$	86	145	230	A ² s
					78	130	210	
					60	103	160	
					55	94	150	
Maximum $I^2\sqrt{t}$ for fusing	$I^2\sqrt{t}$	t = 0.1 ms to 10 ms, no voltage reappplied		856	1452	2290	A ² √s	
Maximum forward voltage drop	V_{FM}	$T_J = 25\text{ °C}; I_F = \text{Rated } I_{F(AV)} \text{ (DC)}$		1.4	1.4 ⁽¹⁾	1.4	V	
		$T_C = 100\text{ °C}; I_{FM} = \pi \times \text{rated } I_{F(AV)}$		1.5	1.5 ⁽¹⁾	1.5		

Note

(1) JEDEC® registered values

RECOVERY CHARACTERISTICS												
PARAMETER	SYMBOL	TEST CONDITIONS	6FL...			12FL...			16FL..			UNITS
			S02	S05	S10	S02	S05	S10	S02	S05	S10	
Maximum reverse recovery time	t_{rr}	$T_J = 25\text{ °C}, I_F = 1\text{ A to } V_R = 30\text{ V}, di_F/dt = 100\text{ A}/\mu\text{s}$	110	285	490	100	250	430	90	225	390	ns
		$T_J = 25\text{ °C}, di_F/dt = 25\text{ A}/\mu\text{s}, I_{FM} = \pi \times \text{rated } I_{F(AV)}$	200	500	1000	200	500	1000	200	500	1000	
Maximum peak recovery current	$I_{RM(REC)}$	$I_{FM} = \pi \times \text{rated } I_{F(AV)}$	-	-	-	-	-	-	-	-	-	
Maximum reverse recovery charge	Q_{rr}	$T_J = 25\text{ °C}, I_F = 1\text{ A to } V_R = 30\text{ V}, di_F/dt = 100\text{ A}/\mu\text{s}$	230	1700	5000	200	1300	3800	150	1100	3000	nC
		$T_J = 25\text{ °C}, di_F/dt = 25\text{ A}/\mu\text{s}, I_{FM} = \pi \times \text{rated } I_{F(AV)}$	200	1200	5000	200	1200	5000	200	1200	5000	

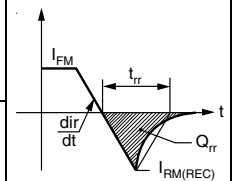

Note

(1) JEDEC® registered values

THERMAL AND MECHANICAL SPECIFICATIONS							
PARAMETER	SYMBOL	TEST CONDITIONS		6FL..	12FL..	16FL..	UNITS
Maximum junction operating temperature range	T_J			-65 to +150			°C
Maximum storage temperature range	T_{Stg}			-65 to +175			
Maximum thermal resistance, junction to case	R_{thJC}	DC operation		2.5	2.0	1.6	°C/W
Maximum thermal resistance, case to heatsink	R_{thCS}	Mounting surface, smooth, flat, and greased		0.5			
Allowable mounting torque			Not lubricated threads	1.5 + 0 - 10 % (13)			N · m (lbf · in)
			Lubricated threads	1.2 + 0 - 10 % (10)			
Approximate weight					7		g
					0.25		oz.
Case style			JEDEC®		DO-4 (DO-203AA)		

ΔR_{thJC} CONDUCTION								
CONDUCTION ANGLE	6FL..	12FL..	16FL..	6FL..	12FL..	16FL..	TEST CONDITIONS	UNITS
	SINUSOIDAL CONDUCTION			RECTANGULAR CONDUCTION				
180°	0.58	0.46	0.37	0.33	0.26	0.21	$T_J = 150\text{ }^\circ\text{C}$	K/W
120°	0.60	0.48	0.39	0.58	0.46	0.37		
60°	1.28	1.02	0.82	1.28	1.02	0.82		
30°	2.20	1.76	1.41	2.20	1.76	1.41		

Note

- The table above shows the increment of thermal resistance R_{thJC} when devices operate at different conduction angles than DC

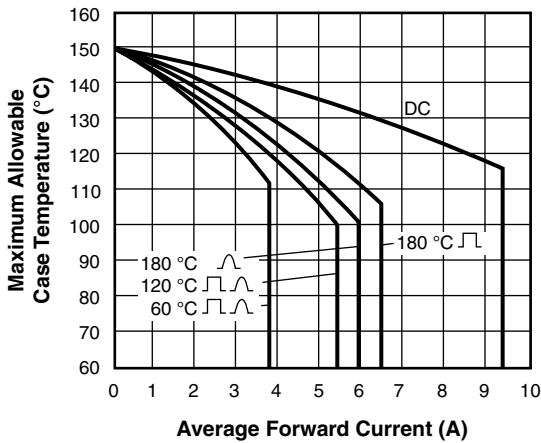

Fig. 1 - Average Forward Current vs. Maximum Allowable Case Temperature, 6FL Series

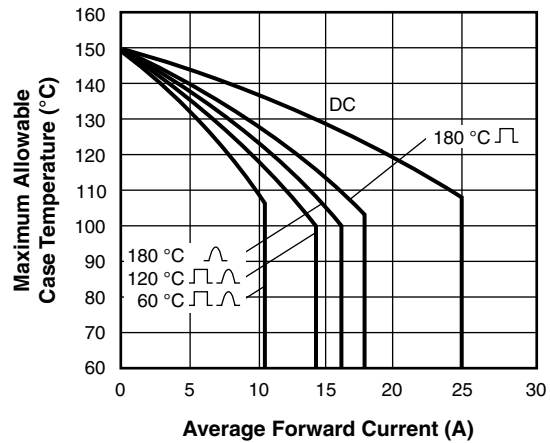

Fig. 3 - Average Forward Current vs. Maximum Allowable Case Temperature, 16FL Series

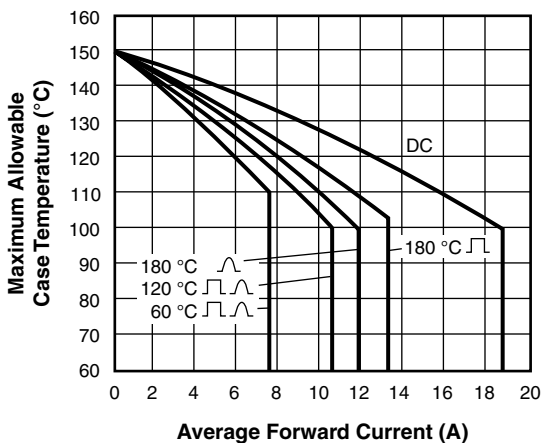
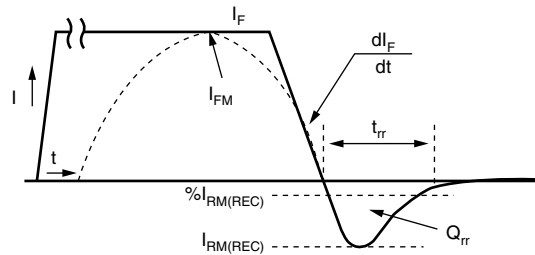
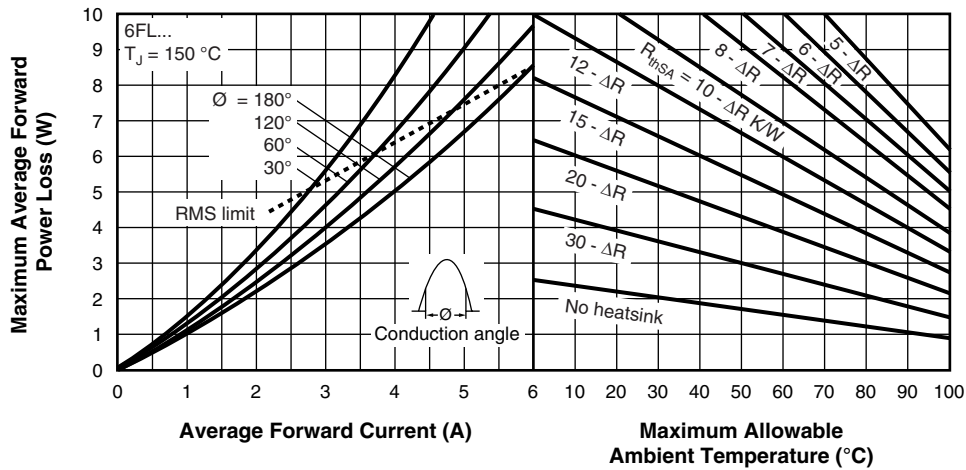

Fig. 2 - Average Forward Current vs. Maximum Allowable Case Temperature, 12FL Series



I_F, I_{FM} - Peak forward current prior to commutation
 $-dI_F/dt$ - Rate of fall of forward current
 $I_{RM(REC)}$ - Peak reverse recovery current
 t_{rr} - Reverse recovery time
 Q_{rr} - Reverse recovered charge

Fig. 4 - Reverse Recovery Time Test Waveform



Conduction angle - ϕ	ΔR - K/W
180°	0.58
120°	0.60
60°	1.28
30°	2.20

Fig. 5 - Current Rating Nomogram (Sinusoidal Waveforms), 6FL Series

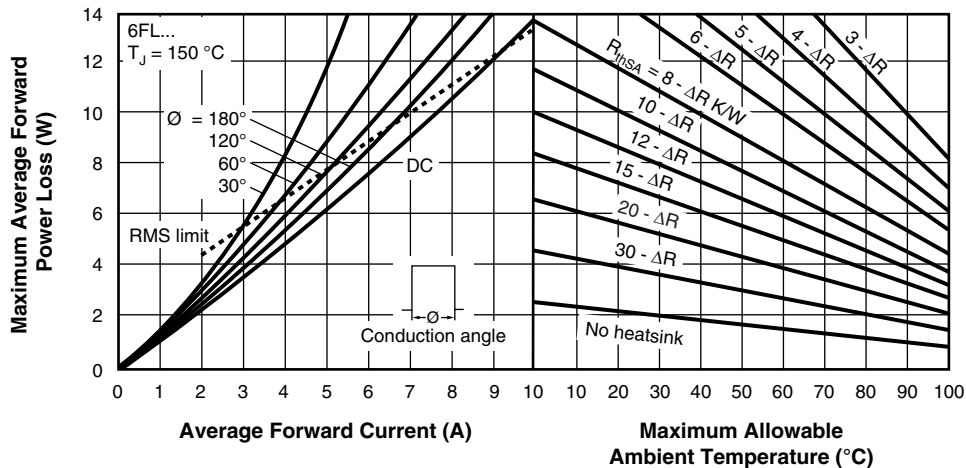

Conduction angle - ϕ	ΔR - K/W
DC	0
180°	0.33
120°	0.58
60°	1.28
30°	2.20

Fig. 6 - Current Rating Nomogram (Rectangular Waveforms), 6FL Series

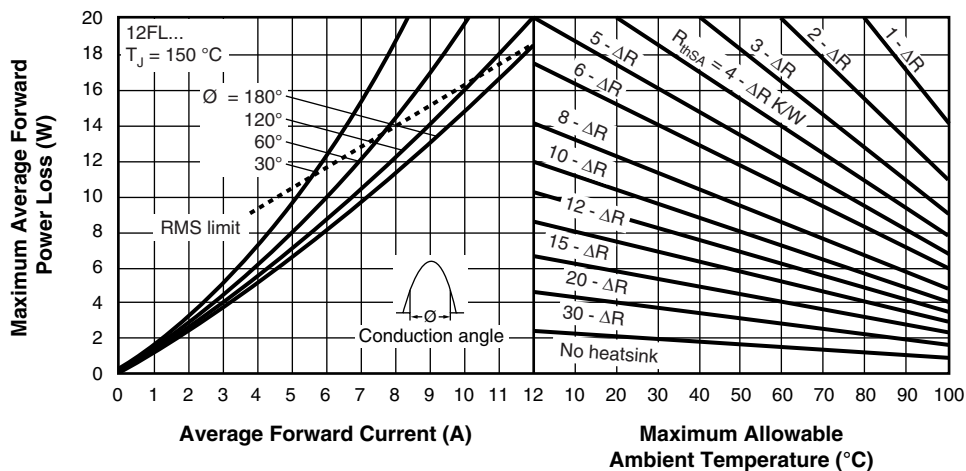

Conduction angle - ϕ	ΔR - K/W
180°	0.46
120°	0.48
60°	1.02
30°	1.76

Fig. 7 - Current Rating Nomogram (Sinusoidal Waveforms), 12FL Series

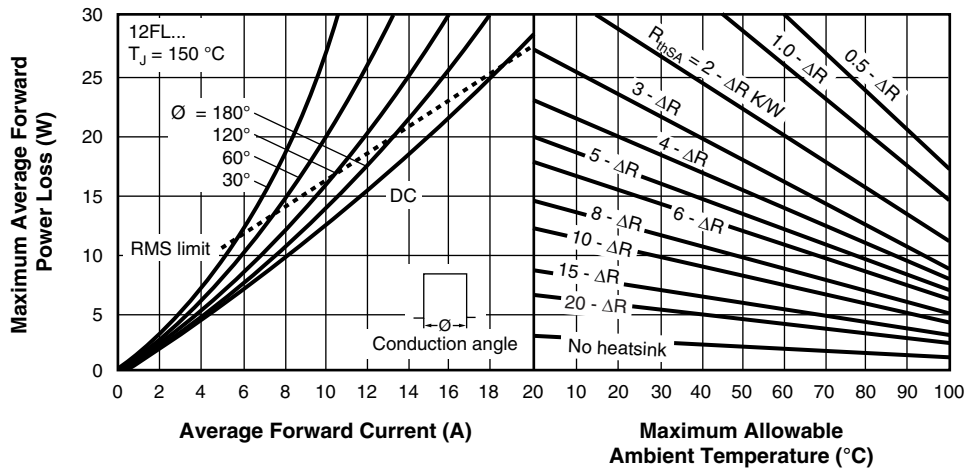

Conduction angle - ϕ	ΔR - K/W
DC	0
180°	0.26
120°	0.46
60°	1.02
30°	1.76

Fig. 8 - Current Rating Nomogram (Rectangular Waveforms), 12FL Series

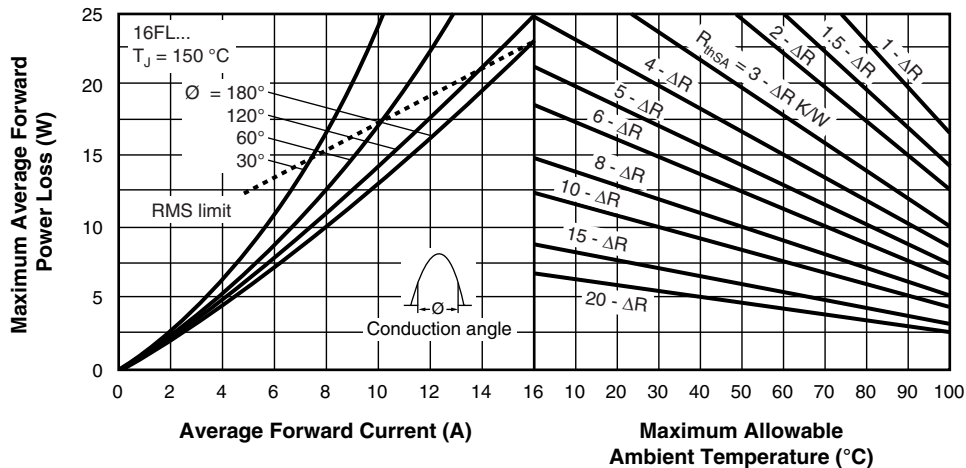

Conduction angle - ϕ	ΔR - K/W
180°	0.37
120°	0.39
60°	0.82
30°	1.41

Fig. 9 - Current Rating Nomogram (Sinusoidal Waveforms), 16FL Series

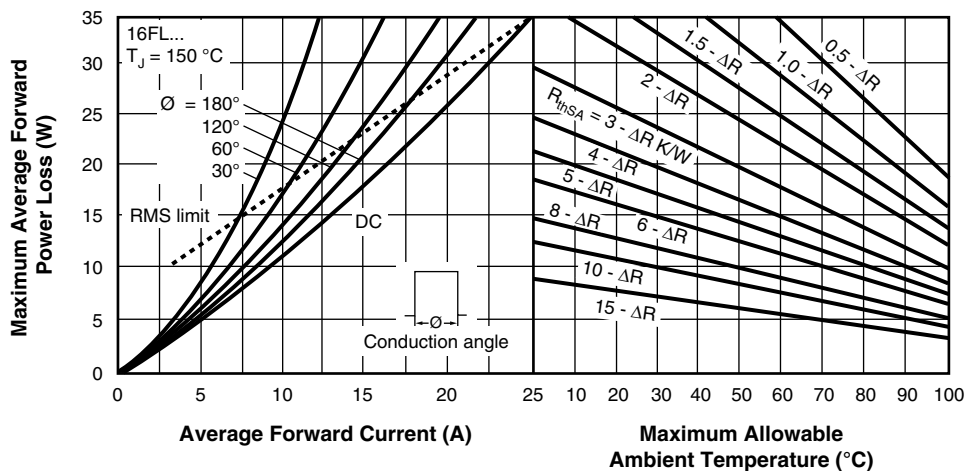

Conduction angle - ϕ	ΔR - K/W
DC	0
180°	0.21
120°	0.37
60°	0.82
30°	1.41

Fig. 10 - Current Rating Nomogram (Rectangular Waveforms), 16FL Series

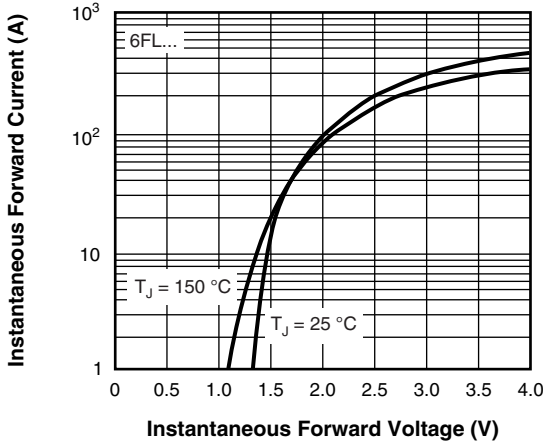

Fig. 11 - Maximum Forward Voltage vs. Forward Current, 6FL Series

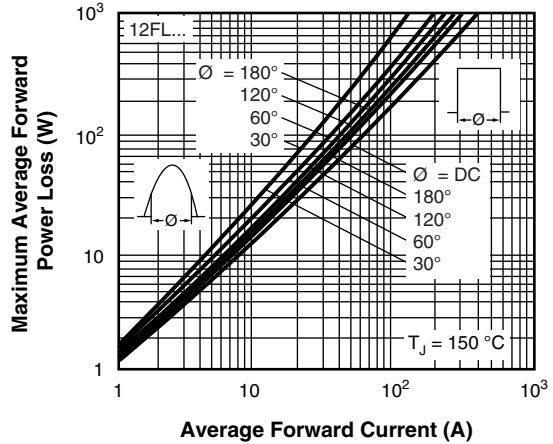

Fig. 14 - Maximum High Level Forward Power Loss vs. Average Forward Current, 12FL Series

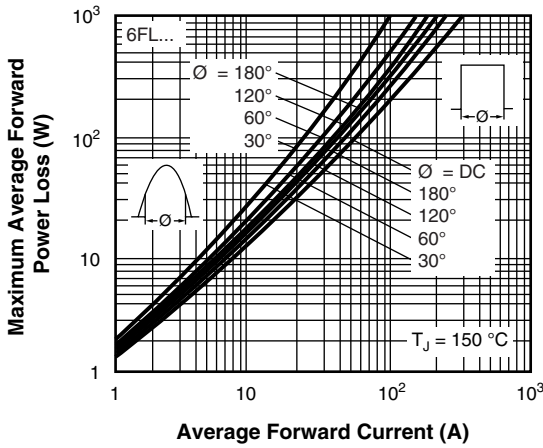

Fig. 12 - Maximum High Level Forward Power Loss vs. Average Forward Current, 6FL Series

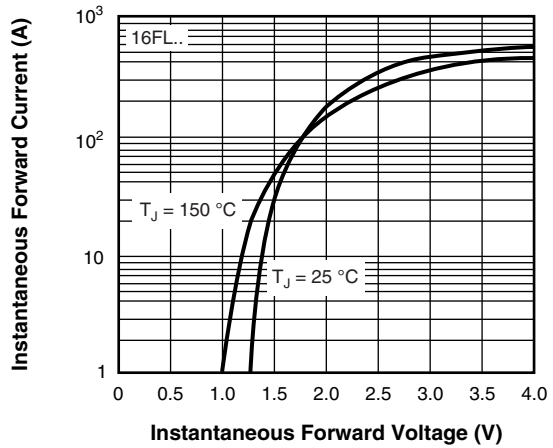

Fig. 15 - Maximum Forward Voltage vs. Forward Current, 16FL Series

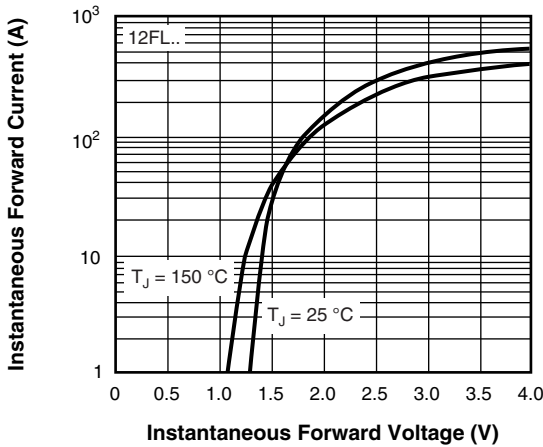

Fig. 13 - Maximum Forward Voltage vs. Forward Current, 12FL Series

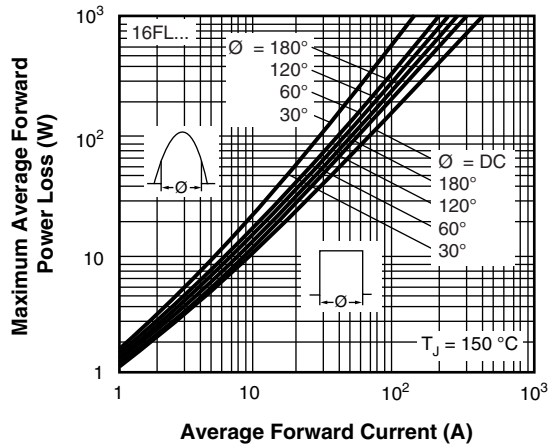

Fig. 16 - Maximum High Level Forward Power Loss vs. Average Forward Current, 16FL Series

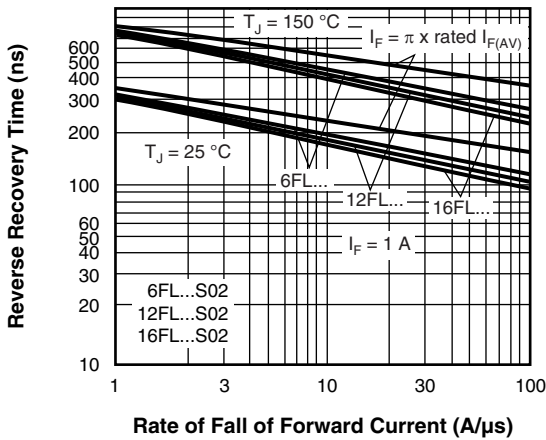

Fig. 17a - Typical Reverse Recovery Time vs. Rate of Fall of Forward Current, All Series...S02

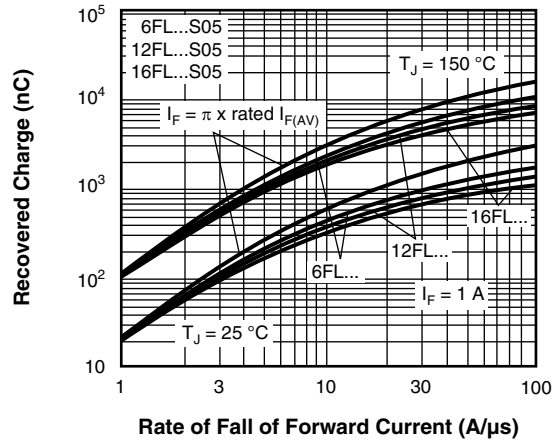

Fig. 18b - Typical Recovered Charge vs. Rate of Fall of Forward Current, All Series...S05

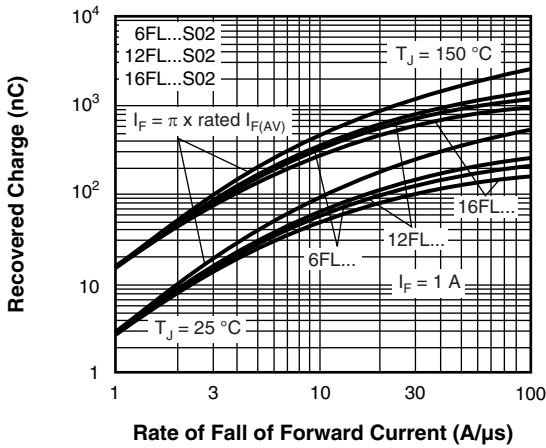

Fig. 17b - Typical Recovered Charge vs. Rate of Fall of Forward Current, All Series...S02

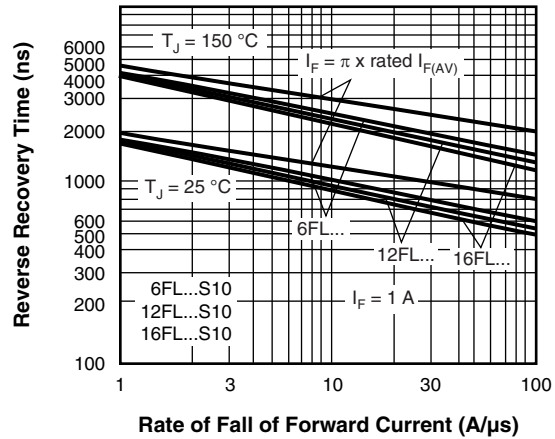

Fig. 19a - Typical Reverse Recovery Time vs. Rate of Fall of Forward Current, All Series...S10

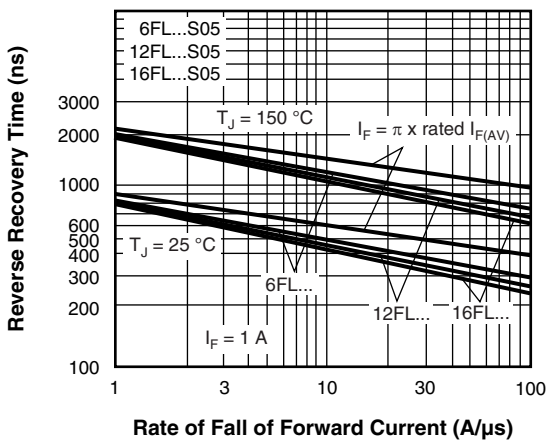

Fig. 18a - Typical Reverse Recovery Time vs. Rate of Fall of Forward Current, All Series...S05

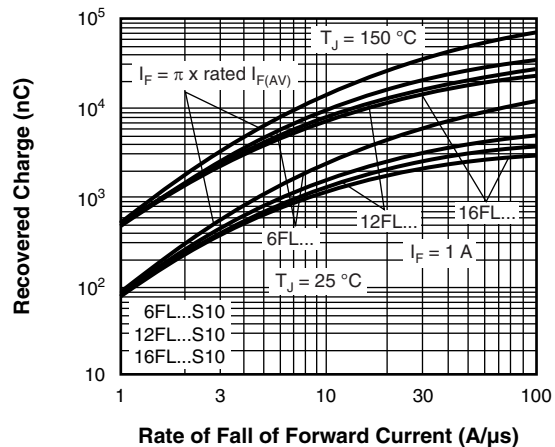

Fig. 19b - Typical Recovered Charge vs. Rate of Fall of Forward Current, All Series...S10

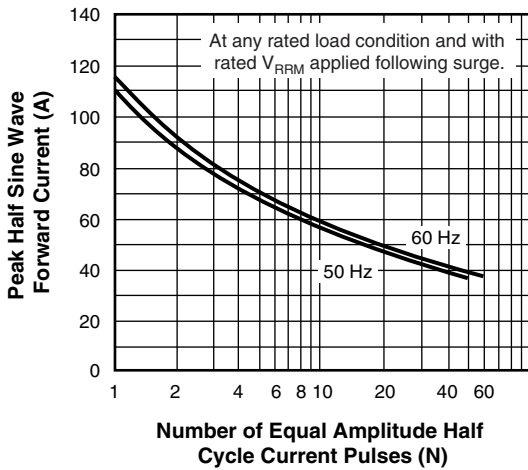

Fig. 20 - Maximum Non-Repetitive Surge Current vs. Number of Current Pulses, 6FL Series

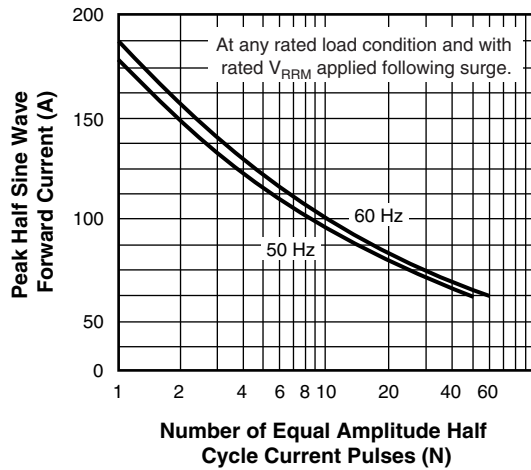

Fig. 22 - Maximum Non-Repetitive Surge Current vs. Number of Current Pulses, 16FL Series

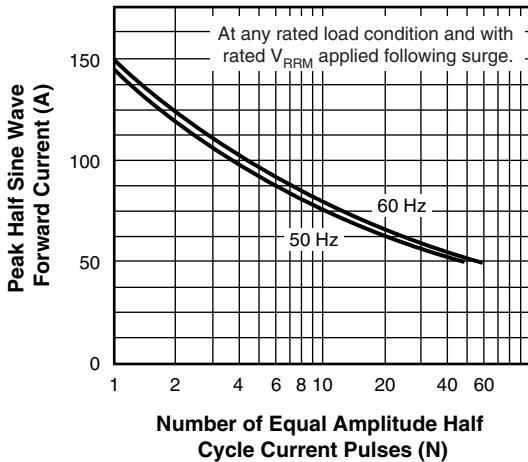

Fig. 21 - Maximum Non-Repetitive Surge Current vs. Number of Current Pulses, 12FL Series

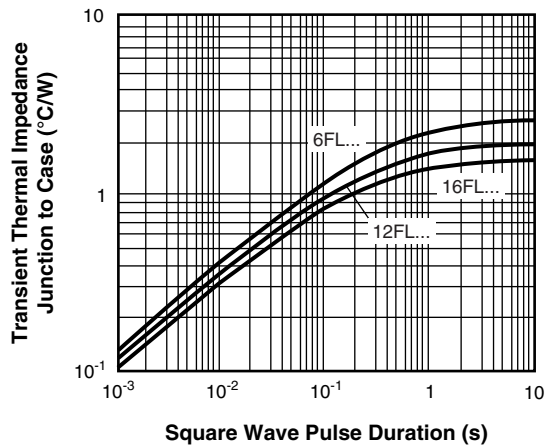
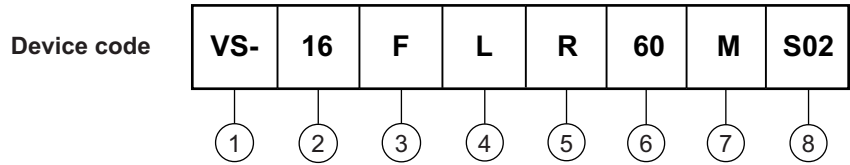

Fig. 23 - Maximum Transient Thermal Impedance, Junction to Case vs. Pulse Duration, All Series



ORDERING INFORMATION TABLE



- 1** - Vishay Semiconductors product
- 2** - Current code $I_{(AVG)}$ = exact current rating
- 3** - F = diode
- 4** - Omit = standard recovery diode
L = only for fast diode
- 5** - Omit = stud forward polarity
R = stud reverse polarity
- 6** - Voltage code x 10 = V_{RRM} (see Voltage Ratings table)
- 7** - Outlines:
Omit = stud base UNF thread
M = stud base metric thread
- 8** - t_{rr} code only for fast diode (see Recovery Characteristics table)

LINKS TO RELATED DOCUMENTS	
Dimensions	www.vishay.com/doc?95311

DO-203AA (DO-4)

DIMENSIONS in millimeters (inches)

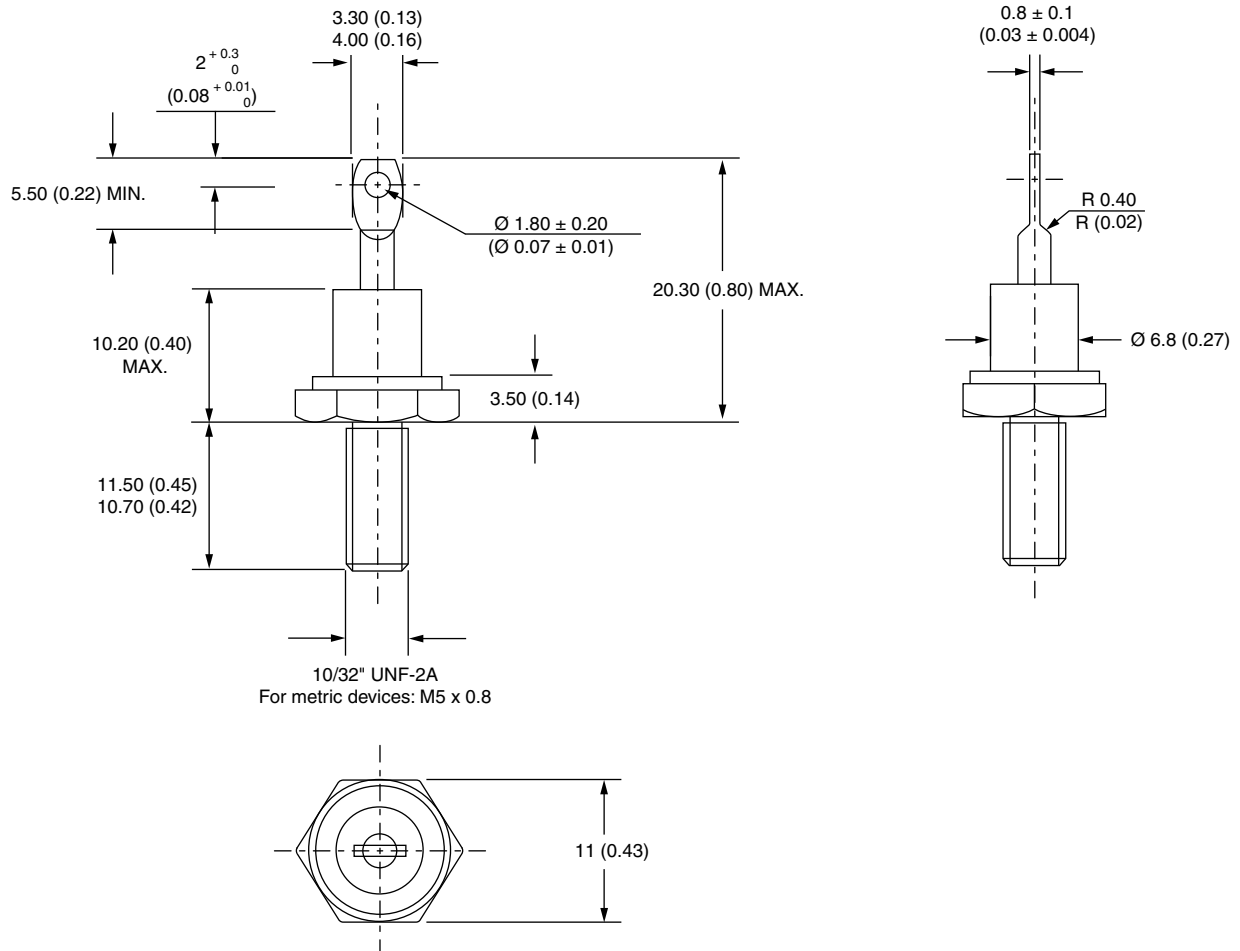



Disclaimer

ALL PRODUCT, PRODUCT SPECIFICATIONS AND DATA ARE SUBJECT TO CHANGE WITHOUT NOTICE TO IMPROVE RELIABILITY, FUNCTION OR DESIGN OR OTHERWISE.

Vishay Intertechnology, Inc., its affiliates, agents, and employees, and all persons acting on its or their behalf (collectively, "Vishay"), disclaim any and all liability for any errors, inaccuracies or incompleteness contained in any datasheet or in any other disclosure relating to any product.

Vishay makes no warranty, representation or guarantee regarding the suitability of the products for any particular purpose or the continuing production of any product. To the maximum extent permitted by applicable law, Vishay disclaims (i) any and all liability arising out of the application or use of any product, (ii) any and all liability, including without limitation special, consequential or incidental damages, and (iii) any and all implied warranties, including warranties of fitness for particular purpose, non-infringement and merchantability.

Statements regarding the suitability of products for certain types of applications are based on Vishay's knowledge of typical requirements that are often placed on Vishay products in generic applications. Such statements are not binding statements about the suitability of products for a particular application. It is the customer's responsibility to validate that a particular product with the properties described in the product specification is suitable for use in a particular application. Parameters provided in datasheets and / or specifications may vary in different applications and performance may vary over time. All operating parameters, including typical parameters, must be validated for each customer application by the customer's technical experts. Product specifications do not expand or otherwise modify Vishay's terms and conditions of purchase, including but not limited to the warranty expressed therein.

Hyperlinks included in this datasheet may direct users to third-party websites. These links are provided as a convenience and for informational purposes only. Inclusion of these hyperlinks does not constitute an endorsement or an approval by Vishay of any of the products, services or opinions of the corporation, organization or individual associated with the third-party website. Vishay disclaims any and all liability and bears no responsibility for the accuracy, legality or content of the third-party website or for that of subsequent links.

Except as expressly indicated in writing, Vishay products are not designed for use in medical, life-saving, or life-sustaining applications or for any other application in which the failure of the Vishay product could result in personal injury or death. Customers using or selling Vishay products not expressly indicated for use in such applications do so at their own risk. Please contact authorized Vishay personnel to obtain written terms and conditions regarding products designed for such applications.

No license, express or implied, by estoppel or otherwise, to any intellectual property rights is granted by this document or by any conduct of Vishay. Product names and markings noted herein may be trademarks of their respective owners.