

IEC Appliance Inlet with protection degree IP67 / IP69K, Screw-on Mounting front side, Solder or Quick-connect Terminal

new



4761
 Connector
 black

with Cover (separate accessories)

Set consisting of appliance inlet and connector



See below:
[Approvals and Compliances](#)

Description

- Panel mount :
 Screw-on mounting front side
- Appliance Inlet , Pin temperature 120 °C , Protection class I
- Solder / Quick Connect
- Complete set consisting of appliance inlet and outlet
- Mating connector type: 4762

Unique Selling Proposition

- Waterproofed Appliance Inlet IP67 / IP69K
- Suitable for equipments in harsh environment
- Specific shape to ensure IP protection
- Version in Black and White

Weblinks

[pdf data sheet](#), [html datasheet](#), [General Product Information](#), [Approvals](#), [Distributor-Stock-Check](#), [Accessories](#), [Detailed request for product](#), [Microsite](#), [Video](#)

Technical Data

Ratings IEC	10A / 250VAC; 50Hz
Ratings UL/CSA	15A / 250VAC; 60Hz
Dielectric Strength	> 1.5kVAC between L-N > 1.5kVAC between L/N-PE (1 min/50Hz)
Allowable Operation Temperature	-25 °C to 120 °C
IP-Protection	front side IP67 acc. to IEC 60529 / IP69K acc. to ISO 20653
Protection against electric shock	Suitable for appliances with protection class I acc. to IEC 61140
Terminal	Solder / Quick Connect
Panel Thickness S	Screw: max 6 mm Mounting screw torque max 3Nm
Material: Housing	Thermoplastic, black / white, UL 94V-0

Appliance inlet/-outlet	S16 acc. to IEC 60320-1, UL 60320-1, CSA C22.2 no. 60320-1 (For hot conditions) pin-temperature 120 °C, 10A, Protection Class I Shape of connector S16 is SCHURTER specific
-------------------------	--

Approvals and Compliances

Detailed information on product approvals, code requirements, usage instructions and detailed test conditions can be looked up in [Details about Approvals](#)

SCHURTER products are designed for use in industrial environments. They have approvals from independent testing bodies according to national and international standards. Products with specific characteristics and requirements such as required in the automotive sector according to IATF 16949, medical technology according to ISO 13485 or in the aerospace industry can be offered exclusively with customer-specific, individual agreements by SCHURTER.



Approvals

The approval mark is used by the testing authorities to certify compliance with the safety requirements placed on electronic products.
 Approval Reference Type: 4761

Approval Logo	Certificates	Certification Body	Description
	VDE Approvals	VDE	Certificate Number: 40044311
	UL Approvals	UL	UL File Number: E96454

Product standards

Product standards that are referenced

Organization	Design	Standard	Description
	Designed according to	IEC 60320-1	Appliance couplers for household and similar general purposes
	Designed according to	UL 60320-1	Standard for Attachment Plugs and Receptacles
	Designed according to	CSA C22.2 no. 60320-1	General Use Receptacles, Attachment Plugs, and Similar Wiring Devices







Application standards

Application standards where the product can be used

Organization	Design	Standard	Description
	Designed for applications acc.	IEC/UL 62368-1	Audio/video, information and communication technology equipment - Part 1: Safety requirements

Compliances

The product complies with following Guide Lines

Identification	Details	Initiator	Description
	CE declaration of conformity	SCHURTER AG	The CE marking declares that the product complies with the applicable requirements laid down in the harmonisation of Community legislation on its affixing in accordance with EU Regulation 765/2008.
	UKCA declaration of conformity	SCHURTER AG	The UKCA marking declares that the product complies with the applicable requirements laid down in the British Amendment of Regulation (EC) 765/2008.
	RoHS	SCHURTER AG	Directive RoHS 2011/65/EU, Amendment (EU) 2015/863
	China RoHS	SCHURTER AG	The law SJ / T 11363-2006 (China RoHS) has been in force since 1 March 2007. It is similar to the EU directive RoHS.
	Halogen Free	SCHURTER AG	SCHURTER strives to offer our customers halogen free products.
	REACH	SCHURTER AG	On 1 June 2007, Regulation (EC) No 1907/2006 on the Registration, Evaluation, Authorization and Restriction of Chemicals 1 (abbreviated as "REACH") entered into force.

Dimensions [mm]

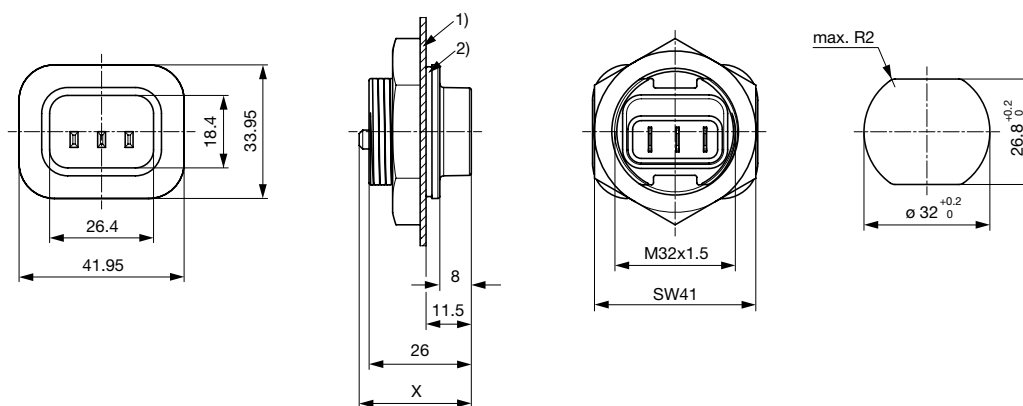

X: Quick-connect terminals 4.8x0.8 mm: 28.5 mm

X: Quick-connect terminals 6.3x0.8 mm: 31.0 mm

X: Solder terminals: 25.5 mm

1) Panel

2) Gasket or protection cover

All Variants

Appliance Inlet	Connector	Kit	Color	Terminals Inlet	Order Number
●		-	black	Quick connect terminals 4.8 x 0.8 mm	4312.0000
●		-	black	Quick connect terminals 6.3 x 0.8 mm	4312.0001
●		-	black	Solder terminals	4312.0002
●	●	1)	black	Quick connect terminals 4.8 x 0.8 mm	4312.0004
●	●	1)	black	Quick connect terminals 6.3 x 0.8 mm	4312.0005
●	●	1)	black	Solder terminals	4312.0006
●		-	white	Quick connect terminals 4.8 x 0.8 mm	4312.0007
●		-	white	Quick connect terminals 6.3 x 0.8 mm	4312.0008
●		-	white	Solder terminals	4312.0009
●	●	1)	white	Quick connect terminals 4.8 x 0.8 mm	4312.0011
●	●	1)	white	Quick connect terminals 6.3 x 0.8 mm	4312.0012
●	●	1)	white	Solder terminals	4312.0013

1) complete set consisting of appliance inlet and outlet

Most Popular.

Availability for all products can be searched real-time: <https://www.schurter.com/en/Stock-Check/Stock-Check-SCHURTER>

Packaging unit

10 Pcs

Accessories

Description



Protection cover
 Protection cover for waterproof appliance coupler 4761 / 4762

Mating Outlets/Connectors shuttered

Category / Description



Connector Overview complete

4762 Mounting: Power Cord, 3 x 1 mm² / 3 x 18 AWG, Cable, Connector: S15

4762