

Fuer diese Unterlage behalten wir uns alle Rechte vor, auch fuer den Fall der Patenterteilung oder Gebrauchsmustererteilung. Sie darf ohne unsere vorherige schriftliche Zustimmung weder vervielfaeltigt noch sonstwie benutzt, noch Dritten zuganglich gemacht werden.

Mur rol gestempelte oder auf Laufkarte gedruckte Dokumente unterliegen dem Aenderungsdiens und sind zur Fertigung freigegeben. Only red stamped or on jobcard printed documents are managed. These documents are approved for production.

All Rights reserved, including possible patents or trademarks. Documents shall not be provided to a third party or duplicated in any form without prior written permission.

CAD: Creo Parametric

nur Einsatz dargestellt!  
view only insert!

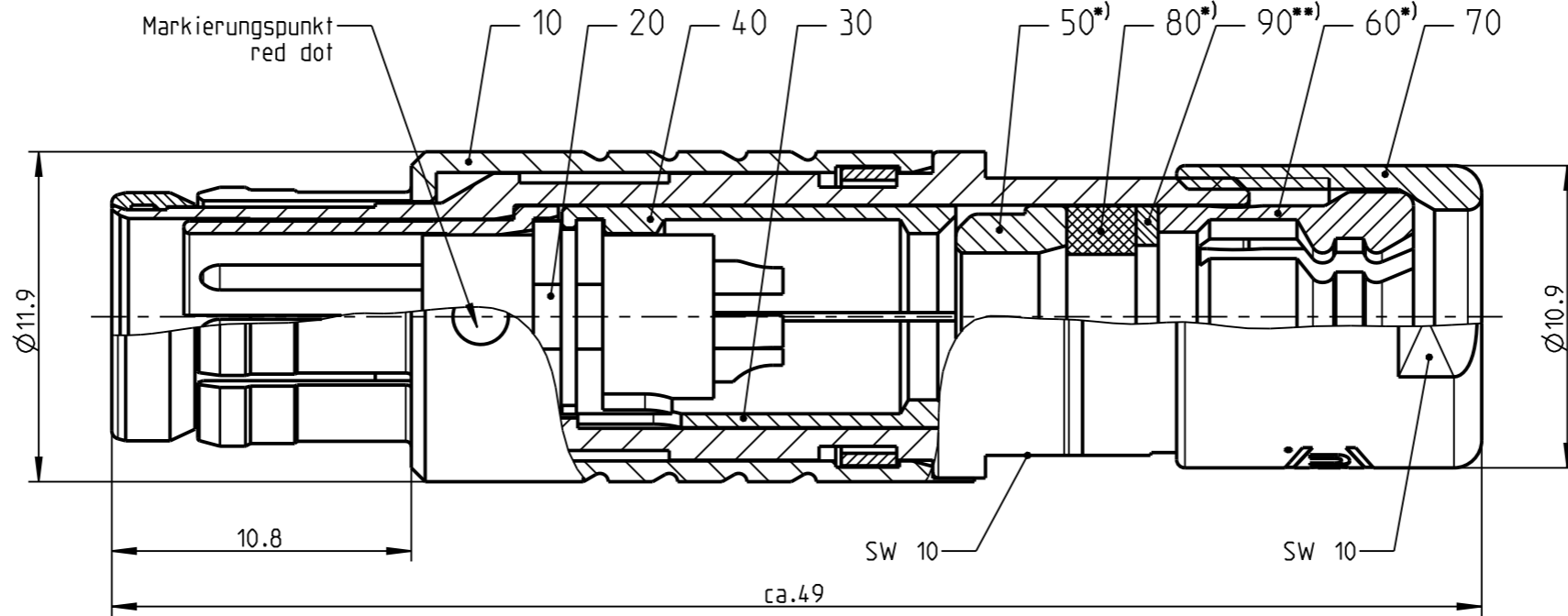
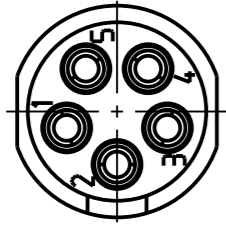

Anzugsdrehmoment: 1.0 Nm  
torque value:

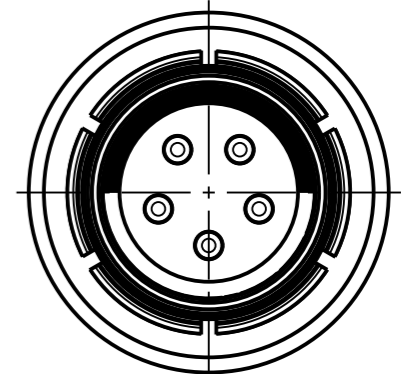

S31F1C - \_\_\_

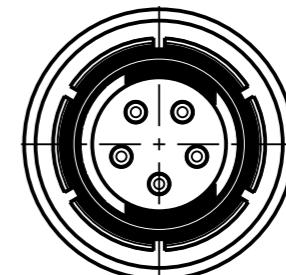

S31F2C - \_\_\_

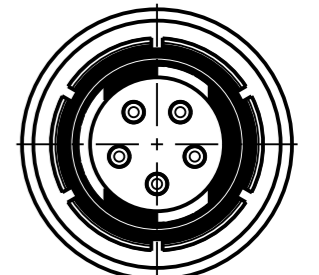

S31F3C - \_\_\_

empfohlene Abisolierlaenge  
/recommended cable preparation

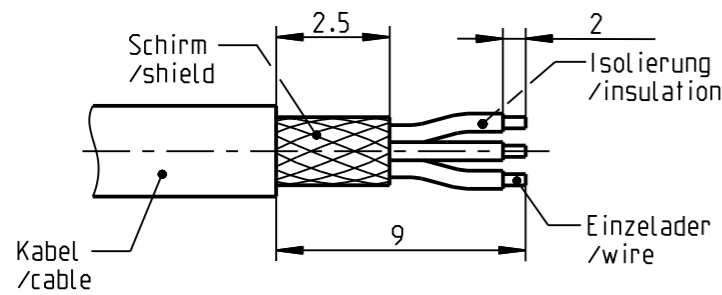

\*) Darstellung nur Beispiel!  
figure only for example!  
\*\*) Scheibe nur bei Kabel-Ø ≤ 4.5mm!  
washer only at cable-Ø ≤ 4.5mm!

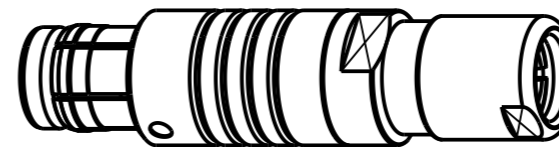

Technische Daten/Technical Data:

|   |                                      |  |  |
|---|--------------------------------------|--|--|
| Werkstoffe/Materials:<br>Gehaeuse/Housing:  | Cu-Legierung<br>/cu-alloy            | KontaktØ/ContactØ:<br>Anschluß/Termination:<br>Loet/solder     | Ø0.9 mm<br>0.38mm <sup>2</sup><br>AWG 22 |
| Kontakte/Contacts:                          | Cu-Legierung<br>/cu-alloy            | Pruefspannung/Test Voltage:                                    | 1.35 kV AC (SAE AS 13441)                |
| Isolierkoerper/Insulation Body:             | PEEK                                 | Strombelastung/Current Load:<br>Einzelkontakte/single contacts | 10 A                                     |
| Oberflaechen/Surfaces:<br>Gehaeuse/Housing: | matt verchromt<br>matt chrome-plated |  |  |
| Kontakte/Contacts:                          | gal. Au                              |  |  |

Schutzart im gesteckten Zustand: IP 68  
/Protection Class in mated condition

Bei den hier dargestellten ODU-Steckverbindern handelt es sich nach DIN EN 61984:2009 um Steckverbinder ohne Schaltleistung (COC) !  
/the pictured ODU-connectors are in relation to DIN EN 61984:2009 connectors without switching capacity (COC) !

|                               |                   |
|-------------------------------|-------------------|
| S31F_C-P05MJG0-7000           | > 6.5 - 7.0 mm    |
| S31F_C-P05MJG0-6500           | > 6.0 - 6.5 mm    |
| S31F_C-P05MJG0-6000           | > 5.5 - 6.0 mm    |
| S31F_C-P05MJG0-5500           | > 5.0 - 5.5 mm    |
| S31F_C-P05MJG0-5000           | > 4.5 - 5.0 mm    |
| S31F_C-P05MJG0-4500           | > 4.0 - 4.5 mm    |
| S31F_C-P05MJG0-4000           | > 3.5 - 4.0 mm    |
| S31F_C-P05MJG0-3500           | > 3.0 - 3.5 mm    |
| S31F_C-P05MJG0-3000           | > 2.5 - 3.0 mm    |
| S31F_C-P05MJG0-2500           | > 2.0 - 2.5 mm    |
| S31F_C-P05MJG0-2000           | > 1.5 - 2.0 mm    |
| S31F_C-P05MJG0-1500           | > 1.0 - 1.5 mm    |
| Artikelnummer/<br>part number | KabelØ/<br>cableØ |

|   |                         |  |                                    |
|---|-------------------------|--|------------------------------------|
|   |                         | Benennung/description:<br>STECKER CPL. | Werkstoff:<br>material:<br>see BOM |
| Allgemeintoleranz/general tol.:<br>DIN ISO 2768-mH<br>Tolerierung / Tolerancing:<br>DIN ISO 8015<br>Status/state: <b>Approved</b> |                         | CAD-Nr.:<br>design-ID: <b>00104292</b> | Maßstab:<br>scale: <b>4:1</b>      |
| Erstellt/prepared: 29.03.2016 srueckerl   | Version:<br>revision: - | Teile-ID:<br>part-ID:                  | Format:<br>size: <b>A3</b>         |
| Geaendert/revised: 29.03.2016 srueckerl   |                         | Oxaion-Nr.: <b>S31F_C-P05MJG0-__00</b> | Einheit:<br>dim.: mm               |
| Freigabe/released: 30.03.2016 rtrager   |                         | Ursprung/origin.:                      | Bl.:<br>sheet: 1                   |
| ODU-MUEHL DORF  | Datum/date              | Name/name                              |                                    |