



TAOGLAS®



Datasheet

Anam PA.26

Part No:
PA.26A

Description:

4G/3G Ceramic SMD Antenna
Covers most worldwide LTE bands

Features:

Compact High Efficiency Antenna
Patent Pending
Surface Mount Distribution (SMD) – Supplied on Tape & Reel
Dimensions: 35*5*6mm
Manufactured in an IATF16949 Certified Facility
CE Certified
RoHS & Reach Compliant



1. Introduction	3
2. Specifications	4
3. Antenna Characteristics	6
4. Radiation Patterns	8
5. Mechanical Drawing	13
6. Antenna Integration Guide	17
7. Evaluation Board Matching Circuit	20
8. Recommended Reflow Temperature Profile	21
9. Packaging	22
10. Application Note	24
<hr/>	
Changelog	26

Taoglas makes no warranties based on the accuracy or completeness of the contents of this document and reserves the right to make changes to specifications and product descriptions at any time without notice. Taoglas reserves all rights to this document and the information contained herein. Reproduction, use or disclosure to third parties without express permission is strictly prohibited.



1. Introduction

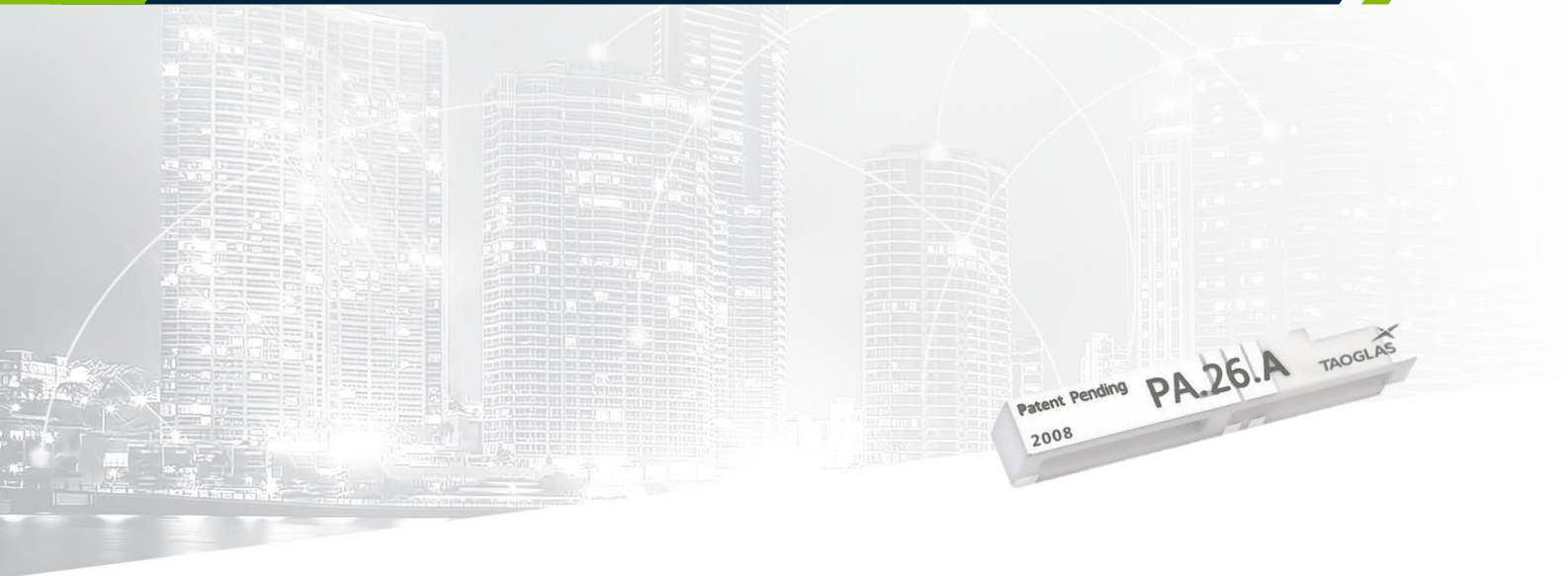

The Taoglas PA.26A is a high-grade ceramic PIFA antenna designed to cover all worldwide 4G bands. The small form factor antenna, with a footprint of just 35x5mm, is designed for direct SMD mounting on device PCBs and provides highest efficiency in the such a small form factor. The PA.26A operates at all common 4G/3G/2G LTE bands from 698MHz to 2700MHz and it also operates with great efficiency on worldwide NB-IoT and CAT-M frequency bands.

The rectangular shape and compact size the PA.26A makes it very easy to integrate and it can be mounted directly on the edge of the PCB. Using SMD antennas (on-board) saves on assembly labor, cable, and connector costs. SMD antennas also result in higher integration yield rates, higher transmit power and higher sensitivity. Matching is accomplished using a pi network. The antenna dimensions and footprint layout are exactly the same as the Taoglas PA.25A, providing customers with an option to easily upgrade from 3G to 4G without a change of PCB architecture.

Typical applications:

- Telematics Control Unit (TCU)
- Medical Devices
- First Responder and Emergency Services
- Intelligent Transport Systems
- HD Video Broadcast Systems over LTE

Close proximity to components or housing affects the electrical performance of all antennas. Care should be taken to follow layout instructions and place antenna on a non-conductive area of the board and there should be adequate clearance of 20mm in all directions from metal components for maximum efficiency. Minimum ground-plane requirements must be met to achieve targeted efficiencies. A reduction in the efficiency of the antenna and a shift in tuned frequency will be observed if these guidelines are not followed. Proximity effects will also have an adverse effect on the radiation pattern of the antenna. Device housings should never be metal or coated with EMI absorption material.

For the PA.26.A we recommend at least 3mm of clearance from the enclosure for best performance. Below 1mm will cause major issues, such as antenna detuning and low radiation efficiency.

Taoglas provides optimization services for matching, and active TRP, TIS and RSE testing. Please contact your regional Taoglas customer support team for further information.

2. Specifications

Electrical									
Band	Frequency (MHz)	Efficiency (%)	Average Gain (dB)	Peak Gain (dBi)	VSWR	Impedance	Polarization	Max Input Power	Radiation Pattern
5G NR/4G Band 12,13,14,17,20,,27,28, 29	698~824	40.8	-4.3	1.1	<3.5:1	50 Ω	Linear	5W	Omni
4G Band 5,8,18,19,20,26,27	824~960	72.8	-1.4	1.8					
4G/3G Band 1,2,3,4,9,23,25,35,39,66	1710~2200	54.7	-2.6	3					
4G/3G Band 30, 40	2300~2400	64	-2	3.9					
4G/3G Band 7,38,41	2490~2690	51.6	-2.9	2.8					
5G NR/4G Band 22,42,43,48,78	3300~3800	27.8	-6	-1.5					

Mechanical	
Dimensions	35*5*6mm
Material	Ceramic
Termination	Ag (environmental-friendly Pb free)
Weight	3g
EVB Connector	SMA(F)
Environmental	
Operation Temperature	-40°C to 85°C
Storage Temperature	-40°C to 105°C
Moisture Sensitivity	Level 3
RoHS Compliant	Yes
REACH Compliant	Yes

5G/4G Bands			
Band Number	5G NR / FR1 / LTE / LTE-Advanced / WCDMA / HSPA / HSPA+ / TD-SCDMA		
	Uplink	Downlink	Covered
1	UL: 1920 to 1980	DL: 2110 to 2170	✓
2	UL: 1850 to 1910	DL: 1930 to 1990	✓
3	UL: 1710 to 1785	DL: 1805 to 1880	✓
4	UL: 1710 to 1755	DL: 2110 to 2155	✓
5	UL: 824 to 849	DL: 869 to 894	✓
7	UL: 2500 to 2570	DL: 2620 to 2690	✓
8	UL: 880 to 915	DL: 925 to 960	✓
9	UL: 1749.9 to 1784.9	DL: 1844.9 to 1879.9	✓
11	UL: 1427.9 to 1447.9	DL: 1475.9 to 1495.9	✗
12	UL: 699 to 716	DL: 729 to 746	✓
13	UL: 777 to 787	DL: 746 to 756	✓
14	UL: 788 to 798	DL: 758 to 768	✓
17	UL: 704 to 716	DL: 734 to 746	✓
18	UL: 815 to 830	DL: 860 to 875	✓
19	UL: 830 to 845	DL: 875 to 890	✓
20	UL: 832 to 862	DL: 791 to 821	✓
21	UL: 1447.9 to 1462.9	DL: 1495.9 to 1510.9	✗
22	UL: 3410 to 3490	DL: 3510 to 3590	✓
23	UL: 2000 to 2020	DL: 2180 to 2200	✓
24	UL: 1625.5 to 1660.5	DL: 1525 to 1559	✗
25	UL: 1850 to 1915	DL: 1930 to 1995	✓
26	UL: 814 to 849	DL: 859 to 894	✓
27	UL: 807 to 824	DL: 852 to 869	✓
28	UL: 703 to 748	DL: 758 to 803	✓
29	UL: -	DL: 717 to 728	✓
30	UL: 2305 to 2315	DL: 2350 to 2360	✓
31	UL: 452.5 to 457.5	DL: 462.5 to 467.5	✗
32	UL: -	DL: 1452 – 1496	✗
35		1850 to 1910	✓
38		2570 to 2620	✓
39		1880 to 1920	✓
40		2300 to 2400	✓
41		2496 to 2690	✓
42		3400 to 3600	✓
43		3600 to 3800	✗
48		3550 to 3700	✓
66	UL: 1710-1780	DL: 2110-2200	✓
71		617 to 698	✗
74/75/76		1427 to 1518	✗
77		3300 to 4200	✗
78		3300 to 3800	✓
79		4400 to 5000	✗

*Covered bands represent 20% efficiency

**Measured on 110*40mm EVB

3. Antenna Characteristics

3.1 Return Loss

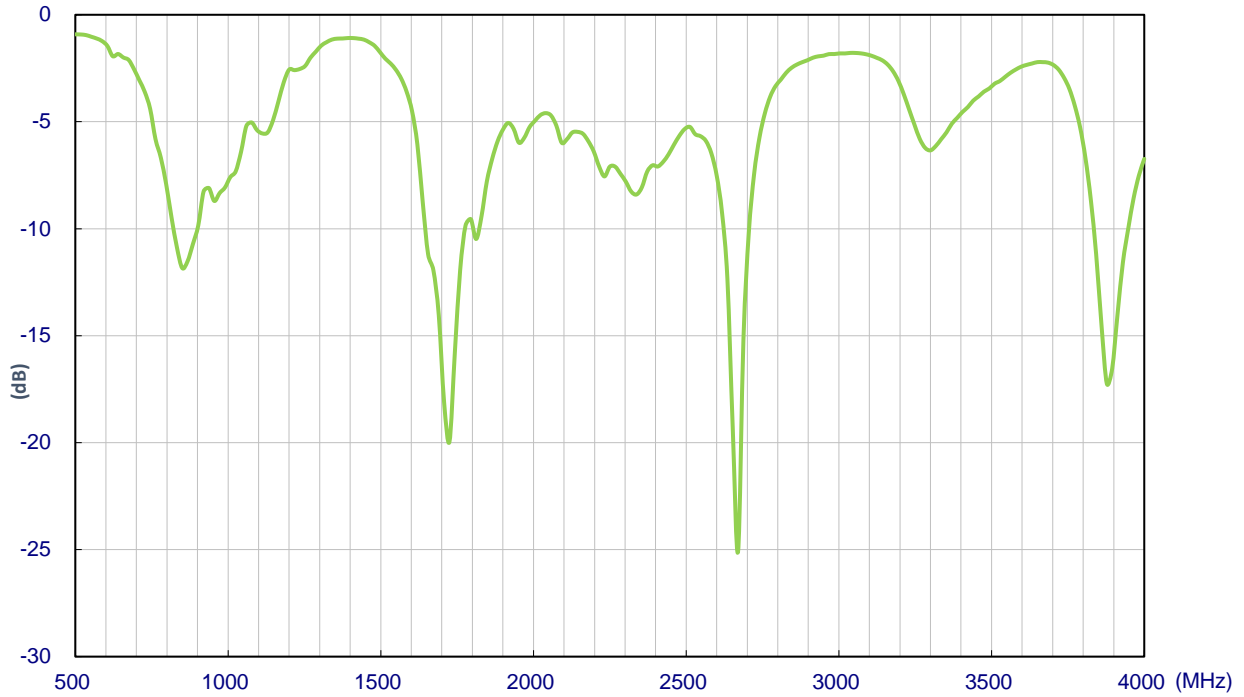

3.2 Efficiency

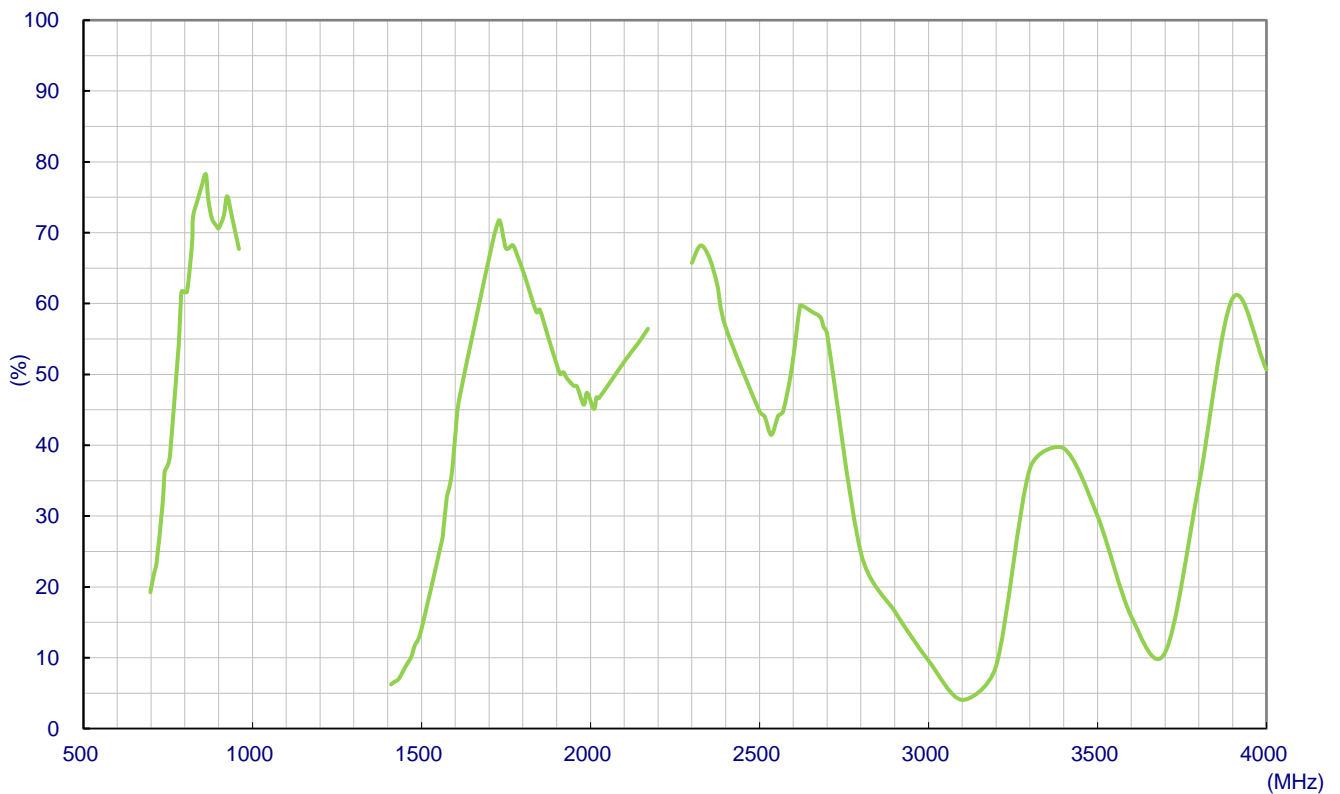

3.3 Average Gain

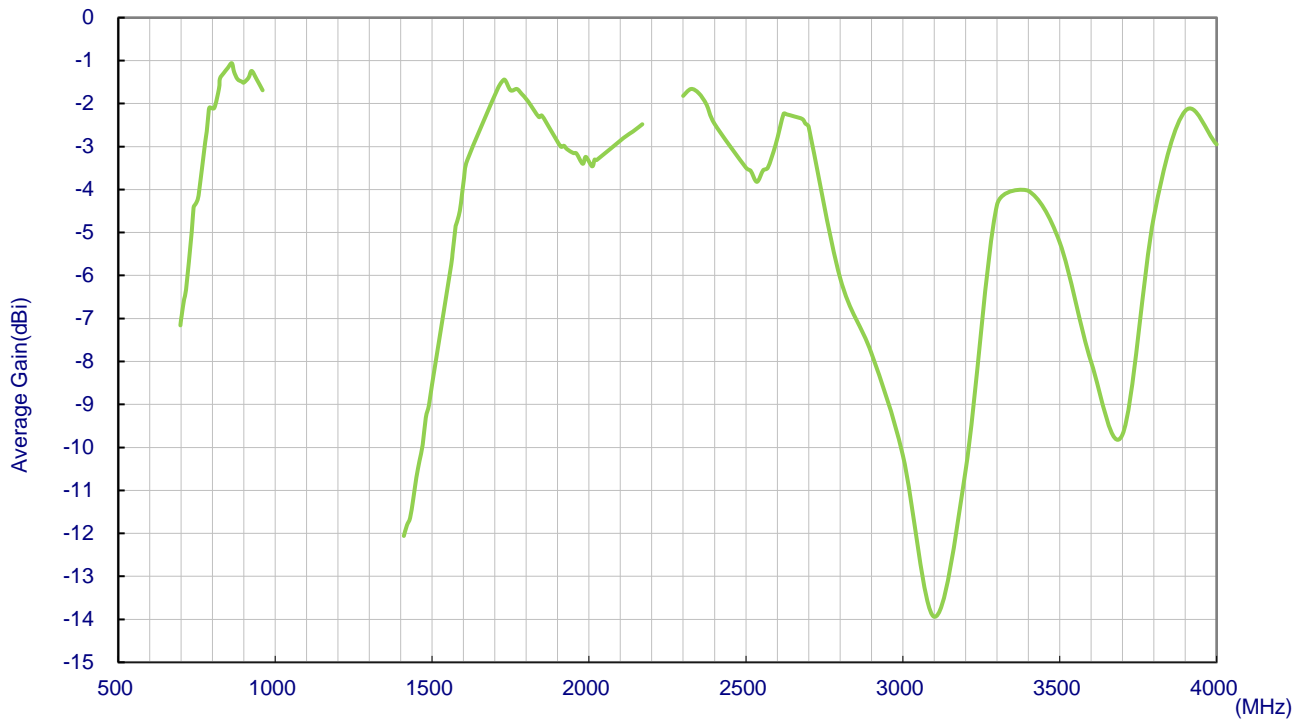

3.4 Peak Gain

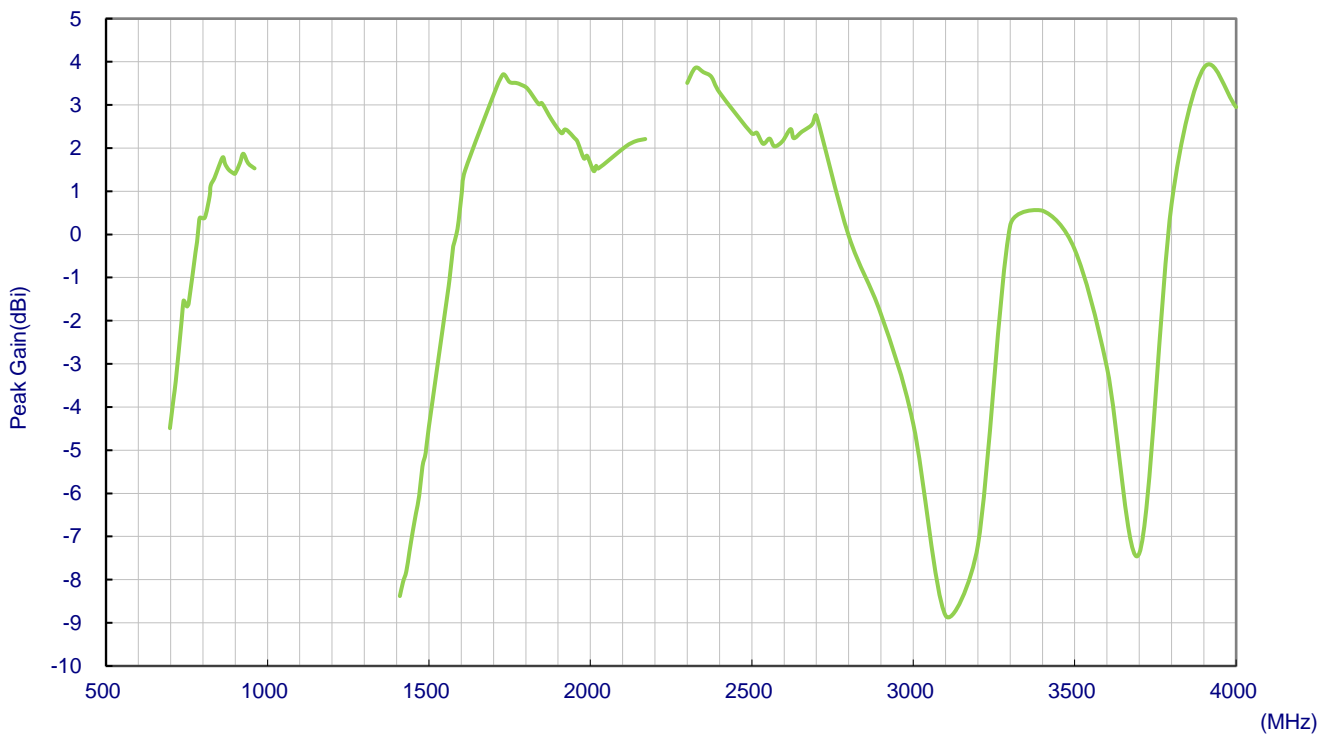

4. Radiation Patterns

4.1 Test Setup – on EVB with 2mm ABS

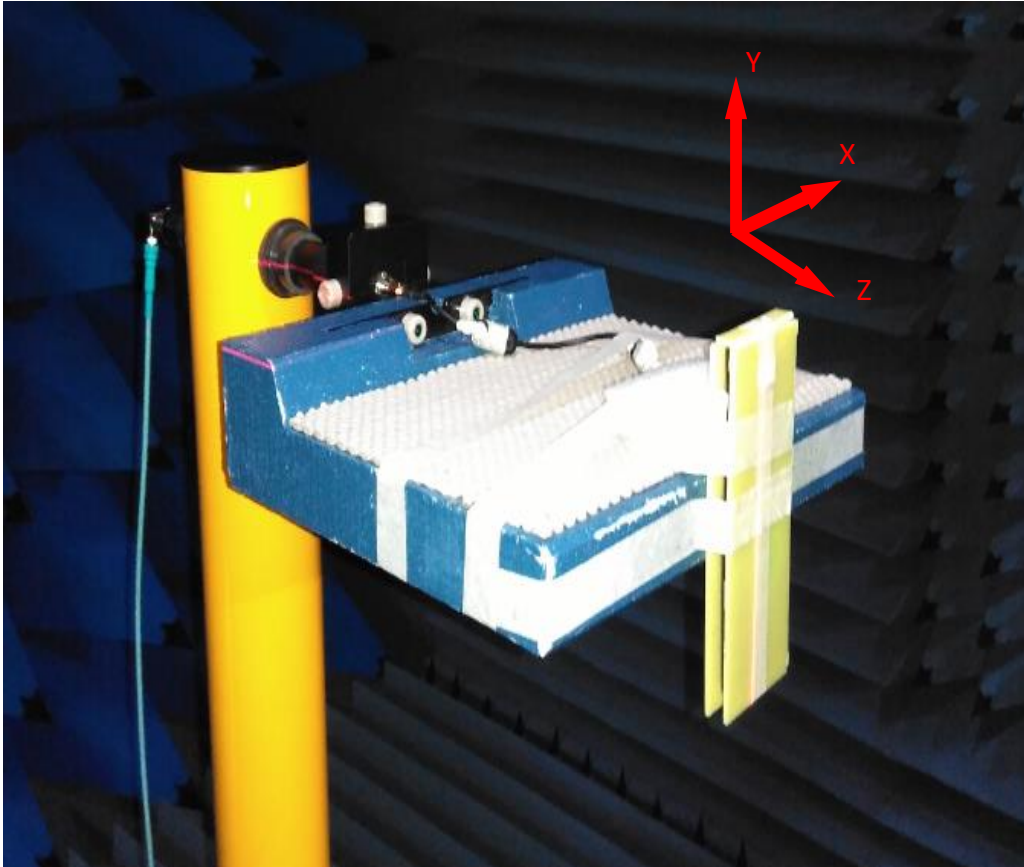

4.2 698-960MHz 3D and 2D Radiation Patterns

704MHz

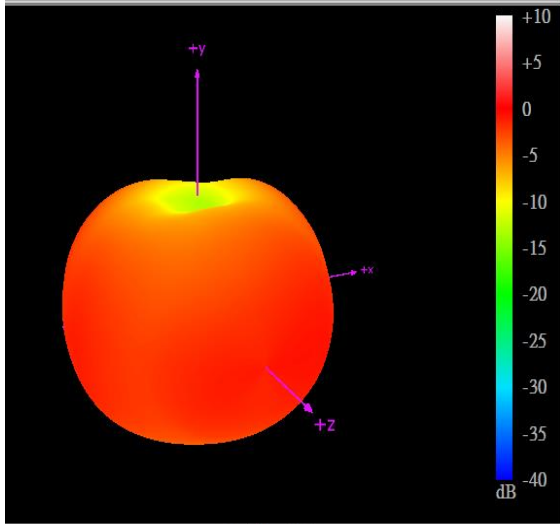

751MHz

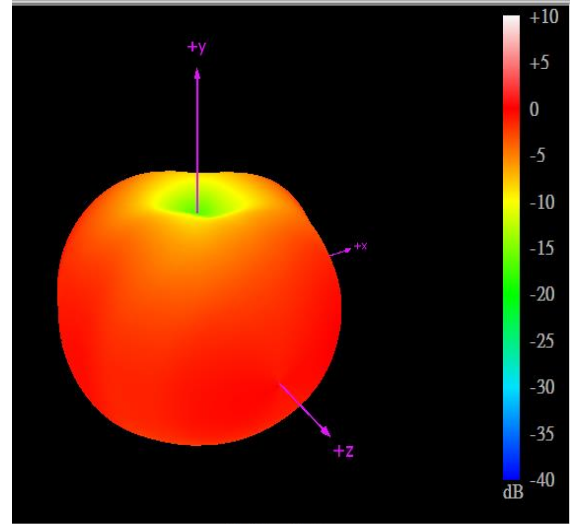

824MHz

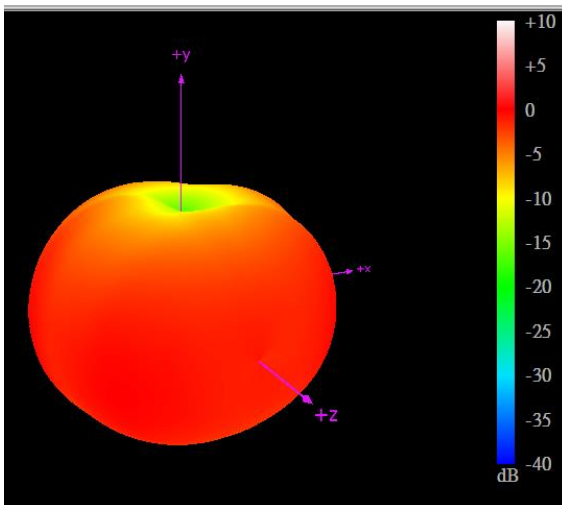

960MHz

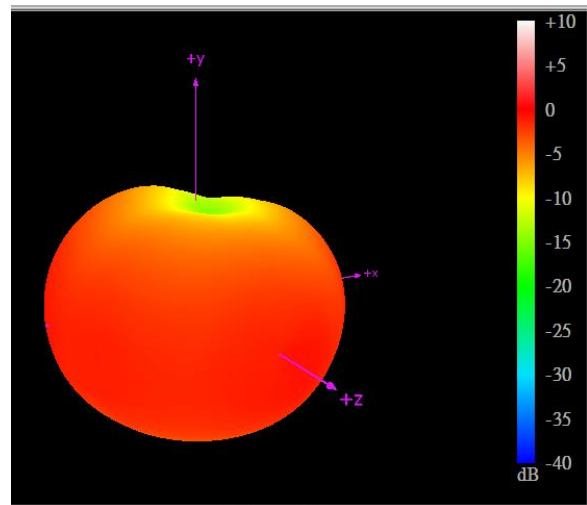

XY Plane

XZ Plane

YZ Plane

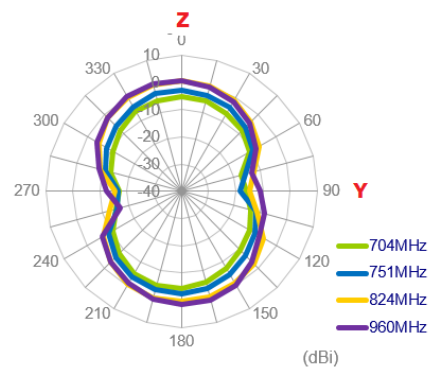
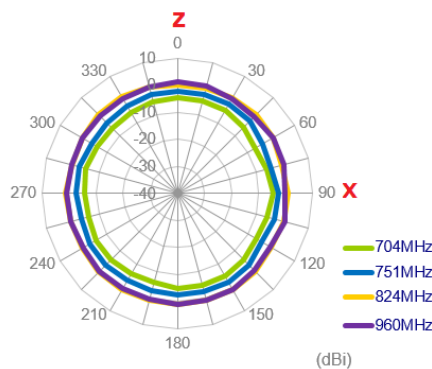
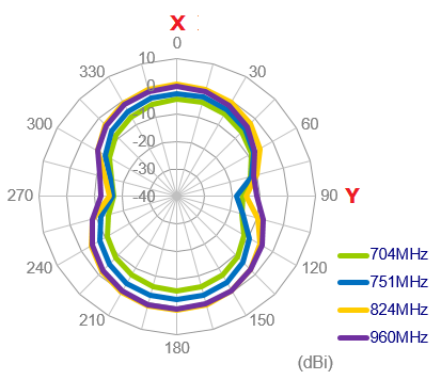

4.3 1710-2170MHz 3D and 2D Radiation Patterns

1710MHz

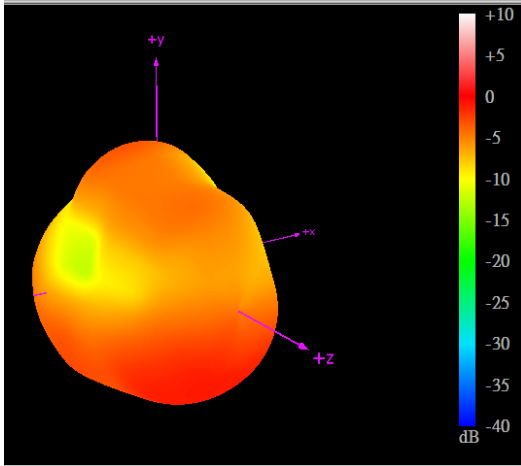

1850MHz

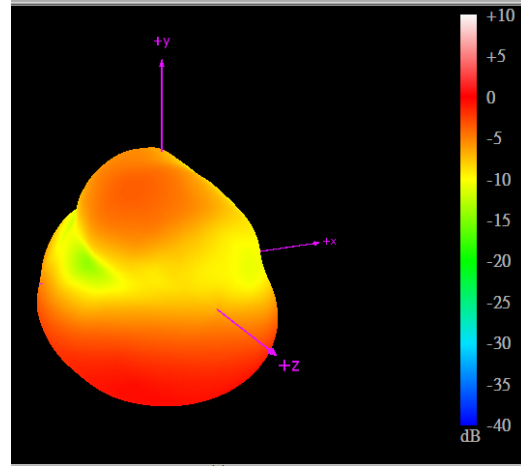

1990MHz

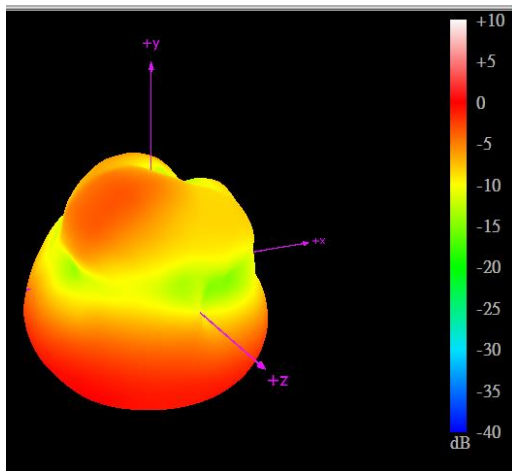

2170MHz

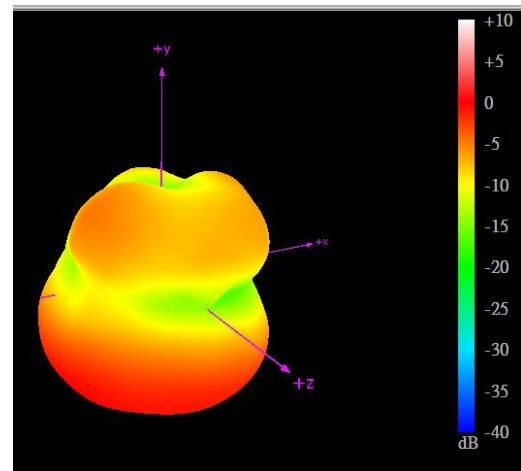

XY Plane

XZ Plane

YZ Plane

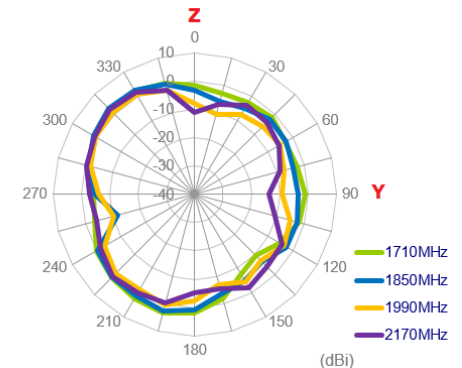
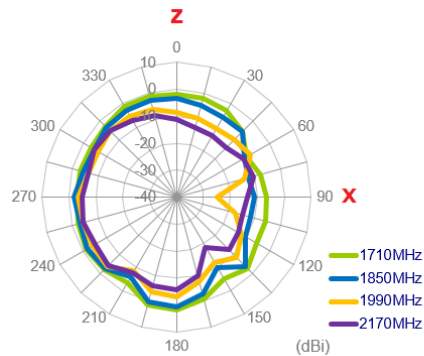
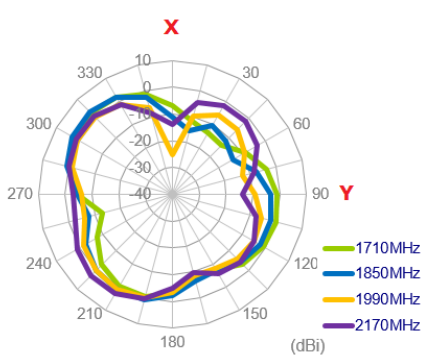

4.4 2490-2690MHz 3D and 2D Radiation Patterns

2500MHz

2690MHz

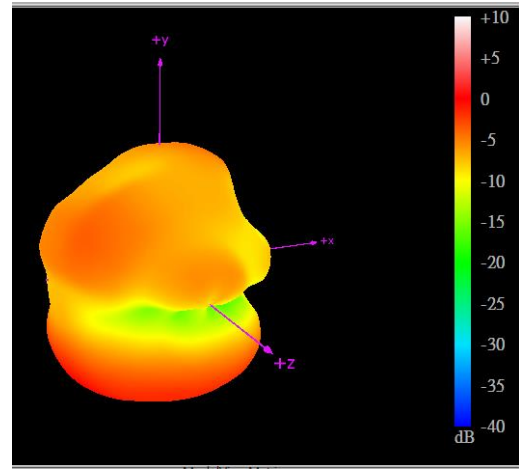
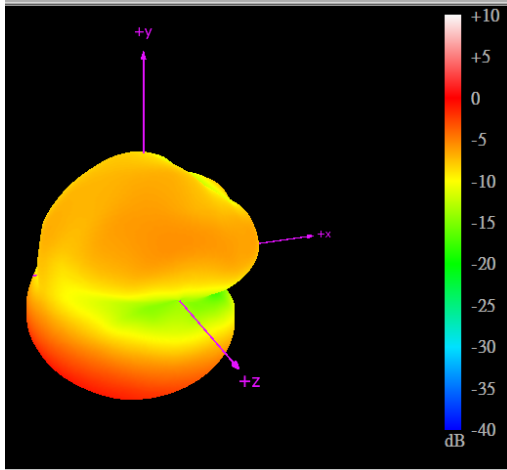

XY Plane

XZ Plane

YZ Plane

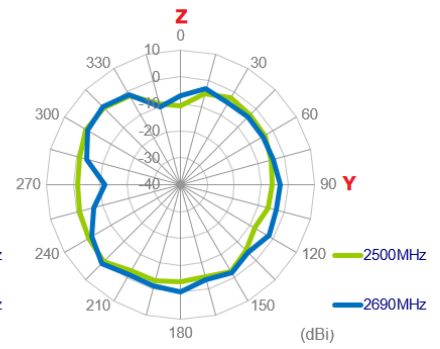
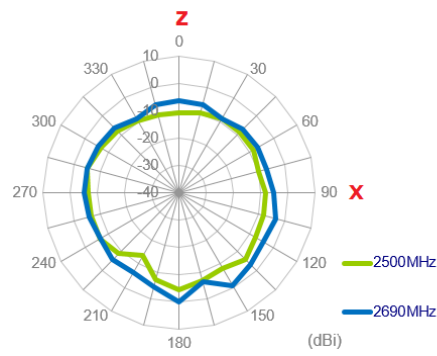
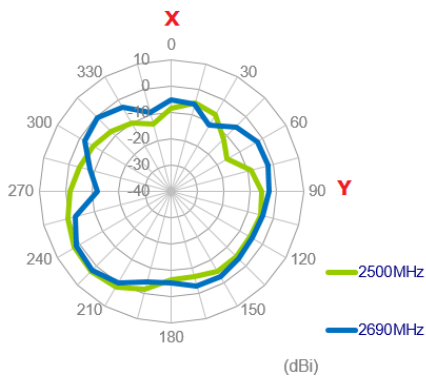

4.5 3400-3600MHz 3D and 2D Radiation Patterns

3500MHz

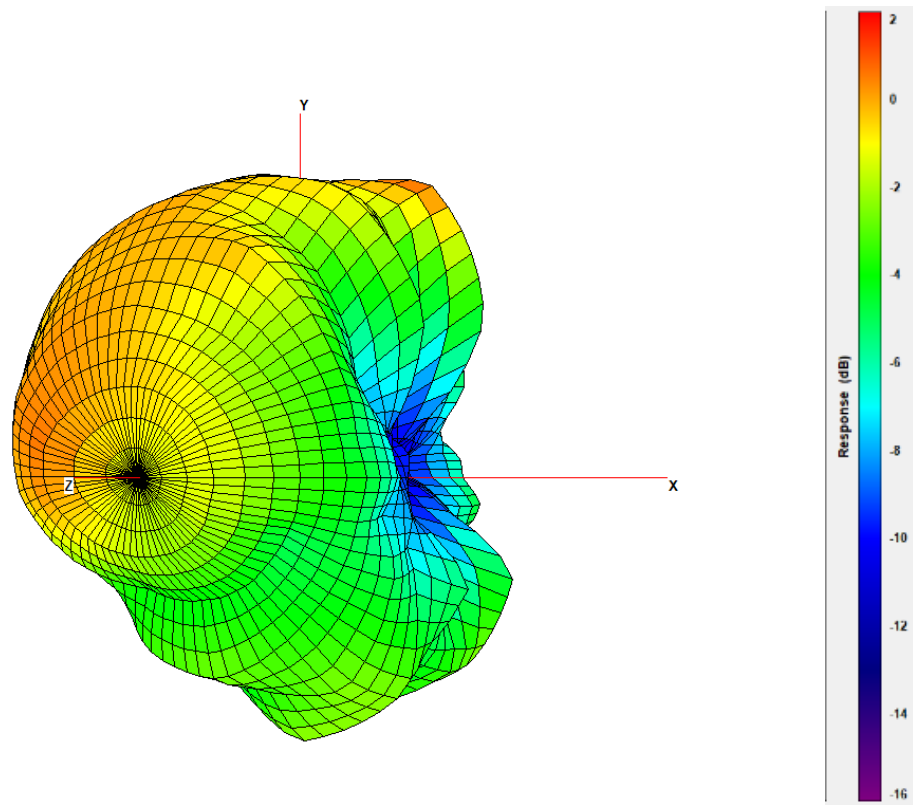

XY Plane

XZ Plane

YZ Plane

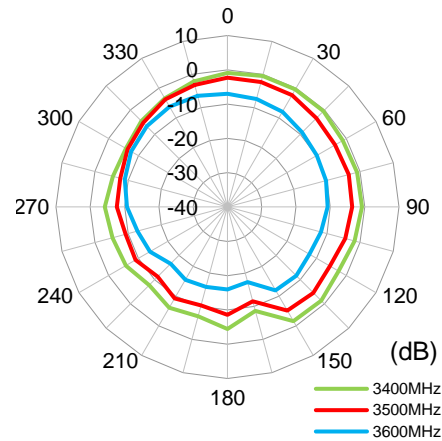
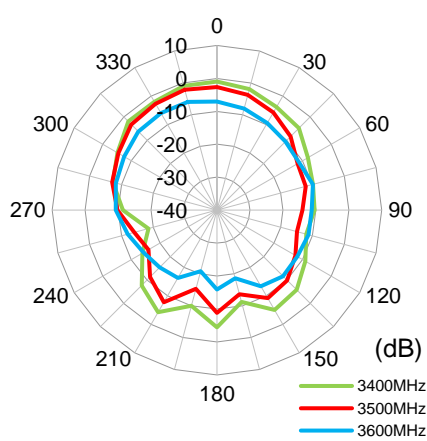
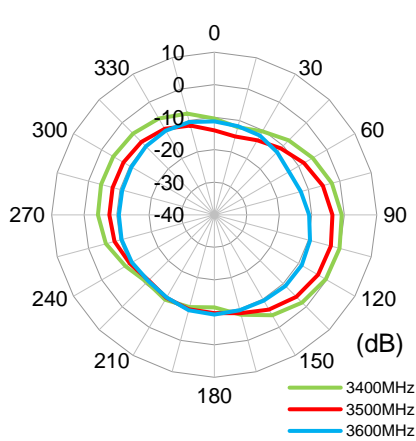

5. Mechanical Drawings(Units: mm)

5.1 Antenna Drawing

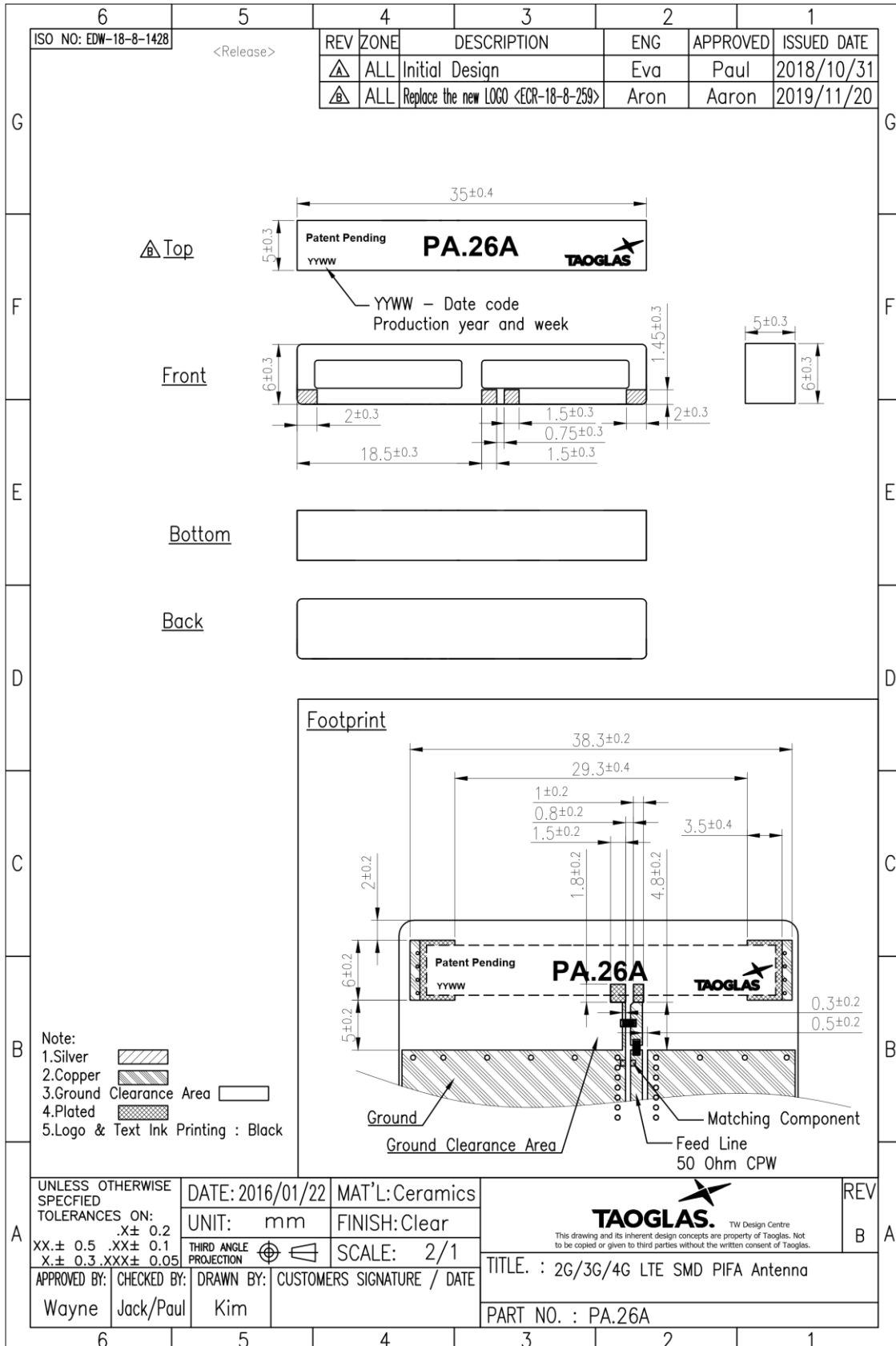

5.2 Footprint Information

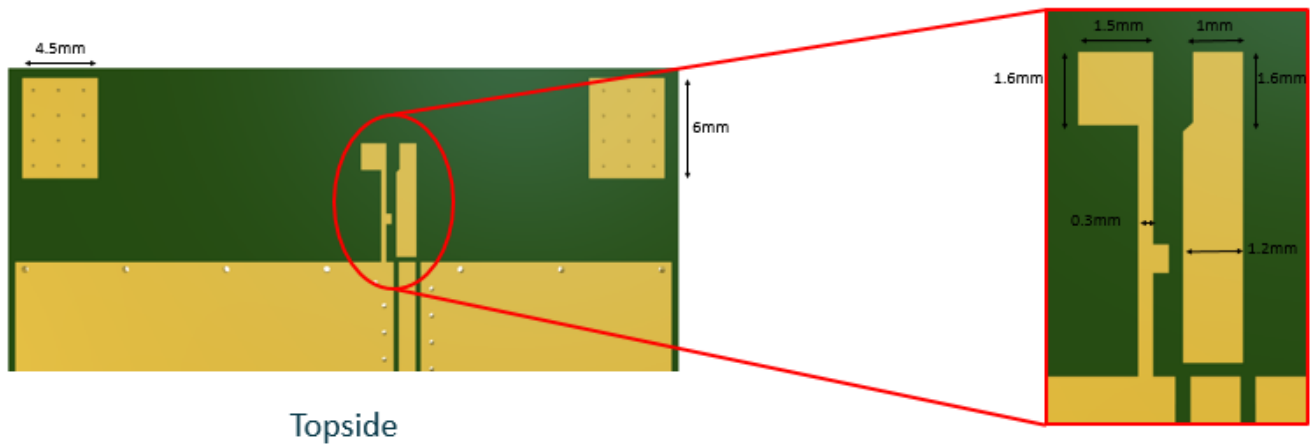

5.3 Vias in Mechanical Pads

Vias are placed in the “no-connect” pads to provide mechanical strength for the pad. These vias are 0.2mm and plated. These vias should be filled with a non-conductive material. Please ensure that the topside surface finish is flat on these pads and the RF Feed and Ground Pad. Vias are covered with soldermask (tented) on the bottom side.



5.4 Evaluation Board

40m

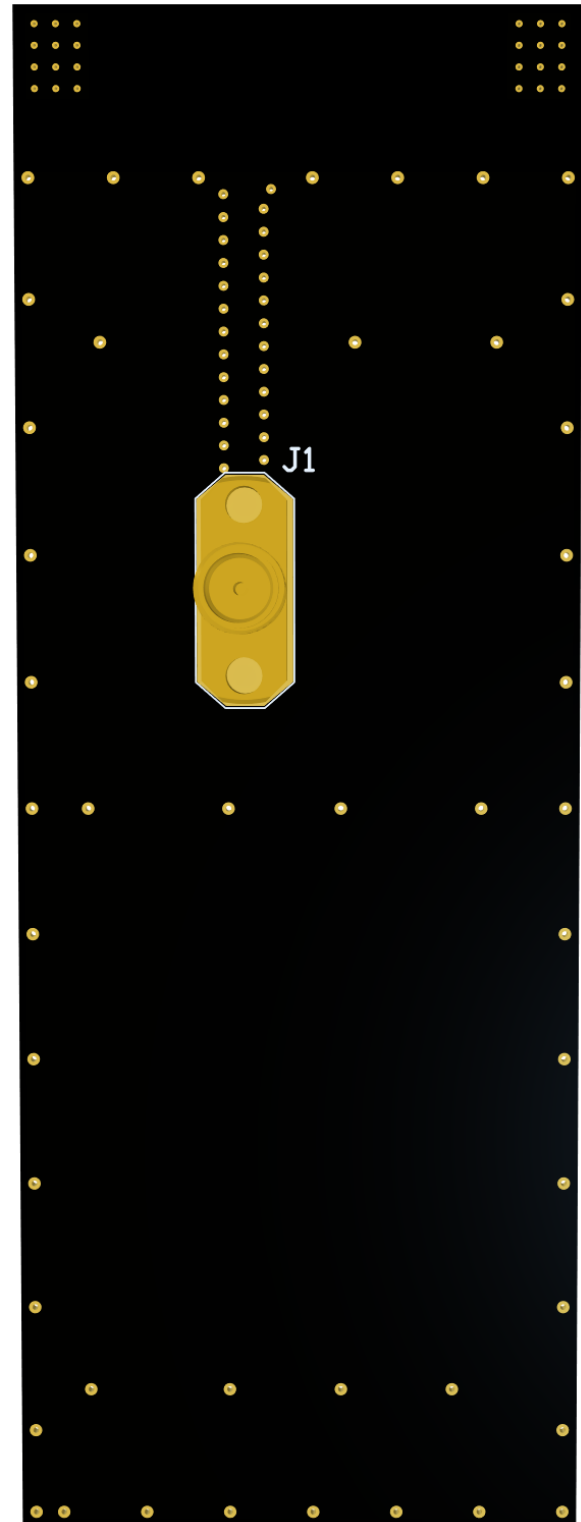
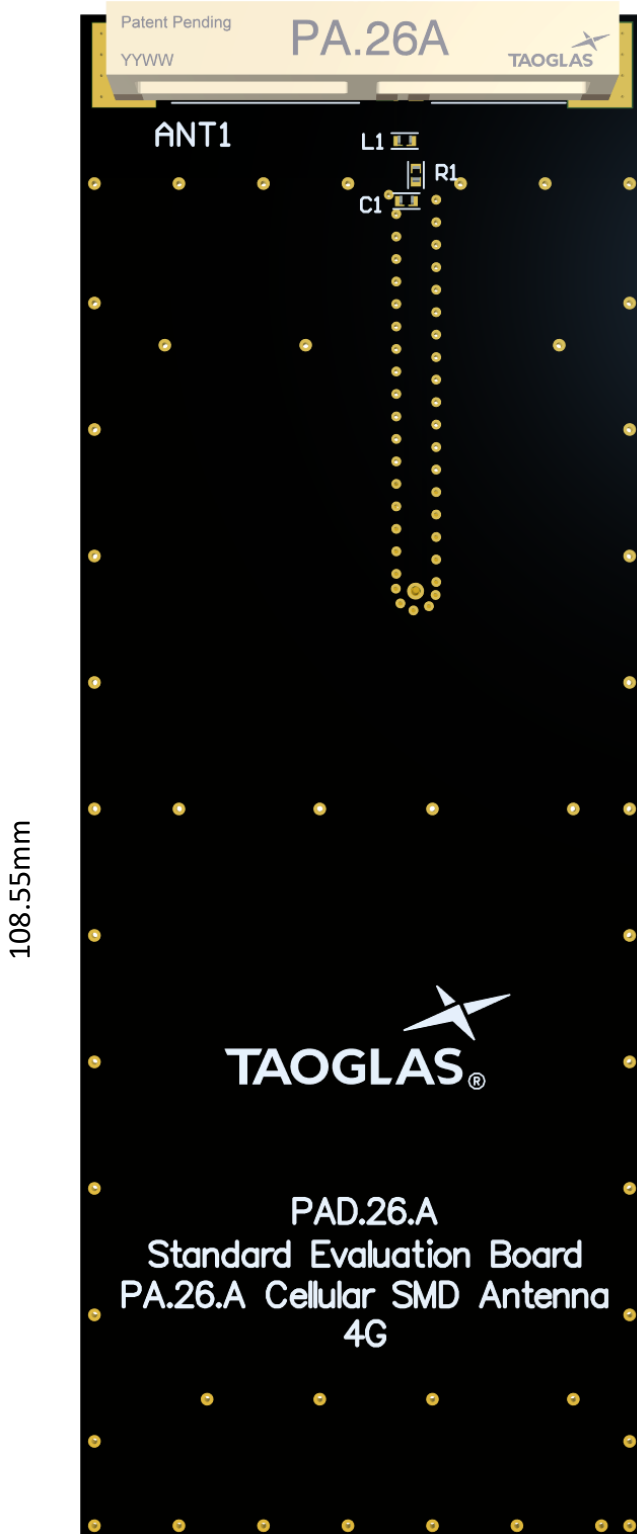

5.5 Evaluation Board – Ground Plane Length

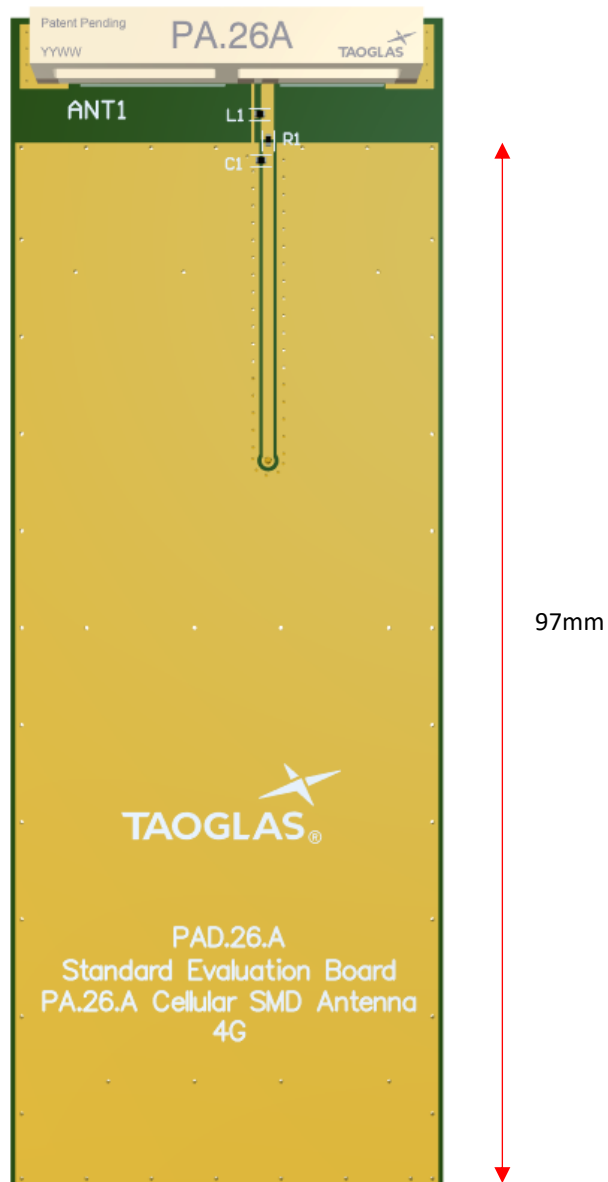

6. Antenna Integration Guide

6.1 Integration Guide

Whatever the size of the PCB, the antenna should ideally be placed on the PCB's shortest side, to take advantage of the ground plane. Optimized matching components can be placed as shown.

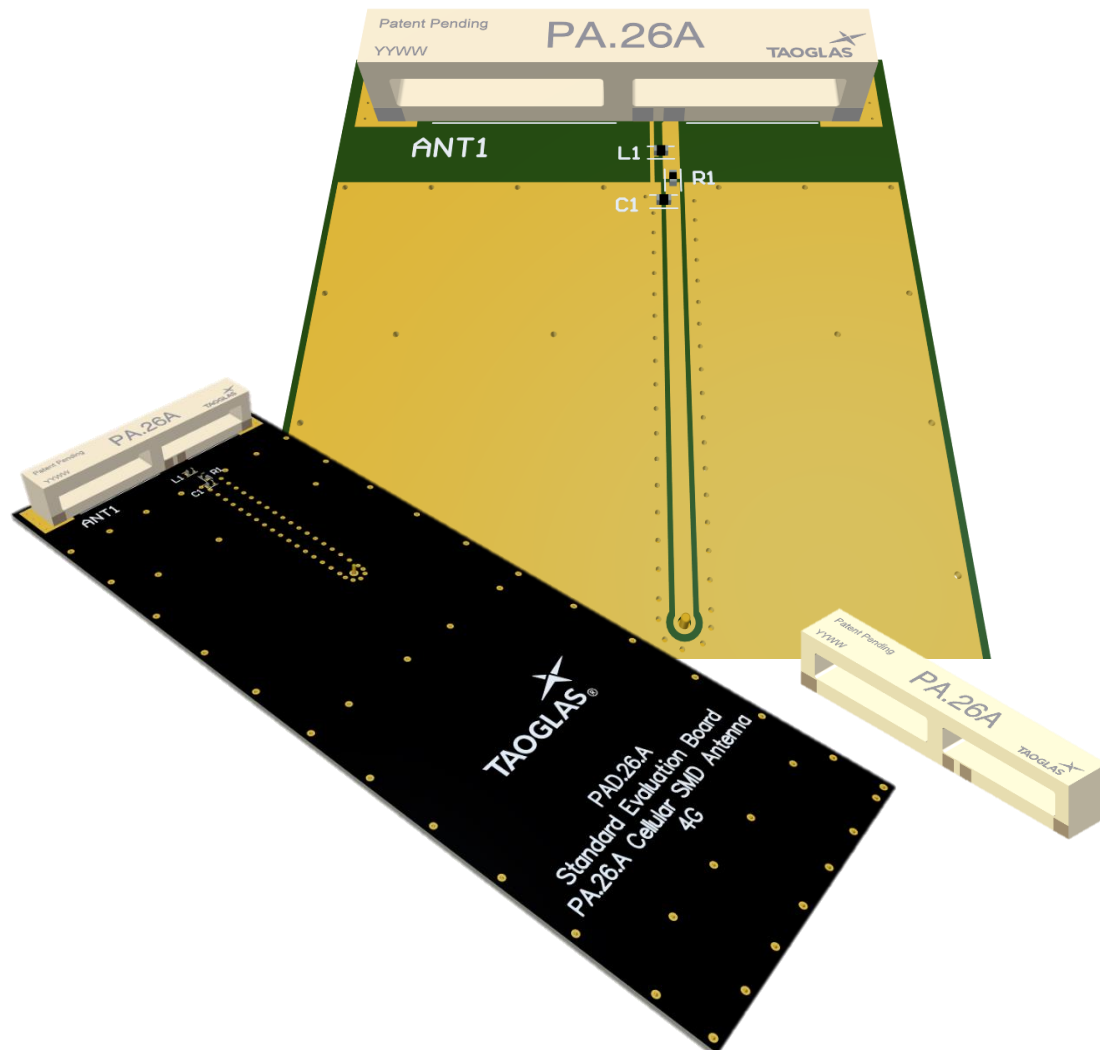

6.2 PCB Layout

The footprint and clearance on the PCB must meet the antenna specification. An example of the PCB layout shows the antenna footprint with clearance. Note the placement of the optimized components. L1 is positioned outside the ground plane and R1 is sitting across the ground plane and the copper clearance area. C1 is optional as a component but it is recommended to include these pads in case they are needed.

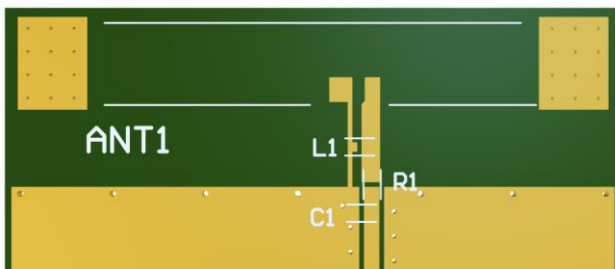

Topside

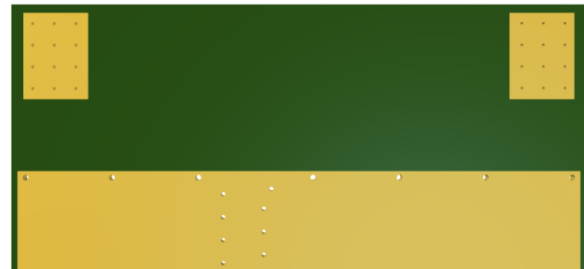

Bottom Side

6.3 PCB Clearance

Below shows the antenna footprint and clearance through ALL layers on the PCB. Only the antenna pads and connections to feed and GND are present within this clearance area (marked RED). The clearance area extends to 5mm from the antenna mechanical pads to the ground area. This clearance area includes the bottom side and ALL internal layers on the PCB.

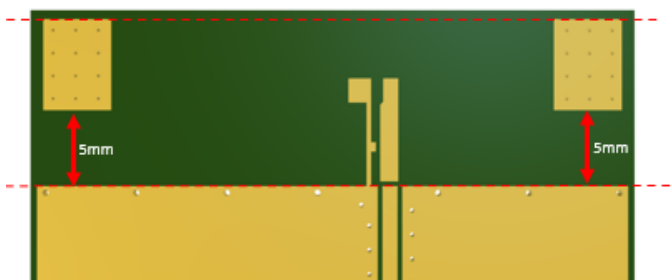

Topside



Bottom Side

6.4 Schematic Symbol and Pin Definitions

The circuit symbol for the antenna is shown below. The antenna has 4 pins with only two pins (Pin 1 and Pin 2) as functional. Pins 3 and 4 are for mechanical strength.

Pin	Description
1	RF Feed
2	Ground
3, 4	Mechanical, Not Connected

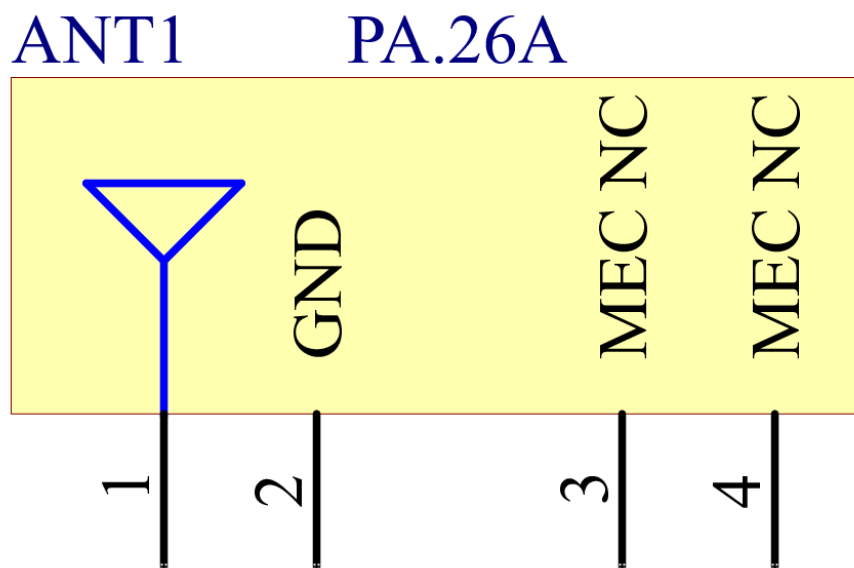

7. Evaluation Board Matching Circuit

A matching component (L1) in parallel with the PA.26A is required for the antenna to have optimal performance on the evaluation board, located outside of the ground plane in the space specified in the above images. Additional matching components may be necessary for your device, so we recommend incorporating extra component footprints, forming a “pi” network, between the cellular module and the edge of the ground plane.

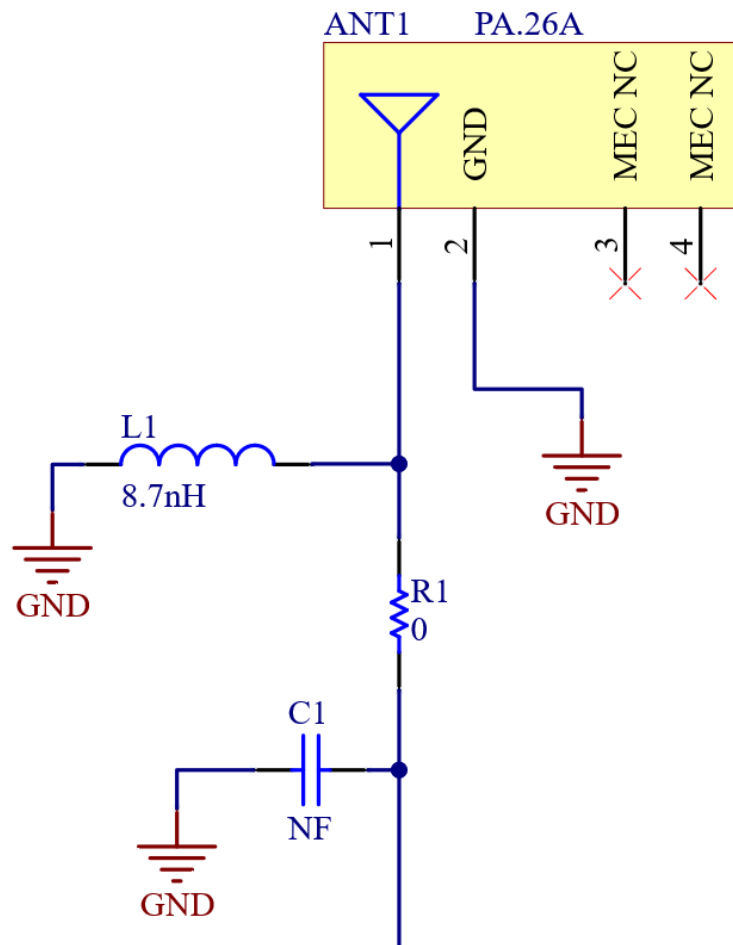

Matching Components

Designator	Type	Value	Description
L1	Inductor	8.7nH	Murata LQG15HS series
R1	Resistor	0 Ohms	Yageo RC0402 series
C1	Capacitor	Not Fitted	

8. Recommended Reflow Temperature Profile

This PA.26.A can be assembled following either Sn-Pb or Pb-Free assembly processes. The recommended soldering temperatures are as follows:

Phase	Profile Features	Sn-Pb Assembly	Pb-Free Assembly (SnAgCu)
Ramp-Up	Avg Ramp-Up Rate (T _{smax} to T _p)	3°C/second (max)	3°C/second (max)
Preheat	Temperature Min (T _{smin}) Temperature Max (T _{smax}) Time (t _{smin} to t _{smax})	100°C 150°C 60-120 seconds	150°C 200°C 60-120 seconds
Reflow	Temperature (T _L) Total Time Above T _L b(t _L)	183°C 60-150 seconds	217°C 60-150 seconds
Peak	Temperature (T _p) Time (t _p)	235°C 10-30 seconds	260°C 20-40 seconds
Ramp-Down	Rate	6°C/second (max)	6°C/second (max)
Time from 25°C to peak Temperature		6 minutes max	8 minutes max

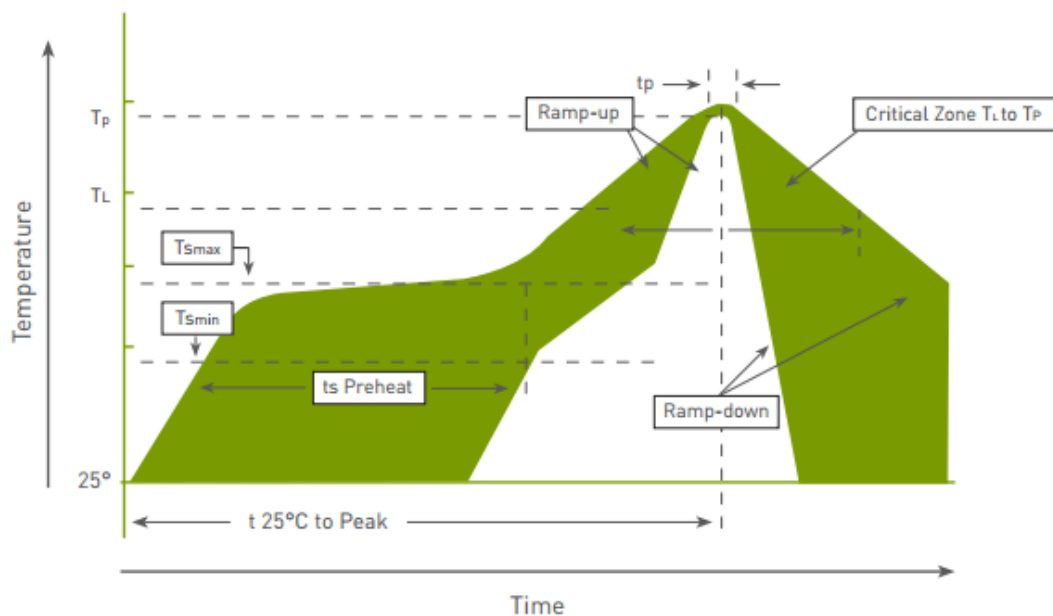

Temperature profile – (green area) for the assembly process in reflow ovens

9. Packaging

450 pc PA.26A
 1 reel per small inner box
 Dimensions - 330*56mm
 Weight - 1.7kg

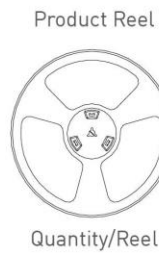

2 Desiccants
 5g (6*4cm)



Humidity indicator
 card (7.5*5cm)

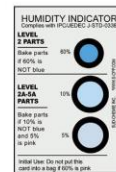

Vacuum packaging

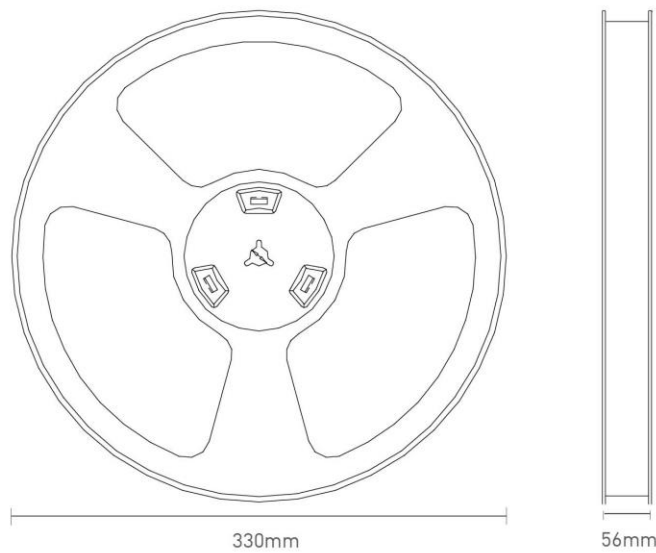

Symbol	Spec
Po	4.0 ± 0.10
P1	12.0 ± 0.10
P2	2.0 ± 0.15
Do	1.5
D1	2.0 (Min)
F	20.2 ± 0.10
So	40.4 ± 0.10
W	44.0 ± 0.30

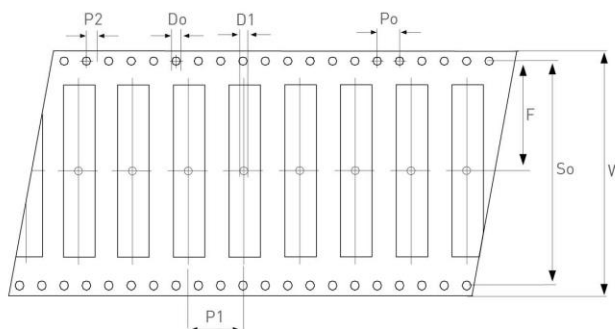

450 pc PA.26A
1 reel in small inner box
Dimensions - 350*340*67
Weight - 1.9Kg

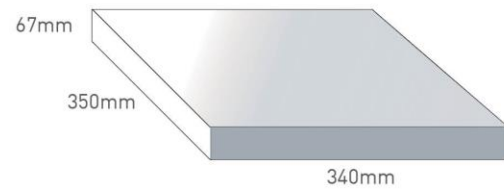

3 boxes / 1350 pcs in one carton
Carton Dimensions - 370*360*275mm
Weight - 6.8Kg

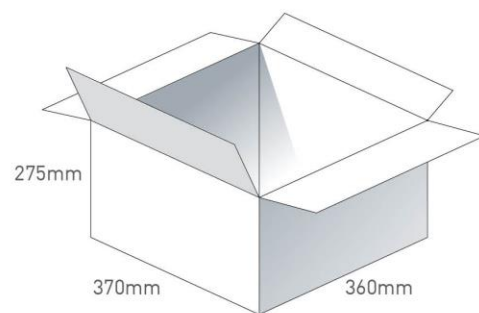

Pallet Dimensions 1110*720*1270mm
24 Cartons per Pallet
6 Cartons per layer
4 Layers

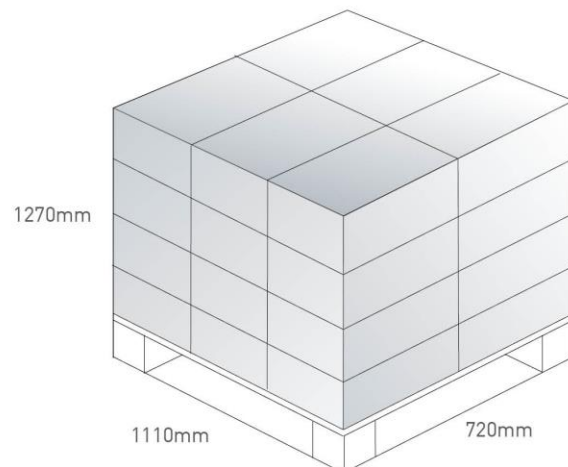

10. Application Note

10.1 Return Loss

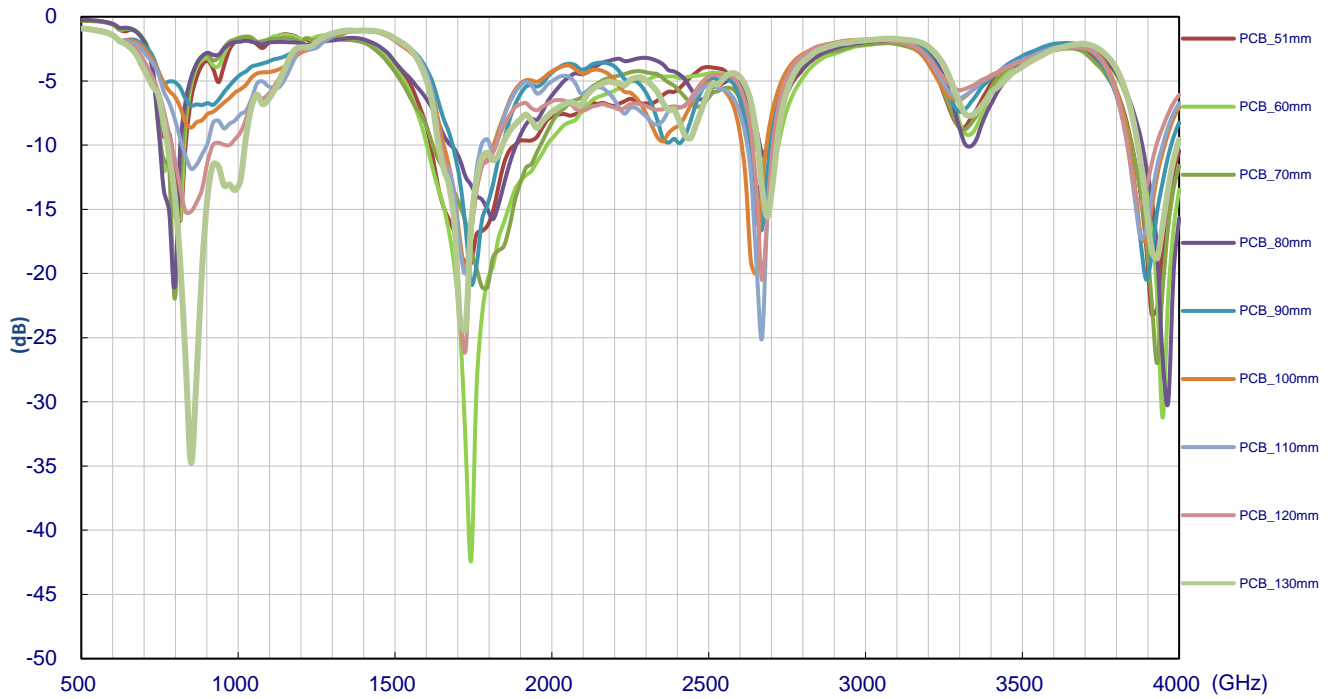

10.2 Efficiency

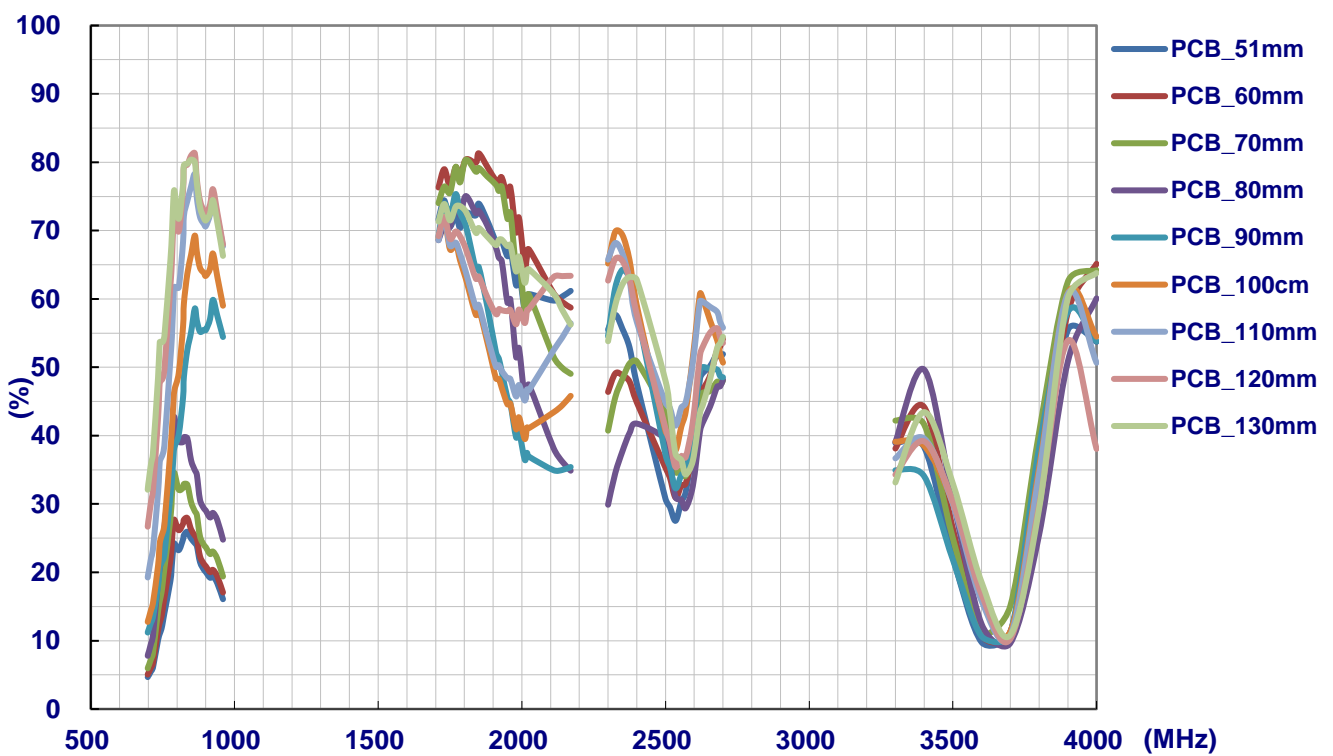

10.3 Average Gain

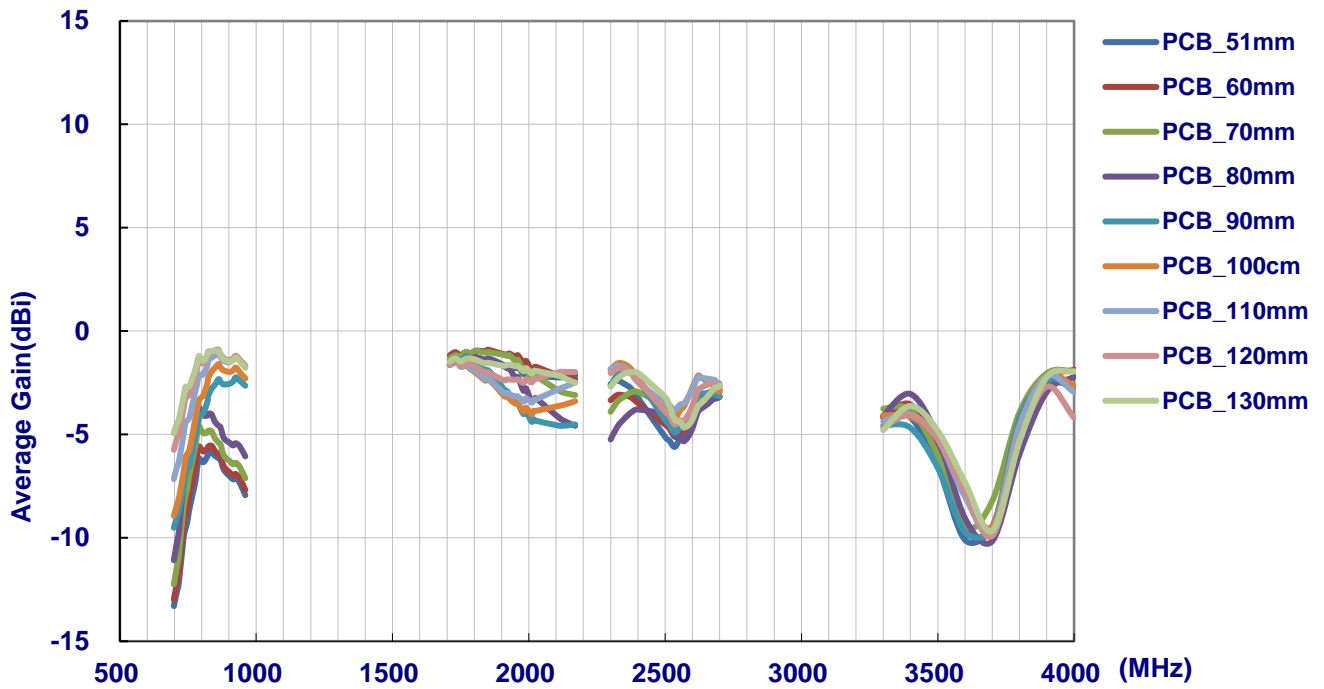

10.4 Peak Gain

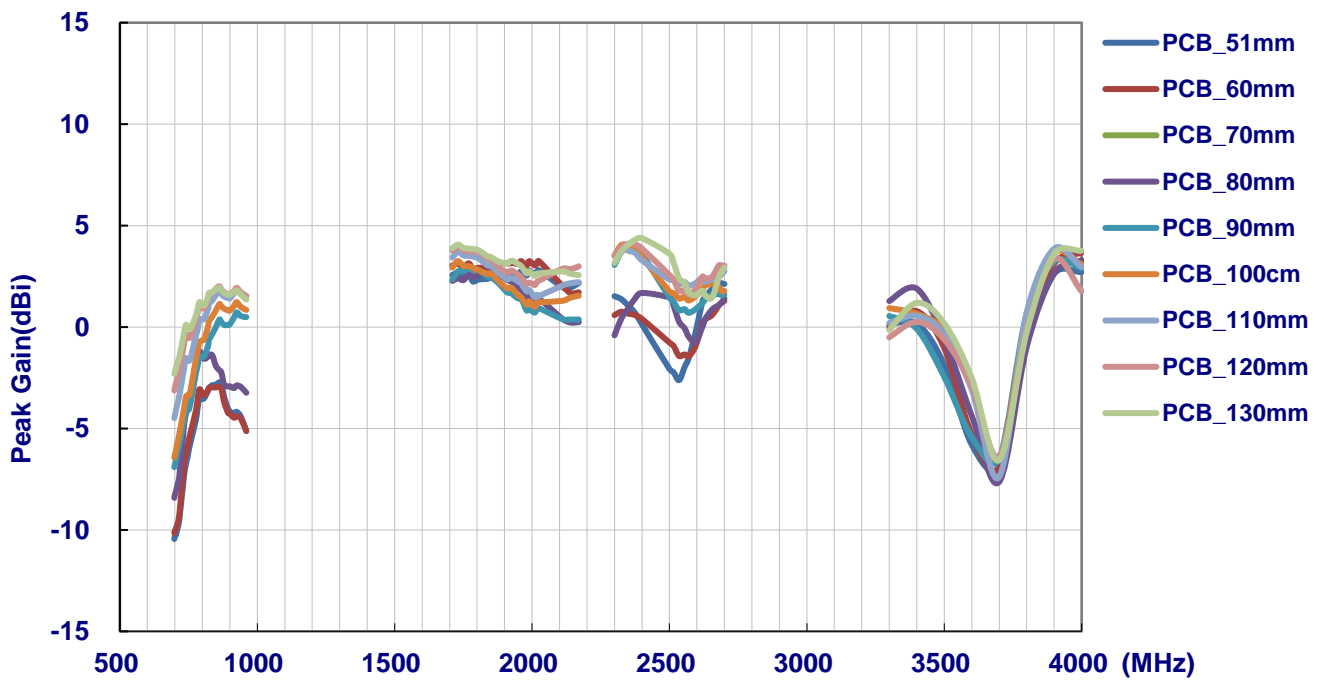

Changelog for the datasheet

SPE-16-8-062 – PA.26.A

Revision: F (Current Version)

Date:	2020-05-11
Changes:	Specifications table amended
Changes Made by:	Dan Cantwell

Previous Revisions

Revision: E

Date:	2018-03-27
Changes:	Template, drawings and data amended
Changes Made by:	Jack Conroy

Revision: D

Date:	2019-03-27
Changes:	Drawings amended
Changes Made by:	Jack Conroy

Revision: C

Date:	2017-03-08
Changes:	Packaging Details Updated
Changes Made by:	Andy Mahoney

Revision: B

Date:	2016-12-21
Changes:	Packaging Details Updated
Changes Made by:	Andy Mahoney

Revision: A (Original First Release)

Date:	2016-09-21
Notes:	
Author:	Wayne Yang



TAOGLAS®

www.taoglas.com

