

# Optocoupler, Phototransistor Output, With Base Connection in SOIC-8 Package, 110 °C Rated

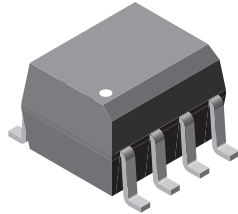

I179074

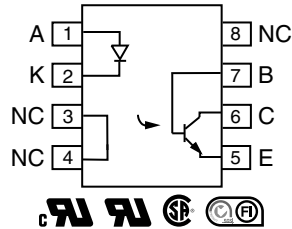

## LINKS TO ADDITIONAL RESOURCES



## DESCRIPTION

The 110 °C 1206AT, 1207AT, 1208AT are optically coupled pairs with a gallium arsenide infrared LED and a silicon NPN phototransistor. Signal information, including a DC level, can be transmitted by the device while maintaining a high degree of electrical isolation between input and output. This family comes in a standard SOIC-8 small outline package for surface mounting which makes them ideally suited for high density application with limited space. In addition to eliminating through-hole requirements, this package conforms to standards for surface mounted devices.

A specified minimum and maximum CTR allows a narrow tolerance in the electrical design of the adjacent circuits. The high  $BV_{CEO}$  of 70 V gives a higher safety margin compared to the industry standard 30 V.

## FEATURES

- Operating temperature from -55 °C to +110 °C
- High  $BV_{CEO}$ , 70 V
- Isolation test voltage, 4000  $V_{RMS}$
- Industry standard SOIC-8 surface mountable package
- Compatible with dual wave, vapor phase and IR reflow soldering
- Lead (Pb)-free component
- Material categorization: for definitions of compliance please see [www.vishay.com/doc?99912](http://www.vishay.com/doc?99912)

**RoHS**  
COMPLIANT

## APPLICATIONS

- AC adapters
- PLCs
- Switch mode power supplies
- DC/DC converters
- Microprocessor I/O interfaces
- General impedance matching circuits

## AGENCY APPROVALS

- [UL1577](#) - file no. E52744 system code Y
- [cUL](#) - file no. E52744
- [DIN EN 60747-5-5 \(VDE 0884\)](#) available with option 1
- [CSA 93751](#)
- [FIMKO](#)

ORDERING INFORMATION			
<div style="display: flex; justify-content: space-around; align-items: center;"> <div style="border: 1px solid black; padding: 2px 5px;">I</div> <div style="border: 1px solid black; padding: 2px 5px;">L</div> <div style="border: 1px solid black; padding: 2px 5px;">1</div> <div style="border: 1px solid black; padding: 2px 5px;">2</div> <div style="border: 1px solid black; padding: 2px 5px;">0</div> <div style="border: 1px solid black; padding: 2px 5px;">6</div> <div style="border: 1px solid black; padding: 2px 5px;">A</div> <div style="border: 1px solid black; padding: 2px 5px;">T</div> </div> <p style="text-align: center;">PART NUMBER</p>	<p>TAPE AND REEL</p>		
AGENCY CERTIFIED / PACKAGE	CTR (%)		
	1 mA		
<b>UL, cUL, CSA, FIMKO</b>	<b>63 to 125</b>	<b>100 to 200</b>	<b>160 to 320</b>
SOIC-8	IL1206AT	IL1207AT	IL1208AT

### Note

- Additional options may be possible, please contact sales office



ABSOLUTE MAXIMUM RATINGS (T <sub>amb</sub> = 25 °C, unless otherwise specified)				
PARAMETER	TEST CONDITION	SYMBOL	VALUE	UNIT
<b>INPUT</b>				
Continuous forward current		I <sub>F</sub>	60	mA
Peak reverse voltage		V <sub>R</sub>	6.0	V
Power dissipation		P <sub>diss</sub>	90	mW
Derate linearly from 25 °C			0.9	mW/°C
<b>OUTPUT</b>				
Collector emitter voltage		V <sub>CE</sub>	70	V
Collector current		I <sub>C</sub>	50	mA
	t < 1.0 ms	I <sub>C</sub>	100	mA
Power dissipation		P <sub>diss</sub>	150	mW
Derate linearly from 25 °C			1.5	mW/°C
<b>COUPLER</b>				
Isolation test voltage		V <sub>ISO</sub>	4000	V <sub>RMS</sub>
Operating temperature		T <sub>amb</sub>	-55 to +110	°C
Total package dissipation (LED and detector)		P <sub>tot</sub>	240	mW
Storage temperature		T <sub>stg</sub>	-55 to +150	°C
Soldering temperature <sup>(1)</sup>	Max. 10 s, dip soldering distance to seating plane <sup>3</sup> 1.5 mm	T <sub>slid</sub>	260	°C
Derate linearly from 25 °C			2.4	mW/°C

**Notes**

- Stresses in excess of the absolute maximum ratings can cause permanent damage to the device. Functional operation of the device is not implied at these or any other conditions in excess of those given in the operational sections of this document. Exposure to absolute maximum ratings for extended periods of the time can adversely affect reliability

<sup>(1)</sup> Refer to reflow profile for soldering conditions for surface mounted devices (SOP / SOIC)

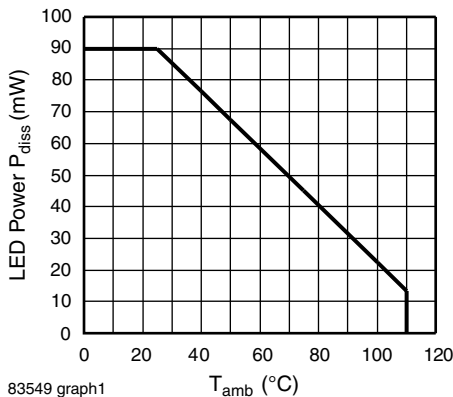

Fig. 1 - Input Power Dissipation (LED) vs. Ambient Temperature

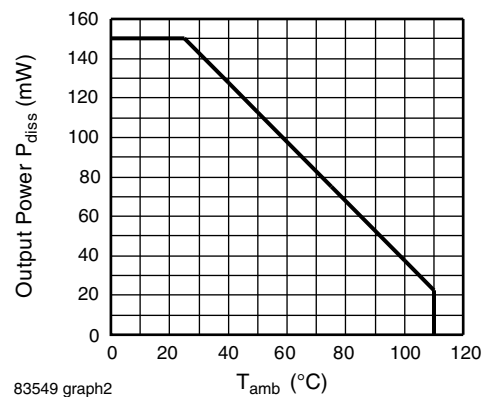

Fig. 2 - Output Power Dissipation vs. Ambient Temperature

<b>ELECTRICAL CHARACTERISTICS</b> ( $T_{amb} = 25\text{ }^{\circ}\text{C}$ , unless otherwise specified)							
PARAMETER	TEST CONDITION	PART	SYMBOL	MIN.	TYP.	MAX.	UNIT
<b>INPUT</b>							
Forward voltage	$I_F = 10\text{ mA}$		$V_F$	-	1.3	1.5	V
Reverse current	$V_R = 6\text{ V}$		$I_R$	-	0.1	100	$\mu\text{A}$
Capacitance	$V_R = 0\text{ V}$		$C_I$	-	13	-	pF
<b>OUTPUT</b>							
Collector emitter leakage current	$V_{CE} = 10\text{ V}$		$I_{CEO}$	-	5.0	50	nA
Collector emitter breakdown voltage	$I_C = 100\text{ }\mu\text{A}$		$BV_{CEO}$	70	-	-	V
Emitter collector breakdown voltage	$I_E = 100\text{ }\mu\text{A}$		$BV_{ECO}$	7.0	10	-	V
Collector base breakdown current			$BV_{CBO}$	70	-	-	V
Saturation voltage, collector emitter	$I_C = 2\text{ mA}, I_F = 10\text{ mA}$		$V_{CEsat}$	-	-	0.4	V
<b>COUPLER</b>							
DC current transfer ratio	$I_F = 10\text{ mA}, V_{CE} = 5.0\text{ V}$	IL1206AT	CTR	63	-	125	%
		IL1207AT	CTR	100	-	200	%
		IL1208AT	CTR	100	-	320	%
	$I_F = 1.0\text{ mA}, V_{CE} = 5.0\text{ V}$	IL1206AT	CTR	22	40	-	%
		IL1207AT	CTR	34	60	-	%
		IL1208AT	CTR	56	95	-	%
Capacitance (input to output)			$C_{IO}$	-	0.5	-	pF

**Note**

- Minimum and maximum values were tested requirements. Typical values are characteristics of the device and are the result of engineering evaluations. Typical values are for information only and are not part of the testing requirements

<b>SWITCHING CHARACTERISTICS</b>							
PARAMETER	TEST CONDITION	SYMBOL	MIN.	TYP.	MAX.	UNIT	
Turn-on time	$I_C = 2\text{ mA}, R_L = 100\text{ }\Omega, V_{CC} = 10\text{ V}$	$t_{on}$	-	3.0	-	$\mu\text{s}$	
Turn-off time	$I_C = 2\text{ mA}, R_L = 100\text{ }\Omega, V_{CC} = 10\text{ V}$	$t_{off}$	-	3.0	-	$\mu\text{s}$	

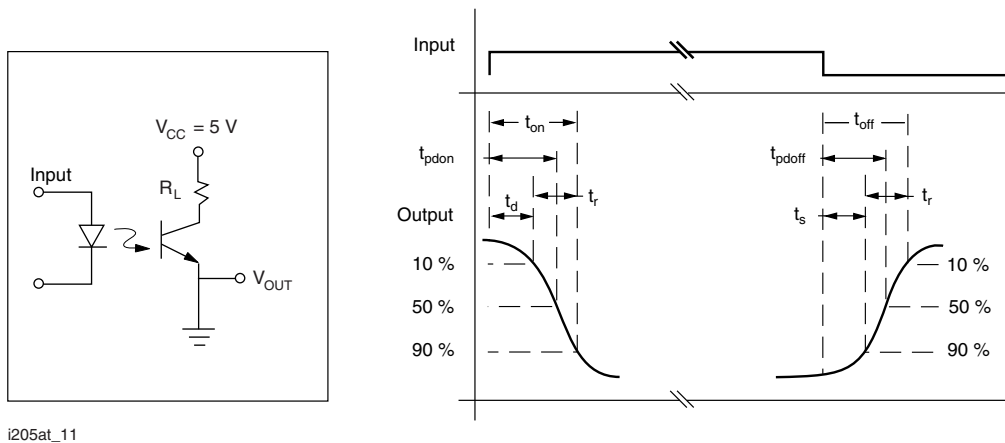

Fig. 1 - Switching Test Circuit

SAFETY AND INSULATION RATINGS						
PARAMETER	TEST CONDITION	SYMBOL	MIN.	TYP.	MAX.	UNIT
Climatic classification	According to IEC 68 part 1		-	55 / 110 / 21	-	
Pollution degree (DIN VDE 0109)			-	2.0	-	
Comparative tracking index		CTI	175	-	399	
$V_{IOTM}$	DIN IEC 112 / VDE 0303 part 1, group IIIa per DIN VDE 6110 175 399	$V_{IOTM}$	6000	-	-	V
$V_{IORM}$		$V_{IORM}$	560	-	-	V
Resistance (input to output)		$R_{IO}$	-	$10^{12}$	-	$\Omega$
$P_{SI}$			-	-	350	mW
$I_{SI}$			-	-	150	mA
$T_{SI}$			-	-	165	$^{\circ}C$
Creepage distance			4.0	-	-	mm
Clearance distance			4.0	-	-	mm

**Note**

- As per IEC 60747-5-2, §7.4.3.8.1, this optocoupler is suitable for “safe electrical insulation” only within the safety ratings. Compliance with the safety ratings shall be ensured by means of protective circuits

**TYPICAL CHARACTERISTICS** ( $T_{amb} = 25^{\circ}C$ , unless otherwise specified)

 Fig. 2 - Diode Forward Voltage  $V_F$  vs. Forward Current

Fig. 4 - Collector to Emitter Current vs. Ambient Temperature

 Fig. 3 -  $I_C$  (non-saturated) vs.  $V_{CE}$ 

 Fig. 5 -  $I_C$  (saturated) vs.  $V_{CE}$

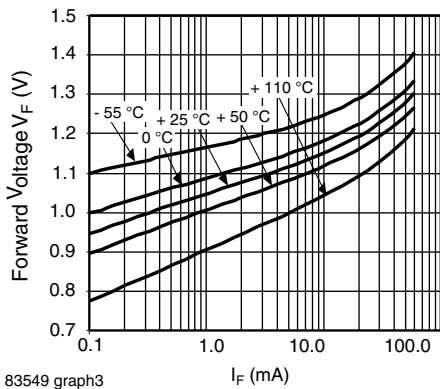
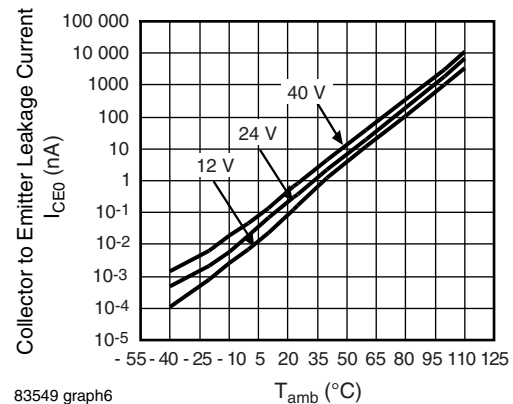
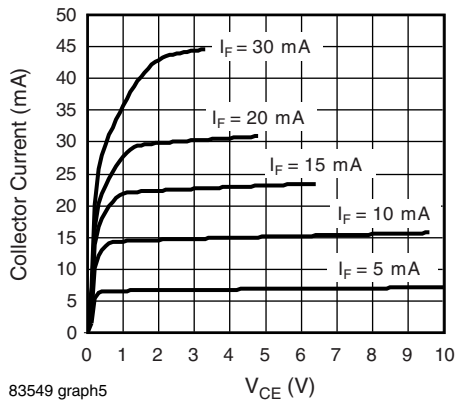
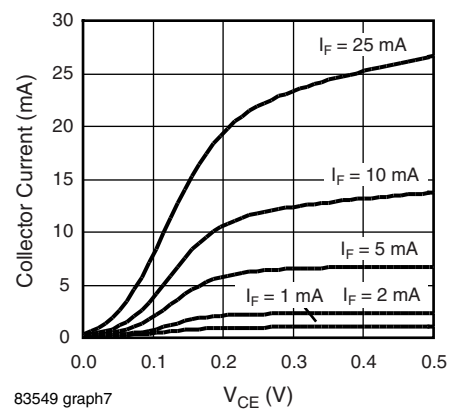
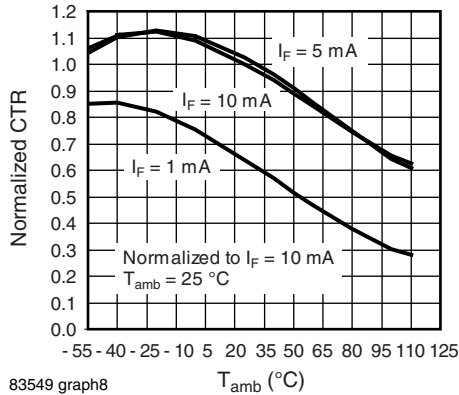

Fig. 6 - CTR Normalized to  $I_F = 10$  mA vs. Ambient Temperature, (Saturated,  $V_{CE} = 0.4$  V)

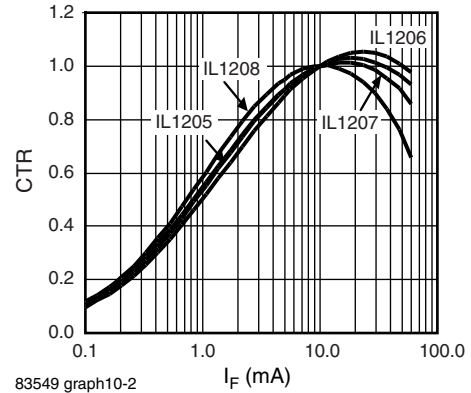

Fig. 9 - CTR vs.  $I_F$ , ( $V_{CE} = 5$  V,  $T_{amb} = 25$  °C) Normalized to  $I_F = 10$  mA,  $T_{amb} = 25$  °C

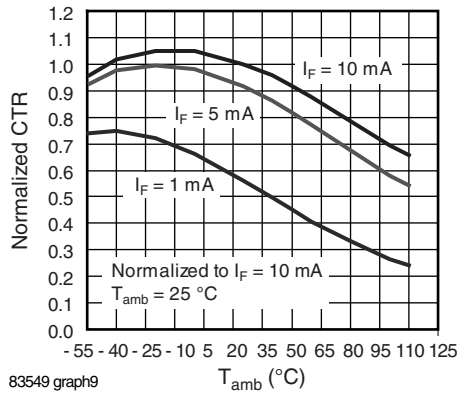

Fig. 7 - CTR Normalized to  $I_F = 10$  mA vs. Ambient Temperature, (Non-Saturated,  $V_{CE} = 5$  V)

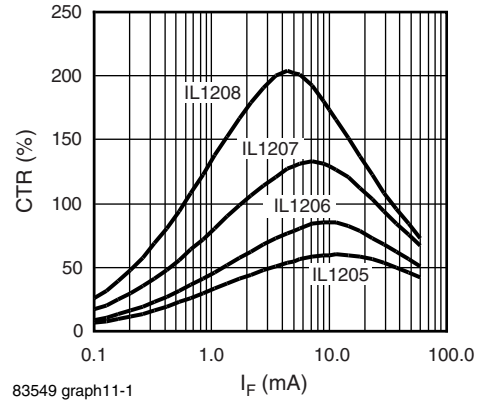

Fig. 10 - CTR vs.  $I_F$  Saturated, ( $V_{CE} = 0.4$  V,  $T_{amb} = 25$  °C)

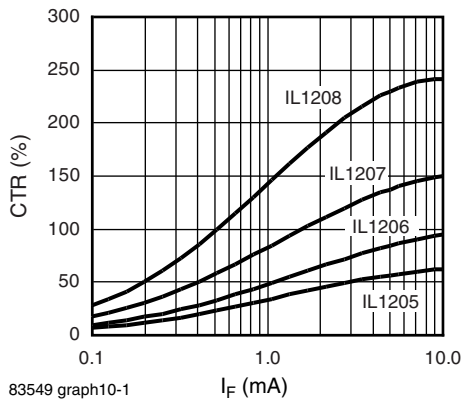

Fig. 8 - CTR vs.  $I_F$ , ( $V_{CE} = 5$  V,  $T_{amb} = 25$  °C) (Not Normalized)

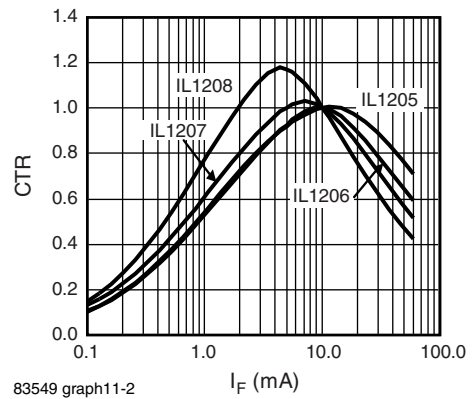

Fig. 11 - CTR vs.  $I_F$  Saturated, Normalized to  $I_F = 10$  mA,  $T_{amb} = 25$  °C

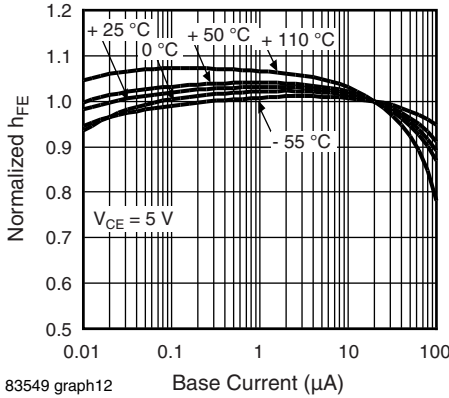

Fig. 12 - Normalized  $h_{FE}$  vs. Base Current and  $T_{amb}$  (Non-Saturated Condition)

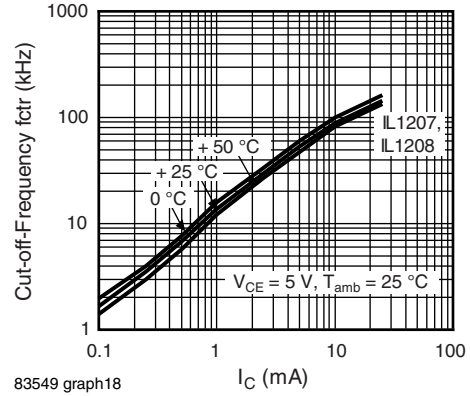

Fig. 15 - Cut-Off-Frequency (- 3 dB) vs. Collector Current

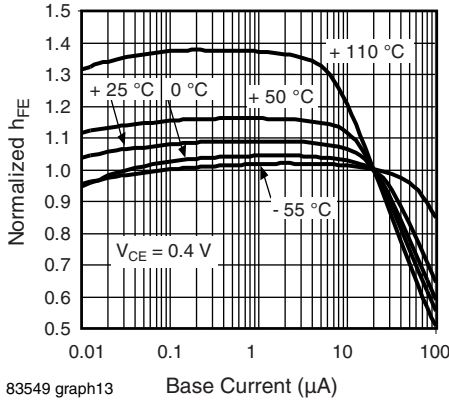

Fig. 13 - Normalized  $h_{FE}$  vs. Base Current and  $T_{amb}$  (Saturated Condition)

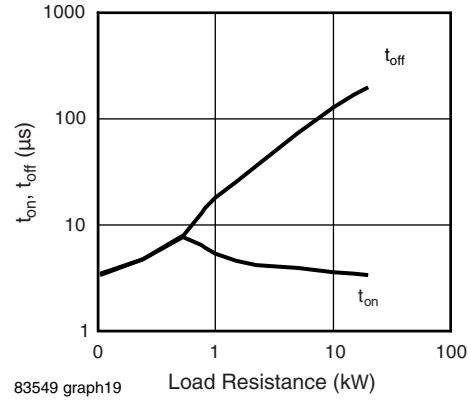

Fig. 16 - Switching Time  $t_{on}$ ,  $t_{off}$  vs. Load Resistance

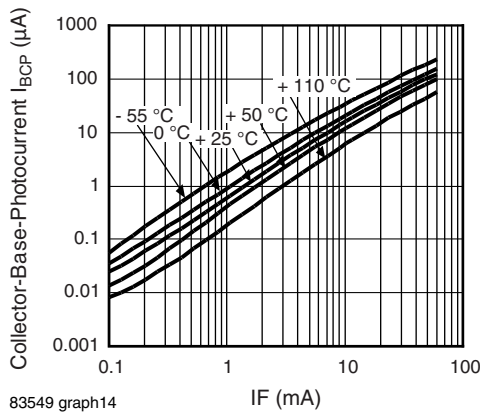

Fig. 14 - Collector Base Photocurrent vs.  $I_F$

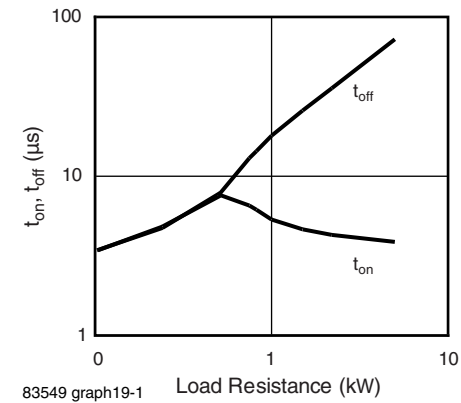

Fig. 17 - Switching Time  $t_{on}$ ,  $t_{off}$  vs. Load Resistance (100  $\Omega$  to 5000  $\Omega$ )

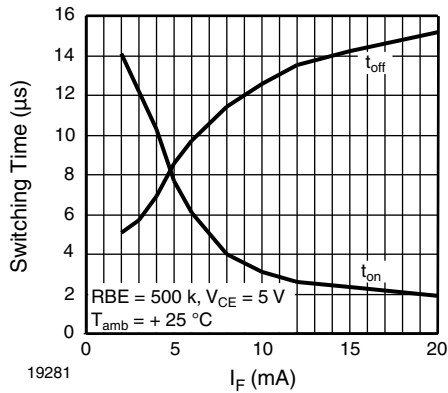

Fig. 18 - Switching Time vs.  $I_F$

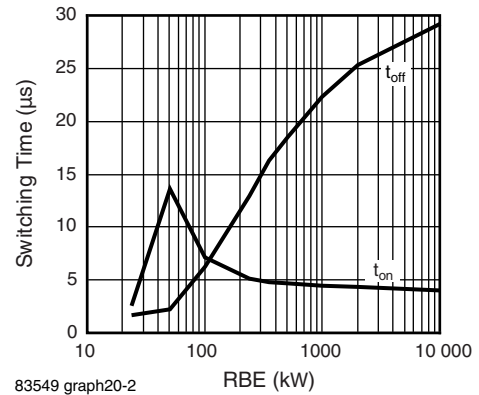
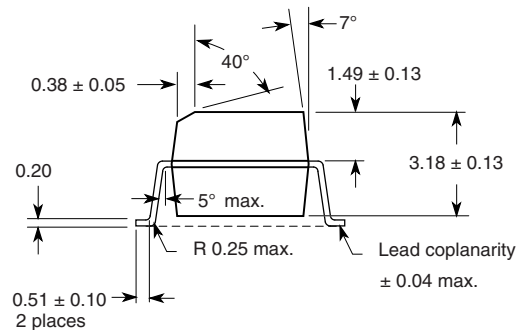
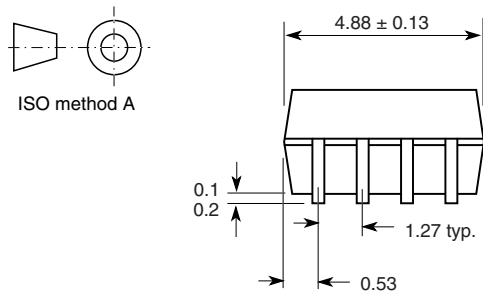
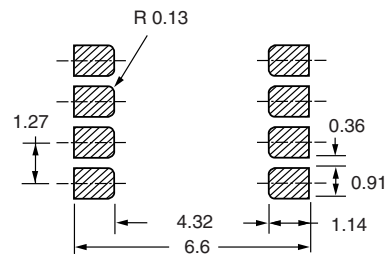
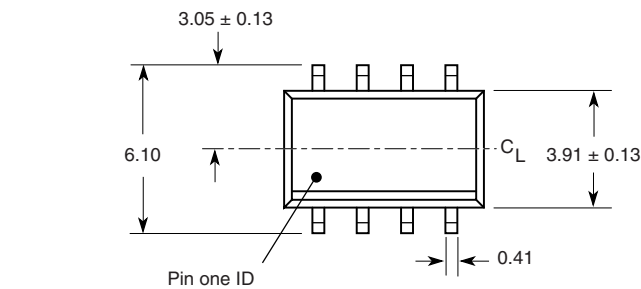

Fig. 19 - Switching Time vs. RBE,  $I_F = 10$  mA

**PACKAGE DIMENSIONS** in millimeters



i178003



## **Disclaimer**

ALL PRODUCT, PRODUCT SPECIFICATIONS AND DATA ARE SUBJECT TO CHANGE WITHOUT NOTICE TO IMPROVE RELIABILITY, FUNCTION OR DESIGN OR OTHERWISE.

Vishay Intertechnology, Inc., its affiliates, agents, and employees, and all persons acting on its or their behalf (collectively, "Vishay"), disclaim any and all liability for any errors, inaccuracies or incompleteness contained in any datasheet or in any other disclosure relating to any product.

Vishay makes no warranty, representation or guarantee regarding the suitability of the products for any particular purpose or the continuing production of any product. To the maximum extent permitted by applicable law, Vishay disclaims (i) any and all liability arising out of the application or use of any product, (ii) any and all liability, including without limitation special, consequential or incidental damages, and (iii) any and all implied warranties, including warranties of fitness for particular purpose, non-infringement and merchantability.

Statements regarding the suitability of products for certain types of applications are based on Vishay's knowledge of typical requirements that are often placed on Vishay products in generic applications. Such statements are not binding statements about the suitability of products for a particular application. It is the customer's responsibility to validate that a particular product with the properties described in the product specification is suitable for use in a particular application. Parameters provided in datasheets and / or specifications may vary in different applications and performance may vary over time. All operating parameters, including typical parameters, must be validated for each customer application by the customer's technical experts. Product specifications do not expand or otherwise modify Vishay's terms and conditions of purchase, including but not limited to the warranty expressed therein.

Hyperlinks included in this datasheet may direct users to third-party websites. These links are provided as a convenience and for informational purposes only. Inclusion of these hyperlinks does not constitute an endorsement or an approval by Vishay of any of the products, services or opinions of the corporation, organization or individual associated with the third-party website. Vishay disclaims any and all liability and bears no responsibility for the accuracy, legality or content of the third-party website or for that of subsequent links.

Except as expressly indicated in writing, Vishay products are not designed for use in medical, life-saving, or life-sustaining applications or for any other application in which the failure of the Vishay product could result in personal injury or death. Customers using or selling Vishay products not expressly indicated for use in such applications do so at their own risk. Please contact authorized Vishay personnel to obtain written terms and conditions regarding products designed for such applications.

No license, express or implied, by estoppel or otherwise, to any intellectual property rights is granted by this document or by any conduct of Vishay. Product names and markings noted herein may be trademarks of their respective owners.