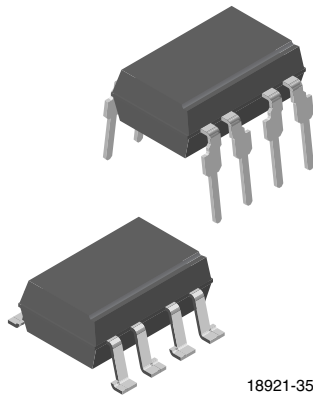
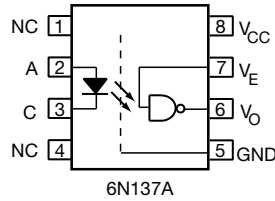


High Speed Optocoupler, 10 MBd



18921-35



Truth Table (Positive Logic)

LED	ENABLE	OUTPUT
ON	H	L
OFF	H	H
ON	L	H
OFF	L	H
ON	NC	L
OFF	NC	H

FEATURES

- CMR performance of 1 kV/μs
- High speed: 10 MBd typical
- LSTTL/TTL compatibility
- Low input current capability: 5 mA
- Material categorization:
For definitions of compliance please see www.vishay.com/doc?99912



RoHS COMPLIANT

APPLICATIONS

- Microprocessor system interface
- PLC, ATE input/output isolation
- Computer peripheral interface
- Digital fieldbus isolation: CC-link, DeviceNet, profibus, SDS
- High speed A/D and D/A conversion
- AC plasma display panel level shifting
- Multiplexed data transmission
- Digital control power supply
- Ground loop elimination

DESCRIPTION

The 6N137A is single channel 10 MBd optocouplers utilizing a high efficient input LED coupled to a very high speed integrated photo-detector logic gate with a strobable output. This detector features an open collector. The internal shield provides a guaranteed common mode transient immunity of 1 kV/μs. The use of a 0.1 μF bypass capacitor connected between pin 5 and 8 is recommended.

AGENCY APPROVALS

(Parts are certified under base model 6N137A)

- UL1577 file number: E52744, double protection
- cUL tested to CSA 22.2 bulletin 5A
- DIN EN 60747-5-5 (VDE 0884-5), available with option 1
- CQC GB8898, GB4943.1

ORDERING INFORMATION	
<div style="display: flex; justify-content: space-around; align-items: center;"> <div style="text-align: center;"> <div style="border: 1px solid black; padding: 2px 5px;">6</div> <div style="border: 1px solid black; padding: 2px 5px;">N</div> <div style="border: 1px solid black; padding: 2px 5px;">1</div> <div style="border: 1px solid black; padding: 2px 5px;">3</div> <div style="border: 1px solid black; padding: 2px 5px;">7</div> <div style="border: 1px solid black; padding: 2px 5px;">A</div> <div style="border: 1px solid black; padding: 2px 5px;">-</div> <div style="border: 1px solid black; padding: 2px 5px;">X</div> <div style="border: 1px solid black; padding: 2px 5px;">0</div> <div style="border: 1px solid black; padding: 2px 5px;">0</div> <div style="border: 1px solid black; padding: 2px 5px;">#</div> <div style="border: 1px solid black; padding: 2px 5px;">T</div> </div> <div style="margin-left: 20px;"> <p>DIP-8 Option 7</p> </div> </div>	<p>PART NUMBER PACKAGE OPTION TAPE AND REEL</p>
AGENCY CERTIFIED/PACKAGE	CMR (V/μs)
UL, cUL, CQC	1000
DIP-8	6N137A
SMD-8, option 7	6N137A-X007T
VDE, UL, cUL, CQC	1000
DIP-8	6N137A-X001
SMD-8, option 7	6N137A-X017T

Note

- Additional options may be possible, please contact sales office.



ABSOLUTE MAXIMUM RATINGS ($T_{amb} = 25\text{ }^{\circ}\text{C}$, unless otherwise specified)				
PARAMETER	TEST CONDITION	SYMBOL	VALUE	UNIT
INPUT				
Average forward current		I_F	20	mA
Reverse input voltage		V_R	5	V
Enable input voltage		V_E	$V_{CC} + 0.5\text{ V}$	V
Enable input current		I_E	5	mA
Output power dissipation		P_{diss}	35	mW
OUTPUT				
Supply voltage	1 min maximum	V_{CC}	7	V
Output current		I_O	50	mA
Output voltage		V_O	7	V
Output power dissipation		P_{diss}	85	mW
COUPLER				
Isolation test voltage	$t = 1\text{ min}$	V_{ISO}	5000	V_{RMS}
Storage temperature		T_{stg}	- 55 to + 125	$^{\circ}\text{C}$
Operating temperature		T_{amb}	- 40 to + 85	$^{\circ}\text{C}$
Solder reflow temperature ⁽¹⁾	5 s		260	$^{\circ}\text{C}$

Notes

- Stresses in excess of the absolute maximum ratings can cause permanent damage to the device. Functional operation of the device is not implied at these or any other conditions in excess of those given in the operational sections of this document. Exposure to absolute maximum ratings for extended periods of the time can adversely affect reliability.
- ⁽¹⁾ Refer to reflow profile for soldering conditions for surface mounted devices (SMD). Refer to wave profile for soldering conditions for through hole devices (DIP).

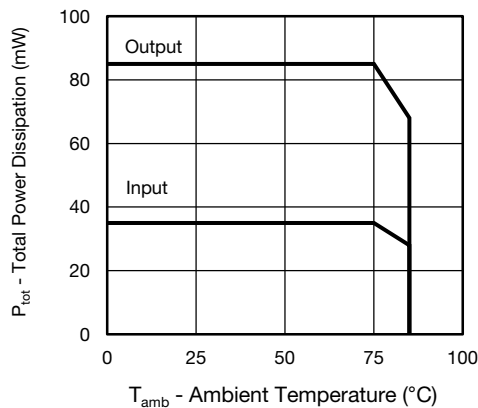


Fig. 1 - Total Power Dissipation vs. Ambient Temperature

RECOMMENDED OPERATING CONDITIONS					
PARAMETER	TEST CONDITION	SYMBOL	MIN.	MAX.	UNIT
Operating temperature		T_{amb}	- 40	85	$^{\circ}\text{C}$
Supply voltage		V_{CC}	4.5	5.5	V
Input current low level		I_{FL}	0	250	μA
Input current high level		I_{FH}	5	15	mA
Logic high enable voltage		V_{EH}	2	V_{CC}	V
Logic low enable voltage		V_{EL}	0	0.8	V
Output pull up resistor		R_L	330	4K	Ω
Fanout	$R_L = 1\text{ k}\Omega$	N		5	-



ELECTRICAL CHARACTERISTICS ($T_{amb} = 25\text{ }^{\circ}\text{C}$, unless otherwise specified)						
PARAMETER	TEST CONDITION	SYMBOL	MIN.	TYP.	MAX.	UNIT
INPUT						
Input forward voltage	$I_F = 10\text{ mA}$	V_F		1.35	1.7	V
Input forward voltage temperature coefficient	$I_F = 10\text{ mA}$	$\Delta V_F/\Delta T$		- 1.2		mV/K
Input reverse voltage	$I_R = 10\text{ }\mu\text{A}$	BV_R	5			V
Input threshold current	$V_E = 2\text{ V}$, $V_{CC} = 5.5\text{ V}$, $I_{OL}(\text{sinking}) = 13\text{ mA}$	I_{TH}		1.8	5	mA
Input capacitance	$f = 1\text{ MHz}$, $V_F = 0\text{ V}$	C_I		28		pF
OUTPUT						
High level supply current	$V_E = 0.5\text{ V}$, $I_F = 0\text{ mA}$	I_{CCH}		8	10	mA
	$V_E = V_{CC}$, $I_F = 10\text{ mA}$			5.8		
Low level supply current	$V_E = 0.5\text{ V}$, $I_F = 0\text{ mA}$	I_{CCL}		10	13	mA
	$V_E = V_{CC}$, $I_F = 10\text{ mA}$			8		
High level enable current	$V_E = 2\text{ V}$	I_{EH}		- 0.6	- 1.6	mA
Low level enable current	$V_E = 0.5\text{ V}$	I_{EL}		- 0.9	- 1.6	mA
High level enable voltage		V_{EH}	2			V
Low level enable voltage		V_{EL}			0.8	V
High level output current	$V_E = 2\text{ V}$, $V_{CC} = 5.5\text{ V}$, $V_O = 5.5\text{ V}$, $I_F = 250\text{ }\mu\text{A}$	I_{OH}		0.02	100	μA
Low level output voltage	$V_E = 2\text{ V}$, $V_{CC} = 5.5\text{ V}$, $I_F = 5\text{ mA}$, $I_{OL}(\text{sinking}) = 13\text{ mA}$	V_{OL}		0.13	0.60	V
Collector emitter capacitance	$f = 1\text{ MHz}$, $T_{amb} = 25\text{ }^{\circ}\text{C}$	C_{IO}		4		pF
COUPLER						
Coupling capacitance	$f = 1\text{ MHz}$, $T_{amb} = 25\text{ }^{\circ}\text{C}$	C_{IO}		0.9		pF

Note

- Minimum and maximum values are testing requirements. Typical values are characteristics of the device and are the result of engineering evaluation. Typical values are for information only and are not part of the testing requirements.

SWITCHING CHARACTERISTICS						
PARAMETER	TEST CONDITION	SYMBOL	MIN.	TYP.	MAX.	UNIT
Propagation delay time to high output level	$R_L = 350\text{ }\Omega$, $C_L = 15\text{ pF}$	t_{PLH}	25	45	75 ⁽¹⁾	ns
Propagation delay time to low output level	$R_L = 350\text{ }\Omega$, $C_L = 15\text{ pF}$	t_{PHL}	25	32	75 ⁽¹⁾	ns
Pulse width distortion	$R_L = 350\text{ }\Omega$, $C_L = 15\text{ pF}$	$ t_{PHL} - t_{PLH} $		13	35	ns
Propagation delay skew	$R_L = 350\text{ }\Omega$, $C_L = 15\text{ pF}$	t_{PSK}		16	40	ns
Output rise time (10 % to 90 %)	$R_L = 350\text{ }\Omega$, $C_L = 15\text{ pF}$	t_r		27		ns
Output fall time (90 % to 10 %)	$R_L = 350\text{ }\Omega$, $C_L = 15\text{ pF}$	t_f		10		ns
Propagation delay time of enable from V_{EH} to V_{EL}	$R_L = 350\text{ }\Omega$, $C_L = 15\text{ pF}$, $V_{EL} = 0\text{ V}$, $V_{EH} = 3\text{ V}$	t_{ELH}		47		ns
Propagation delay time of enable from V_{EL} to V_{EH}	$R_L = 350\text{ }\Omega$, $C_L = 15\text{ pF}$, $V_{EL} = 0\text{ V}$, $V_{EH} = 3\text{ V}$	t_{EHL}		24		ns

Notes

- Over recommended temperature ($T_{amb} = -40\text{ }^{\circ}\text{C}$ to $+85\text{ }^{\circ}\text{C}$), $V_{CC} = 5\text{ V}$, $I_F = 7.5\text{ mA}$, unless otherwise specified. Typical values applies to $V_{CC} = 5\text{ V}$, $T_{amb} = 25\text{ }^{\circ}\text{C}$

(1) A JEDEC registered data for 6N137A

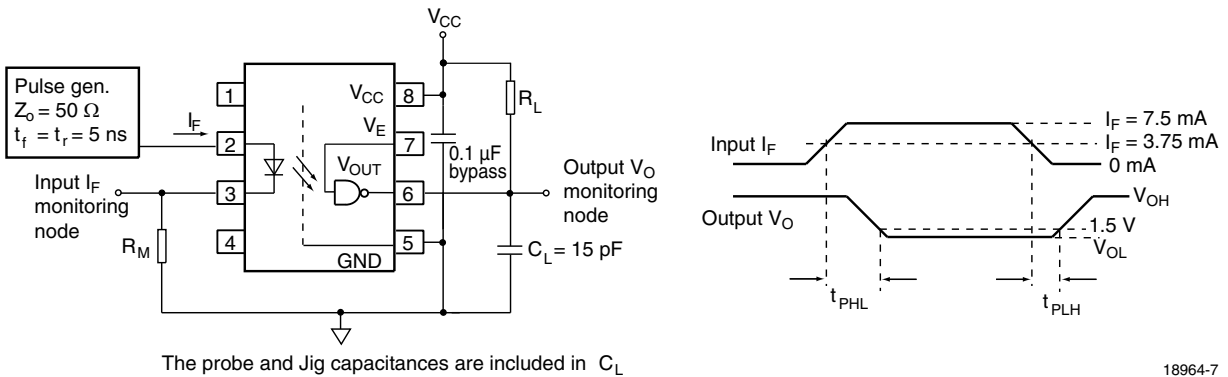


Fig. 2 - Test Circuit for t_{PLH} , t_{PHL} , t_r , and t_f

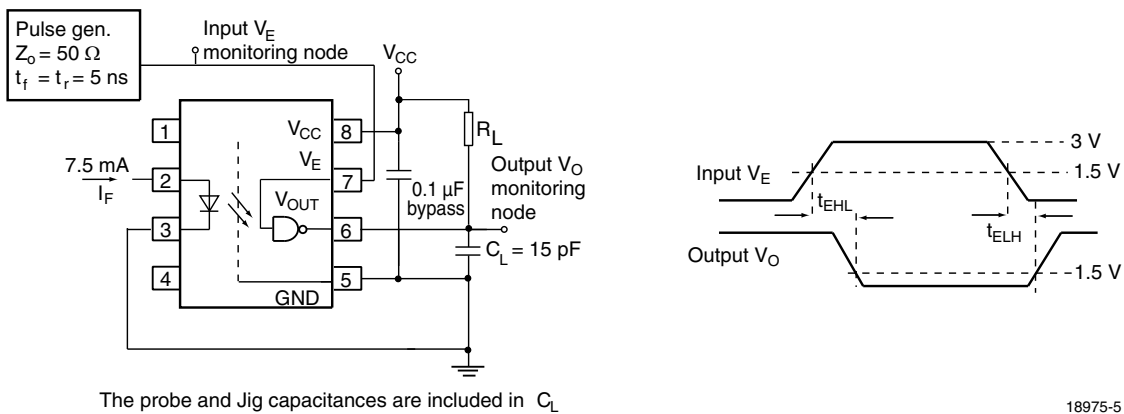


Fig. 3 - Test Circuit for t_{EHL} , and t_{ELH}

COMMON MODE TRANSIENT IMMUNITY						
PARAMETER	TEST CONDITION	SYMBOL	MIN.	TYP.	MAX.	UNIT
Logic high common mode transient immunity ⁽¹⁾⁽³⁾	$ V_{CM} = 50 \text{ V}$, $V_{CC} = 5 \text{ V}$, $I_F = 0 \text{ mA}$, $V_{O(\min.)} = 2 \text{ V}$, $R_L = 350 \Omega$, $T_{amb} = 25 \text{ }^\circ\text{C}$	$ CM_H $	1000			$\text{V}/\mu\text{s}$
Logic low common mode transient immunity ⁽²⁾⁽³⁾	$ V_{CM} = 50 \text{ V}$, $V_{CC} = 5 \text{ V}$, $I_F = 7.5 \text{ mA}$, $V_{O(\min.)} = 0 \text{ V}$, $R_L = 350 \Omega$, $T_{amb} = 25 \text{ }^\circ\text{C}$	$ CM_L $	1000			$\text{V}/\mu\text{s}$

Notes

- (1) CM_H is the maximum tolerable rate of rise of the common mode voltage to assure that the output will remain in a high logic state (i.e. $V_O > 2.0 \text{ V}$)
- (2) CM_L is the maximum tolerable rate of fall of the common mode voltage to assure that the output will remain in a low logic state (i.e. $V_O > 0.8 \text{ V}$)
- (3) No external pull up is required for a high logic state on the enable input. If the enable pin is not used, trying it to V_{CC} .

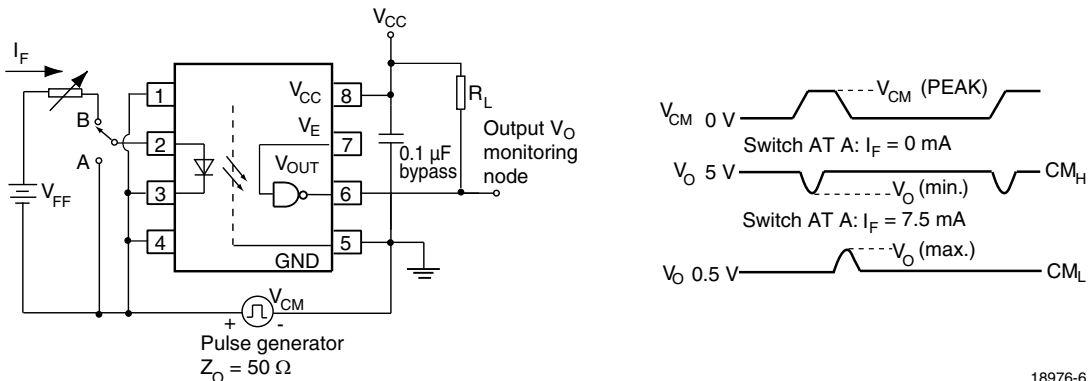


Fig. 4 - Test Circuit for Common Mode Transient Immunity

SAFETY AND INSULATION RATINGS				
PARAMETER		SYMBOL	VALUE	UNIT
MAXIMUM SAFETY RATINGS				
Output safety power		P_{SO}	600	mW
Input safety current		I_{si}	230	mA
Safety temperature		T_S	175	°C
Comparative tracking index		CTI	175	
INSULATION RATED PARAMETERS				
Maximum withstanding isolation voltage		V_{ISO}	5000	V_{RMS}
Maximum transient isolation voltage		V_{IOTM}	6000	V_{peak}
Maximum repetitive peak isolation voltage		V_{IORM}	630	V_{peak}
Insulation resistance	$T_{amb} = 25\text{ °C}, V_{DC} = 500\text{ V}$	R_{IO}	10^{12}	Ω
Isolation resistance	$T_{amb} = 100\text{ °C}, V_{DC} = 500\text{ V}$	R_{IO}	10^{11}	Ω
Climatic classification (according to IEC 68 part 1)			40/85/21	
Environment (pollution degree in accordance to DIN VDE 0109)			2	
Maximum creepage			7	mm
Clearance			7	mm
Insulation thickness			0.4	mm

Note

- As per DIN EN 60747-5-5, §7.4.3.8.2, this optocoupler is suitable for “safe electrical insulation” only within the safety ratings. Compliance with the safety ratings shall be ensured by means of protective circuits.

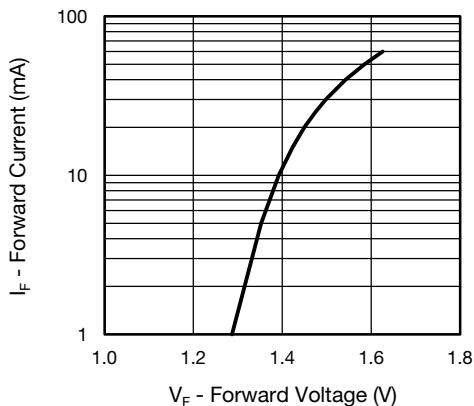
TYPICAL CHARACTERISTICS ($T_{amb} = 25\text{ °C}$, unless otherwise specified)


Fig. 5 - Diode Forward Current vs. Forward Voltage

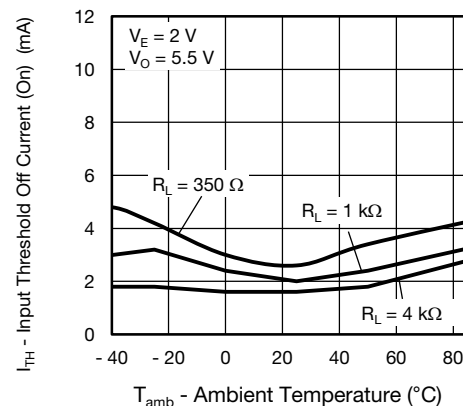


Fig. 7 - Input Threshold Off Current vs. Ambient Temperature

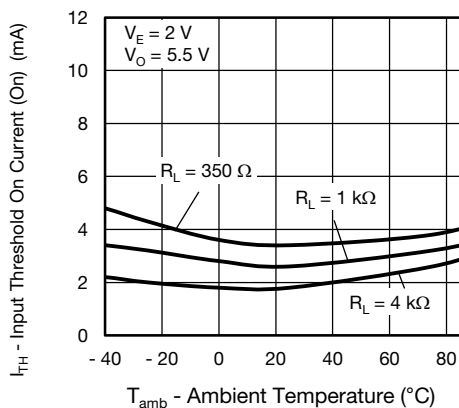


Fig. 6 - Input Threshold On Current vs. Ambient Temperature

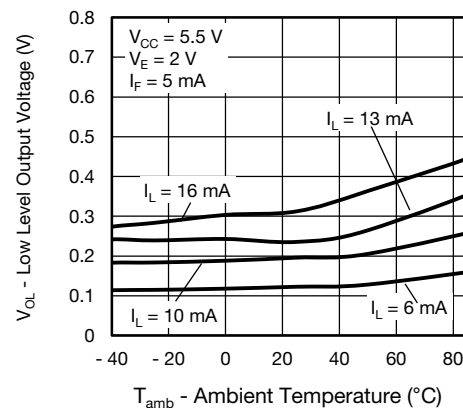


Fig. 8 - Low Level Output Voltage vs. Ambient Temperature

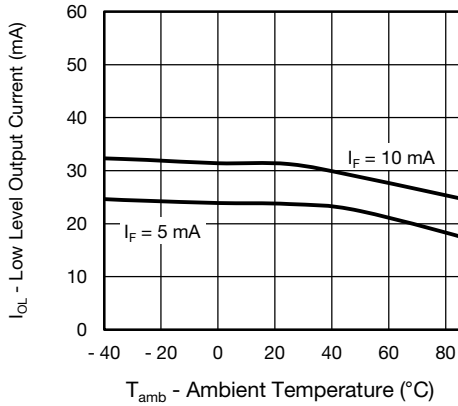


Fig. 9 - Low Level Output Current vs. Ambient Temperature

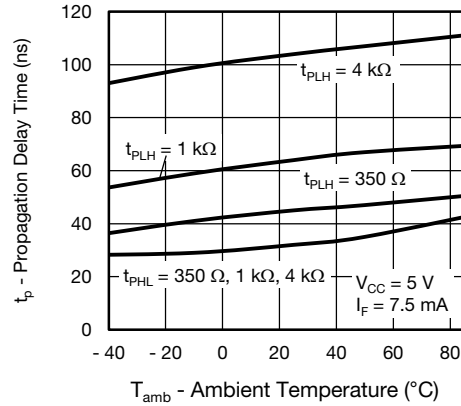


Fig. 12 - Propagation Delay Time vs. Ambient Temperature

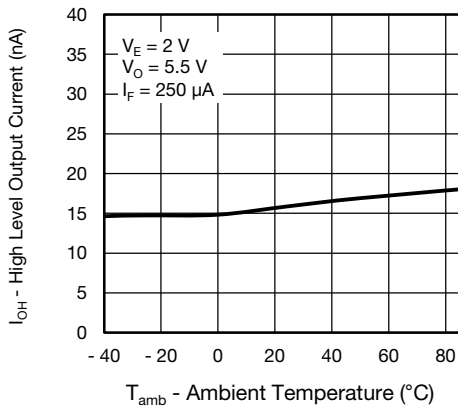


Fig. 10 - High Level Output Current vs. Ambient Temperature

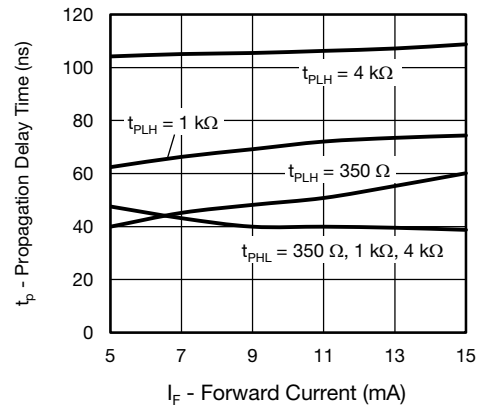


Fig. 13 - Propagation Delay Time vs. Diode Forward Current

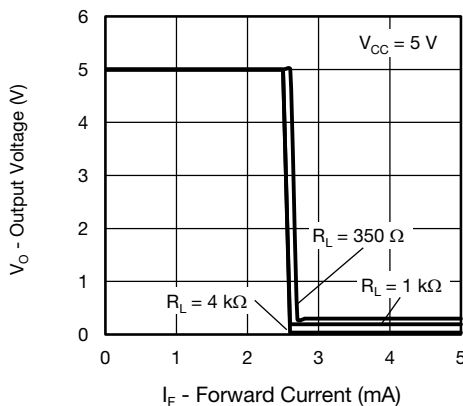


Fig. 11 - Output Voltage vs. Diode Forward Current

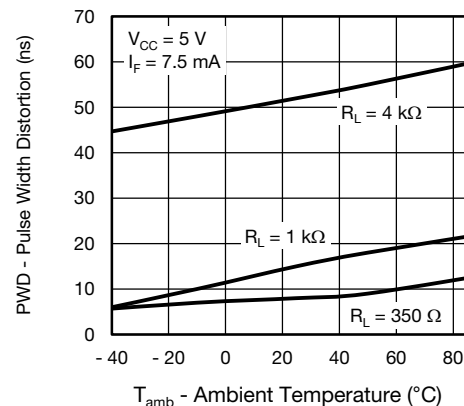


Fig. 14 - Pulse Width Distortion vs. Ambient Temperature

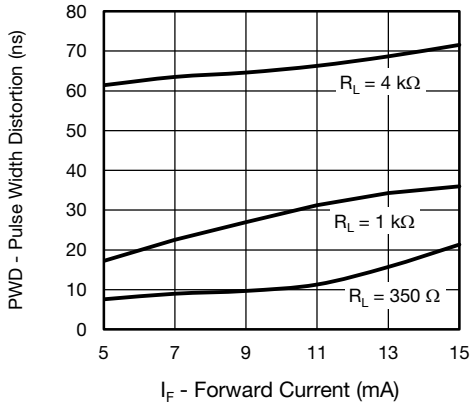


Fig. 15 - Pulse Width Distortion vs. Diode Input Current

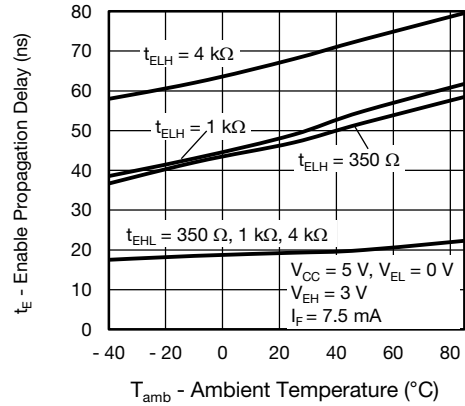


Fig. 17 - Enable Propagation Delay vs. Ambient Temperature

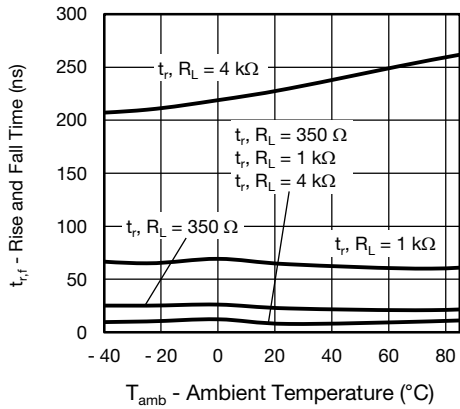


Fig. 16 - Rise And Fall Time vs. Ambient Temperature

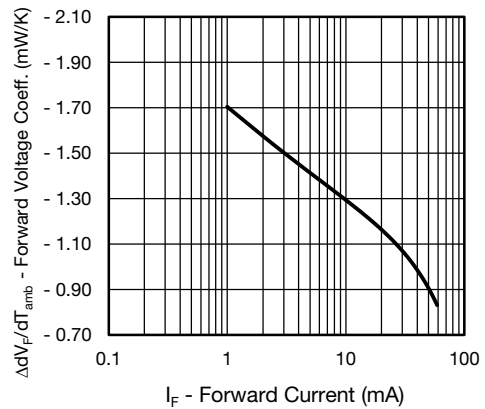
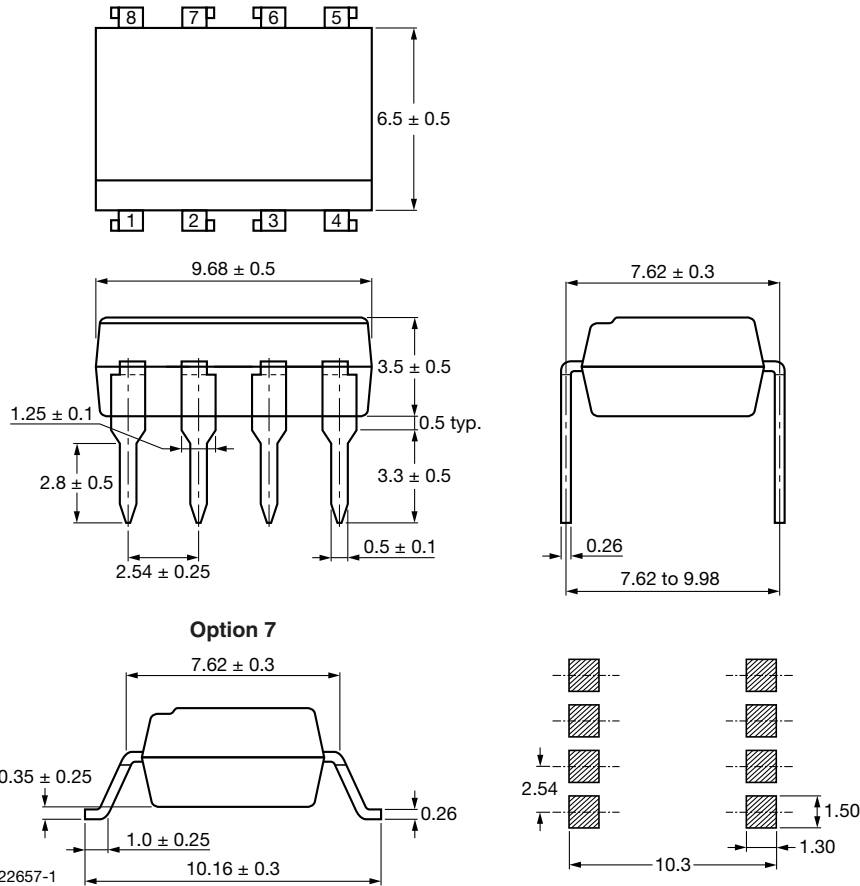
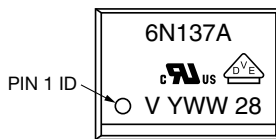


Fig. 18 - Forward Voltage Coefficient vs. Forward Current

PACKAGE DIMENSIONS in millimeters



PACKAGE MARKING



Notes

- VDE logo is only marked on option 1 parts. Option information is not marked on the part.
- Tape and reel suffix (T) is not part of the package marking.

PACKING INFORMATION

DEVICE PER TUBE OR REEL		
UNITS/TUBE	TUBES/BOX	UNITS/BOX
50	40	2000



TAPE AND REEL PACKAGING FOR OPTION 7 (dimensions in millimeters)

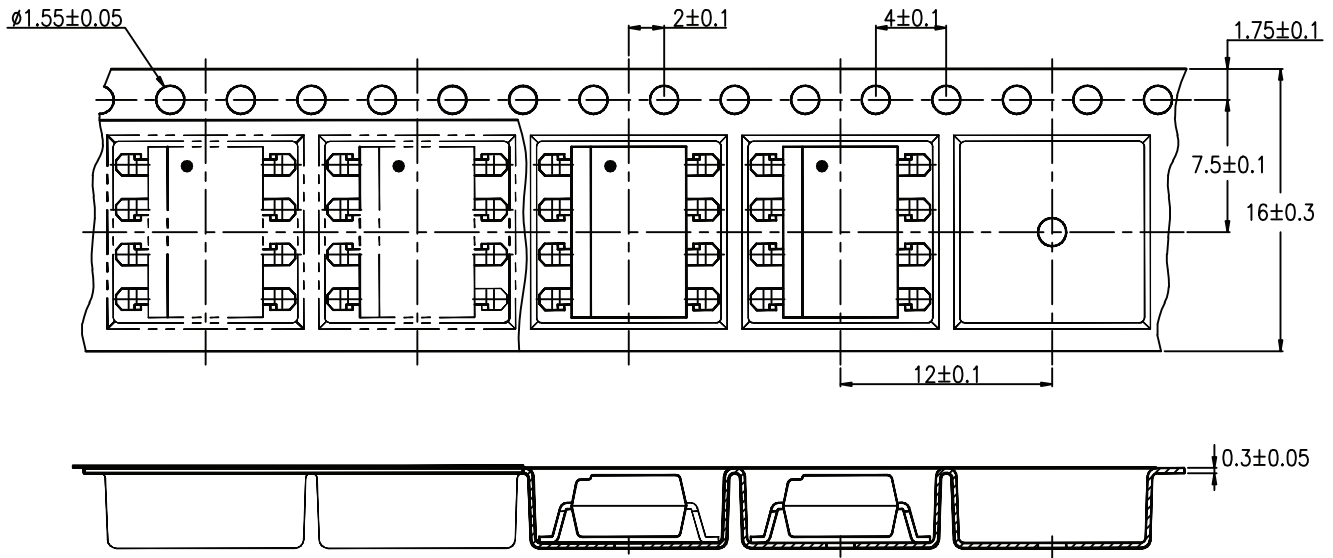


Fig. 19 - Reel Dimensions (1000 units per reel)



Disclaimer

ALL PRODUCT, PRODUCT SPECIFICATIONS AND DATA ARE SUBJECT TO CHANGE WITHOUT NOTICE TO IMPROVE RELIABILITY, FUNCTION OR DESIGN OR OTHERWISE.

Vishay Intertechnology, Inc., its affiliates, agents, and employees, and all persons acting on its or their behalf (collectively, "Vishay"), disclaim any and all liability for any errors, inaccuracies or incompleteness contained in any datasheet or in any other disclosure relating to any product.

Vishay makes no warranty, representation or guarantee regarding the suitability of the products for any particular purpose or the continuing production of any product. To the maximum extent permitted by applicable law, Vishay disclaims (i) any and all liability arising out of the application or use of any product, (ii) any and all liability, including without limitation special, consequential or incidental damages, and (iii) any and all implied warranties, including warranties of fitness for particular purpose, non-infringement and merchantability.

Statements regarding the suitability of products for certain types of applications are based on Vishay's knowledge of typical requirements that are often placed on Vishay products in generic applications. Such statements are not binding statements about the suitability of products for a particular application. It is the customer's responsibility to validate that a particular product with the properties described in the product specification is suitable for use in a particular application. Parameters provided in datasheets and / or specifications may vary in different applications and performance may vary over time. All operating parameters, including typical parameters, must be validated for each customer application by the customer's technical experts. Product specifications do not expand or otherwise modify Vishay's terms and conditions of purchase, including but not limited to the warranty expressed therein.

Hyperlinks included in this datasheet may direct users to third-party websites. These links are provided as a convenience and for informational purposes only. Inclusion of these hyperlinks does not constitute an endorsement or an approval by Vishay of any of the products, services or opinions of the corporation, organization or individual associated with the third-party website. Vishay disclaims any and all liability and bears no responsibility for the accuracy, legality or content of the third-party website or for that of subsequent links.

Except as expressly indicated in writing, Vishay products are not designed for use in medical, life-saving, or life-sustaining applications or for any other application in which the failure of the Vishay product could result in personal injury or death. Customers using or selling Vishay products not expressly indicated for use in such applications do so at their own risk. Please contact authorized Vishay personnel to obtain written terms and conditions regarding products designed for such applications.

No license, express or implied, by estoppel or otherwise, to any intellectual property rights is granted by this document or by any conduct of Vishay. Product names and markings noted herein may be trademarks of their respective owners.