

1-stage filter with 1-phase CEE connector



CEE Connector
yellow

CEE Connector
blue

See below:
[Approvals and Compliances](#)

Description

- Line filter in industrial version
- 1 stage
- high attenuation

Unique Selling Proposition

- First CEE power entry module with filter
- Easy prewired solution
- Universal flange for front or rear mounting
- Optimal filter position direct on the power entry

Characteristics

- Protection against interference voltage from the mains
- Possible interferences generated in the equipment are strongly attenuated
- Suitable for equipment with detachable power cord

Weblinks

[pdf data sheet](#), [html datasheet](#), [General Product Information](#), [Approvals](#), [Distributor-Stock-Check](#), [Detailed request for product](#), [Microsite](#)

Technical Data

Ratings IEC	16 - 32 A @ Ta 40 °C / 250 VAC; 50 Hz
Ratings UL/CSA	16 - 30 A @ Ta 40 °C / 125/250 VAC; 60 Hz
Leakage Current	industrial < 1 mA (250 V / 50 Hz)
Dielectric Strength	2.25 kVDC between L-N 2.25 kVDC between L/N-PE Test voltage (2 sec)
Allowable Operation Temperature	-40 °C to 85 °C
Climatic Category	40/085/21 acc. to IEC 60068-1
IP-Protection	IP20 IEC 60529
Protection Class	Suitable for appliances with protection class I acc. to IEC 61140
Terminal	Screw clamps
Material: Housing	Metal

Line Filter	Industrial version, IEC 60939, UL 1283, CSA C22.2 no. 8 Technical Details
MTBF	> 200'000h acc. to MIL-HB-217 F

Approvals and Compliances



Detailed information on product approvals, code requirements, usage instructions and detailed test conditions can be looked up in [Details about Approvals](#)

SCHURTER products are designed for use in industrial environments. They have approvals from independent testing bodies according to national and international standards. Products with specific characteristics and requirements such as required in the automotive sector according to IATF 16949, medical technology according to ISO 13485 or in the aerospace industry can be offered exclusively with customer-specific, individual agreements by SCHURTER.

Approvals



The approval mark is used by the testing authorities to certify compliance with the safety requirements placed on electronic products.

Approval Reference Type: FMAB CEE

Approval Logo	Certificates	Certification Body	Description
	SEMKO Approvals	SEMKO	Certificate Number: SE/09137-3
	UL Approvals	UL	UL File Number: E72928

Product standards

Product standards that are referenced

Organization	Design	Standard	Description
	Designed according to	IEC 60939	Passive filters for suppressing electromagnetic interference
	Designed according to	UL 1283	Electromagnetic interference filters
	Designed according to	CSA C22.2 no. 8	Electromagnetic interference (EMI) filters





Application standards

Application standards where the product can be used

Organization	Design	Standard	Description
	Designed for applications acc.	IEC/UL 62368-1	Audio/video, information and communication technology equipment - Part 1: Safety requirements

Compliances

The product complies with following Guide Lines

Identification	Details	Initiator	Description
	CE declaration of conformity	SCHURTER AG	The CE marking declares that the product complies with the applicable requirements laid down in the harmonisation of Community legislation on its affixing in accordance with EU Regulation 765/2008.
	UKCA declaration of conformity	SCHURTER AG	The UKCA marking declares that the product complies with the applicable requirements laid down in the British Amendment of Regulation (EC) 765/2008.
	RoHS	SCHURTER AG	Directive RoHS 2011/65/EU, Amendment (EU) 2015/863
	China RoHS	SCHURTER AG	The law SJ / T 11363-2006 (China RoHS) has been in force since 1 March 2007. It is similar to the EU directive RoHS.
	REACH	SCHURTER AG	On 1 June 2007, Regulation (EC) No 1907/2006 on the Registration, Evaluation, Authorization and Restriction of Chemicals 1 (abbreviated as "REACH") entered into force.

Dimension [mm]

Case QU

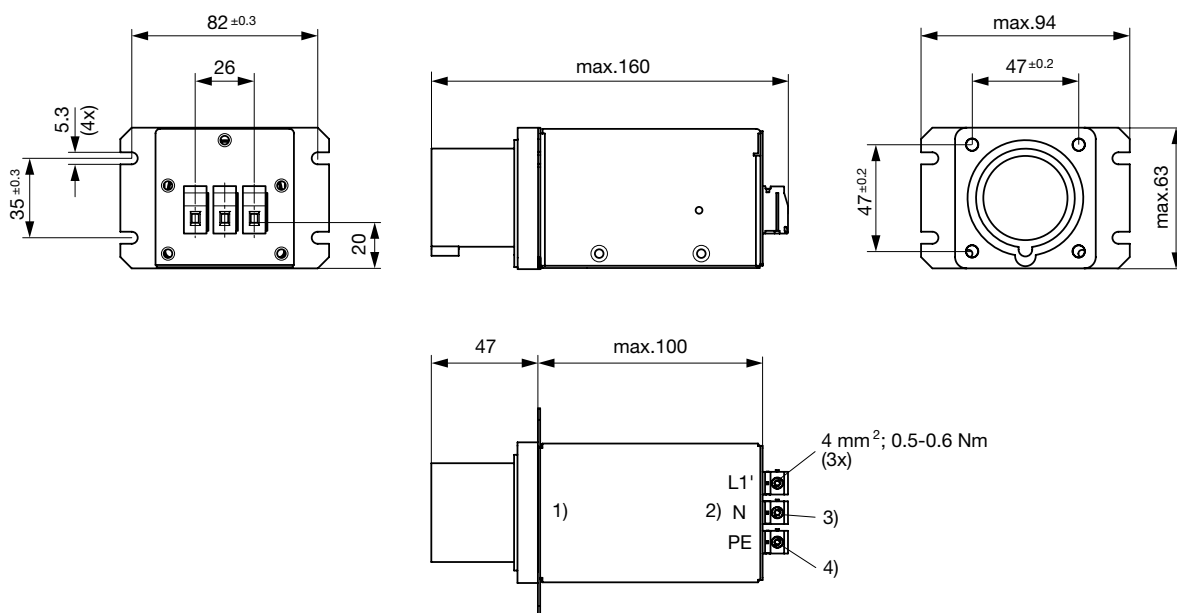

- 1) Line
- 2) Load
- 3) Blue
- 4) Yellow-Green

Case QT

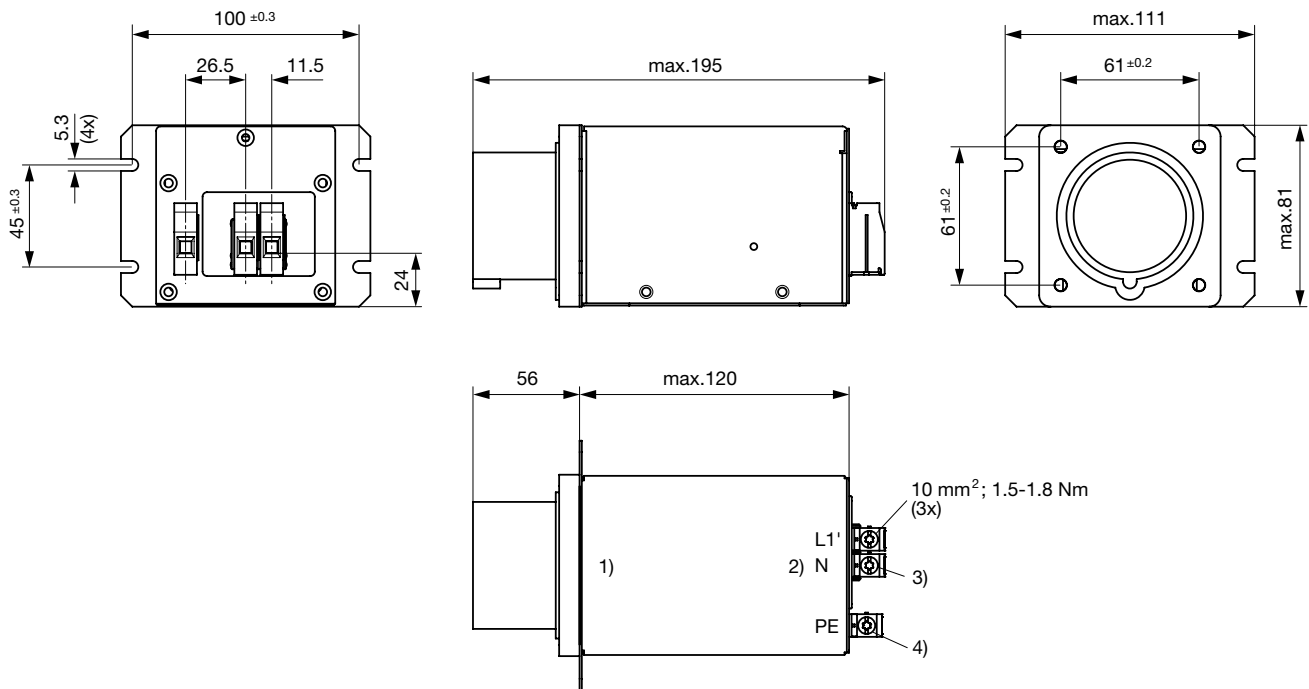

- 1) Line
- 2) Load
- 3) Blue
- 4) Yellow-Green

Diagrams

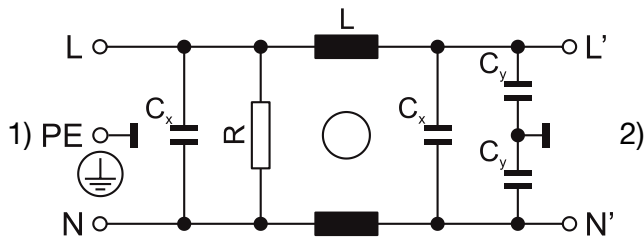

- 1) Line
- 2) Load

Attenuation Loss 0.1/100Ω differential mode 100/0.1Ω differential mode - - - - 50Ω differential mode ____ 50Ω common mode
 Industrial version

16 A

30 / 32 A

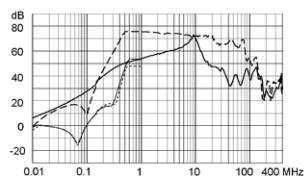
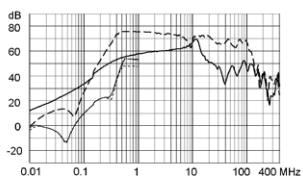

All Variants

Rated Current @ Ta 50°C (40°C) [A]	Rated Voltage [VAC]	Powerloss @ 25°C, 50Hz [W]	Leakage Current @ 400VAC, 50Hz [mA]1)	Weight [kg]	Screw clamps [mm2] 2)	Housing	Packaging unit	Order Number
16	110	3	0.5	650 g	4	QU	1	5500.2359
16	125/250	3	1	650 g	4	QU	1	5500.2360
30	125	4.5	0.5	1100 g	10	QT	1	5500.2361
32	125/250	5.1	1	1100 g	10	QT	1	5500.2362

Most Popular:

Availability for all products can be searched real-time: <https://www.schurter.com/en/Stock-Check/Stock-Check-SCHURTER>

- 1) Leakage current acc. IEC60950 - 5.2.3 - Annex D (situation when neutral is interrupted)
- 2) Maximum conductor cross section (wire gauge) to be used; a comparative table for AWG and mm² values can be found in the general product information <https://www.schurter.com/en/FAQ#10>