

## 60 A VRPower<sup>®</sup> Integrated Power Stage

### DESCRIPTION

The SiC620 and SiC620A are integrated power stage solutions optimized for synchronous buck applications to offer high current, high efficiency, and high power density performance. Packaged in Vishay's proprietary 5 mm x 5 mm MLP package, SiC620 and SiC620A enables voltage regulator designs to deliver up to 60 A continuous current per phase.

The internal power MOSFETs utilizes Vishay's state-of-the-art Gen IV TrenchFET<sup>®</sup> technology that delivers industry benchmark performance to significantly reduce switching and conduction losses.

The SiC620 and SiC620A incorporates an advanced MOSFET gate driver IC that features high current driving capability, adaptive dead-time control, an integrated bootstrap Schottky diode, a thermal warning (THWn) that alerts the system of excessive junction temperature, and zero current detect to improve light load efficiency. The drivers are also compatible with a wide range of PWM controllers and supports tri-state PWM, 3.3 V (SiC620A), 5 V (SiC620) PWM logic.

### FEATURES

- Thermally enhanced PowerPAK<sup>®</sup> MLP55-31L package
- Vishay's Gen IV MOSFET technology and a low-side MOSFET with integrated Schottky diode
- Delivers up to 60 A continuous current
- 95 % peak efficiency
- High frequency operation up to 1.5 MHz
- Power MOSFETs optimized for 12 V input stage
- 3.3 V (SiC620A), 5 V (SiC620) PWM logic with tri-state and hold-off
- Zero current detect control for light load efficiency improvement
- Low PWM propagation delay (< 20 ns)
- Thermal monitor flag
- Under voltage lockout for  $V_{CIN}$
- Material categorization: for definitions of compliance please see [www.vishay.com/doc?99912](http://www.vishay.com/doc?99912)



**RoHS**  
COMPLIANT  
HALOGEN  
**FREE**

### APPLICATIONS

- Multi-phase VRDs for CPU, GPU, and memory

### TYPICAL APPLICATION DIAGRAM

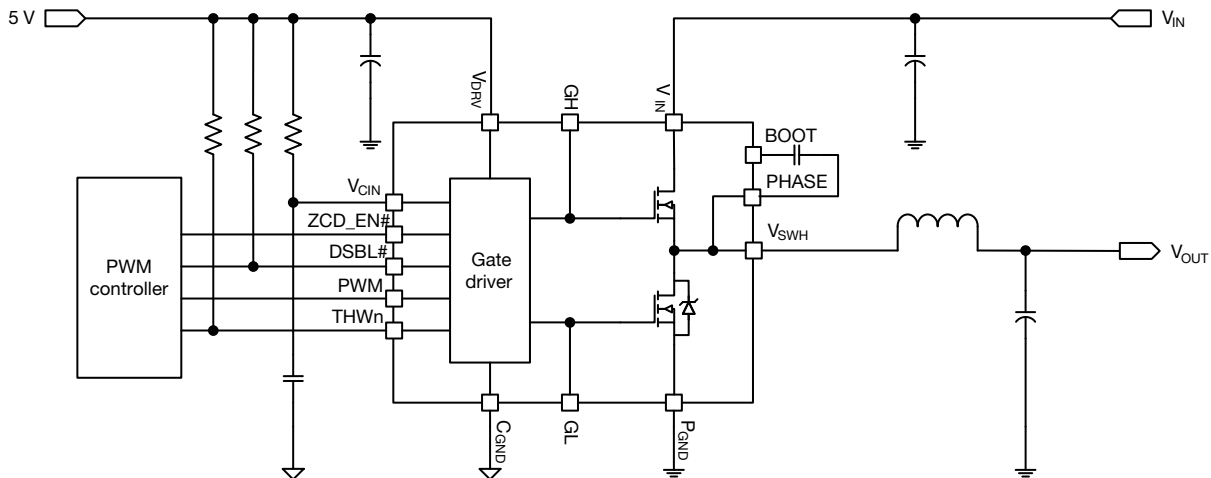
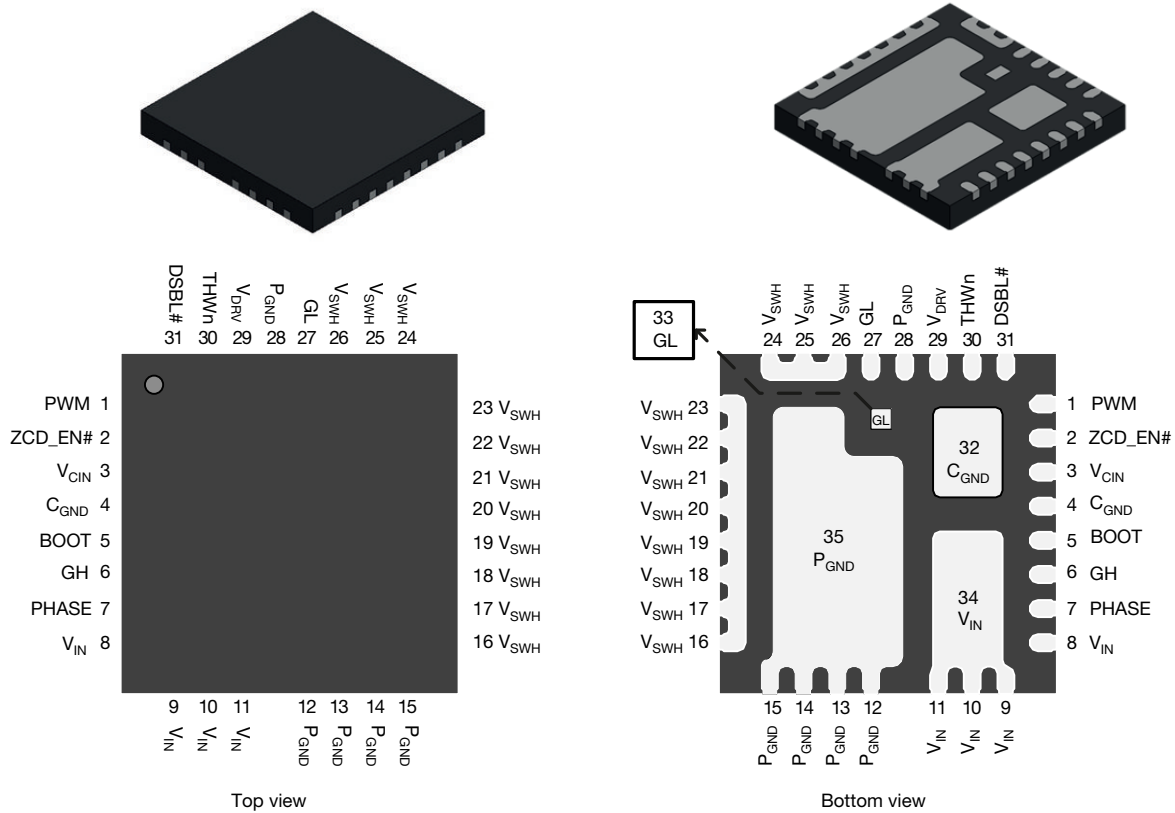

Fig. 1 - SiC620 and SiC620A Typical Application Diagram

**PINOUT CONFIGURATION**

**Fig. 2 - SiC620 and SiC620A Pin Configuration**

PIN CONFIGURATION		
PIN NUMBER	NAME	FUNCTION
1	PWM	PWM control input
2	ZCD_EN#	ZCD control. Active low
3	V <sub>CIN</sub>	Supply voltage for internal logic circuitry
4, 32	C <sub>GND</sub>	Analog ground for the driver IC
5	BOOT	High-side driver bootstrap voltage
6	GH	High-side gate signal
7	PHASE	Return path of high-side gate driver
8 to 11, 34	V <sub>IN</sub>	Power stage input voltage. Drain of high-side MOSFET
12 to 15, 28, 35	P <sub>GND</sub>	Power ground
16 to 26	V <sub>SWH</sub>	Switch node of the power stage
27, 33	GL	Low-side gate signal
29	V <sub>DRV</sub>	Supply voltage for internal gate driver
30	THWn	Thermal warning open drain output
31	DSBL#	Disable pin. Active low

ORDERING INFORMATION			
PART NUMBER	PACKAGE	MARKING CODE	OPTION
SiC620CD-T1-GE3	PowerPAK MLP55-31L	SiC620	5 V PWM optimized
SiC620ACD-T1-GE3	PowerPAK MLP55-31L	SiC620A	3.3 V PWM optimized
SiC620DB / SiC620ADB		Reference board	



ABSOLUTE MAXIMUM RATINGS			
ELECTRICAL PARAMETER	CONDITIONS	LIMIT	UNIT
Input voltage	$V_{IN}$	-0.3 to +25	V
Control logic supply voltage	$V_{CIN}$	-0.3 to +7	
Drive supply voltage	$V_{DRV}$	-0.3 to +7	
Switch node (DC voltage)	$V_{SWH}$	-0.3 to +25	
Switch node (AC voltage) <sup>(1)</sup>		-7 to +30	
BOOT voltage (DC voltage)	$V_{BOOT}$	32	
BOOT voltage (AC voltage) <sup>(2)</sup>		38	
BOOT to PHASE (DC voltage)	$V_{BOOT-PHASE}$	-0.3 to +7	
BOOT to PHASE (AC voltage) <sup>(3)</sup>		-0.3 to +8	
All logic inputs and outputs (PWM, DSBL#, and THWn)		-0.3 to $V_{CIN} + 0.3$	
Output current, $I_{OUT(AV)}$ <sup>(4)</sup>	$f_S = 300$ kHz, $V_{IN} = 12$ V, $V_{OUT} = 1.8$ V	60	A
	$f_S = 1$ MHz, $V_{IN} = 12$ V, $V_{OUT} = 1.8$ V	50	
Max. operating junction temperature	$T_J$	150	°C
Ambient temperature	$T_A$	-40 to +125	
Storage temperature	$T_{stg}$	-65 to +150	
Electrostatic discharge protection	Human body model, JESD22-A114	3000	V
	Charged device model, JESD22-C101	1000	

**Notes**

- Stresses beyond those listed under “Absolute Maximum Ratings” may cause permanent damage to the device. These are stress ratings only, and functional operation of the device at these or any other conditions beyond those indicated in the operational sections of the specifications is not implied. Exposure to absolute maximum rating conditions for extended periods may affect device reliability
- (1) The specification values indicated “AC” is  $V_{SWH}$  to  $P_{GND}$  -8 V (< 20 ns, 10  $\mu$ J), min. and 30 V (< 50 ns), max.
- (2) The specification value indicates “AC voltage” is  $V_{BOOT}$  to  $P_{GND}$ , 38 V (< 50 ns) max.
- (3) The specification value indicates “AC voltage” is  $V_{BOOT}$  to  $V_{PHASE}$ , 8 V (< 20 ns) max.
- (4) Output current rated with testing evaluation board at  $T_A = 25$  °C with natural convection cooling. The rating is limited by the peak evaluation board temperature,  $T_J$

RECOMMENDED OPERATING RANGE				
ELECTRICAL PARAMETER	MINIMUM	TYPICAL	MAXIMUM	UNIT
Input voltage ( $V_{IN}$ )	4.5	-	18	V
Drive supply voltage ( $V_{DRV}$ )	4.5	5	5.5	
Control logic supply voltage ( $V_{CIN}$ )	4.5	5	5.5	
Switch node ( $V_{SWH}$ , DC voltage)	-	-	18	
BOOT to PHASE ( $V_{BOOT-PHASE}$ , DC voltage)	4	4.5	5.5	
Thermal resistance from junction to ambient	-	10.6	-	°C/W
Thermal resistance from junction to case	-	1.6	-	



<b>ELECTRICAL SPECIFICATIONS</b>						
(DSBL# = ZCD_EN# = 5 V, V <sub>IN</sub> = 12 V, V <sub>DRV</sub> and V <sub>CIN</sub> = 5 V, T <sub>A</sub> = 25 °C)						
PARAMETER	SYMBOL	TEST CONDITION	LIMITS			UNIT
			MIN.	TYP.	MAX.	
<b>POWER SUPPLY</b>						
Control logic supply current	I <sub>VCIN</sub>	V <sub>DSBL#</sub> = 0 V, no switching	-	12	-	μA
		V <sub>DSBL#</sub> = 5 V, no switching, V <sub>PWM</sub> = FLOAT	-	300	-	
		V <sub>DSBL#</sub> = 5 V, f <sub>S</sub> = 300 kHz, D = 0.1	-	380	-	
Drive supply current	I <sub>VDRV</sub>	f <sub>S</sub> = 300 kHz, D = 0.1	-	15	25	mA
		f <sub>S</sub> = 1 MHz, D = 0.1	-	50	-	
		V <sub>DSBL#</sub> = 0 V, no switching	-	25	-	μA
		V <sub>DSBL#</sub> = 5 V, no switching	-	60	-	
		<b>BOOTSTRAP SUPPLY</b>				
Bootstrap diode forward voltage	V <sub>F</sub>	I <sub>F</sub> = 2 mA	-	-	0.4	V
<b>PWM CONTROL INPUT (SiC620)</b>						
Rising threshold	V <sub>TH_PWM_R</sub>		3.4	3.8	4.2	V
Falling threshold	V <sub>TH_PWM_F</sub>		0.72	0.9	1.1	
Tri-state voltage	V <sub>TRI</sub>	V <sub>PWM</sub> = FLOAT	-	2.3	-	
Tri-state rising threshold	V <sub>TRI_TH_R</sub>		0.9	1.15	1.38	
Tri-state falling threshold	V <sub>TRI_TH_F</sub>		3	3.3	3.6	
Tri-state rising threshold hysteresis	V <sub>HYS_TRI_R</sub>		-	225	-	mV
Tri-state falling threshold hysteresis	V <sub>HYS_TRI_F</sub>		-	325	-	
PWM input current	I <sub>PWM</sub>	V <sub>PWM</sub> = 5 V	-	-	350	μA
		V <sub>PWM</sub> = 0 V	-	-	-350	
<b>PWM CONTROL INPUT (SiC620A)</b>						
Rising threshold	V <sub>TH_PWM_R</sub>		2.2	2.45	2.7	V
Falling threshold	V <sub>TH_PWM_F</sub>		0.72	0.9	1.1	
Tri-state voltage	V <sub>TRI</sub>	V <sub>PWM</sub> = FLOAT	-	1.8	-	
Tri-state rising threshold	V <sub>TRI_TH_R</sub>		0.9	1.15	1.38	
Tri-state falling threshold	V <sub>TRI_TH_F</sub>		1.95	2.2	2.45	
Tri-state rising threshold hysteresis	V <sub>HYS_TRI_R</sub>		-	250	-	mV
Tri-state falling threshold hysteresis	V <sub>HYS_TRI_F</sub>		-	300	-	
PWM input current	I <sub>PWM</sub>	V <sub>PWM</sub> = 3.3 V	-	-	225	μA
		V <sub>PWM</sub> = 0 V	-	-	-225	
<b>TIMING SPECIFICATIONS</b>						
Tri-state to GH/GL rising propagation delay	t <sub>PD_TRI_R</sub>	No load, see fig. 4	-	30	-	ns
Tri-state hold-off time	t <sub>TSHO</sub>		-	130	-	
GH - turn off propagation delay	t <sub>PD_OFF_GH</sub>		-	15	-	
GH - turn on propagation delay (dead time rising)	t <sub>PD_ON_GH</sub>		-	10	-	
GL - turn off propagation delay	t <sub>PD_OFF_GL</sub>		-	12	-	
GL - turn on propagation delay (dead time falling)	t <sub>PD_ON_GL</sub>		-	10	-	
DSBL# Lo to GH/GL falling propagation delay	t <sub>PD_DSBL#_F</sub>	Fig. 5	-	15	-	
PWM minimum on-time	t <sub>PWM_ON_MIN</sub>		30	-	-	



<b>ELECTRICAL SPECIFICATIONS</b>						
(DSBL# = ZCD_EN# = 5 V, $V_{IN}$ = 12 V, $V_{DRV}$ and $V_{CIN}$ = 5 V, $T_A$ = 25 °C)						
PARAMETER	SYMBOL	TEST CONDITION	LIMITS			UNIT
			MIN.	TYP.	MAX.	
<b>DSBL# ZCD_EN# INPUT</b>						
DSBL# logic input voltage	$V_{IH\_DSBL\#}$	Input logic high	2	-	-	V
	$V_{IL\_DSBL\#}$	Input logic low	-	-	0.8	
ZCD_EN# logic input voltage	$V_{IH\_ZCD\_EN\#}$	Input logic high	2	-	-	
	$V_{IL\_ZCD\_EN\#}$	Input logic low	-	-	0.8	
<b>PROTECTION</b>						
Under voltage lockout	$V_{UVLO}$	$V_{CIN}$ rising, on threshold	-	3.7	4.1	V
		$V_{CIN}$ falling, off threshold	2.7	3.1	-	
Under voltage lockout hysteresis	$V_{UVLO\_HYST}$		-	575	-	mV
THWn flag set <sup>(2)</sup>	$T_{THWn\_SET}$		-	160	-	°C
THWn flag clear <sup>(2)</sup>	$T_{THWn\_CLEAR}$		-	135	-	
THWn flag hysteresis <sup>(2)</sup>	$T_{THWn\_HYST}$		-	25	-	
THWn output low	$V_{OL\_THWn}$	$I_{THWn} = 2$ mA	-	0.02	-	V

**Notes**

- (1) Typical limits are established by characterization and are not production tested  
(2) Guaranteed by design

**DETAILED OPERATIONAL DESCRIPTION****PWM Input with Tri-state Function**

The PWM input receives the PWM control signal from the VR controller IC. The PWM input is designed to be compatible with standard controllers using two state logic (H and L) and advanced controllers that incorporate tri-state logic (H, L and tri-state) on the PWM output. For two state logic, the PWM input operates as follows. When PWM is driven above  $V_{PWM\_TH\_R}$  the low-side is turned on and the high-side is turned on. When PWM input is driven below  $V_{PWM\_TH\_F}$  the high-side is turned off and the low-side is turned on. For tri-state logic, the PWM input operates as previously stated for driving the MOSFETs. However, there is an third state that is entered as the PWM output of tri-state compatible controller enters its high impedance state during shut-down. The high impedance state of the controller's PWM output allows the SiC620 and SiC620A to pull the PWM input into the tri-state region (see PWM Timing Diagram). If the PWM input stays in this region for the tri-state hold-off period,  $t_{TSHO}$ , both high-side and low-side MOSFETs are turned off. This function allows the VR phase to be disabled without negative output voltage swing caused by inductor ringing and saves a Schottky diode clamp. The PWM and tri-state regions are separated by hysteresis to prevent false triggering. The SiC620A incorporates PWM voltage thresholds that are compatible with 3.3 V logic and the SiC620 thresholds are compatible with 5 V logic.

**Disable (DSBL#)**

In the low state, the DSBL# pin shuts down the driver IC and disables both high-side and low-side MOSFETs. In this state, standby current is minimized. If DSBL# is left unconnected, an internal pull-down resistor will pull the pin to  $C_{GND}$  and shut down the IC.

**Diode Emulation Mode (ZCD\_EN#)**

When ZCD\_EN# pin is logic Low and PWM signal switches Low, GL is forced on (after normal BBM time). During this time, it is under control of the ZCD (zero crossing detect) comparator. If, after the internal blanking delay, the inductor current becomes zero, the low-side is turned off. This improves light load efficiency by avoiding discharge of output capacitors. If PWM enters tri-state, then device will go into normal tri-state mode after tri-state delay. The GL output will be turned off regardless of Inductor current, this is an alternative method of improving light load efficiency by reducing switching losses.

**Thermal Shutdown Warning (THWn)**

The THWn pin is an open drain signal that flags the presence of excessive junction temperature. Connect with a maximum of 20 k $\Omega$ , to  $V_{CIN}$ . An internal temperature sensor detects the junction temperature. The temperature threshold is 160 °C. When this junction temperature is exceeded the THWn flag is set. When the junction temperature drops below 135 °C the device will clear the THWn signal. The SiC620 and SiC620A do not stop operation when the flag is set. The decision to shutdown must be made by an external thermal control function.

**Voltage Input ( $V_{IN}$ )**

This is the power input to the drain of the high-side power MOSFET. This pin is connected to the high power intermediate BUS rail.

### Switch Node ( $V_{SWH}$ and PHASE)

The switch node,  $V_{SWH}$ , is the circuit power stage output. This is the output applied to the power inductor and output filter to deliver the output for the buck converter. The PHASE pin is internally connected to the switch node  $V_{SWH}$ . This pin is to be used exclusively as the return pin for the BOOT capacitor. A 20 k $\Omega$  resistor is connected between GH and PHASE to provide a discharge path for the HS MOSFET in the event that  $V_{CIN}$  goes to zero while  $V_{IN}$  is still applied.

### Ground Connections ( $C_{GND}$ and $P_{GND}$ )

$P_{GND}$  (power ground) should be externally connected to  $C_{GND}$  (control signal ground). The layout of the printed circuit board should be such that the inductance separating  $C_{GND}$  and  $P_{GND}$  is minimized. Transient differences due to inductance effects between these two pins should not exceed 0.5 V.

### Control and Drive Supply Voltage Input ( $V_{DRV}$ , $V_{CIN}$ )

$V_{CIN}$  is the bias supply for the gate drive control IC.  $V_{DRV}$  is the bias supply for the gate drivers. It is recommended to separate these pins through a resistor. This creates a low pass filtering effect to avoid coupling of high frequency gate drive noise into the IC.

### Bootstrap Circuit (BOOT)

The internal bootstrap diode and an external bootstrap capacitor form a charge pump that supplies voltage to the BOOT pin. An integrated bootstrap diode is incorporated so that only an external capacitor is necessary to complete the bootstrap circuit. Connect a boot strap capacitor with one leg tied to BOOT pin and the other tied to PHASE pin.

### Shoot-through Protection and Adaptive Dead Time

The SiC620 and SiC620A have an internal adaptive logic to avoid shoot through and optimize dead time. The shoot through protection ensures that both high-side and low-side MOSFETs are not turned on at the same time. The adaptive dead time control operates as follows. The HS and LS gate voltages are monitored to prevent the one turning on from turning on until the other's gate voltage is sufficiently low (< 1 V). Built in delays also ensure that one power MOS is completely off, before the other can be turned on. This feature helps to adjust dead time as gate transitions change with respect to output current and temperature. Change with respect to output current and temperature.

### Under Voltage Lockout (UVLO)

During the start up cycle, the UVLO disables the gate drive holding high-side and low-side MOSFET gates low until the supply voltage rail has reached a point at which the logic circuitry can be safely activated. The SiC620, SiC620A also incorporates logic to clamp the gate drive signals to zero when the UVLO falling edge triggers the shutdown of the device. As an added precaution, a 20 k $\Omega$  resistor is connected between GH and PHASE to provide a discharge path for the HS MOSFET.

## FUNCTIONAL BLOCK DIAGRAM

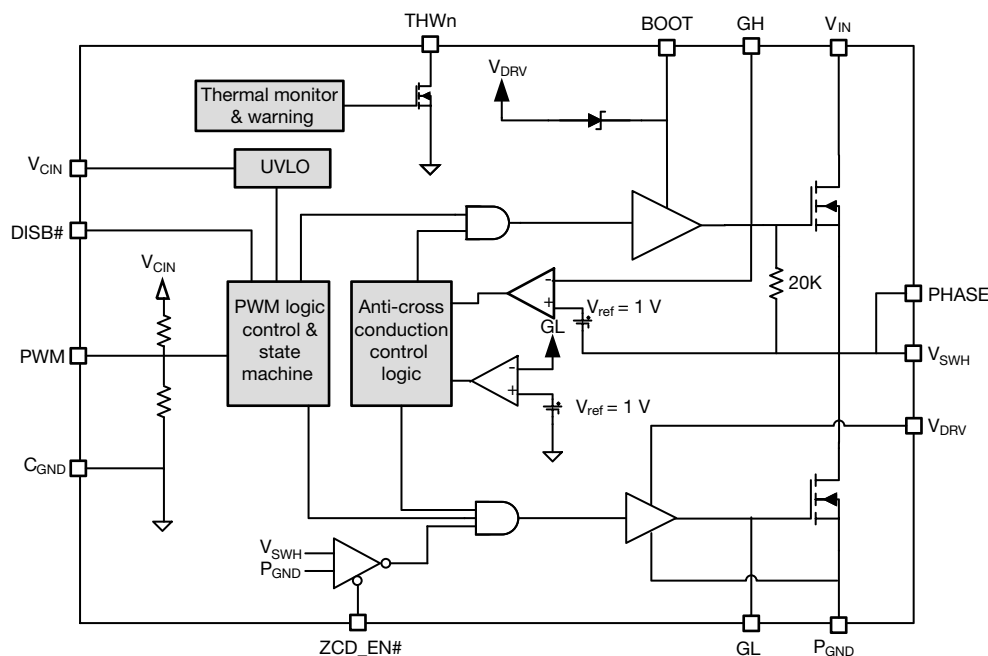
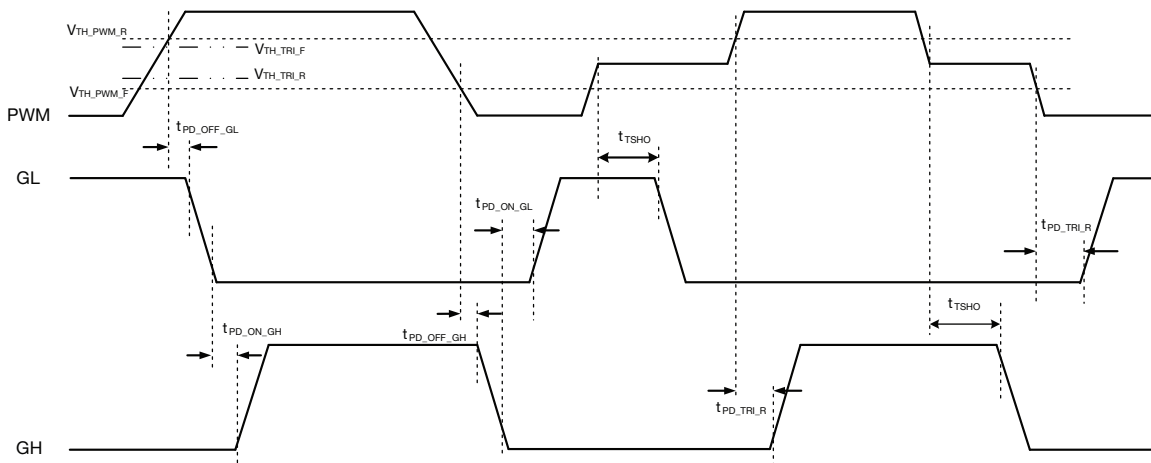
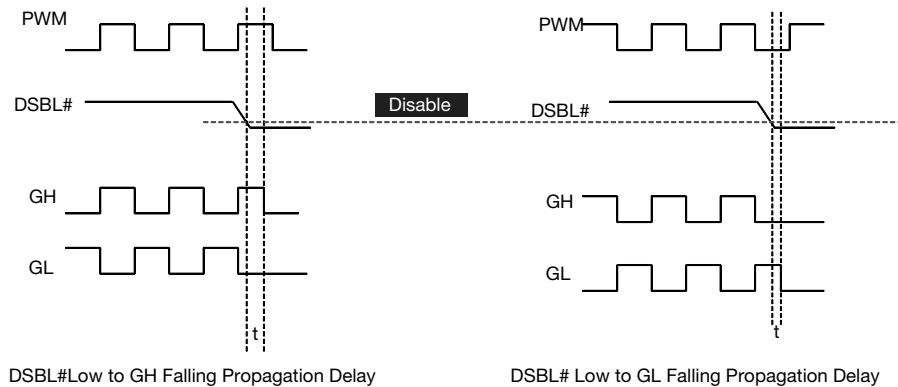

Fig. 3 - SiC620 and SiC620A Functional Block Diagram

DEVICE TRUTH TABLE				
DSBL#	ZCD_EN#	PWM	GH	GL
Open	X	X	L	L
L	X	X	L	L
H	L	L	L	H, $I_L > 0 A$ L, $I_L < 0 A$
H	L	H	H	L
H	L	Tri-state	L	L
H	H	L	L	H
H	H	H	H	L
H	H	Tri-state	L	L

**PWM TIMING DIAGRAM**

**Fig. 4 - Definition of PWM Logic and Tri-state**
**DSBL# PROPAGATION DELAY**

**Fig. 5 - DSBL# Falling Propagation Delay**

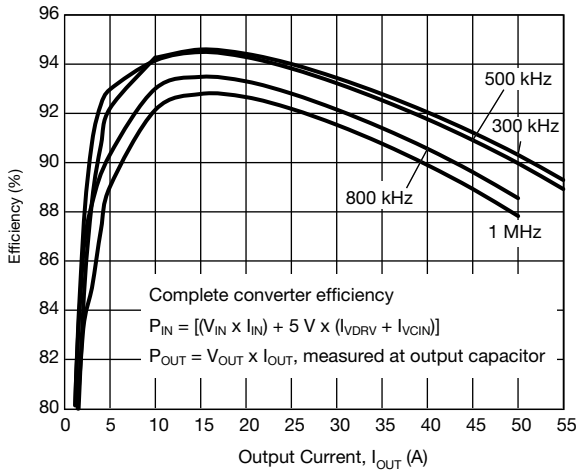
**ELECTRICAL CHARACTERISTICS**

Test condition:  $V_{IN} = 12\text{ V}$ ,  $V_{DRV} = V_{CIN} = 5\text{ V}$ ,  $ZCD\_EN\# = 5\text{ V}$ ,  $V_{OUT} = 1.8\text{ V}$ ,  $L_{OUT} = 250\text{ nH}$  (DCR = 0.32 mΩ),  $T_A = 25\text{ °C}$ , natural convection cooling (All power loss and normalized power loss curves show SiC620 and SiC620A losses only unless otherwise stated)

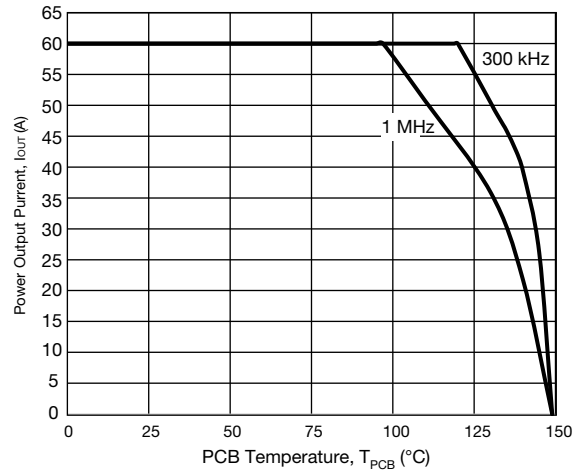

**Fig. 6 - Efficiency vs. Output Current**



**Fig. 9 - Safe Operating Area**

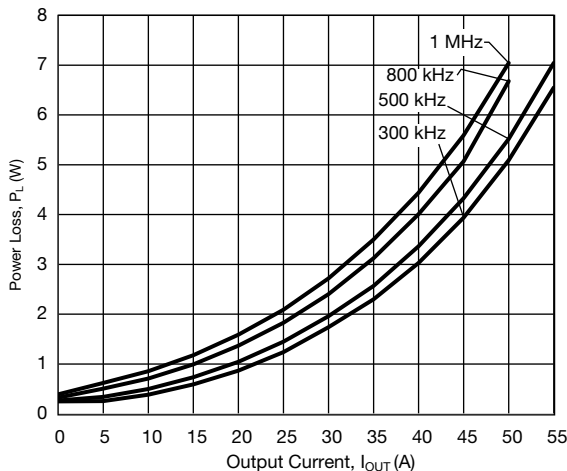

**Fig. 7 - Power Loss vs. Output Current**

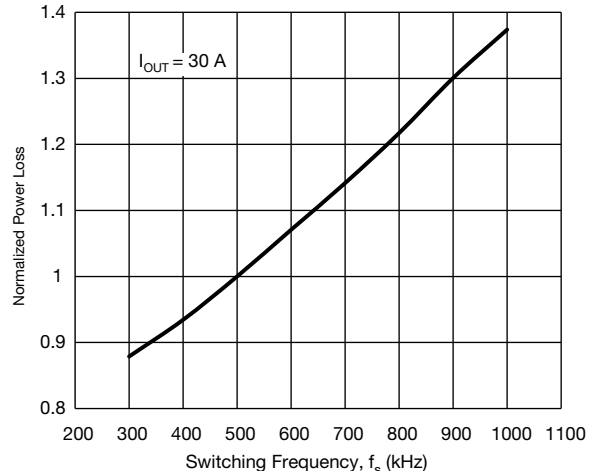

**Fig. 10 - Power Loss vs. Switching Frequency**

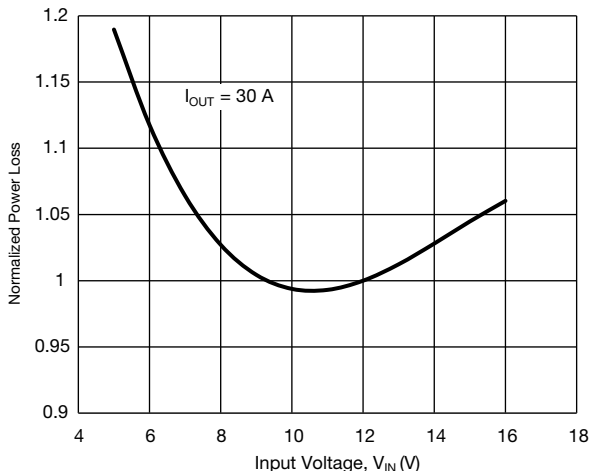

**Fig. 8 - Power Loss vs. Input Voltage**

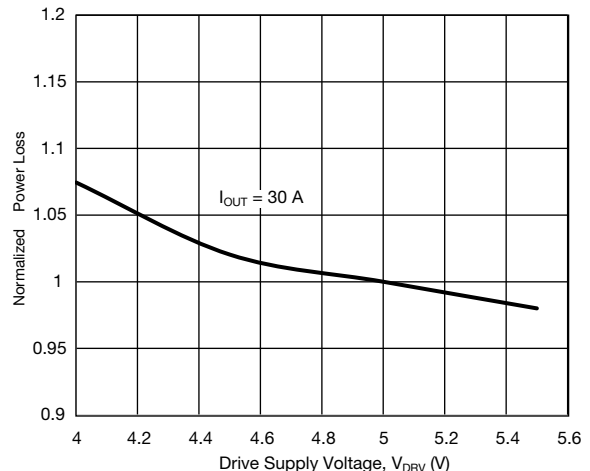

**Fig. 11 - Power Loss vs. Drive Supply Voltage**



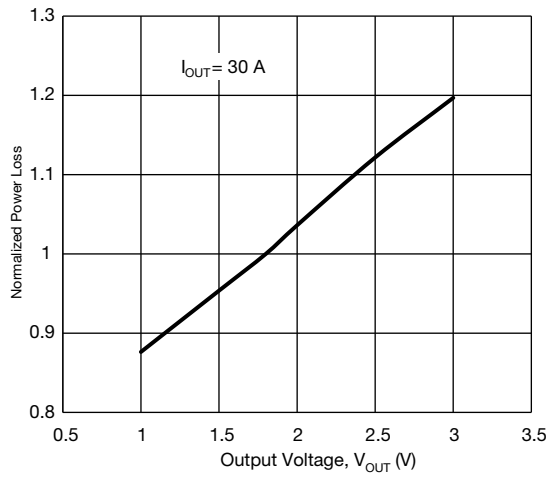

Fig. 12 - Power Loss vs. Output Voltage

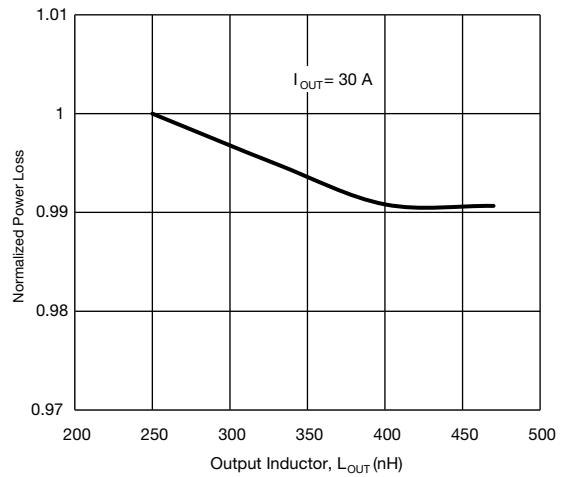

Fig. 15 - Power Loss vs. Output Inductor

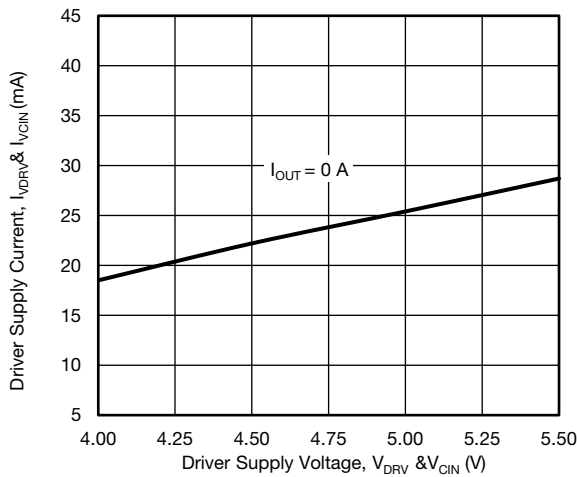

Fig. 13 - Driver Supply Current vs. Driver Supply Voltage

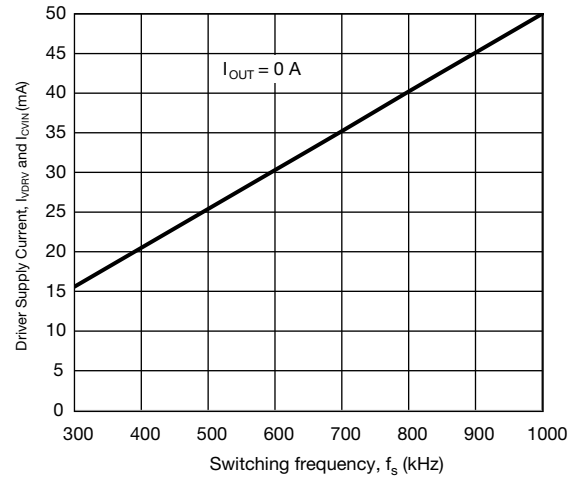

Fig. 16 - Driver Supply Current vs. Switching Frequency

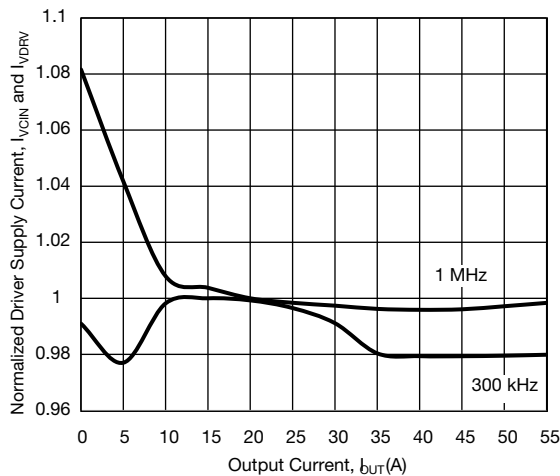

Fig. 14 - Driver Supply Current vs. Output Current

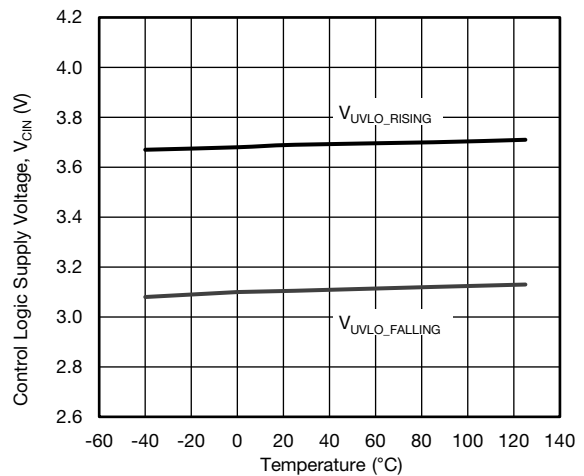

Fig. 17 - UVLO Threshold vs. Temperature

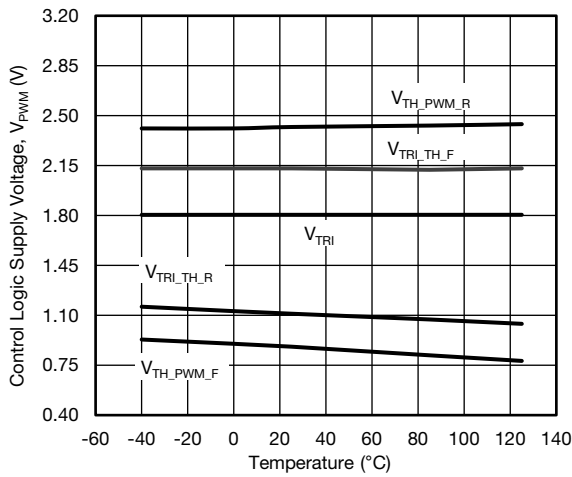

Fig. 18 - PWM Threshold vs. Temperature (SiC620A)

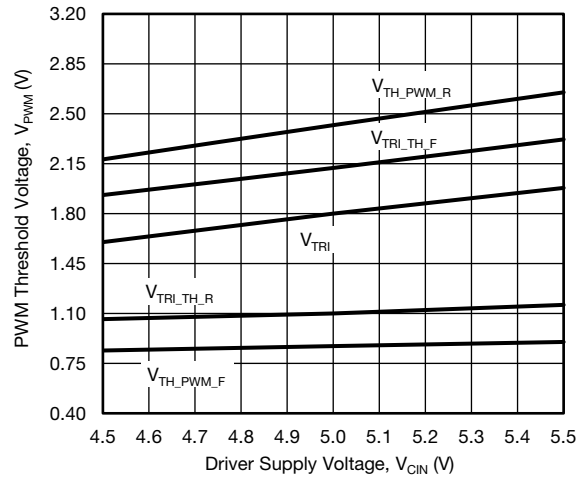

Fig. 21 - PWM Threshold vs. Driver Supply Voltage (SiC620A)

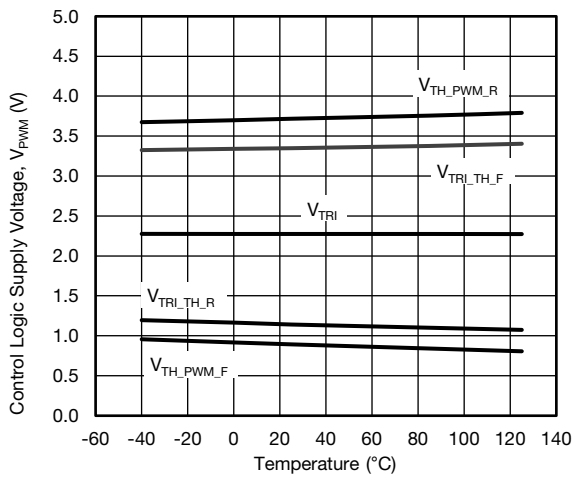

Fig. 19 - PWM Threshold vs. Temperature (SiC620)

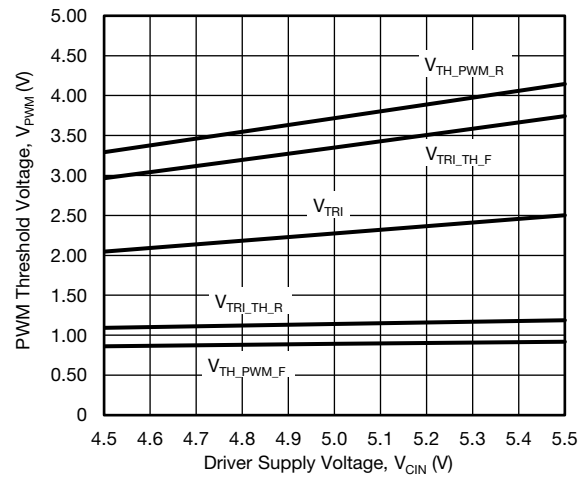

Fig. 22 - PWM Threshold vs. Driver Supply Voltage (SiC620)

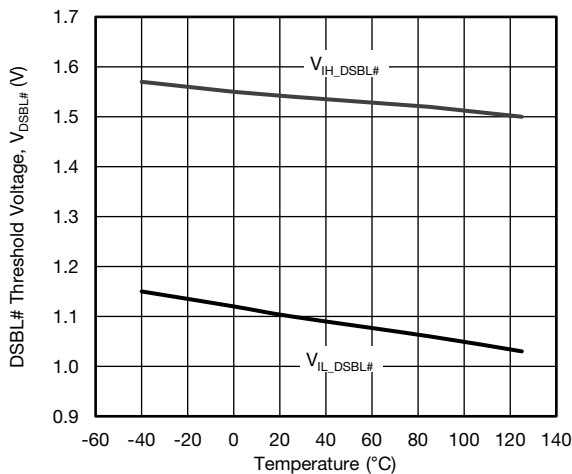

Fig. 20 - DSBL# Threshold vs. Temperature

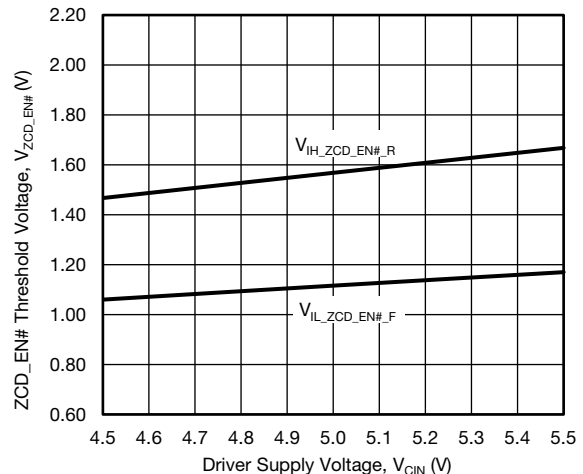
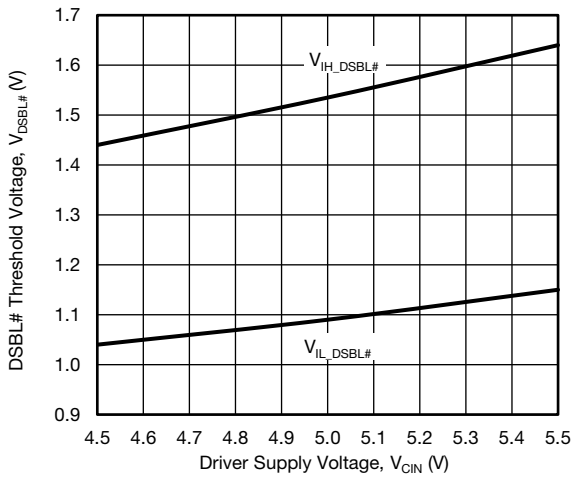
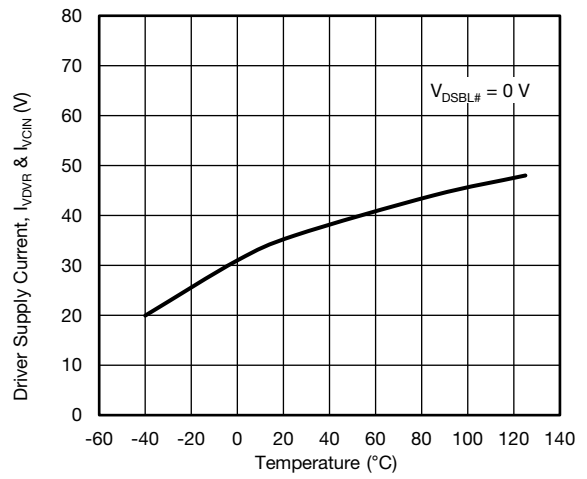

Fig. 23 - ZCD\_EN# Threshold vs. Driver Supply Voltage



**Fig. 24 - DSBL# vs. Driver Input Voltage**



**Fig. 27 - Driver Shutdown Current vs. Temperature**

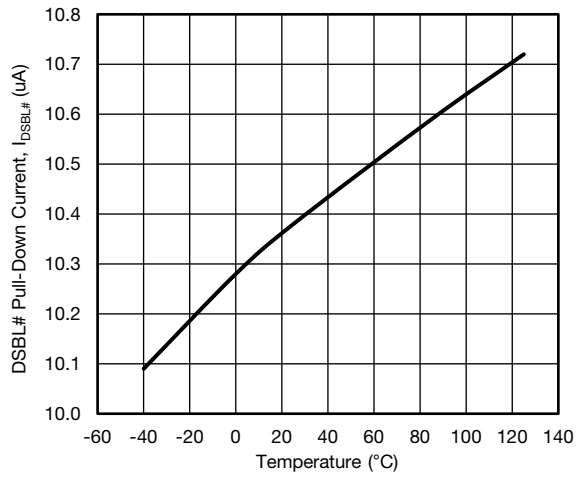

**Fig. 25 - DSBL# Pull-Down Current vs. Temperature**

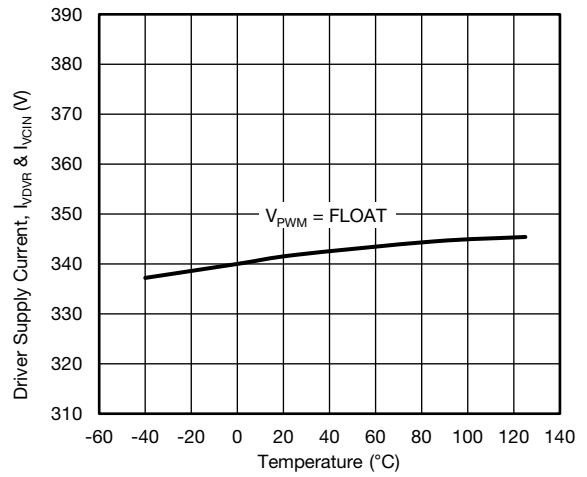

**Fig. 28 - Driver Supply Current vs. Temperature**

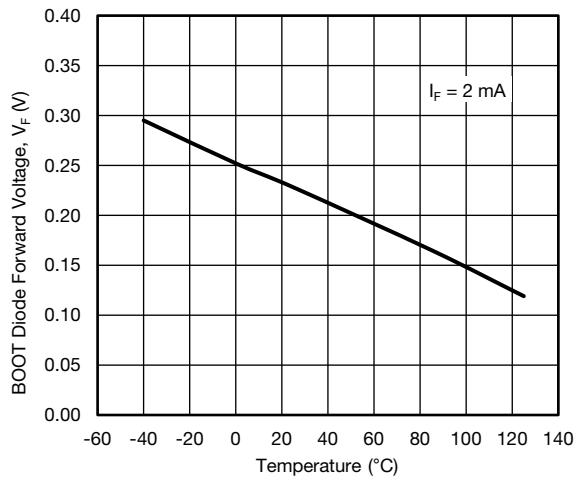

**Fig. 26 - Boot Diode Forward Voltage vs. Temperature**

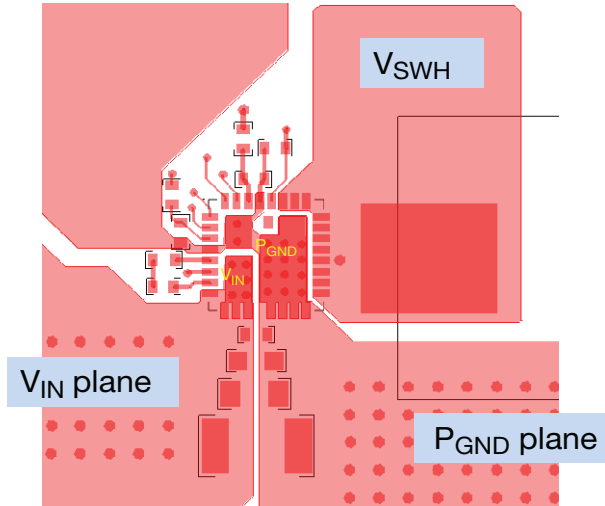
**PCB LAYOUT RECOMMENDATIONS**
**Step 1:  $V_{IN}$ /GND Planes and Decoupling**

1. Layout  $V_{IN}$  and  $P_{GND}$  planes as shown above
2. Ceramic capacitors should be placed right between  $V_{IN}$  and  $P_{GND}$ , and very close to the device for best decoupling effect
3. Difference values / packages of ceramic capacitors should be used to cover entire decoupling spectrum e.g. 1210, 0805, 0603 and 0402
4. Smaller capacitance value, closer to device  $V_{IN}$  pin(s) - better high frequency noise absorbing

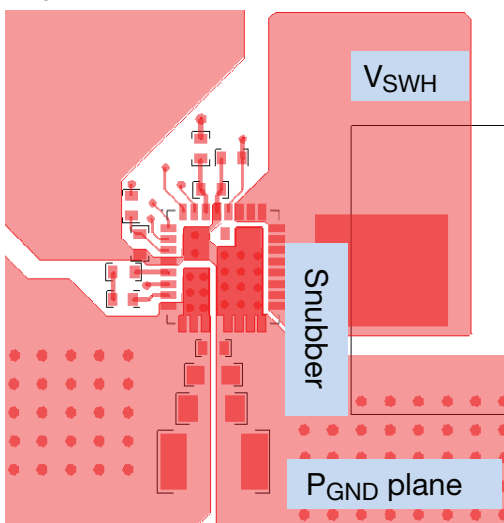
**Step 2:  $V_{SWH}$  Plane**

1. Connect output inductor to DrMOS with large plane to lower the resistance
2. If any snubber network is required, place the components as shown above and the network can be placed at bottom

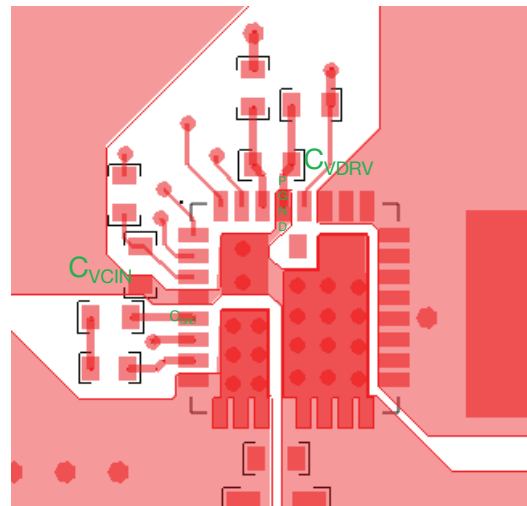
**Step 3:  $V_{CIN}/V_{DRV}$  Input Filter**

1. The  $V_{CIN}/V_{DRV}$  input filter ceramic cap should be placed very close to IC. It is recommended to connect two caps separately
2.  $C_{VCIN}$  cap should be placed between pin 3 and pin 4 ( $C_{GND}$  of driver IC) to achieve best noise filtering
3.  $C_{VDRV}$  cap should be placed between pin 28 ( $P_{GND}$  of driver IC) and pin 29 to provide maximum instantaneous driver current for low-side MOSFET during switching cycle
4. For connecting  $C_{VCIN}$  analog ground, it is recommended to use large plane to reduce parasitic inductance

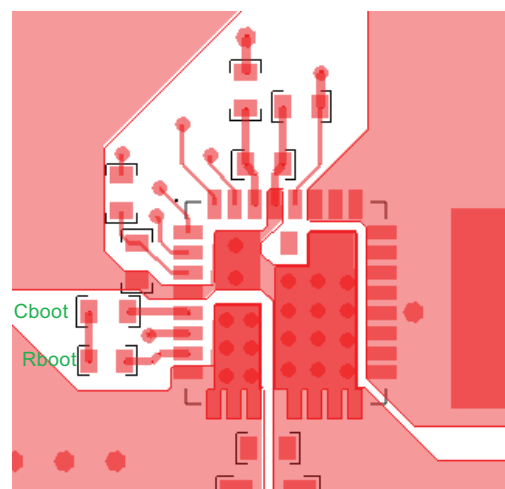
**Step 4: BOOT Resistor and Capacitor Placement**

1. These components need to be placed very close to IC, right between PHASE (pin 7) and BOOT (pin 5)
2. To reduce parasitic inductance, chip size 0402 can be used

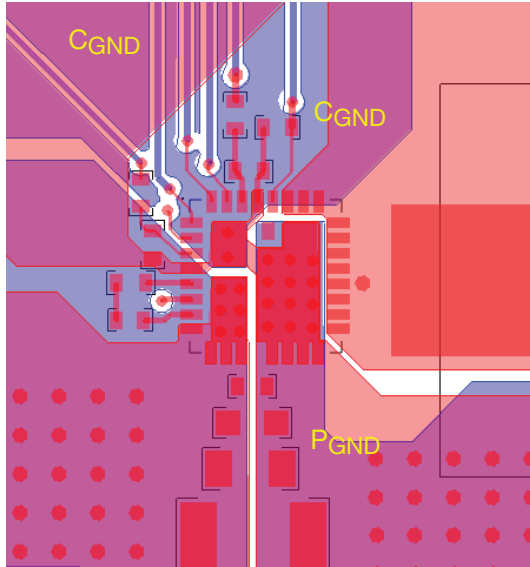
**Step 5: Signal Routing**

1. Route the PWM / ZCD\_EN# / DSBL# / THWn signal traces out of the top left corner next DrMOS pin 1
2. PWM signal is very important signal, both signal and return traces need to pay special attention of not letting this trace cross any power nodes on any layer
3. It is best to “shield” traces from power switching nodes, e.g. V<sub>SWH</sub>, to improve signal integrity
4. GL (pin 27) has been connected with GL pad internally and does not need to connect externally

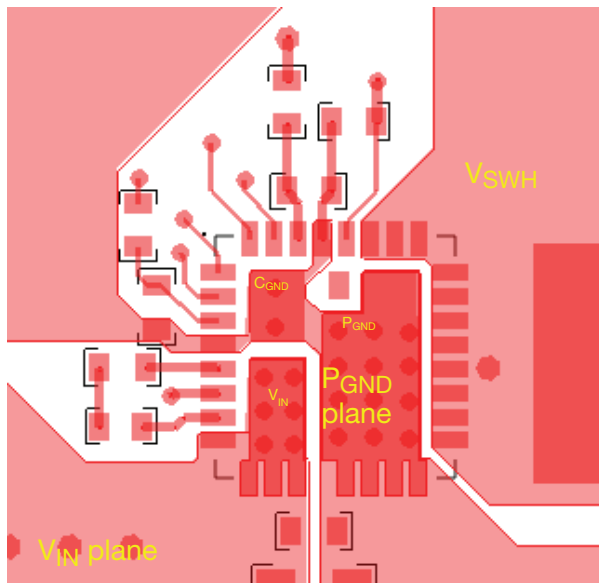
**Step 6: Adding Thermal Relief Vias**

1. Thermal relief vias can be added on the V<sub>IN</sub> and P<sub>GND</sub> pads to utilize inner layers for high-current and thermal dissipation
2. To achieve better thermal performance, additional vias can be put on V<sub>IN</sub> plane and P<sub>GND</sub> plane
3. V<sub>SWH</sub> pad is a noise source and not recommended to put vias on this plane
4. 8 mil drill for pads and 10 mils drill for plane can be the optional via size. Vias on pad may drain solder during assembly and cause assembly issue. Please consult with the assembly house for guideline

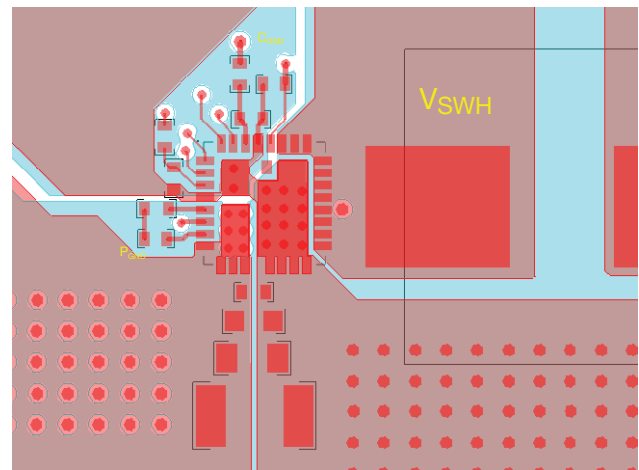
**Step 7: Ground Connection**

1. It is recommended to make single connection between C<sub>GND</sub> and P<sub>GND</sub> and this connection can be done on top layer.
2. It is recommended to make the whole inner 1 layer (next to top layer) ground plane and separate them into C<sub>GND</sub> and P<sub>GND</sub> plane
3. These ground planes provide shielding between noise source on top layer and signal trace on bottom layer

**Multi-Phases VRPower PCB Layout**

Following is an example for 6 phase layout. As can be seen, all the VRPower stages are lined in X-direction compactly with decoupling caps next to them. The inductors are placed as close as possible to the SiC620 and SiC620A to minimize the PCB copper loss. Vias are applied on all PADs ( $V_{IN}$ ,  $P_{GND}$ ,  $C_{GND}$ ) of the SiC620 and SiC620A to ensure that both electrical and thermal performance are excellent. Large copper planes are used for all the high current loops, such as  $V_{IN}$ ,  $V_{SWH}$ ,  $V_{OUT}$  and  $P_{GND}$ . These copper planes are duplicated in other layers to minimize the inductance and resistance. All the control signals are routed from the SiC620 and SiC620A to a controller placed to the north of the power stage through inner layers to avoid the overlap of high current loops. This achieves a compact design with the output from the inductors feeding a load located to the south of the design as shown in the figure.

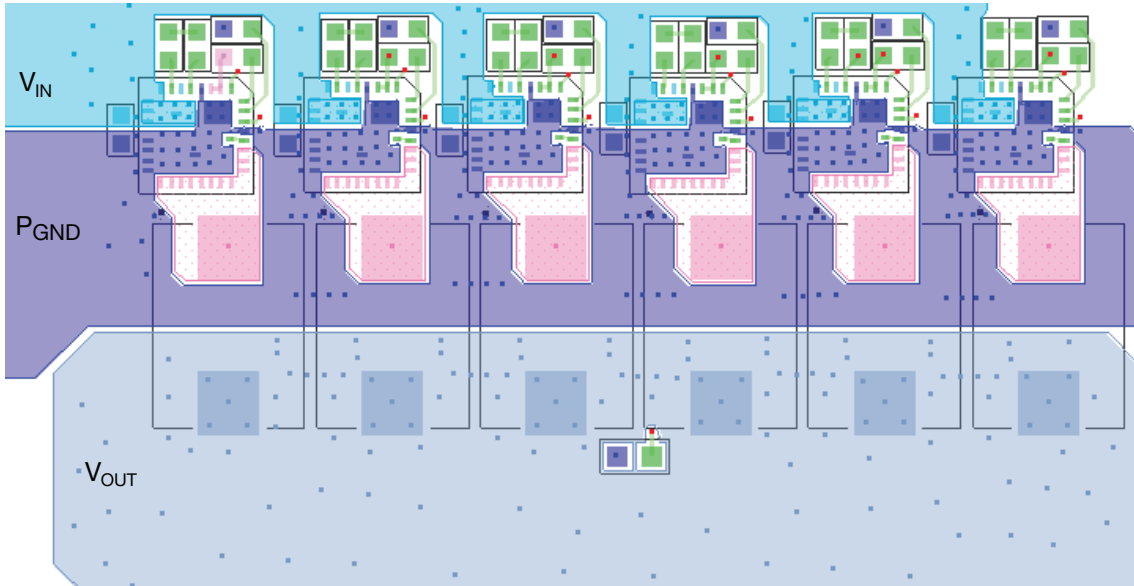
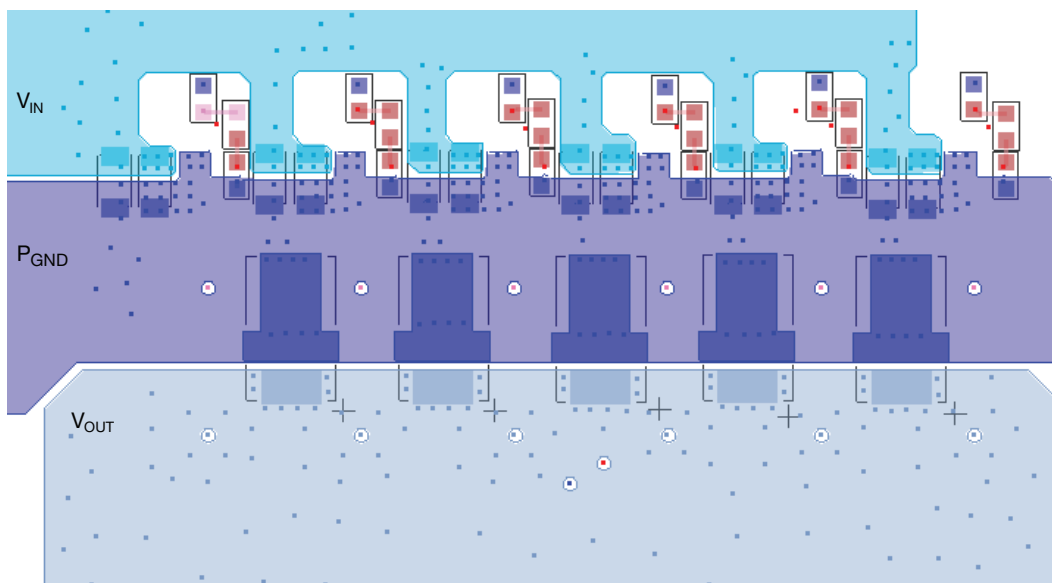
**Fig. 29 - Multi-Phase VRPower Layout Top View**

**Fig. 30 - Multi-Phase VRPower Layout Bottom View**

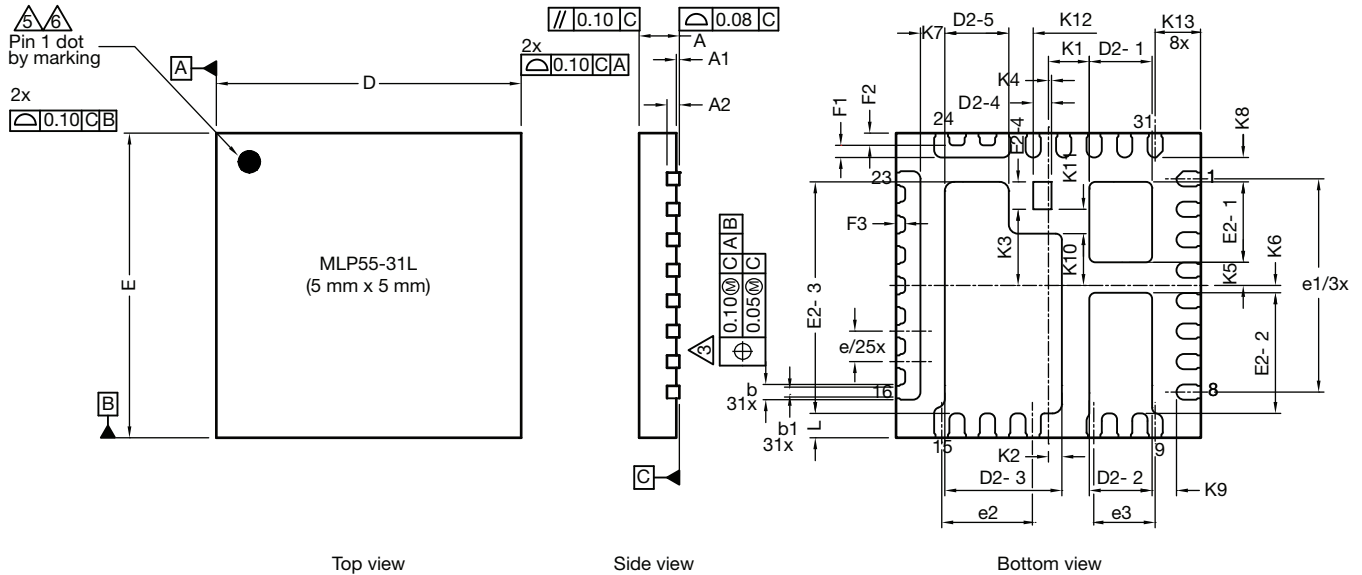

PRODUCT SUMMARY		
Part number	SiC620	SiC620A
Description	60 A power stage, 4.5 V <sub>IN</sub> to 18 V <sub>IN</sub> , 5 V PWM with ZCD mode	60 A power stage, 4.5 V <sub>IN</sub> to 18 V <sub>IN</sub> , 3.3 V PWM with ZCD mode
Input voltage min. (V)	4.5	4.5
Input voltage max. (V)	18	18
Continuous current rating max. (A)	60	60
Switch frequency max. (kHz)	1500	1500
Enable (yes / no)	Yes	Yes
Monitoring features	-	-
Protection	UVLO, THDN	UVLO, THDN
Light load mode	ZCD	ZCD
Pulse-width modulation (V)	5	3.3
Package type	PowerPAK MLP55-31L	PowerPAK MLP55-31L
Package size (W, L, H) (mm)	5.0 x 5.0 x 0.75	5.0 x 5.0 x 0.75
Status code	2	2
Product type	VRPower (DrMOS)	VRPower (DrMOS)
Applications	Computer, industrial, networking	Computer, industrial, networking

Vishay Siliconix maintains worldwide manufacturing capability. Products may be manufactured at one of several qualified locations. Reliability data for Silicon Technology and Package Reliability represent a composite of all qualified locations. For related documents such as package / tape drawings, part marking, and reliability data, see [www.vishay.com/ppg?62922](http://www.vishay.com/ppg?62922).

**PowerPAK® MLP55-31L Case Outline**

DIM.	MILLIMETERS			INCHES		
	MIN.	NOM.	MAX.	MIN.	NOM.	MAX.
A	0.70	0.75	0.80	0.027	0.029	0.031
A1	0.00	-	0.05	0.000	-	0.002
A2	0.20 ref.			0.008 ref.		
b	0.20	0.25	0.30	0.078	0.098	0.011
b1	0.15	0.20	0.25	0.006	0.008	0.010
D	4.90	5.00	5.10	0.193	0.196	0.200
e	0.50 BSC			0.019 BSC		
e1	3.50 BSC			0.138 BSC		
e2	1.50 BSC			0.060 BSC		
e3	1.00 BSC			0.040 BSC		
E	4.90	5.00	5.10	0.193	0.196	0.200
L	0.35	0.40	0.45	0.013	0.015	0.017
D2-1	0.98	1.03	1.08	0.039	0.041	0.043
D2-2	0.98	1.03	1.08	0.039	0.041	0.043
D2-3	1.87	1.92	1.97	0.074	0.076	0.078
D2-4	0.30 BSC			0.012 BSC		
D2-5	1.05	1.10	1.15	0.041	0.043	0.045
E2-1	1.27	1.32	1.37	0.050	0.052	0.054
E2-2	1.93	1.98	2.03	0.076	0.078	0.080
E2-3	3.75	3.80	3.85	0.148	0.150	0.152
E2-4	0.45 BSC			0.018 BSC		
F1	0.15	0.20	0.25	0.006	0.008	0.010
F2	0.20 ref.			0.008 ref.		
F3	0.15 ref.			0.006 ref.		





DIM.	MILLIMETERS			INCHES		
	MIN.	NOM.	MAX.	MIN.	NOM.	MAX.
K1		0.67 BSC			0.026 BSC	
K2		0.22 BSC			0.008 BSC	
K3		1.25 BSC			0.049 BSC	
K4		0.10 BSC			0.004 BSC	
K5		0.38 BSC			0.015 BSC	
K6		0.12 BSC			0.005 BSC	
K7		0.40 BSC			0.016 BSC	
K8		0.40 BSC			0.016 BSC	
K9		0.40 BSC			0.016 BSC	
K10		0.85 BSC			0.033 BSC	
K11		0.40 BSC			0.016 BSC	
K12		0.40 BSC			0.016 BSC	
K13		0.75 BSC			0.030 BSC	
ECN: T17-0423-Rev. F, 21-Aug-17 DWG: 6025						

### Notes

1. Use millimeters as the primary measurement
2. Dimensioning and tolerances conform to ASME Y14.5M. - 1994
3. Dimension b applies to plated terminal and is measured between 0.20 mm and 0.25 mm from terminal tip
4. The pin #1 identifier must be existed on the top surface of the package by using indentation mark or other feature of package body
5. Exact shape and size of this feature is optional
6. Package warpage max. 0.08 mm
7. Applied only for terminals



# Recommended Land Pattern PowerPAK<sup>®</sup> MLP55-31L

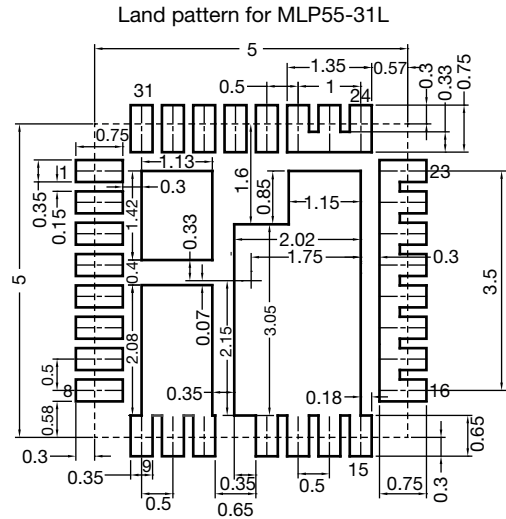
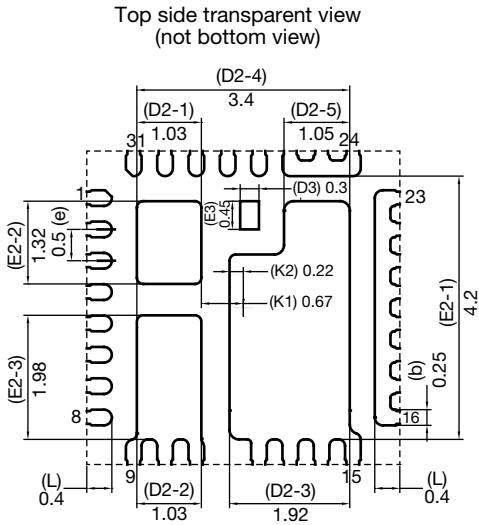

All dimensions in millimeters

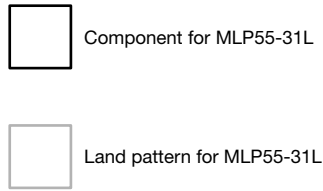
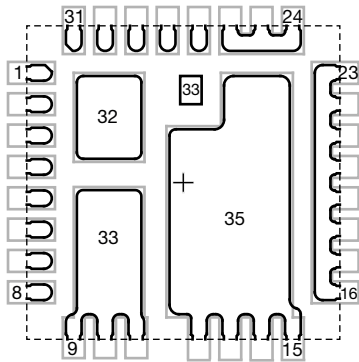



## **Disclaimer**

ALL PRODUCT, PRODUCT SPECIFICATIONS AND DATA ARE SUBJECT TO CHANGE WITHOUT NOTICE TO IMPROVE RELIABILITY, FUNCTION OR DESIGN OR OTHERWISE.

Vishay Intertechnology, Inc., its affiliates, agents, and employees, and all persons acting on its or their behalf (collectively, "Vishay"), disclaim any and all liability for any errors, inaccuracies or incompleteness contained in any datasheet or in any other disclosure relating to any product.

Vishay makes no warranty, representation or guarantee regarding the suitability of the products for any particular purpose or the continuing production of any product. To the maximum extent permitted by applicable law, Vishay disclaims (i) any and all liability arising out of the application or use of any product, (ii) any and all liability, including without limitation special, consequential or incidental damages, and (iii) any and all implied warranties, including warranties of fitness for particular purpose, non-infringement and merchantability.

Statements regarding the suitability of products for certain types of applications are based on Vishay's knowledge of typical requirements that are often placed on Vishay products in generic applications. Such statements are not binding statements about the suitability of products for a particular application. It is the customer's responsibility to validate that a particular product with the properties described in the product specification is suitable for use in a particular application. Parameters provided in datasheets and / or specifications may vary in different applications and performance may vary over time. All operating parameters, including typical parameters, must be validated for each customer application by the customer's technical experts. Product specifications do not expand or otherwise modify Vishay's terms and conditions of purchase, including but not limited to the warranty expressed therein.

Hyperlinks included in this datasheet may direct users to third-party websites. These links are provided as a convenience and for informational purposes only. Inclusion of these hyperlinks does not constitute an endorsement or an approval by Vishay of any of the products, services or opinions of the corporation, organization or individual associated with the third-party website. Vishay disclaims any and all liability and bears no responsibility for the accuracy, legality or content of the third-party website or for that of subsequent links.

Except as expressly indicated in writing, Vishay products are not designed for use in medical, life-saving, or life-sustaining applications or for any other application in which the failure of the Vishay product could result in personal injury or death. Customers using or selling Vishay products not expressly indicated for use in such applications do so at their own risk. Please contact authorized Vishay personnel to obtain written terms and conditions regarding products designed for such applications.

No license, express or implied, by estoppel or otherwise, to any intellectual property rights is granted by this document or by any conduct of Vishay. Product names and markings noted herein may be trademarks of their respective owners.