

## EMERALD-A

Asymmetric beam

### TECHNICAL SPECIFICATIONS:

Dimensions	Ø 21.6 mm
Height	6.9 mm
Fastening	glue, pin
ROHS compliant	yes ⓘ

### MATERIAL SPECIFICATIONS:

Component	Type	Material	Colour	Finish
EMERALD-A	Single lens	PMMA	clear	

### ORDERING INFORMATION:

Component	Qty in box	MOQ	MPQ	Box weight (kg)
C13155_EMERALD-A » Box size: 480 x 280 x 300 mm	2128	336	112	4.8



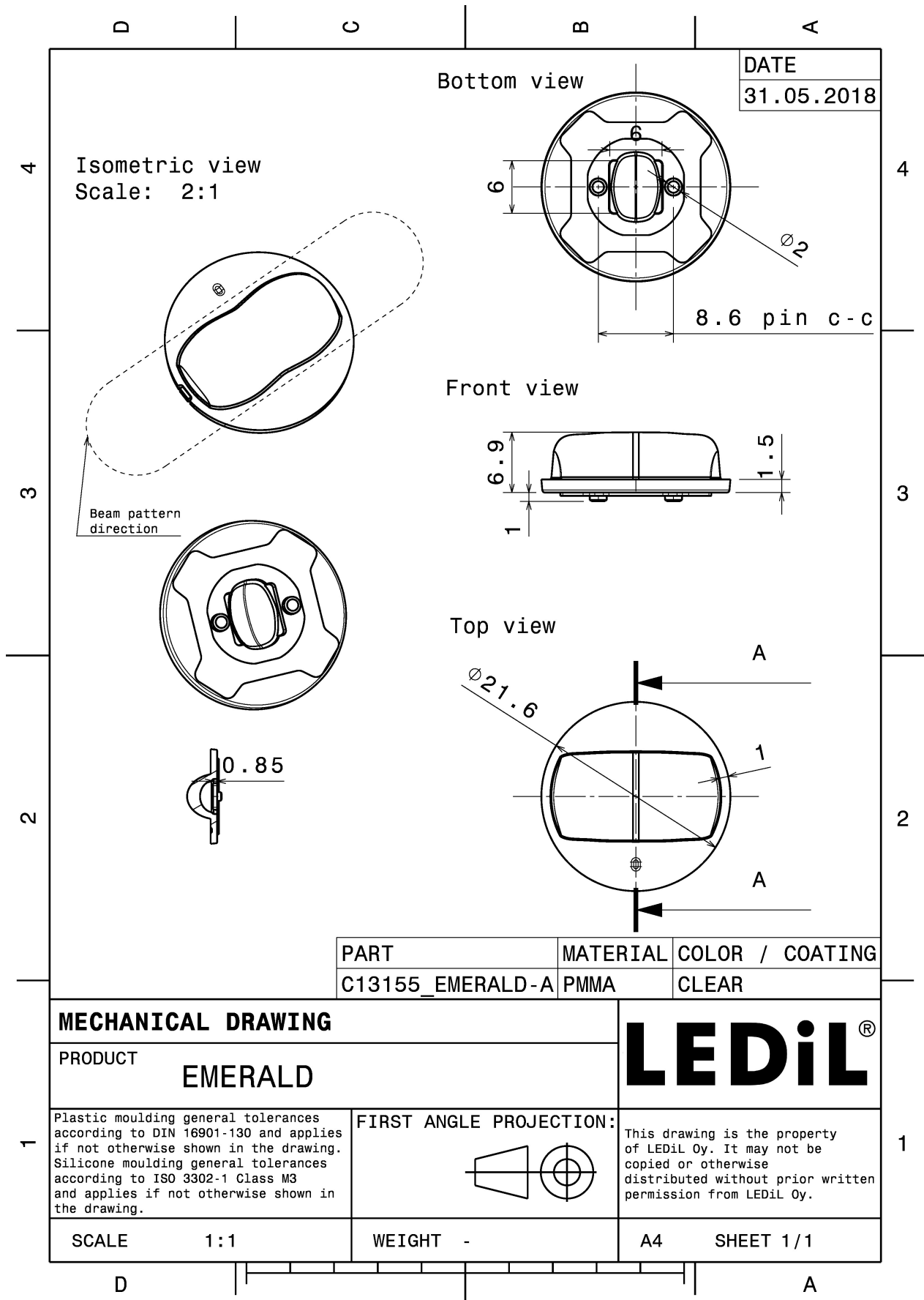

See also our general installation guide: [www.ledil.com/installation\\_guide](http://www.ledil.com/installation_guide)

### PHOTOMETRIC DATA (MEASURED):

#### CREE LED

LED XB-D  
 FWHM / FWTM 157.0 + 62.0°  
 Efficiency 90 %  
 Peak intensity 2 cd/lm  
 LEDs/each optic 1  
 Light colour White  
 Required components:

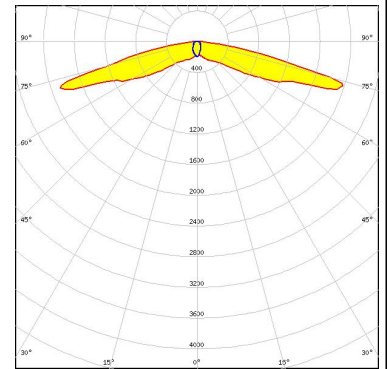

#### CREE LED

LED XM-L  
 FWHM / FWTM 157.0 + 83.0°  
 Efficiency 94 %  
 Peak intensity 1.1 cd/lm  
 LEDs/each optic 1  
 Light colour White  
 Required components:

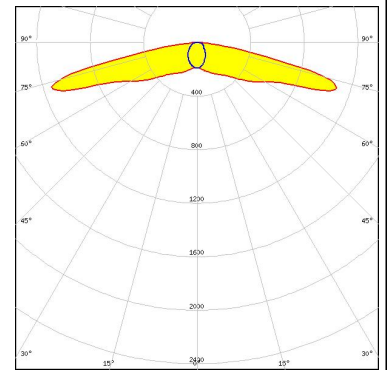

#### CREE LED

LED XM-L2  
 FWHM / FWTM 169.0 + 73.0°  
 Efficiency 94 %  
 Peak intensity 1.1 cd/lm  
 LEDs/each optic 1  
 Light colour White  
 Required components:

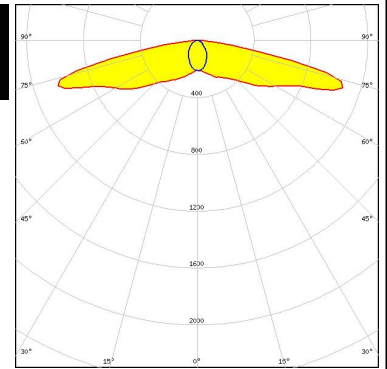

#### CREE LED

LED XP-E  
 FWHM / FWTM 158.0 + 73.0°  
 Efficiency 93 %  
 Peak intensity 2.3 cd/lm  
 LEDs/each optic 1  
 Light colour White  
 Required components:

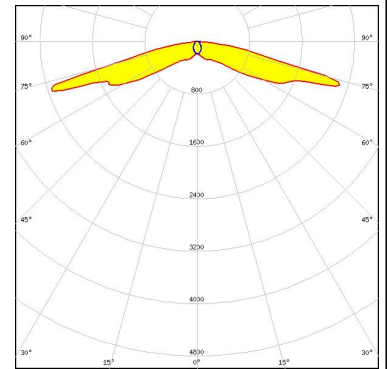

### PHOTOMETRIC DATA (MEASURED):

#### CREE LED

LED XP-E2  
 FWHM / FWTM 156.0 + 72.0°  
 Efficiency 93 %  
 Peak intensity 2.5 cd/lm  
 LEDs/each optic 1  
 Light colour White  
 Required components:

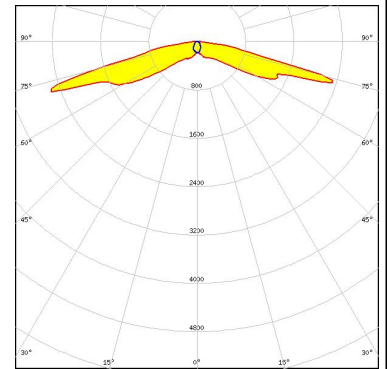

#### CREE LED

LED XP-G  
 FWHM / FWTM 159.0 + 79.0°  
 Efficiency 89 %  
 Peak intensity 1.6 cd/lm  
 LEDs/each optic 1  
 Light colour White  
 Required components:

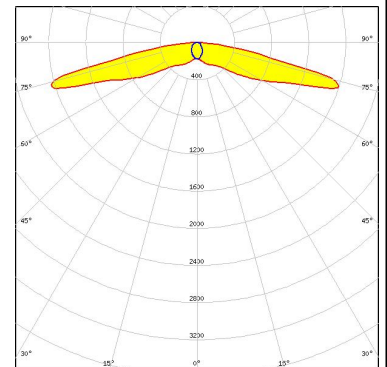

#### CREE LED

LED XP-G2  
 FWHM / FWTM 158.0 + 79.0°  
 Efficiency 94 %  
 Peak intensity 1.8 cd/lm  
 LEDs/each optic 1  
 Light colour White  
 Required components:

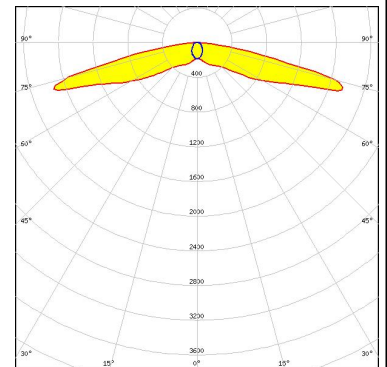

#### CREE LED

LED XT-E  
 FWHM / FWTM 157.0 + 61.0°  
 Efficiency 89 %  
 Peak intensity 1.8 cd/lm  
 LEDs/each optic 1  
 Light colour White  
 Required components:

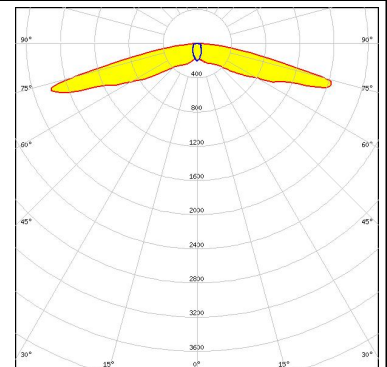

### PHOTOMETRIC DATA (MEASURED):

#### LUMILEDS

LED LUXEON A  
 FWHM / FWTM 156.0 + 75.0°  
 Efficiency 92 %  
 Peak intensity 1.6 cd/lm  
 LEDs/each optic 1  
 Light colour White  
 Required components:

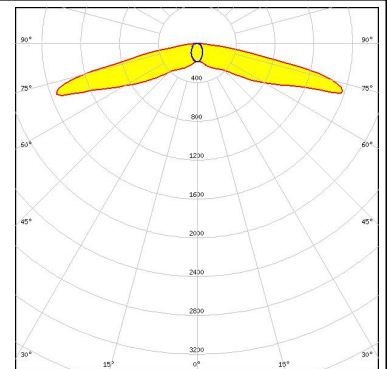

#### LUMILEDS

LED LUXEON R  
 FWHM / FWTM 153.0 + 73.0°  
 Efficiency 92 %  
 Peak intensity 1.7 cd/lm  
 LEDs/each optic 1  
 Light colour White  
 Required components:

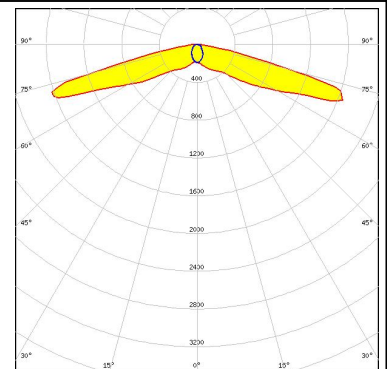

#### LUMILEDS

LED LUXEON Rebel  
 FWHM / FWTM 152.0 + 67.0°  
 Efficiency 92 %  
 Peak intensity 2.5 cd/lm  
 LEDs/each optic 1  
 Light colour White  
 Required components:

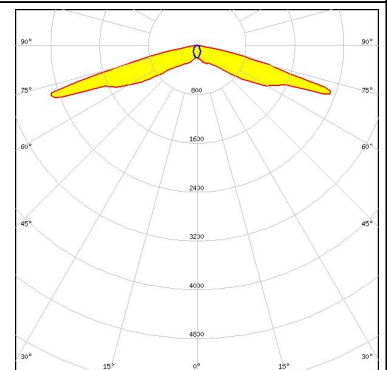

#### LUMILEDS

LED LUXEON Rebel ES  
 FWHM / FWTM 153.0 + 74.0°  
 Efficiency 90 %  
 Peak intensity 1.7 cd/lm  
 LEDs/each optic 1  
 Light colour White  
 Required components:

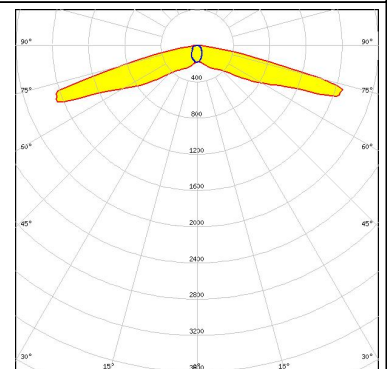

### PHOTOMETRIC DATA (MEASURED):

#### LUMILEDS

LED LUXEON T  
 FWHM / FWTM 155.0 + 76.0°  
 Efficiency 93 %  
 Peak intensity 2.3 cd/lm  
 LEDs/each optic 1  
 Light colour White  
 Required components:

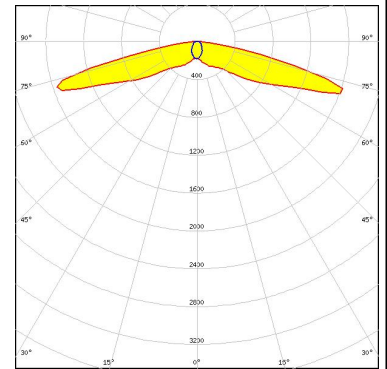

#### LUMILEDS

LED LUXEON TX  
 FWHM / FWTM 156.0 + 73.0°  
 Efficiency 94 %  
 Peak intensity 1.7 cd/lm  
 LEDs/each optic 1  
 Light colour White  
 Required components:

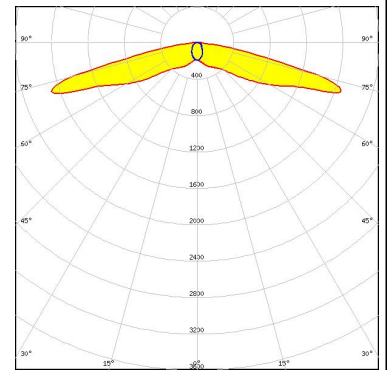

#### NICHIA

LED NCSxx19A  
 FWHM / FWTM 151.0 + 65.0°  
 Efficiency 92 %  
 Peak intensity 2.2 cd/lm  
 LEDs/each optic 1  
 Light colour White  
 Required components:

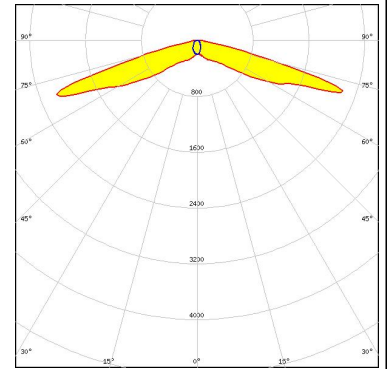

#### NICHIA

LED NVSxx19A  
 FWHM / FWTM 153.0 + 71.0°  
 Efficiency 91 %  
 Peak intensity 1.7 cd/lm  
 LEDs/each optic 1  
 Light colour White  
 Required components:

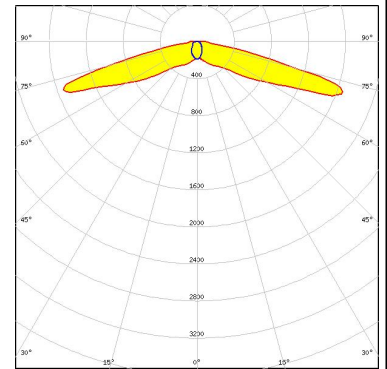

### PHOTOMETRIC DATA (MEASURED):

<p><b>NICHIA</b></p> <p>LED NVSxx19B/NVSxx19C            FWHM / FWTM 155.0 + 80.0° / 168.0 + 158.0°            Efficiency 92 %            Peak intensity 1.4 cd/lm            LEDs/each optic 1            Light colour White            Required components:</p>	
<p><b>OSRAM</b> Opto Semiconductors</p> <p>LED OSLOM Square EC            FWHM / FWTM 156.0 + 80.0°            Efficiency 93 %            Peak intensity 1.7 cd/lm            LEDs/each optic 1            Light colour White            Required components:</p>	
<p><b>OSRAM</b> Opto Semiconductors</p> <p>LED OSLOM Square PC            FWHM / FWTM 156.0 + 83.0°            Efficiency 93 %            Peak intensity 1.7 cd/lm            LEDs/each optic 1            Light colour White            Required components:</p>	
<p><b>OSRAM</b> Opto Semiconductors</p> <p>LED OSLOM SSL 150            FWHM / FWTM 157.0 + 86.0°            Efficiency 92 %            Peak intensity 2.9 cd/lm            LEDs/each optic 1            Light colour White            Required components:</p>	

### PHOTOMETRIC DATA (MEASURED):

#### OSRAM

Opto Semiconductors

LED OSLON SSL 80  
FWHM / FWTM 147.0 + 52.0°  
Efficiency 89 %  
Peak intensity 1.9 cd/lm  
LEDs/each optic 1  
Light colour White  
Required components:

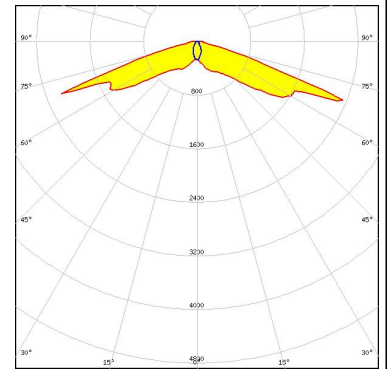

#### SAMSUNG

LED LH351Z  
FWHM / FWTM 154.0 + 76.0°  
Efficiency 94 %  
Peak intensity 1.7 cd/lm  
LEDs/each optic 1  
Light colour White  
Required components:

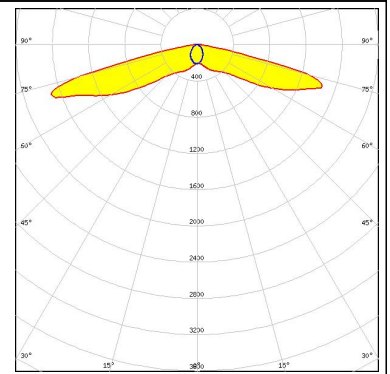



### PHOTOMETRIC DATA (SIMULATED):



LED XHP35 HD  
 FWHM / FWTM 164.0 + 68.0°  
 Efficiency 91 %  
 Peak intensity 0.8 cd/lm  
 LEDs/each optic 1  
 Light colour White  
 Required components:

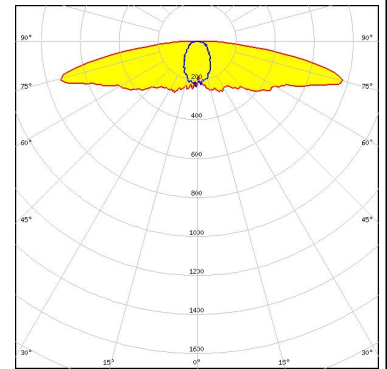

LED XHP35 HI  
 FWHM / FWTM 162.0 + 51.0° / 176.0 + 146.0°  
 Efficiency 90 %  
 Peak intensity 0.9 cd/lm  
 LEDs/each optic 1  
 Light colour White  
 Required components:

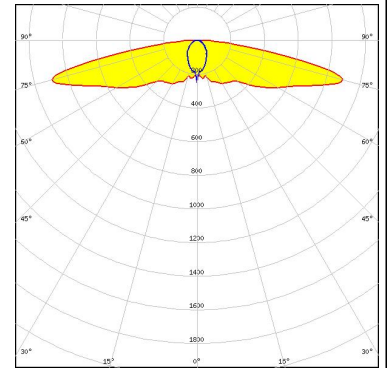

LED XP-L HI  
 FWHM / FWTM 159.0°  
 Efficiency 89 %  
 Peak intensity 1.3 cd/lm  
 LEDs/each optic 1  
 Light colour White  
 Required components:

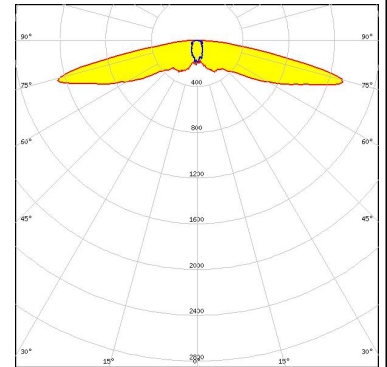

LED NF2W757G-MT (Tunable White)  
 FWHM / FWTM 159.0 + 59.0° / 172.0 + 158.0°  
 Efficiency 94 %  
 Peak intensity 1.1 cd/lm  
 LEDs/each optic 1  
 Light colour Tunable White  
 Required components:

### PHOTOMETRIC DATA (SIMULATED):

#### OSRAM

Opto Semiconductors

LED OSLON Square CSSRM2/CSSRM3  
FWHM / FWTM 158.0 + 70.0°  
Efficiency 93 %  
Peak intensity 1.5 cd/lm  
LEDs/each optic 1  
Light colour White  
Required components:

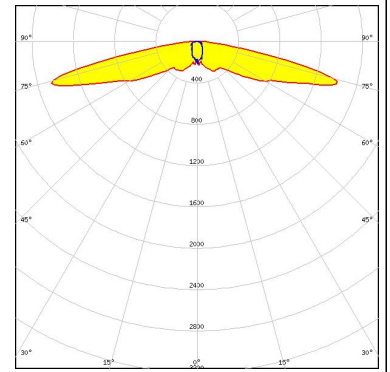

#### SAMSUNG

LED LH351D  
FWHM / FWTM 86.0 + 164.0° / 166.0 + 176.0°  
Efficiency 91 %  
Peak intensity 0.7 cd/lm  
LEDs/each optic 1  
Light colour White  
Required components:

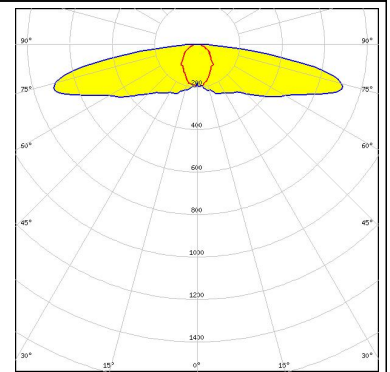

### GENERAL INFORMATION:

NOTE: The typical beam angle will be changed by different color, chip size and chip position tolerance. The typical total beam angle is the full angle measured where the luminous intensity is half of the peak value.

### MATERIALS:

As part of our continuous research and improvement processes, and to ensure the best possible quality and availability of our products, LEDiL reserves the right to change material grades without notice.

### PRODUCT DATA USER AGREEMENT AND DISCLAIMER:

The measured data in the provided downloadable LEDiL Product Datasheets and Mechanical 2D-Drawings is rounded and provided as reference for planning. LEDiL Oy's optical specifications have been verified by conducting performance testing of the products in accordance with the company's quality system. The reported data are averaged results of multiple measurements with typical variation. LEDiL Oy reserves the right to without prior notification make changes and improvements to its products.

LEDiL Oy assumes neither warranty, nor guarantee nor any other liability of any kind for the contents and correctness of the provided data. The provided data has been generated with highest diligence but the provided data may in reality not represent the complete possible variation range of all intrinsic parameters. Therefore, in certain cases a deviation from the provided data could occur.

LEDiL Oy reserves the right to undertake technical changes of its products without further notification which could lead to changes in the provided data. LEDiL Oy assumes no liability of any kind for the possible deviation from any provided data or any other damage resulting from the usage of the provided data.

The user agrees to this disclaimer and user agreement with the download or usage of the provided files.

#### LEDiL Oy

Joensuunkatu 13  
FI-24240 SALO  
Finland

#### LEDiL Inc.

228 West Page Street  
Suite D  
Sycamore IL 60178  
USA

#### Ledil Optics Technology (Shenzhen) Co., Ltd.

# 405 , Block B  
Casic Motor Building  
Shenzhen 518057  
P.R.CHINA

#### Local sales and technical support

[www.ledil.com/  
where\\_to\\_buy](http://www.ledil.com/where_to_buy)

#### Shipping locations

Salo, Finland  
Hong Kong, China

#### Distribution Partners

[www.ledil.com/  
where\\_to\\_buy](http://www.ledil.com/where_to_buy)