

MIRELLA-50-S-PF

~15° spot beam

TECHNICAL SPECIFICATIONS:

Dimensions	Ø 49.9 mm
Height	24 mm
Fastening	socket
ROHS compliant	yes ⓘ

MATERIAL SPECIFICATIONS:

Component	Type	Material	Colour	Finish	Coating
MIRELLA-50-S-PF	Reflector	PC	metal		lacquer

ORDERING INFORMATION:





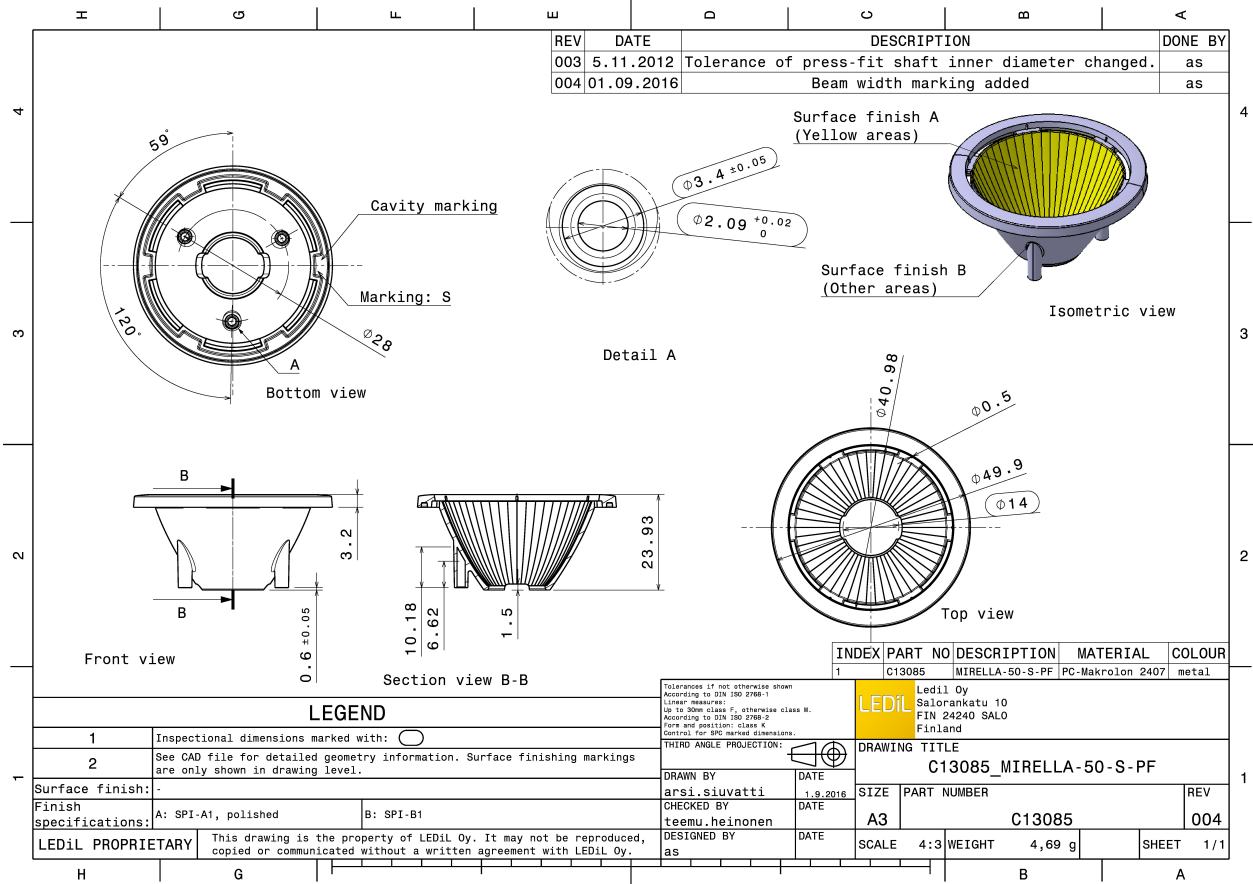



Component	Qty in box	MOQ	MPQ	Box weight (kg)
C13085_MIRELLA-50-S-PF » Box size: 480 x 280 x 300 mm	336	112	28	3.0



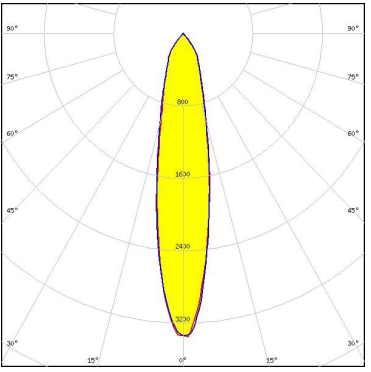

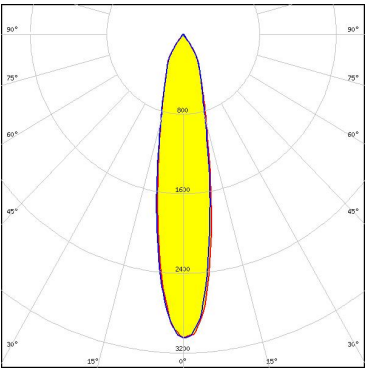

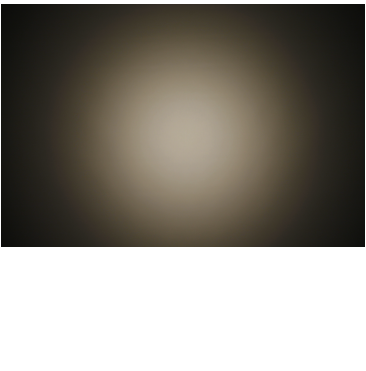
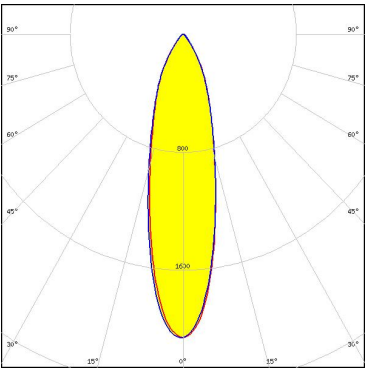

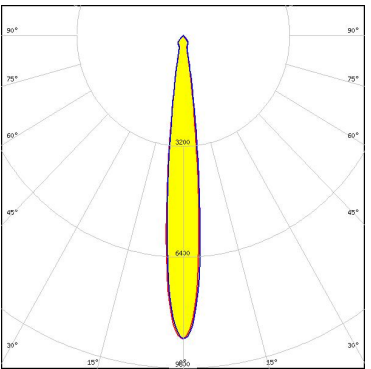

See also our general installation guide: www.ledil.com/installation_guide

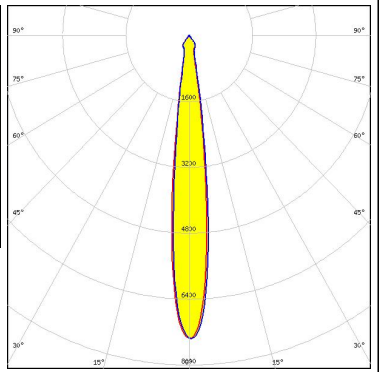

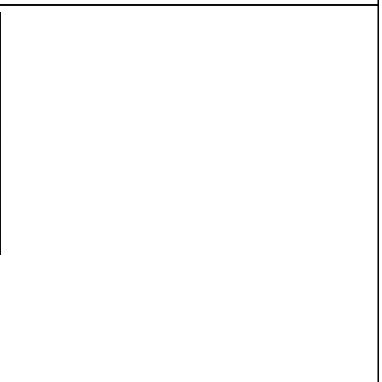

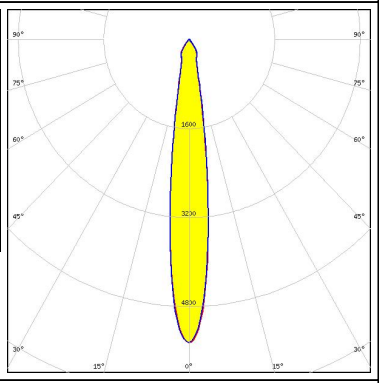

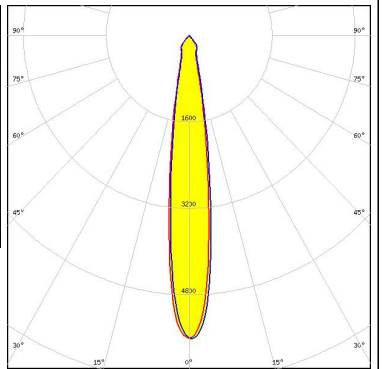

PHOTOMETRIC DATA (MEASURED):

<p></p> <p>LED V10 Gen7 FWHM / FWTM 21.0° / 61.0° Efficiency 91 % Peak intensity 3.4 cd/lm LEDs/each optic 1 Light colour White</p> <p>Required components: C13709_PF-SOCKET-VERO13-18 Bender Wirth: 486 Typ L1</p>		
<p></p> <p>LED V10 Gen7 FWHM / FWTM 21.0° / 61.0° Efficiency 81 % Peak intensity 3.1 cd/lm LEDs/each optic 1 Light colour White</p> <p>Required components: C13709_PF-SOCKET-VERO13-18 C13333_MIRELLA-CL</p>		
<p></p> <p>LED V10 Gen7 FWHM / FWTM 26.0° / 66.0° Efficiency 79 % Peak intensity 2.1 cd/lm LEDs/each optic 1 Light colour White</p> <p>Required components: C13709_PF-SOCKET-VERO13-18 C12479_MIRELLA-DL</p>		
<p></p> <p>LED V6 Gen6 FWHM / FWTM 12.0° / 25.0° Efficiency 90 % Peak intensity 8.8 cd/lm LEDs/each optic 1 Light colour White</p> <p>Required components: C13761_PF-SOCKET-CXA15</p>		

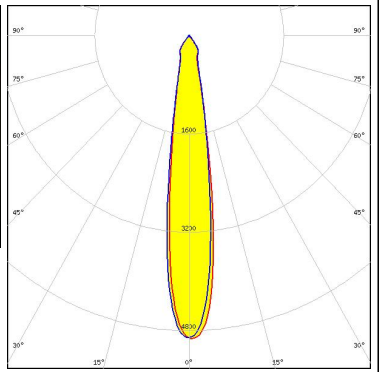
PHOTOMETRIC DATA (MEASURED):

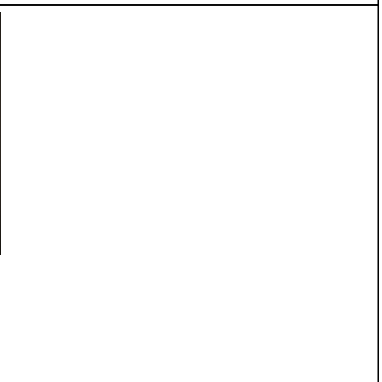
<p>bridgelux.</p> <p>LED V6 Gen6 FWHM / FWTM 13.0° / 26.0° Efficiency 84 % Peak intensity 7.4 cd/m LEDs/each optic 1 Light colour White</p> <p>Required components: C13761_PF-SOCKET-CXA15 C13333_MIRELLA-CL</p>		
<p>bridgelux.</p> <p>LED V6 Gen6 FWHM / FWTM 18.0° / 52.0° Efficiency 73 % Peak intensity 4.3 cd/m LEDs/each optic 1 Light colour White</p> <p>Required components: C13709_PF-SOCKET-VERO13-18 C12479_MIRELLA-DL Bender Wirth: 460 Typ L1</p>		
<p>bridgelux.</p> <p>LED V6 Gen6 FWHM / FWTM 15.0° / 33.0° Efficiency 84 % Peak intensity 5.5 cd/m LEDs/each optic 1 Light colour White</p> <p>Required components: C13761_PF-SOCKET-CXA15 C12479_MIRELLA-DL</p>		
<p>bridgelux.</p> <p>LED V8 Gen6 FWHM / FWTM 15.0° / 34.0° Efficiency 90 % Peak intensity 5.6 cd/m LEDs/each optic 1 Light colour White</p> <p>Required components: C13761_PF-SOCKET-CXA15</p>		

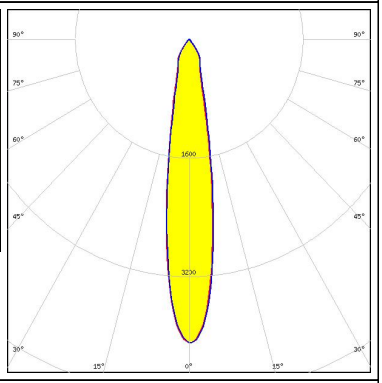
PHOTOMETRIC DATA (MEASURED):

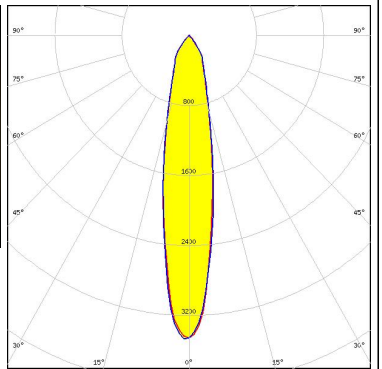
<p></p> <p>LED V8 Gen6 FWHM / FWTM 16.0° / 36.0° Efficiency 84 % Peak intensity 4.9 cd/m LEDs/each optic 1 Light colour White</p> <p>Required components: C13761_PF-SOCKET-CXA15 C13333_MIRELLA-CL</p>		
<p></p> <p>LED V8 Gen6 FWHM / FWTM 20.0° / 62.0° Efficiency 71 % Peak intensity 3.4 cd/m LEDs/each optic 1 Light colour White</p> <p>Required components: C13709_PF-SOCKET-VERO13-18 C12479_MIRELLA-DL Bender Wirth: 460 Typ L1</p>		
<p></p> <p>LED V8 Gen6 FWHM / FWTM 18.0° / 44.0° Efficiency 85 % Peak intensity 4.1 cd/m LEDs/each optic 1 Light colour White</p> <p>Required components: C13761_PF-SOCKET-CXA15 C12479_MIRELLA-DL</p>		
<p></p> <p>LED VERO10 FWHM / FWTM 20.0° / 57.0° Efficiency 88 % Peak intensity 3.5 cd/m LEDs/each optic 1 Light colour White</p> <p>Required components: C13708_PF-SOCKET-VERO10</p>		

PHOTOMETRIC DATA (MEASURED):

bridgelux.

LED VERO10
 FWHM / FWTM 23.0° / 63.0°
 Efficiency 83 %
 Peak intensity 2.6 cd/m
 LEDs/each optic 1
 Light colour White
 Required components:
 C13708_PF-SOCKET-VERO10
 C13333_MIRELLA-CL

bridgelux.

LED VERO10
 FWHM / FWTM 23.0° / 63.0°
 Efficiency 83 %
 Peak intensity 2.6 cd/m
 LEDs/each optic 1
 Light colour White
 Required components:
 C13708_PF-SOCKET-VERO10
 C12479_MIRELLA-DL

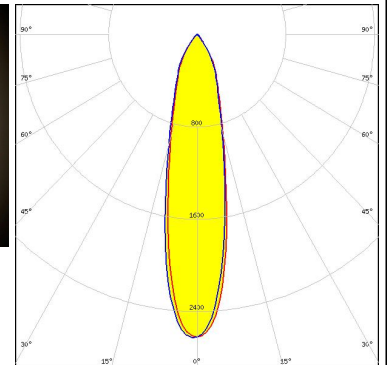
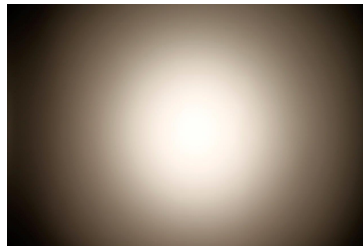

bridgelux.

LED VERO13
 FWHM / FWTM 25.0° / 69.0°
 Efficiency 89 %
 Peak intensity 2.5 cd/m
 LEDs/each optic 1
 Light colour White
 Required components:
 C13709_PF-SOCKET-VERO13-18

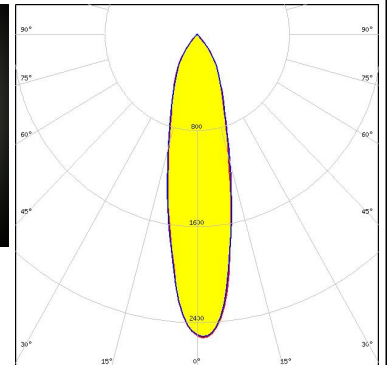
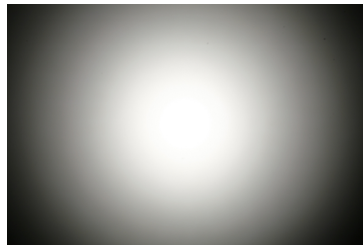





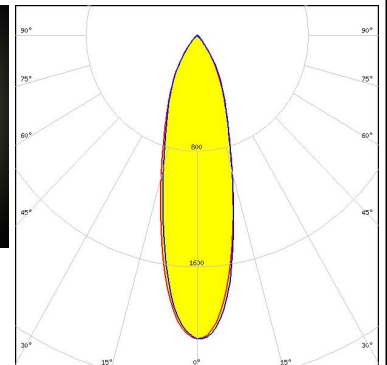
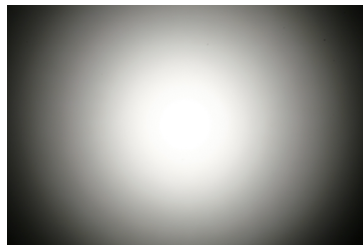

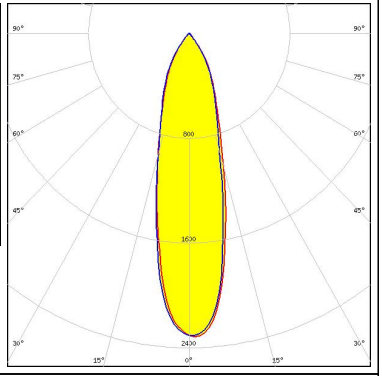

bridgelux.

LED VERO13
 FWHM / FWTM 28.0° / 68.0°
 Efficiency 84 %
 Peak intensity 2.1 cd/m
 LEDs/each optic 1
 Light colour White
 Required components:
 C13709_PF-SOCKET-VERO13-18
 C12479_MIRELLA-DL

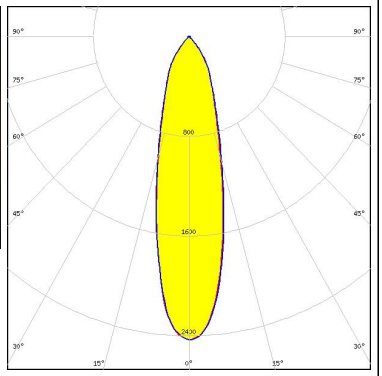

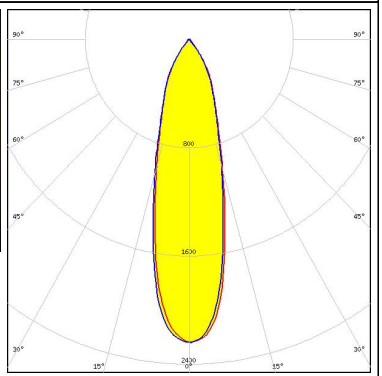
PHOTOMETRIC DATA (MEASURED):

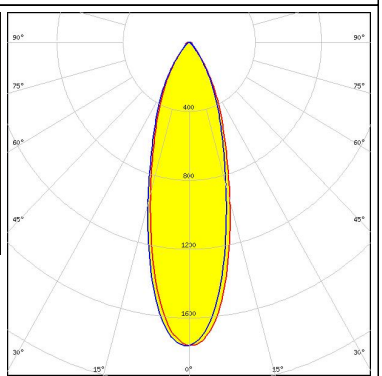
<p></p> <p>LED VERO13 FWHM / FWTM 26.0° / 67.0° Efficiency 83 % Peak intensity 2.3 cd/m LEDs/each optic 1 Light colour White</p> <p>Required components: C13709_PF-SOCKET-VERO13-18 C13333_MIRELLA-CL</p>		
<p></p> <p>LED Xenio Point 13mm FWHM / FWTM 26.0° / 69.0° Efficiency 87 % Peak intensity 2.4 cd/m LEDs/each optic 1 Light colour White</p> <p>Required components: C13709_PF-SOCKET-VERO13-18</p>		
<p></p> <p>LED Xenio Point 13mm FWHM / FWTM 27.0° / 67.0° Efficiency 83 % Peak intensity 2.2 cd/m LEDs/each optic 1 Light colour White</p> <p>Required components: C13709_PF-SOCKET-VERO13-18 C13333_MIRELLA-CL</p>		
<p></p> <p>LED Xenio Point 13mm FWHM / FWTM 31.0° / 70.0° Efficiency 81 % Peak intensity 1.8 cd/m LEDs/each optic 1 Light colour White</p> <p>Required components: C13709_PF-SOCKET-VERO13-18 C12479_MIRELLA-DL</p>		

PHOTOMETRIC DATA (MEASURED):

CITIZEN

LED CLL01x
 FWHM / FWTM 14.0° / 27.0°
 Efficiency 88 %
 Peak intensity 7.7 cd/m
 LEDs/each optic 1
 Light colour White
 Required components:
 C13083_PF-SOCKET

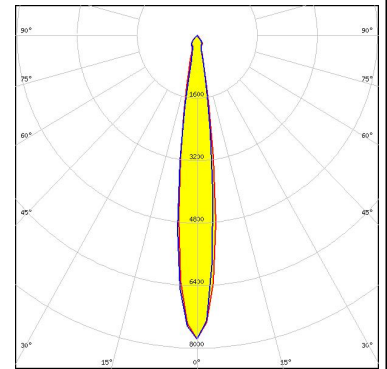

CITIZEN

LED CLL01x
 FWHM / FWTM 15.0° / 32.0°
 Efficiency 84 %
 Peak intensity 5.8 cd/m
 LEDs/each optic 1
 Light colour White
 Required components:
 C13083_PF-SOCKET
 C12479_MIRELLA-DL



CITIZEN

LED CLL01x
 FWHM / FWTM 13.0° / 27.0°
 Efficiency 84 %
 Peak intensity 7.6 cd/m
 LEDs/each optic 1
 Light colour White
 Required components:
 C13083_PF-SOCKET
 C13333_MIRELLA-CL



CITIZEN

LED CLL02x/CLU02x (LES10)
 FWHM / FWTM 21.0° / 63.0°
 Efficiency 84 %
 Peak intensity 3.1 cd/m
 LEDs/each optic 1
 Light colour White
 Required components:
 C13709_PF-SOCKET-VERO13-18
 Bender Wirth: 434 Typ L1

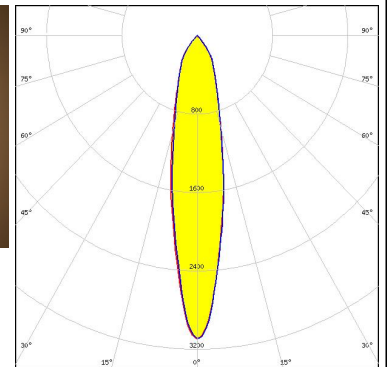
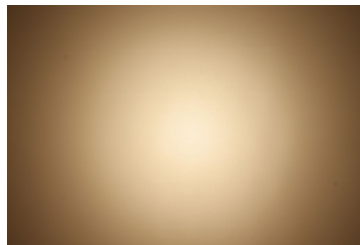

PHOTOMETRIC DATA (MEASURED):

CITIZEN

LED CLL02x/CLU02x (LES10)
 FWHM / FWTM 20.0° / 61.0°
 Efficiency 80 %
 Peak intensity 3.1 cd/m
 LEDs/each optic 1
 Light colour White
 Required components:
 C13709_PF-SOCKET-VERO13-18
 C13333_MIRELLA-CL
 Bender Wirth: 434 Typ L1

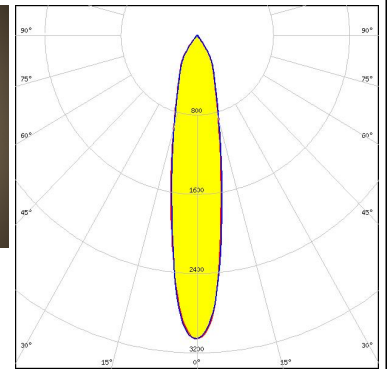

CITIZEN

LED CLL02x/CLU02x (LES10)
 FWHM / FWTM 25.0° / 64.0°
 Efficiency %
 Peak intensity 1.5 cd/m
 LEDs/each optic 1
 Light colour White
 Required components:
 C13083_PF-SOCKET
 C13723_MIRELLA-RZL

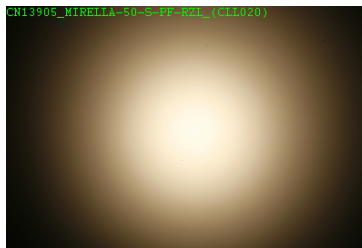

CITIZEN

LED CLL02x/CLU02x (LES10)
 FWHM / FWTM 19.0° / 46.0°
 Efficiency 87 %
 Peak intensity 4.2 cd/m
 LEDs/each optic 1
 Light colour White
 Required components:
 C13083_PF-SOCKET

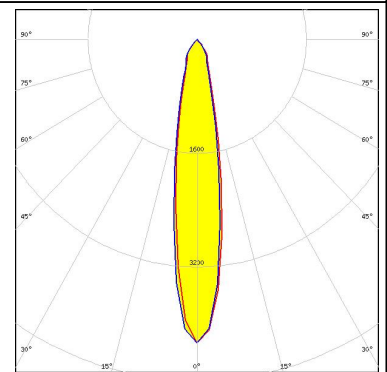

CITIZEN

LED CLL02x/CLU02x (LES10)
 FWHM / FWTM 20.0° / 54.0°
 Efficiency 83 %
 Peak intensity 4.2 cd/m
 LEDs/each optic 1
 Light colour White
 Required components:
 C13083_PF-SOCKET
 C12479_MIRELLA-DL



PHOTOMETRIC DATA (MEASURED):

CITIZEN

LED CLL02x/CLU02x (LES10)
 FWHM / FWTM 18.0° / 43.0°
 Efficiency 83 %
 Peak intensity 5.1 cd/lm
 LEDs/each optic 1
 Light colour White
 Required components:
 C13083_PF-SOCKET
 C13333_MIRELLA-CL



CITIZEN

LED CLL02x/CLU02x (LES10)
 FWHM / FWTM 27.0° / 67.0°
 Efficiency 77 %
 Peak intensity 2 cd/lm
 LEDs/each optic 1
 Light colour White
 Required components:
 C13709_PF-SOCKET-VERO13-18
 C12479_MIRELLA-DL
 Bender Wirth: 434 Typ L1

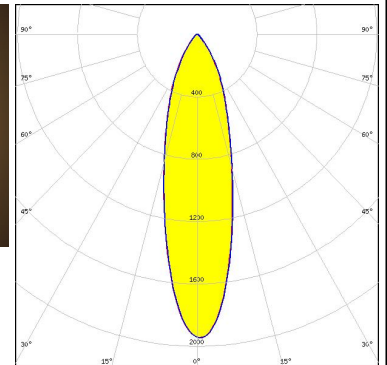
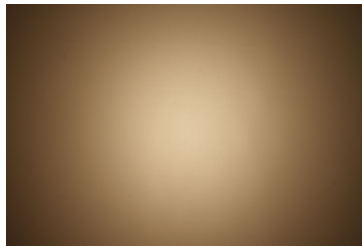

CITIZEN

LED CLU700/701/702
 FWHM / FWTM 20.0° / 58.0°
 Efficiency 79 %
 Peak intensity 3.1 cd/lm
 LEDs/each optic 1
 Light colour White
 Required components:
 C13709_PF-SOCKET-VERO13-18
 C12479_MIRELLA-DL
 Bender Wirth: 434 Typ L1

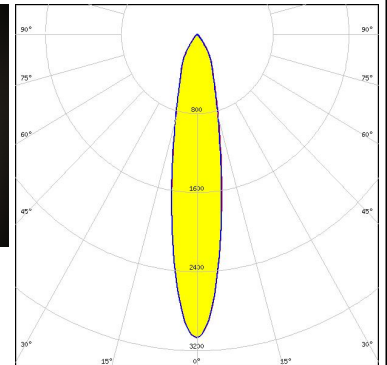
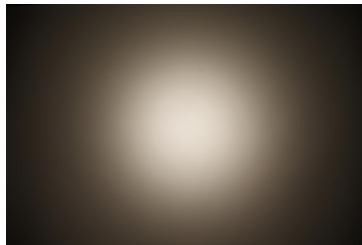

CITIZEN

LED CLU700/701/702
 FWHM / FWTM 17.0° / 47.0°
 Efficiency 82 %
 Peak intensity 4 cd/lm
 LEDs/each optic 1
 Light colour White
 Required components:
 C13083_PF-SOCKET
 C12479_MIRELLA-DL

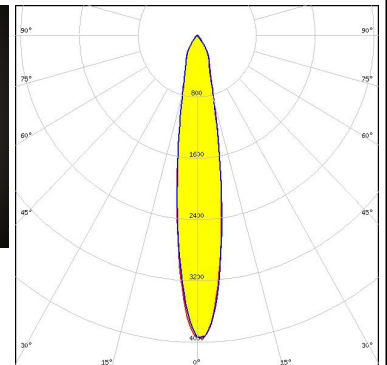
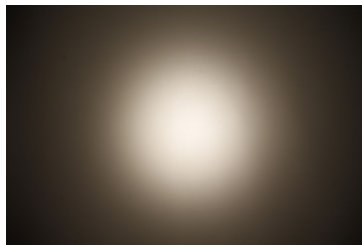

PHOTOMETRIC DATA (MEASURED):

CITIZEN

LED CLU700/701/702
 FWHM / FWTM 19.0° / 47.0°
 Efficiency 84 %
 Peak intensity 4 cd/m
 LEDs/each optic 1
 Light colour White
 Required components:
 C13709_PF-SOCKET-VERO13-18
 Bender Wirth: 434 Typ L1

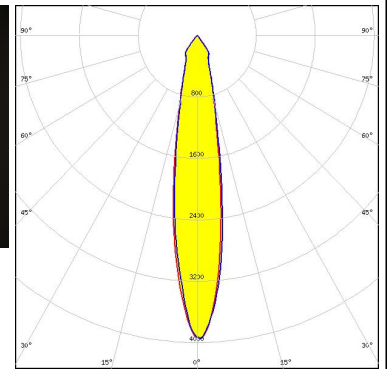

CITIZEN

LED CLU700/701/702
 FWHM / FWTM 13.0° / 30.0°
 Efficiency 83 %
 Peak intensity 6.6 cd/m
 LEDs/each optic 1
 Light colour White
 Required components:
 C13083_PF-SOCKET
 C13333_MIRELLA-CL

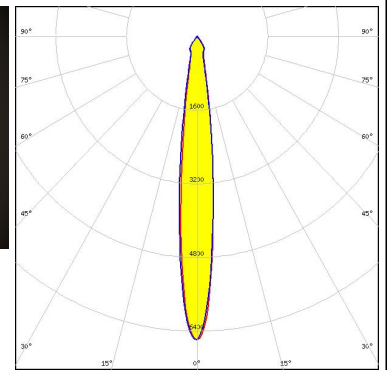

CITIZEN

LED CLU700/701/702
 FWHM / FWTM 14.0° / 40.0°
 Efficiency 79 %
 Peak intensity 4.8 cd/m
 LEDs/each optic 1
 Light colour White
 Required components:
 C13709_PF-SOCKET-VERO13-18
 C13333_MIRELLA-CL
 Bender Wirth: 434 Typ L1

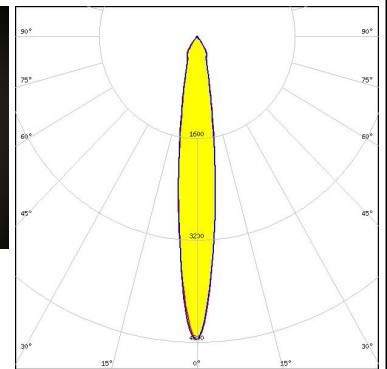

CITIZEN

LED CLU700/701/702
 FWHM / FWTM 13.0° / 29.0°
 Efficiency 89 %
 Peak intensity 7.3 cd/m
 LEDs/each optic 1
 Light colour White
 Required components:
 C13083_PF-SOCKET

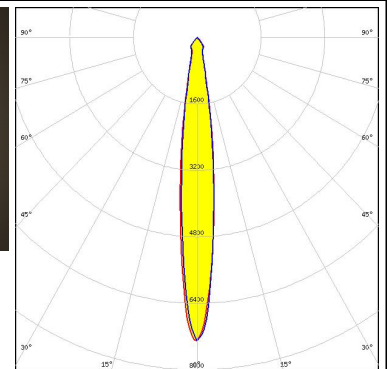
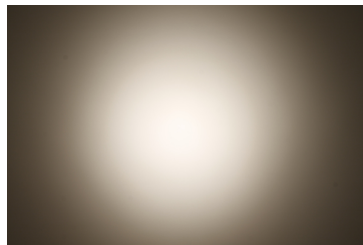

PHOTOMETRIC DATA (MEASURED):

CITIZEN

LED CLU700/701/702
 FWHM / FWTM 23.0° / 61.0°
 Efficiency 82 %
 Peak intensity 2.5 cd/m
 LEDs/each optic 1
 Light colour White
 Required components:
 C13083_PF-SOCKET
 C13723_MIRELLA-RZL

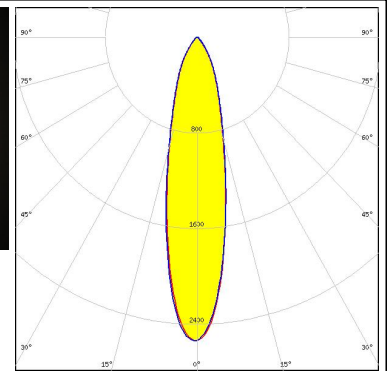
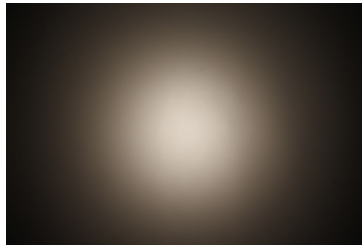

CITIZEN

LED CLU720/721
 FWHM / FWTM 29.0° / 69.0°
 Efficiency 75 %
 Peak intensity 1.7 cd/m
 LEDs/each optic 1
 Light colour White
 Required components:
 C13709_PF-SOCKET-VERO13-18
 C12479_MIRELLA-DL
 Bender Wirth: 433 Typ L1

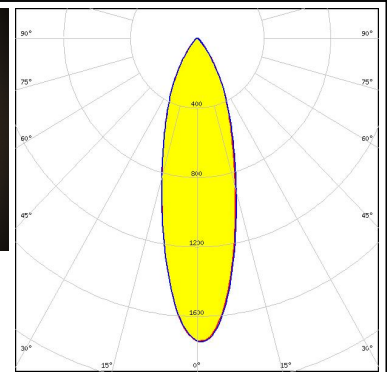
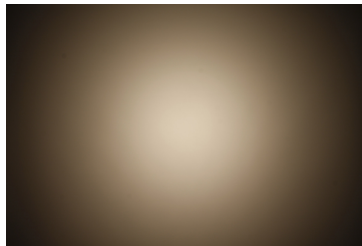

CITIZEN

LED CLU720/721
 FWHM / FWTM 23.0° / 67.0°
 Efficiency 82 %
 Peak intensity 2.6 cd/m
 LEDs/each optic 1
 Light colour White
 Required components:
 C13709_PF-SOCKET-VERO13-18
 Bender Wirth: 433 Typ L1

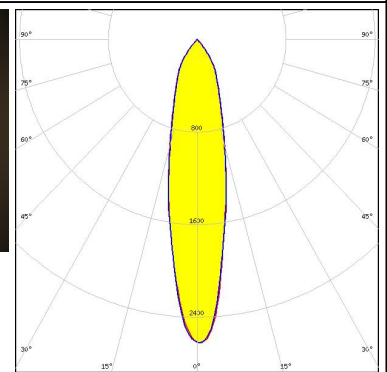
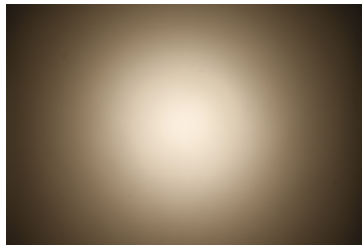

CITIZEN

LED CLU720/721
 FWHM / FWTM 23.0° / 64.0°
 Efficiency 77 %
 Peak intensity 2.5 cd/m
 LEDs/each optic 1
 Light colour White
 Required components:
 C13709_PF-SOCKET-VERO13-18
 C13333_MIRELLA-CL
 Bender Wirth: 433 Typ L1

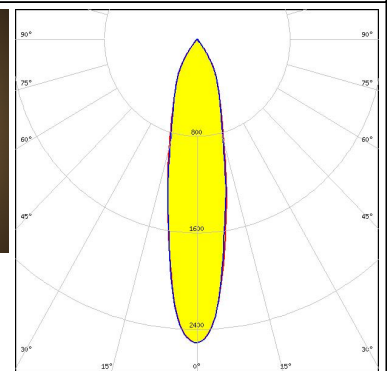
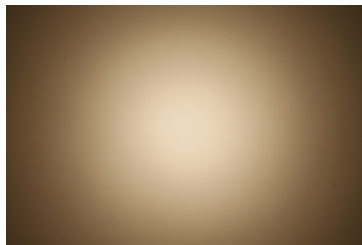

PHOTOMETRIC DATA (MEASURED):

CREE LED

LED CXA/B 13xx
 FWHM / FWTM 12.0° / 25.0°
 Efficiency 87 %
 Peak intensity 9.5 cd/lm
 LEDs/each optic 1
 Light colour White
 Required components:
 C13761_PF-SOCKET-CXA15

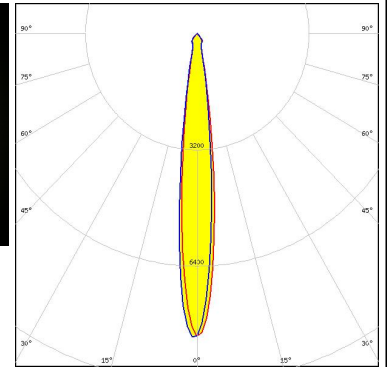

CREE LED

LED CXA/B 13xx
 FWHM / FWTM 12.0° / 25.0°
 Efficiency 82 %
 Peak intensity 8.5 cd/lm
 LEDs/each optic 1
 Light colour White
 Required components:
 C13761_PF-SOCKET-CXA15
 C13333_MIRELLA-CL



CREE LED

LED CXA/B 13xx
 FWHM / FWTM 15.0° / 36.0°
 Efficiency 81 %
 Peak intensity 5.4 cd/lm
 LEDs/each optic 1
 Light colour White
 Required components:
 C13761_PF-SOCKET-CXA15
 C12479_MIRELLA-DL

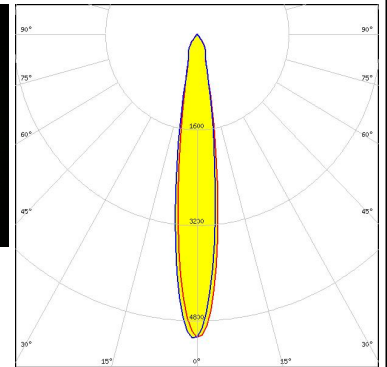





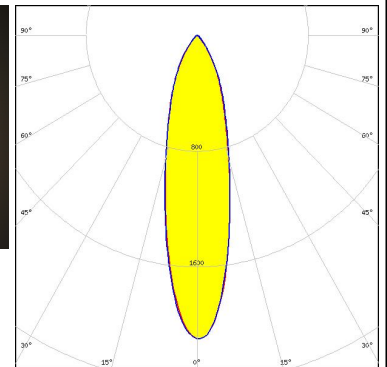
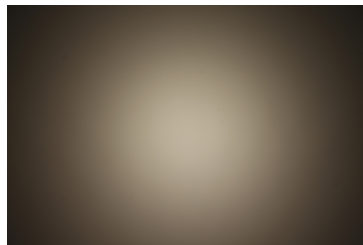

CREE LED

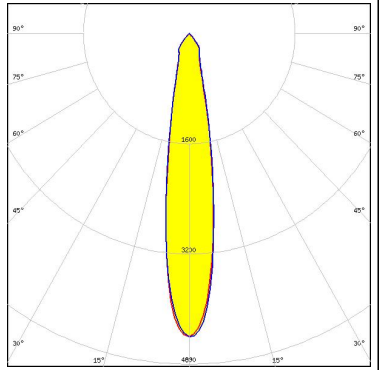
LED CXA/B 15xx
 FWHM / FWTM 26.0° / 66.0°
 Efficiency 77 %
 Peak intensity 2.1 cd/lm
 LEDs/each optic 1
 Light colour White
 Required components:
 C13709_PF-SOCKET-VERO13-18
 C12479_MIRELLA-DL
 Bender Wirth: 441 Typ L1

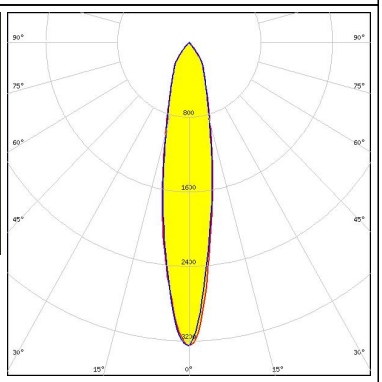

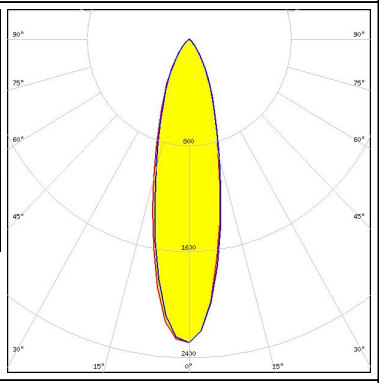
PHOTOMETRIC DATA (MEASURED):

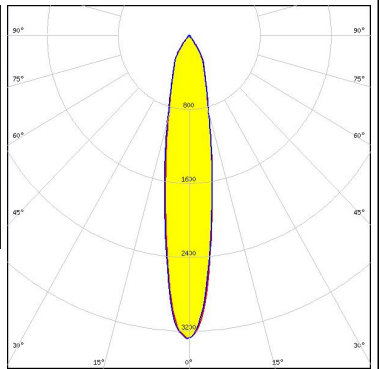
<p>CREE LED</p> <p>LED CXA/B 15xx FWHM / FWTM 18.0° / 43.0° Efficiency 91 % Peak intensity 4.4 cd/lm LEDs/each optic 1 Light colour White Required components: C13761_PF-SOCKET-CXA15</p>		
<p>CREE LED</p> <p>LED CXA/B 15xx FWHM / FWTM 20.0° / 60.0° Efficiency 84 % Peak intensity 3.3 cd/lm LEDs/each optic 1 Light colour White Required components: C13709_PF-SOCKET-VERO13-18 Bender Wirth: 441 Typ L1</p>		
<p>CREE LED</p> <p>LED CXA/B 15xx FWHM / FWTM 27.0° / 65.0° Efficiency 82 % Peak intensity 2.3 cd/lm LEDs/each optic 1 Light colour White Required components: C13761_PF-SOCKET-CXA15 C13723_MIRELLA-RZL</p>		
<p>CREE LED</p> <p>LED CXA/B 15xx FWHM / FWTM 19.0° / 59.0° Efficiency 79 % Peak intensity 3.3 cd/lm LEDs/each optic 1 Light colour White Required components: C13709_PF-SOCKET-VERO13-18 C13333_MIRELLA-CL Bender Wirth: 441 Typ L1</p>		

PHOTOMETRIC DATA (MEASURED):

CREE LED

LED CXA/B 15xx
 FWHM / FWTM 19.0° / 47.0°
 Efficiency 84 %
 Peak intensity 4.3 cd/lm
 LEDs/each optic 1
 Light colour White

Required components:

C13761_PF-SOCKET-CXA15
 C13333_MIRELLA-CL



CREE LED

LED CXA/B 15xx
 FWHM / FWTM 21.0° / 56.0°
 Efficiency 87 %
 Peak intensity 3.4 cd/lm
 LEDs/each optic 1
 Light colour White

Required components:

C13761_PF-SOCKET-CXA15
 C12479_MIRELLA-DL

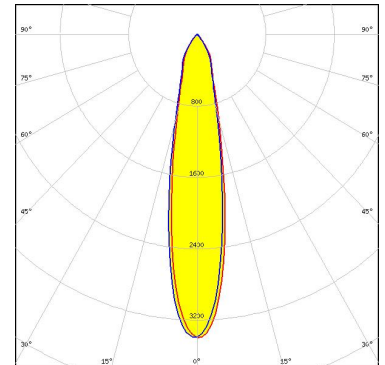

CREE LED

LED CXA/B 1816 & CXA/B 1820 & CXA 1850
 FWHM / FWTM 25.0° / 68.0°
 Efficiency 85 %
 Peak intensity 2.7 cd/lm
 LEDs/each optic 1
 Light colour White

Required components:

C14115_PF-SOCKET-CXA15-18

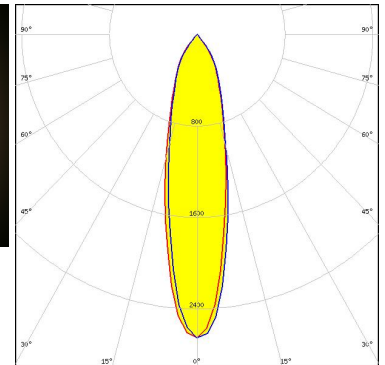
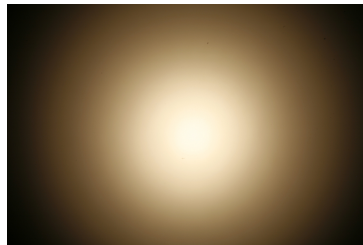

CREE LED





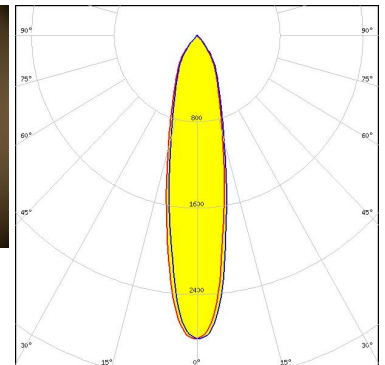
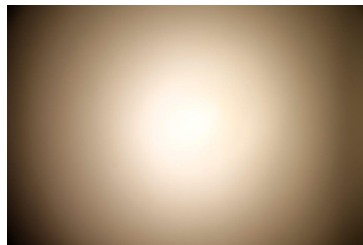

LED CXA/B 1816 & CXA/B 1820 & CXA 1850
 FWHM / FWTM 23.0° / 67.0°
 Efficiency 89 %
 Peak intensity 2.8 cd/lm
 LEDs/each optic 1
 Light colour White

Required components:

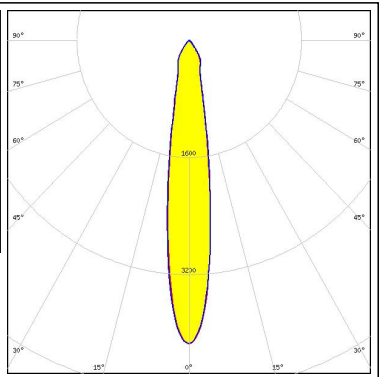
IDEAL: 50-2101CR + 50-2100MR

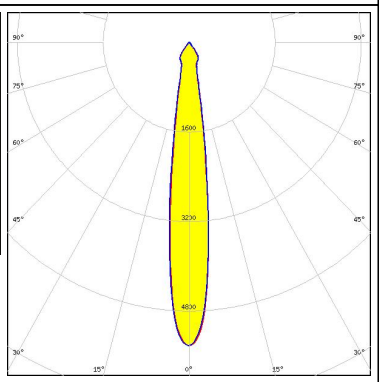

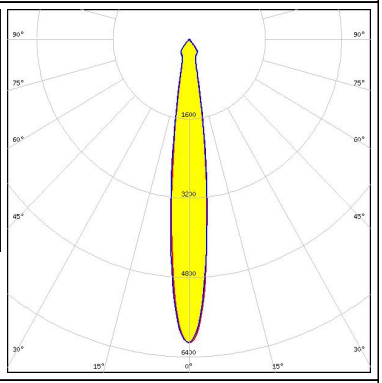
PHOTOMETRIC DATA (MEASURED):

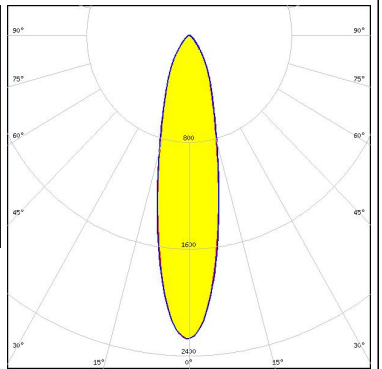
<p>CREE LED</p> <p>LED MHD-E/G FWHM / FWTM 17.0° / 44.0° Efficiency 87 % Peak intensity 4.1 cd/m LEDs/each optic 1 Light colour White</p> <p>Required components: C13083_PF-SOCKET C12479_MIRELLA-DL</p>		
<p>CREE LED</p> <p>LED MHD-E/G FWHM / FWTM 15.0° / 32.0° Efficiency 87 % Peak intensity 5.4 cd/m LEDs/each optic 1 Light colour White</p> <p>Required components: C13083_PF-SOCKET C13333_MIRELLA-CL</p>		
<p>CREE LED</p> <p>LED MHD-E/G FWHM / FWTM 14.0° / 31.0° Efficiency 93 % Peak intensity 6.1 cd/m LEDs/each optic 1 Light colour White</p> <p>Required components: C13083_PF-SOCKET</p>		
<p>CREE LED</p> <p>LED MHD-E/G FWHM / FWTM 24.0° / 65.0° Efficiency 84 % Peak intensity 2.3 cd/m LEDs/each optic 1 Light colour White</p> <p>Required components: C13083_PF-SOCKET C13723_MIRELLA-RZL</p>		

PHOTOMETRIC DATA (MEASURED):

CREE LED

LED MK-R
 FWHM / FWTM 12.0° / 27.0°
 Efficiency 87 %
 Peak intensity 8.1 cd/m
 LEDs/each optic 1
 Light colour White
 Required components:
 C13083_PF-SOCKET

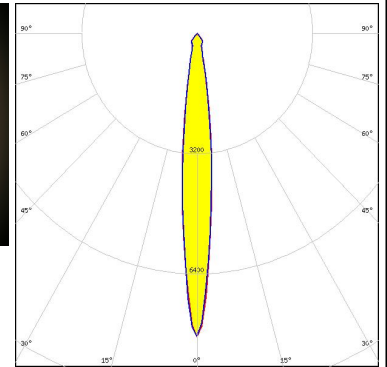

CREE LED

LED MK-R
 FWHM / FWTM 15.0° / 37.0°
 Efficiency 82 %
 Peak intensity 4.9 cd/m
 LEDs/each optic 1
 Light colour White
 Required components:
 C13083_PF-SOCKET
 C12479_MIRELLA-DL

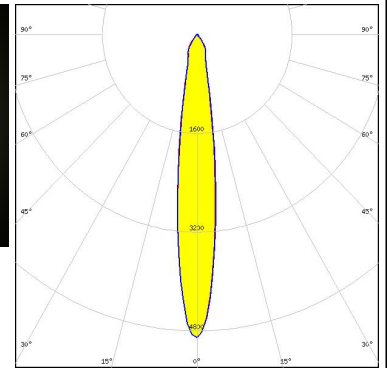

CREE LED

LED MT-G
 FWHM / FWTM 17.0° / 34.0°
 Efficiency 90 %
 Peak intensity 5.3 cd/m
 LEDs/each optic 1
 Light colour White
 Required components:
 C13083_PF-SOCKET

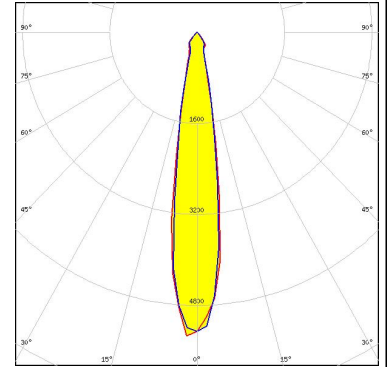

CREE LED

LED MT-G
 FWHM / FWTM 19.0° / 46.0°
 Efficiency 85 %
 Peak intensity 4.4 cd/m
 LEDs/each optic 1
 Light colour White
 Required components:
 C13083_PF-SOCKET
 C12479_MIRELLA-DL



PHOTOMETRIC DATA (MEASURED):

CREE LED

LED MT-G
 FWHM / FWTM 18.0° / 34.0°
 Efficiency 86 %
 Peak intensity 5.5 cd/lm
 LEDs/each optic 1
 Light colour White
 Required components:
 C13083_PF-SOCKET
 C13333_MIRELLA-CL



CREE LED

LED MT-G2
 FWHM / FWTM 18.0° / 35.0°
 Efficiency 88 %
 Peak intensity 4.2 cd/lm
 LEDs/each optic 1
 Light colour White
 Required components:
 C13083_PF-SOCKET

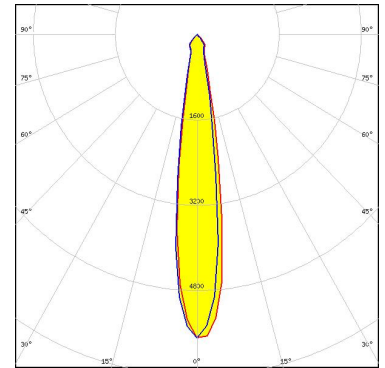

CREE LED

LED MT-G2
 FWHM / FWTM 18.0° / 43.0°
 Efficiency 85 %
 Peak intensity 4.6 cd/lm
 LEDs/each optic 1
 Light colour White
 Required components:
 C13083_PF-SOCKET
 C12479_MIRELLA-DL



CREE LED

LED MT-G2
 FWHM / FWTM 16.0° / 33.0°
 Efficiency 84 %
 Peak intensity 5.8 cd/lm
 LEDs/each optic 1
 Light colour White
 Required components:
 C13083_PF-SOCKET
 C13333_MIRELLA-CL



PHOTOMETRIC DATA (MEASURED):

CREE LED

LED XHP50
 FWHM / FWTM 22.0° / 60.0°
 Efficiency 81 %
 Peak intensity 2.6 cd/m
 LEDs/each optic 1
 Light colour White
 Required components:
 C13083_PF-SOCKET
 C13723_MIRELLA-RZL

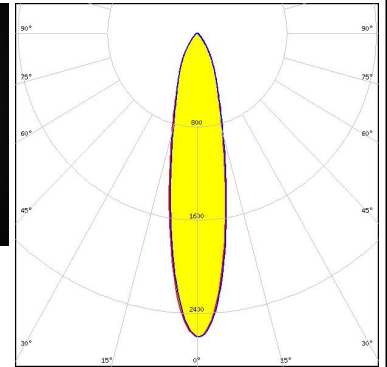
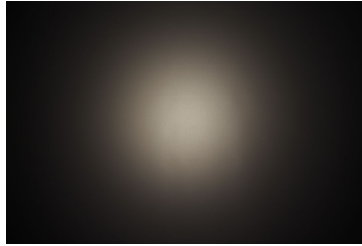

CREE LED

LED XHP50
 FWHM / FWTM 15.0° / 34.0°
 Efficiency 85 %
 Peak intensity 5.3 cd/m
 LEDs/each optic 1
 Light colour White
 Required components:
 C13083_PF-SOCKET
 C12479_MIRELLA-DL

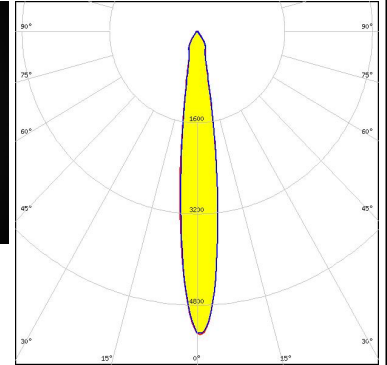

CREE LED

LED XHP50
 FWHM / FWTM 12.0° / 25.0°
 Efficiency 84 %
 Peak intensity 7.6 cd/m
 LEDs/each optic 1
 Light colour White
 Required components:
 C13083_PF-SOCKET
 C13333_MIRELLA-CL

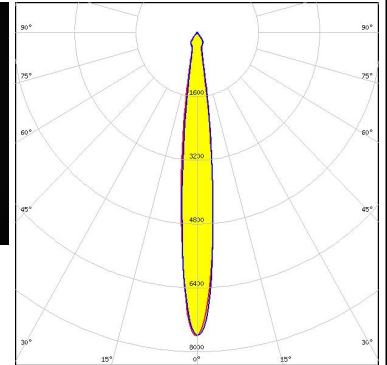





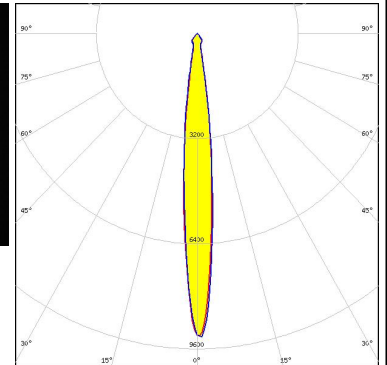

CREE LED

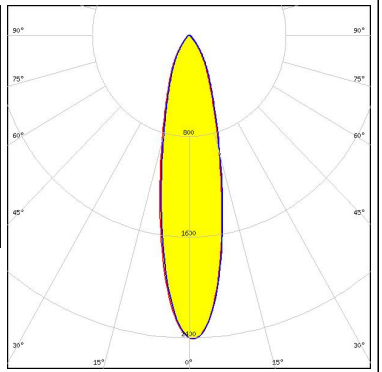
LED XHP50
 FWHM / FWTM 11.0° / 23.0°
 Efficiency 89 %
 Peak intensity 9.2 cd/m
 LEDs/each optic 1
 Light colour White
 Required components:
 C13083_PF-SOCKET

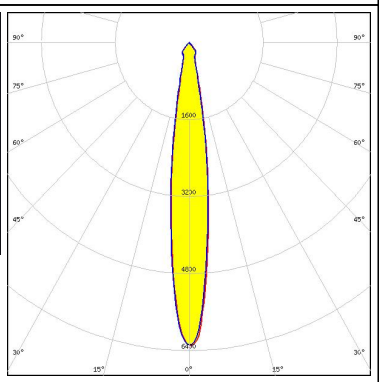

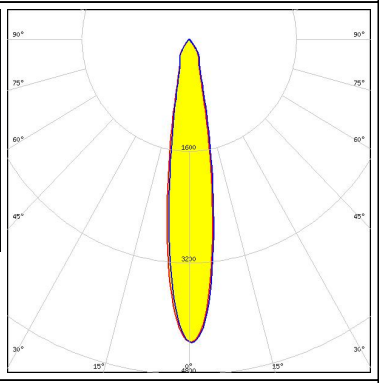
PHOTOMETRIC DATA (MEASURED):

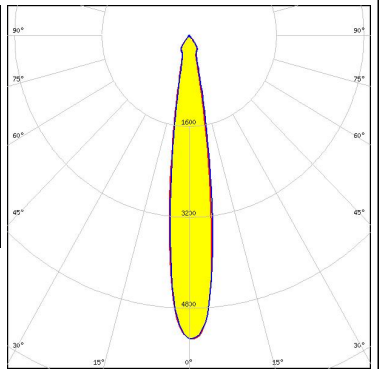
<p>CREE LED</p> <p>LED XHP70 FWHM / FWTM 24.0° / 62.0° Efficiency 81 % Peak intensity 2.4 cd/m LEDs/each optic 1 Light colour White</p> <p>Required components: C13083_PF-SOCKET C13723_MIRELLA-RZL</p>		
<p>CREE LED</p> <p>LED XHP70 FWHM / FWTM 15.0° / 31.0° Efficiency 89 % Peak intensity 0.6 cd/m LEDs/each optic 1 Light colour White</p> <p>Required components: C13083_PF-SOCKET</p>		
<p>CREE LED</p> <p>LED XHP70 FWHM / FWTM 17.0° / 40.0° Efficiency 84 % Peak intensity 4.3 cd/m LEDs/each optic 1 Light colour White</p> <p>Required components: C13083_PF-SOCKET C12479_MIRELLA-DL</p>		
<p>CREE LED</p> <p>LED XHP70 FWHM / FWTM 16.0° / 32.0° Efficiency 83 % Peak intensity 5.3 cd/m LEDs/each optic 1 Light colour White</p> <p>Required components: C13083_PF-SOCKET C13333_MIRELLA-CL</p>		

PHOTOMETRIC DATA (MEASURED):

CREE LED

LED XM-L RGB
 FWHM / FWTM 22.0° / 55.0°
 Efficiency 80 %
 Peak intensity 3.1 cd/m
 LEDs/each optic 1
 Light colour White
 Required components:
 C13083_PF-SOCKET
 C13723_MIRELLA-RZL

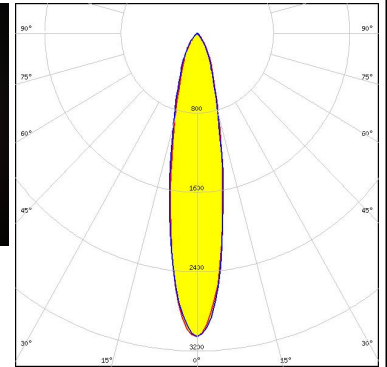
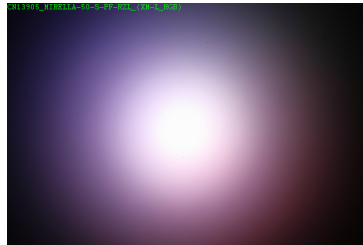

CREE LED

LED XQ-E HI
 FWHM / FWTM 21.0° / 58.0°
 Efficiency 86 %
 Peak intensity 3.1 cd/m
 LEDs/each optic 4
 Light colour RGBW
 Required components:
 C13083_PF-SOCKET
 C13723_MIRELLA-RZL

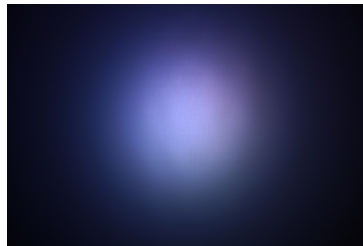

LUMILEDS

LED LUXEON CoB 1202/1203
 FWHM / FWTM 19.0° / 59.0°
 Efficiency 82 %
 Peak intensity 3.3 cd/m
 LEDs/each optic 1
 Light colour White
 Required components:
 C13333_MIRELLA-CL
 IDEAL: 50-2100NC +50-2100MR

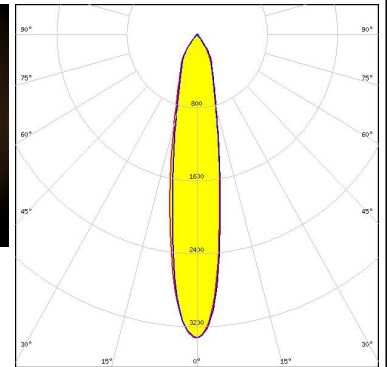
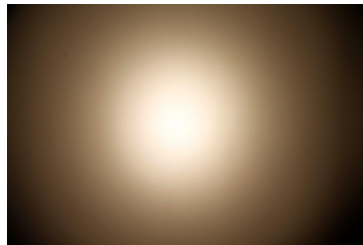

LUMILEDS



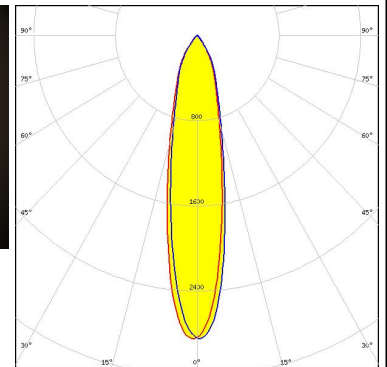
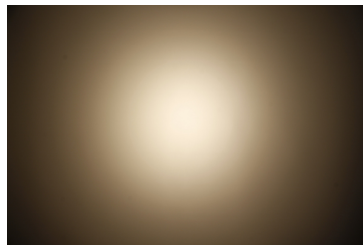

LED LUXEON CoB 1202/1203
 FWHM / FWTM 22.0° / 61.0°
 Efficiency 83 %
 Peak intensity 2.9 cd/m
 LEDs/each optic 1
 Light colour White
 Required components:
 C12479_MIRELLA-DL
 IDEAL: 50-2100NC +50-2100MR

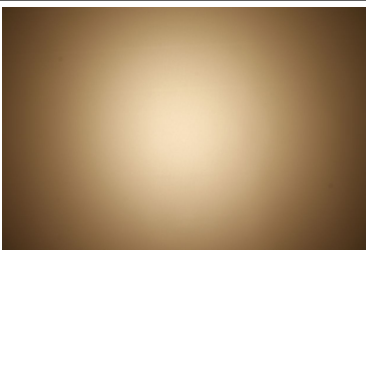
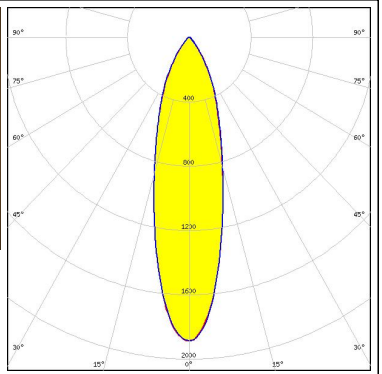
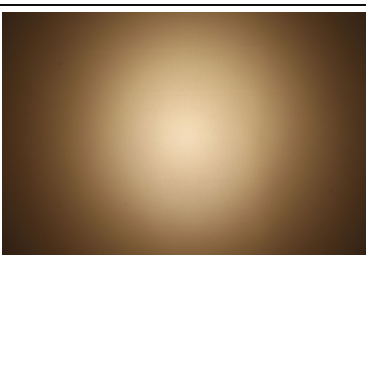
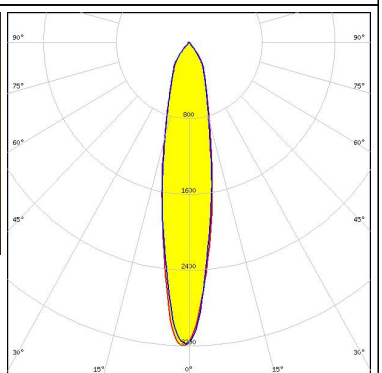
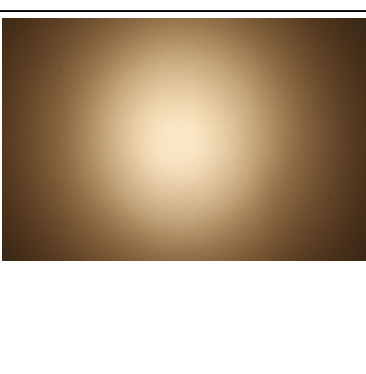
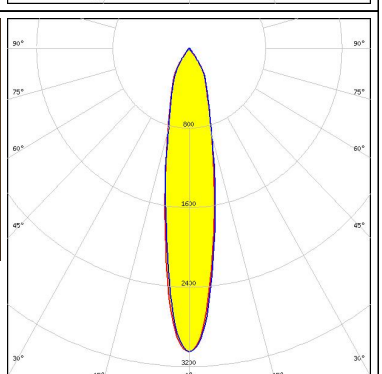
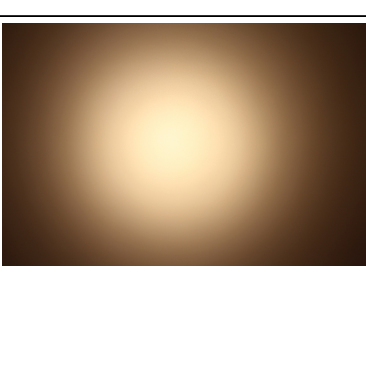
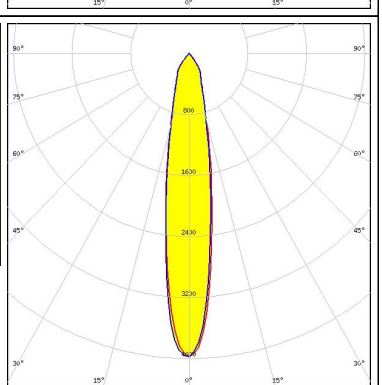



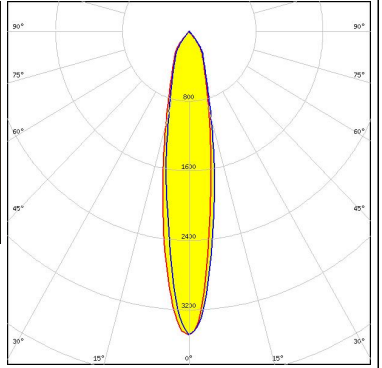

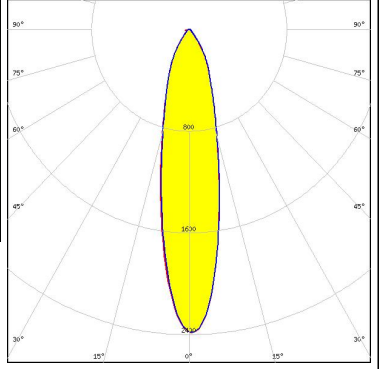

PHOTOMETRIC DATA (MEASURED):

<p>LUMILEDS</p> <p>LED LUXEON CoB 1202/1203</p> <p>FWHM / FWTM 27.0° / 67.0°</p> <p>Efficiency 76 %</p> <p>Peak intensity 1.9 cd/lm</p> <p>LEDs/each optic 1</p> <p>Light colour White</p> <p>Required components:</p> <p>C13709_PF-SOCKET-VERO13-18</p> <p>C12479_MIRELLA-DL</p> <p>Bender Wirth: 438 Typ L1</p>		
<p>LUMILEDS</p> <p>LED LUXEON CoB 1202/1203</p> <p>FWHM / FWTM 20.0° / 61.0°</p> <p>Efficiency 84 %</p> <p>Peak intensity 3.2 cd/lm</p> <p>LEDs/each optic 1</p> <p>Light colour White</p> <p>Required components:</p> <p>C13709_PF-SOCKET-VERO13-18</p> <p>Bender Wirth: 438 Typ L1</p>		
<p>LUMILEDS</p> <p>LED LUXEON CoB 1202/1203</p> <p>FWHM / FWTM 20.0° / 61.0°</p> <p>Efficiency 78 %</p> <p>Peak intensity 3.1 cd/lm</p> <p>LEDs/each optic 1</p> <p>Light colour White</p> <p>Required components:</p> <p>C13709_PF-SOCKET-VERO13-18</p> <p>C13333_MIRELLA-CL</p> <p>Bender Wirth: 438 Typ L1</p>		
<p>LUMILEDS</p> <p>LED LUXEON CoB 1202/1203</p> <p>FWHM / FWTM 19.0° / 50.0°</p> <p>Efficiency 87 %</p> <p>Peak intensity 4 cd/lm</p> <p>LEDs/each optic 1</p> <p>Light colour White</p> <p>Required components:</p> <p>C14037_PF-NSX-SOCKET</p>		

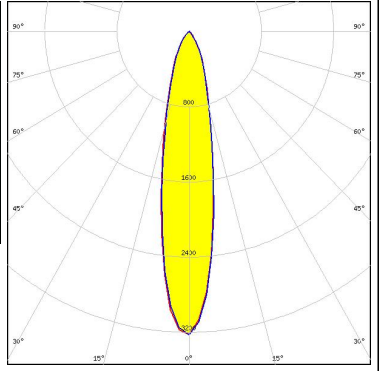

PHOTOMETRIC DATA (MEASURED):

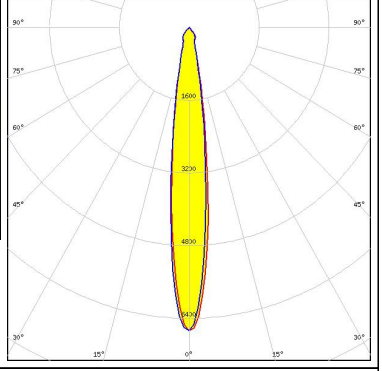
<p>LUMILEDS</p> <p>LED LUXEON CoB 1202/1203</p> <p>FWHM / FWTM 19.0° / 58.0°</p> <p>Efficiency 88 %</p> <p>Peak intensity 3.5 cd/lm</p> <p>LEDs/each optic 1</p> <p>Light colour White</p> <p>Required components: IDEAL: 50-2100NC +50-2100MR</p>		
<p>LUMILEDS</p> <p>LED LUXEON CoB 1202s</p> <p>FWHM / FWTM 23.0° / 63.0°</p> <p>Efficiency 79 %</p> <p>Peak intensity 2.4 cd/lm</p> <p>LEDs/each optic 1</p> <p>Light colour White</p> <p>Required components: C13709_PF-SOCKET-VERO13-18 C12479_MIRELLA-DL Bender Wirth: 452 Typ L1</p>		
<p>LUMILEDS</p> <p>LED LUXEON CoB 1202s</p> <p>FWHM / FWTM 13.0° / 28.0°</p> <p>Efficiency 84 %</p> <p>Peak intensity 7.6 cd/lm</p> <p>LEDs/each optic 1</p> <p>Light colour White</p> <p>Required components: C13761_PF-SOCKET-CXA15 C13333_MIRELLA-CL</p>		
<p>LUMILEDS</p> <p>LED LUXEON CoB 1202s</p> <p>FWHM / FWTM 15.0° / 36.0°</p> <p>Efficiency 84 %</p> <p>Peak intensity 5.9 cd/lm</p> <p>LEDs/each optic 1</p> <p>Light colour White</p> <p>Required components: C13761_PF-SOCKET-CXA15 C12479_MIRELLA-DL</p>		

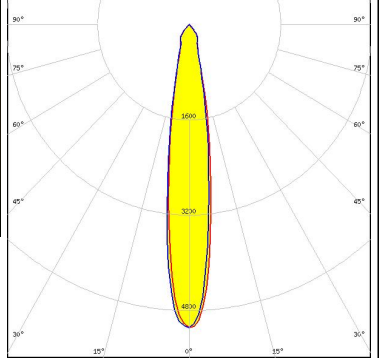

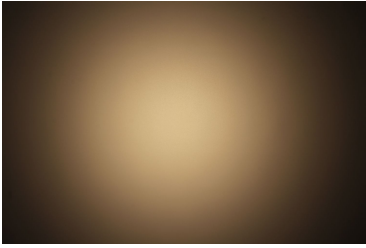
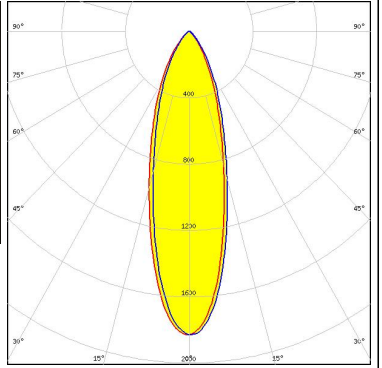
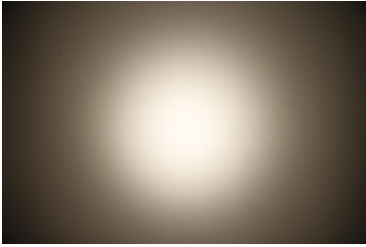
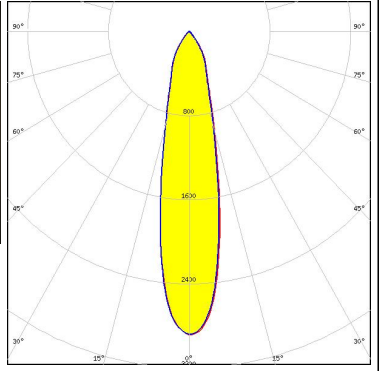

PHOTOMETRIC DATA (MEASURED):

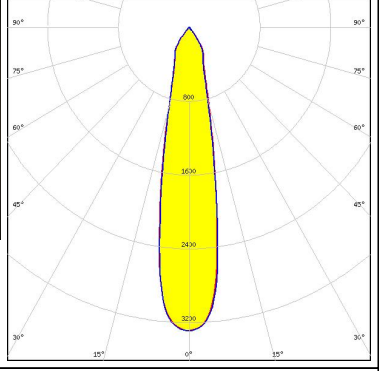
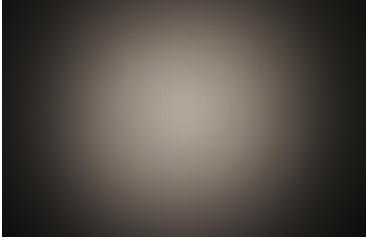
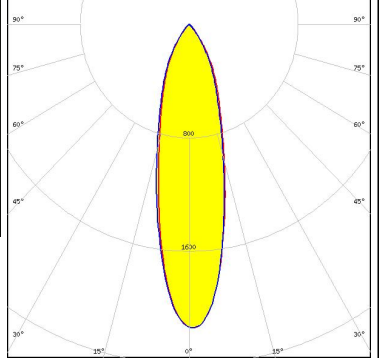
<p>LUMILEDS</p> <p>LED LUXEON CoB 1202s</p> <p>FWHM / FWTM 13.0° / 30.0°</p> <p>Efficiency 89 %</p> <p>Peak intensity 7.9 cd/lm</p> <p>LEDs/each optic 1</p> <p>Light colour White</p> <p>Required components: C13761_PF-SOCKET-CXA15</p>		
<p>LUMILEDS</p> <p>LED LUXEON Z</p> <p>FWHM / FWTM 21.0° / 54.0°</p> <p>Efficiency 78 %</p> <p>Peak intensity 3.2 cd/lm</p> <p>LEDs/each optic 4</p> <p>Light colour RGBW</p> <p>Required components: C13083_PF-SOCKET C13723_MIRELLA-RZL</p>		
<p>LUMINUS</p> <p>LED CxM-6 (12x13)</p> <p>FWHM / FWTM 14.0° / 32.0°</p> <p>Efficiency 86 %</p> <p>Peak intensity 6.7 cd/lm</p> <p>LEDs/each optic 1</p> <p>Light colour White</p> <p>Required components: C13083_PF-SOCKET</p>		
<p>LUMINUS</p> <p>LED CXM-7 (13x13)</p> <p>FWHM / FWTM 17.0° / 38.0°</p> <p>Efficiency 87 %</p> <p>Peak intensity 5.1 cd/lm</p> <p>LEDs/each optic 1</p> <p>Light colour White</p> <p>Required components: C13083_PF-SOCKET</p>		

PHOTOMETRIC DATA (MEASURED):

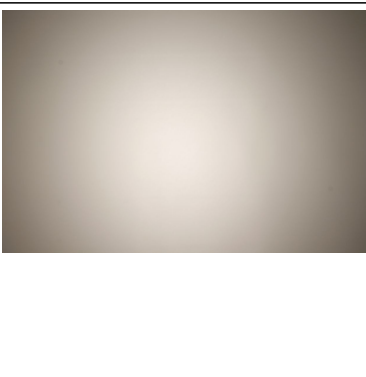
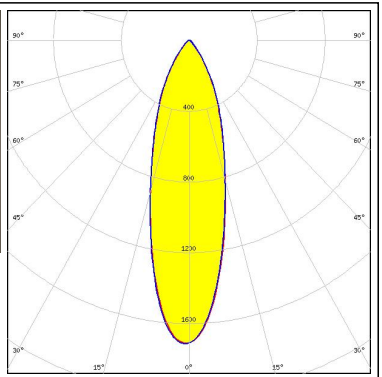
<p>LUMINUS</p> <p>LED CxM-9 (13.5x13.5) FWHM / FWTM 30.0° / 70.0° Efficiency 81 % Peak intensity 1.8 cd/lm LEDs/each optic 1 Light colour White Required components: C13083_PF-SOCKET C13723_MIRELLA-RZL</p>		
<p>LUMINUS</p> <p>LED CxM-9 (13.5x13.5) FWHM / FWTM 23.0° / 61.0° Efficiency 86 % Peak intensity 2.9 cd/lm LEDs/each optic 1 Light colour White Required components: C13083_PF-SOCKET C12479_MIRELLA-DL</p>		
<p>LUMINUS</p> <p>LED CxM-9 (13.5x13.5) FWHM / FWTM 21.0° / 58.0° Efficiency 85 % Peak intensity 3.3 cd/lm LEDs/each optic 1 Light colour White Required components: C13083_PF-SOCKET C13333_MIRELLA-CL</p>		
<p>NICHIA</p> <p>LED COB L-Type (LES 11) FWHM / FWTM 26.0° / 67.0° Efficiency 80 % Peak intensity 2.1 cd/lm LEDs/each optic 1 Light colour White Required components: C12479_MIRELLA-DL IDEAL: 50-2100NC +50-2100MR</p>		

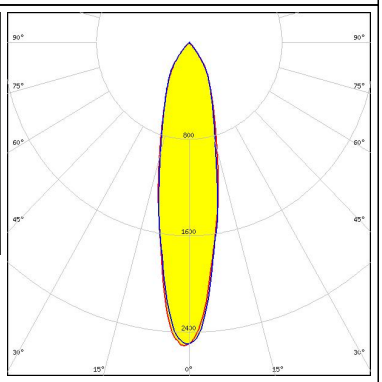
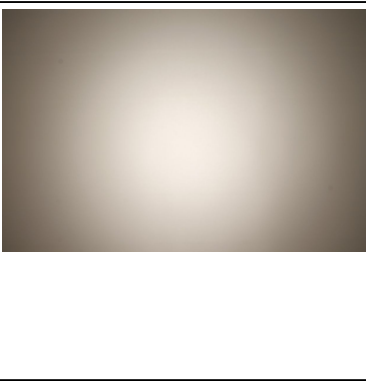
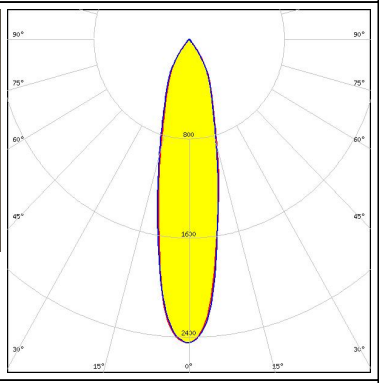

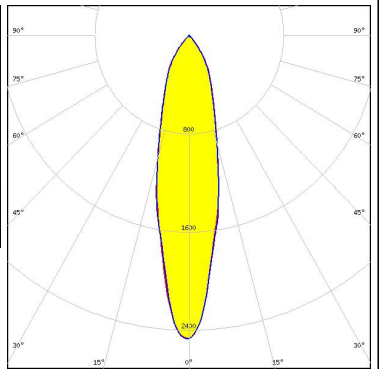

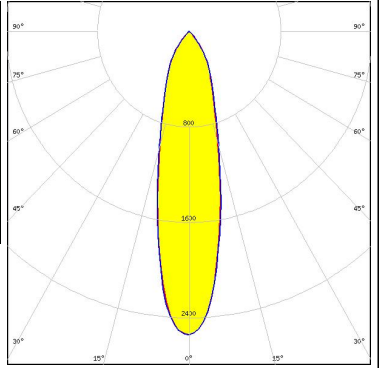
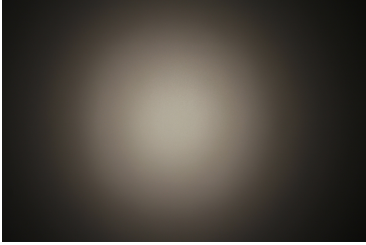
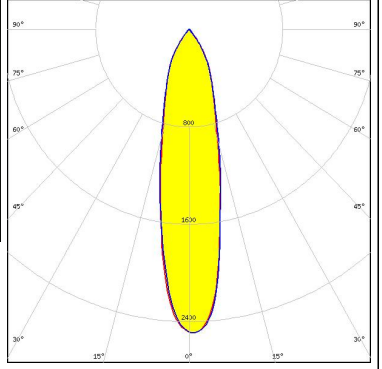
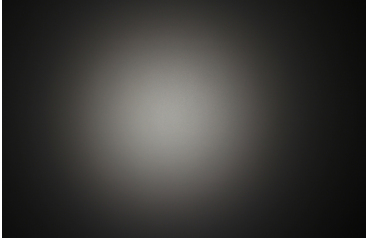
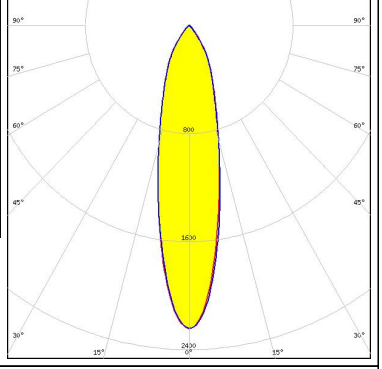
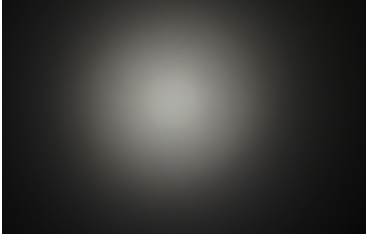
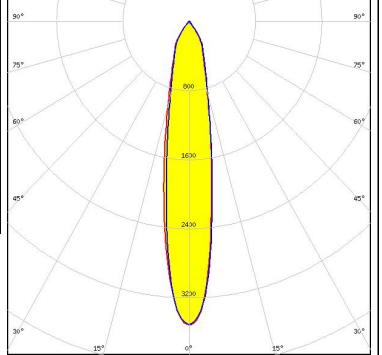

PHOTOMETRIC DATA (MEASURED):

<p>NICHIA</p> <p>LED COB L-Type (LES 11)</p> <p>FWHM / FWTM 30.0° / 70.0°</p> <p>Efficiency 76 %</p> <p>Peak intensity 1.7 cd/m</p> <p>LEDs/each optic 1</p> <p>Light colour White</p> <p>Required components:</p> <p>C13709_PF-SOCKET-VERO13-18</p> <p>C12479_MIRELLA-DL</p> <p>Bender Wirth: 438 Typ L1</p>		
<p>NICHIA</p> <p>LED COB L-Type (LES 11)</p> <p>FWHM / FWTM 24.0° / 68.0°</p> <p>Efficiency 81 %</p> <p>Peak intensity 2.5 cd/m</p> <p>LEDs/each optic 1</p> <p>Light colour White</p> <p>Required components:</p> <p>C13709_PF-SOCKET-VERO13-18</p> <p>Bender Wirth: 438 Typ L1</p>		
<p>NICHIA</p> <p>LED COB L-Type (LES 11)</p> <p>FWHM / FWTM 24.0° / 65.0°</p> <p>Efficiency 78 %</p> <p>Peak intensity 2.4 cd/m</p> <p>LEDs/each optic 1</p> <p>Light colour White</p> <p>Required components:</p> <p>C13709_PF-SOCKET-VERO13-18</p> <p>C13333_MIRELLA-CL</p> <p>Bender Wirth: 438 Typ L1</p>		
<p>NICHIA</p> <p>LED COB L-Type (LES 11)</p> <p>FWHM / FWTM 25.0° / 68.0°</p> <p>Efficiency 83 %</p> <p>Peak intensity 2.5 cd/m</p> <p>LEDs/each optic 1</p> <p>Light colour White</p> <p>Required components:</p> <p>IDEAL: 50-2100NC +50-2100MR</p>		

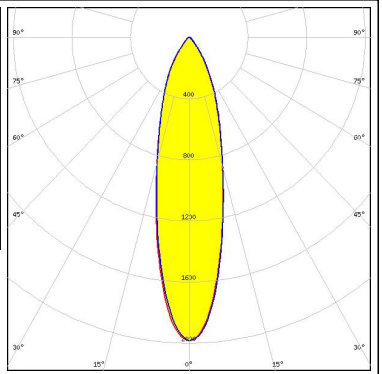

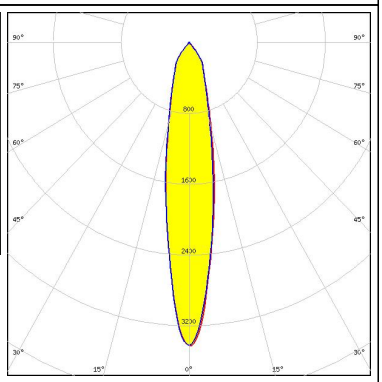

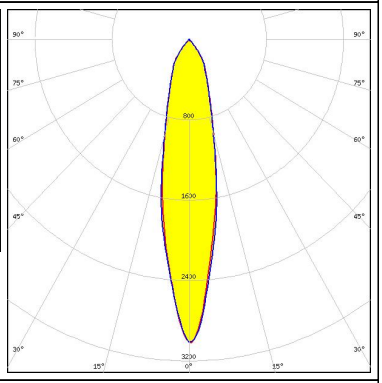

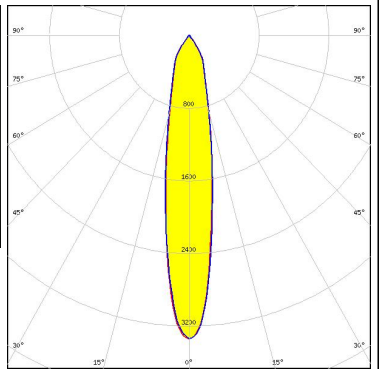
PHOTOMETRIC DATA (MEASURED):

<p>NICHIA</p> <p>LED COB L-Type (LES 11)</p> <p>FWHM / FWTM 25.0° / 68.0°</p> <p>Efficiency 86 %</p> <p>Peak intensity 2.5 cd/m</p> <p>LEDs/each optic 1</p> <p>Light colour White</p> <p>Required components: C14037_PF-NSX-SOCKET</p>		
<p>NICHIA</p> <p>LED COB L-Type (LES 11)</p> <p>FWHM / FWTM 24.0° / 65.0°</p> <p>Efficiency 81 %</p> <p>Peak intensity 2.5 cd/m</p> <p>LEDs/each optic 1</p> <p>Light colour White</p> <p>Required components: C13333_MIRELLA-CL IDEAL: 50-2100NC +50-2100MR</p>		
<p>NICHIA</p> <p>LED COB L-Type (LES 9)</p> <p>FWHM / FWTM 24.0° / 66.0°</p> <p>Efficiency 78 %</p> <p>Peak intensity 2.2 cd/m</p> <p>LEDs/each optic 1</p> <p>Light colour White</p> <p>Required components: C12479_MIRELLA-DL IDEAL: 50-2100NC +50-2100MR</p>		
<p>NICHIA</p> <p>LED COB L-Type (LES 9)</p> <p>FWHM / FWTM 18.0° / 56.0°</p> <p>Efficiency 83 %</p> <p>Peak intensity 3.5 cd/m</p> <p>LEDs/each optic 1</p> <p>Light colour White</p> <p>Required components: C13333_MIRELLA-CL IDEAL: 50-2100NC +50-2100MR</p>		

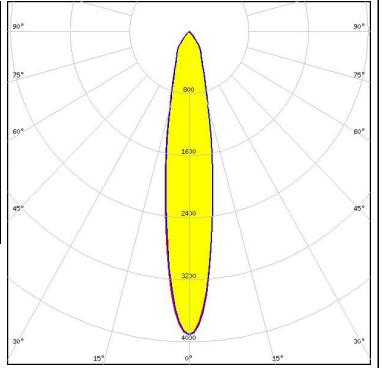

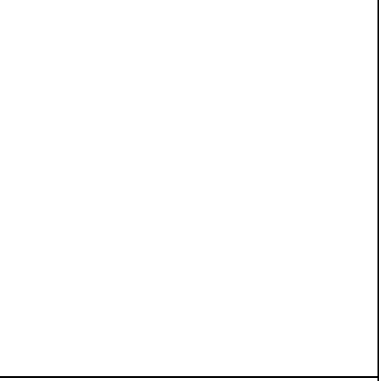
PHOTOMETRIC DATA (MEASURED):

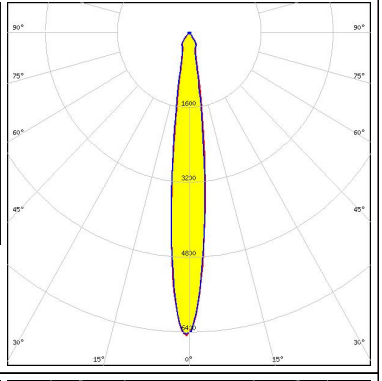
<p>NICHIA</p> <p>LED COB L-Type (LES 9)</p> <p>FWHM / FWTM 27.0° / 67.0°</p> <p>Efficiency 77 %</p> <p>Peak intensity 2 cd/lm</p> <p>LEDs/each optic 1</p> <p>Light colour White</p> <p>Required components:</p> <p>C13709_PF-SOCKET-VERO13-18</p> <p>C12479_MIRELLA-DL</p> <p>Bender Wirth: 438 Typ L1</p>		
<p>NICHIA</p> <p>LED COB L-Type (LES 9)</p> <p>FWHM / FWTM 19.0° / 57.0°</p> <p>Efficiency 85 %</p> <p>Peak intensity 3.4 cd/lm</p> <p>LEDs/each optic 1</p> <p>Light colour White</p> <p>Required components:</p> <p>C13709_PF-SOCKET-VERO13-18</p> <p>Bender Wirth: 438 Typ L1</p>		
<p>NICHIA</p> <p>LED COB L-Type (LES 9)</p> <p>FWHM / FWTM 22.0° / 64.0°</p> <p>Efficiency 84 %</p> <p>Peak intensity 3 cd/lm</p> <p>LEDs/each optic 1</p> <p>Light colour White</p> <p>Required components:</p> <p>IDEAL: 50-2100NC +50-2100MR</p>		
<p>NICHIA</p> <p>LED COB L-Type (LES 9)</p> <p>FWHM / FWTM 18.0° / 58.0°</p> <p>Efficiency 80 %</p> <p>Peak intensity 3.3 cd/lm</p> <p>LEDs/each optic 1</p> <p>Light colour White</p> <p>Required components:</p> <p>C13709_PF-SOCKET-VERO13-18</p> <p>C13333_MIRELLA-CL</p> <p>Bender Wirth: 438 Typ L1</p>		

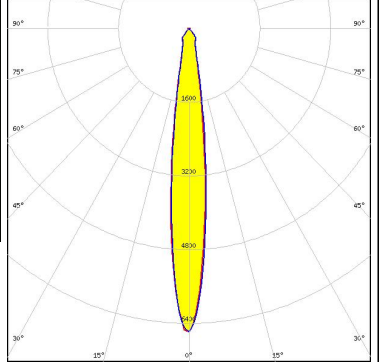



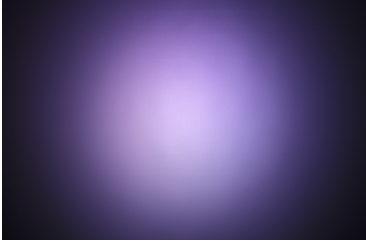
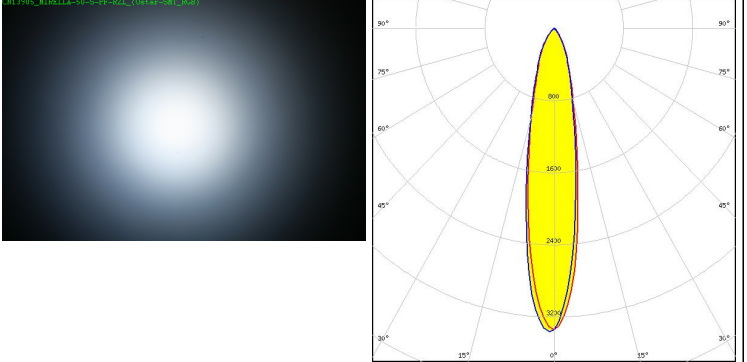

PHOTOMETRIC DATA (MEASURED):

<p>NICHIA</p> <p>LED COB L-Type (LES 9)</p> <p>FWHM / FWTM 19.0° / 52.0°</p> <p>Efficiency 88 %</p> <p>Peak intensity 3.9 cd/lm</p> <p>LEDs/each optic 1</p> <p>Light colour White</p> <p>Required components: C14037_PF-NSX-SOCKET</p>		
<p>NICHIA</p> <p>LED NSCxL036A</p> <p>FWHM / FWTM 16.0° / 38.0°</p> <p>Efficiency 86 %</p> <p>Peak intensity 5.1 cd/lm</p> <p>LEDs/each optic 1</p> <p>Light colour White</p> <p>Required components: C14037_PF-NSX-SOCKET</p>		
<p>OSRAM Opto Semiconductors</p> <p>LED Duris S10</p> <p>FWHM / FWTM 13.0° / 30.0°</p> <p>Efficiency 81 %</p> <p>Peak intensity 6.5 cd/lm</p> <p>LEDs/each optic 1</p> <p>Light colour White</p> <p>Required components: C13083_PF-SOCKET C13333_MIRELLA-CL</p>		
<p>OSRAM Opto Semiconductors</p> <p>LED Duris S10</p> <p>FWHM / FWTM 13.0° / 31.0°</p> <p>Efficiency 87 %</p> <p>Peak intensity 6.6 cd/lm</p> <p>LEDs/each optic 1</p> <p>Light colour White</p> <p>Required components: C13083_PF-SOCKET</p>		

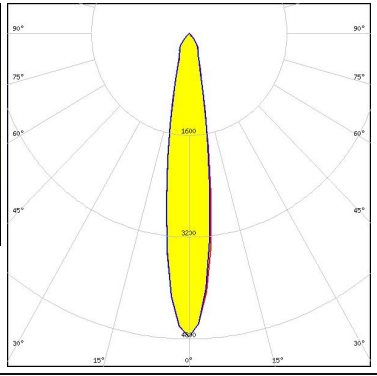
PHOTOMETRIC DATA (MEASURED):

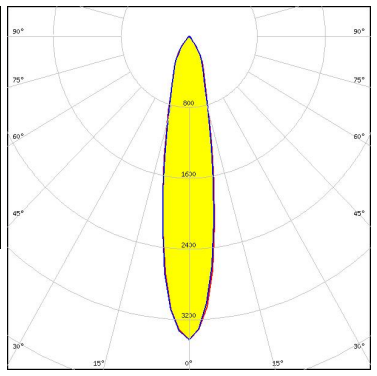
<p>OSRAM Opto Semiconductors</p> <p>LED Duris S10</p> <p>FWHM / FWTM 22.0° / 61.0°</p> <p>Efficiency 82 %</p> <p>Peak intensity 3 cd/lm</p> <p>LEDs/each optic 1</p> <p>Light colour White</p> <p>Required components: C13083_PF-SOCKET C13723_MIRELLA-RZL</p>	
<p>OSRAM Opto Semiconductors</p> <p>LED Duris S10</p> <p>FWHM / FWTM 18.0° / 54.0°</p> <p>Efficiency 80 %</p> <p>Peak intensity 3.6 cd/lm</p> <p>LEDs/each optic 1</p> <p>Light colour White</p> <p>Required components: C13083_PF-SOCKET C12479_MIRELLA-DL</p>	
<p>OSRAM Opto Semiconductors</p> <p>LED OSTAR Stage (S2WP)</p> <p>FWHM / FWTM 21.0° / 58.0°</p> <p>Efficiency 83 %</p> <p>Peak intensity 3.3 cd/lm</p> <p>LEDs/each optic 1</p> <p>Light colour White</p> <p>Required components: C13083_PF-SOCKET C13723_MIRELLA-RZL</p>	
<p>OSRAM Opto Semiconductors</p> <p>LED Ostar-SMT RGB</p> <p>FWHM / FWTM 20.0° / 55.0°</p> <p>Efficiency 82 %</p> <p>Peak intensity 3.4 cd/lm</p> <p>LEDs/each optic 1</p> <p>Light colour White</p> <p>Required components: C13083_PF-SOCKET C13723_MIRELLA-RZL</p>	

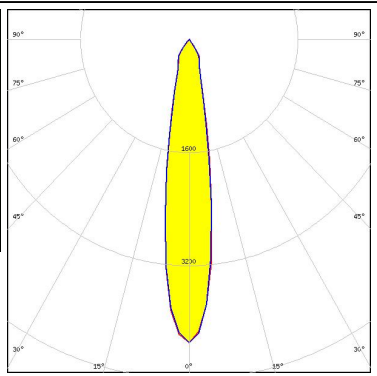
PHOTOMETRIC DATA (MEASURED):

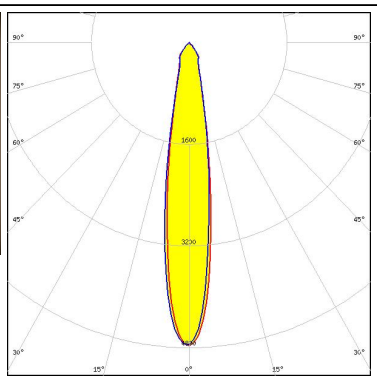
<p>SEOUL SEMICONDUCTOR</p> <p>LED ZC4/6 FWHM / FWTM 18.0° / 42.0° Efficiency 88 % Peak intensity 4.8 cd/m LEDs/each optic 1 Light colour White Required components: C13083_PF-SOCKET</p>		
<p>SEOUL SEMICONDUCTOR</p> <p>LED ZC4/6 FWHM / FWTM 21.0° / 56.0° Efficiency 83 % Peak intensity 3.4 cd/m LEDs/each optic 1 Light colour White Required components: C13083_PF-SOCKET C12479_MIRELLA-DL</p>		
<p>SEOUL SEMICONDUCTOR</p> <p>LED ZC4/6 FWHM / FWTM 19.0° / 44.0° Efficiency 83 % Peak intensity 4.3 cd/m LEDs/each optic 1 Light colour White Required components: C13083_PF-SOCKET C13333_MIRELLA-CL</p>		
<p>SHARP</p> <p>LED Mini Zenigata (GW6BM) FWHM / FWTM 17.0° / 41.0° Efficiency 91 % Peak intensity 4.8 cd/m LEDs/each optic 1 Light colour White Required components: C13083_PF-SOCKET</p>		

PHOTOMETRIC DATA (MEASURED):

SHARP

LED Mini Zenigata (GW6BM)
FWHM / FWTM 20.0° / 56.0°
Efficiency 84 %
Peak intensity 3.2 cd/lm
LEDs/each optic 1
Light colour White
Required components:
C13083_PF-SOCKET
C12479_MIRELLA-DL

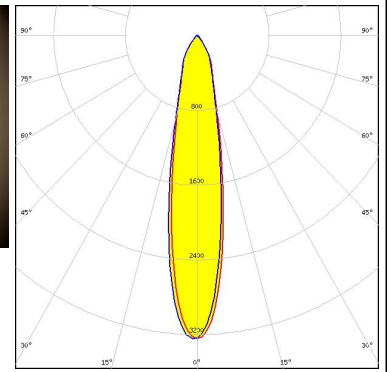
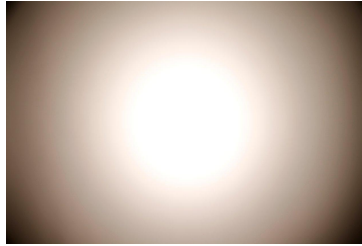



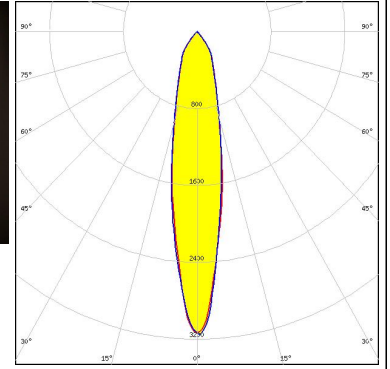
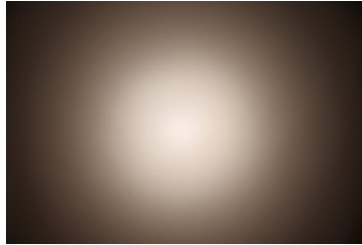

XICATO

LED XTM - 9mm LES
FWHM / FWTM 20.0° / 61.0°
Efficiency 82 %
Peak intensity 3.2 cd/lm
LEDs/each optic 1
Light colour White
Required components:
C14636_XTM-PF-ADAPTER

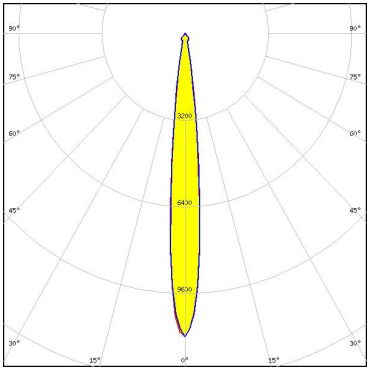

PHOTOMETRIC DATA (SIMULATED):

		
LED	XHP50.2	
FWHM / FWTM	11.0° / 22.0°	
Efficiency	90 %	
Peak intensity	11.2 cd/lm	
LEDs/each optic	1	
Light colour	White	
Required components:		
		
LED	LUXEON CoB Compact	
FWHM / FWTM	15.0° / 36.0°	
Efficiency	84 %	
Peak intensity	4.8 cd/lm	
LEDs/each optic	1	
Light colour	White	
Required components:		
C13761_PF-SOCKET-CXA15		
C12479_MIRELLA-DL		
		
LED	LUXEON CoB Compact	
FWHM / FWTM	23.0° / 63.0°	
Efficiency	79 %	
Peak intensity	2.4 cd/lm	
LEDs/each optic	1	
Light colour	White	
Required components:		
C13709_PF-SOCKET-VERO13-18		
C12479_MIRELLA-DL		
Bender Wirth: 452 Typ L1		
		
LED	LUXEON CoB Compact	
FWHM / FWTM	13.0° / 30.0°	
Efficiency	89 %	
Peak intensity	7.9 cd/lm	
LEDs/each optic	1	
Light colour	White	
Required components:		
C13761_PF-SOCKET-CXA15		

PHOTOMETRIC DATA (SIMULATED):

LUMILEDS

LED LUXEON CoB Compact
 FWHM / FWTM 13.0° / 28.0°
 Efficiency 84 %
 Peak intensity 7.6 cd/lm
 LEDs/each optic 1
 Light colour White
 Required components:
 C13761_PF-SOCKET-CXA15
 C13333_MIRELLA-CL

LUMILEDS

LED LUXEON K4
 FWHM / FWTM 42.0° / 87.0°
 Efficiency 84 %
 Peak intensity 1.2 cd/lm
 LEDs/each optic 1
 Light colour White
 Required components:
 C13761_PF-SOCKET-CXA15
 C12479_MIRELLA-DL

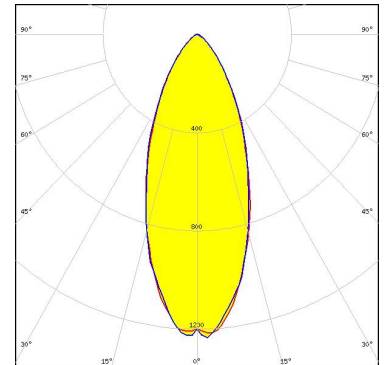

LUMILEDS

LED LUXEON K4
 FWHM / FWTM 24.0° / 72.0°
 Efficiency 88 %
 Peak intensity 2.9 cd/lm
 LEDs/each optic 1
 Light colour White
 Required components:
 C13761_PF-SOCKET-CXA15

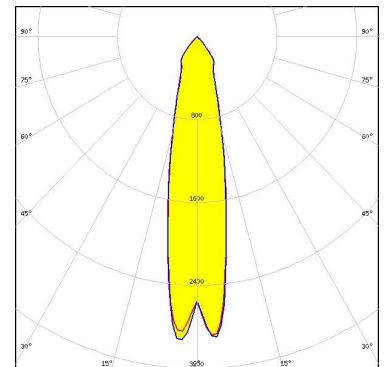

LUMINUS

LED CxM-14 (19x19)
 FWHM / FWTM 33.0° / 72.0°
 Efficiency 69 %
 Peak intensity 1.4 cd/lm
 LEDs/each optic 1
 Light colour White
 Required components:
 C13709_PF-SOCKET-VERO13-18
 C12479_MIRELLA-DL
 Bender Wirth: 433 Typ L1

PHOTOMETRIC DATA (SIMULATED):



LED CxM-14 (19x19)
FWHM / FWTM 31.0° / 70.0°
Efficiency 72 %
Peak intensity 1.7 cd/lm
LEDs/each optic 1
Light colour White
Required components:
C13709_PF-SOCKET-VERO13-18
C13333_MIRELLA-CL
Bender Wirth: 433 Typ L1



LED CxM-14 (19x19)
FWHM / FWTM 29.0° / 72.0°
Efficiency 76 %
Peak intensity 1.8 cd/lm
LEDs/each optic 1
Light colour White
Required components:
C13709_PF-SOCKET-VERO13-18



LED CxM-9 (13.5x13.5)
FWHM / FWTM 20.0° / 61.0°
Efficiency 80 %
Peak intensity 3.1 cd/lm
LEDs/each optic 1
Light colour White
Required components:
C13709_PF-SOCKET-VERO13-18
C13333_MIRELLA-CL
Bender Wirth: 434 Typ L1



LED CxM-9 (13.5x13.5)
FWHM / FWTM 21.0° / 63.0°
Efficiency 84 %
Peak intensity 3.1 cd/lm
LEDs/each optic 1
Light colour White
Required components:
C13709_PF-SOCKET-VERO13-18
Bender Wirth: 434 Typ L1

PHOTOMETRIC DATA (SIMULATED):

LUMINUS

LED CxM-9 (13.5x13.5)
FWHM / FWTM 27.0° / 67.0°
Efficiency 77 %
Peak intensity 2 cd/lm
LEDs/each optic 1
Light colour White
Required components:
C13709_PF-SOCKET-VERO13-18
C12479_MIRELLA-DL
Bender Wirth: 434 Typ L1

NICHIA

LED COB S-Type (LES 7)
FWHM / FWTM 23.0° / 63.0°
Efficiency 79 %
Peak intensity 2.4 cd/lm
LEDs/each optic 1
Light colour White
Required components:
C13709_PF-SOCKET-VERO13-18
C12479_MIRELLA-DL
Bender Wirth: 452 Typ L1

NICHIA

LED COB S-Type (LES 7)
FWHM / FWTM 15.0° / 41.0°
Efficiency 83 %
Peak intensity 4.9 cd/lm
LEDs/each optic 1
Light colour White
Required components:
C13709_PF-SOCKET-VERO13-18
C13333_MIRELLA-CL
Bender Wirth: 452 Typ L1

NICHIA

LED COB S-Type (LES 7)
FWHM / FWTM 19.0° / 49.0°
Efficiency 87 %
Peak intensity 3.9 cd/lm
LEDs/each optic 1
Light colour White
Required components:
C13709_PF-SOCKET-VERO13-18
Bender Wirth: 452 Typ L1

PHOTOMETRIC DATA (SIMULATED):

OSRAM

Opto Semiconductors

LED Duris S8
 FWHM / FWTM 14.0° / 29.0°
 Efficiency 90 %
 Peak intensity 7.4 cd/lm
 LEDs/each optic 1
 Light colour White
 Required components:
 C13083_PF-SOCKET
 C12479_MIRELLA-DL

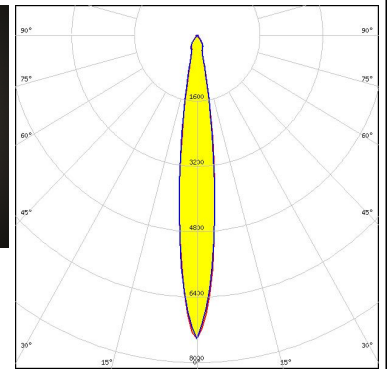
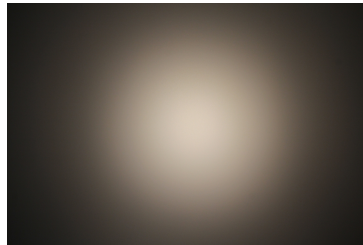

OSRAM

Opto Semiconductors

LED Duris S8
 FWHM / FWTM 9.5° / 24.0°
 Efficiency 94 %
 Peak intensity 12.5 cd/lm
 LEDs/each optic 1
 Light colour White
 Required components:
 C13083_PF-SOCKET

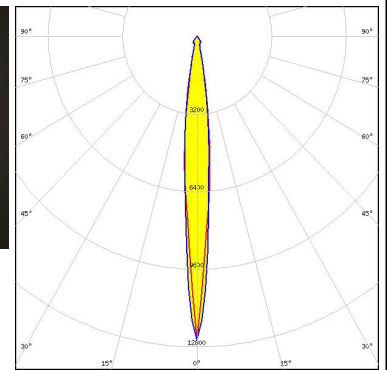

OSRAM

Opto Semiconductors

LED Soleriq S15
 FWHM / FWTM 28.0° / 74.0°
 Efficiency 85 %
 Peak intensity 2 cd/lm
 LEDs/each optic 1
 Light colour White
 Required components:
 C13709_PF-SOCKET-VERO13-18
 Bender Wirth: 433 Typ L1

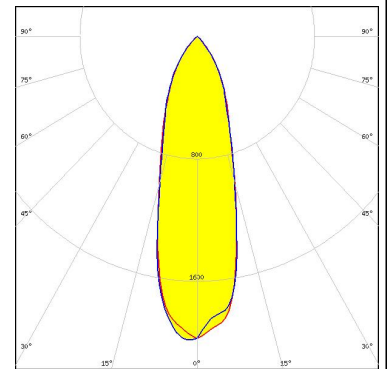

OSRAM

Opto Semiconductors

LED Soleriq S9
 FWHM / FWTM 24.0° / 61.0°
 Efficiency 87 %
 Peak intensity 2.9 cd/lm
 LEDs/each optic 1
 Light colour White
 Required components:
 C13083_PF-SOCKET
 C13333_MIRELLA-CL

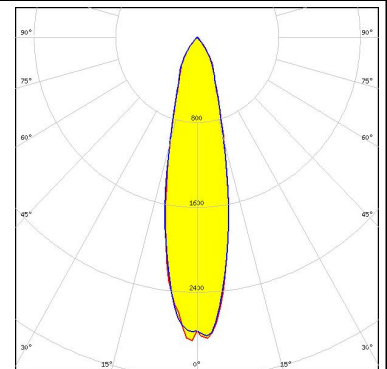

PHOTOMETRIC DATA (SIMULATED):

OSRAM

Opto Semiconductors

LED Soleriq S9
 FWHM / FWTM 24.0° / 61.0°
 Efficiency 86 %
 Peak intensity 2.9 cd/lm
 LEDs/each optic 1
 Light colour White
 Required components:
 C13083_PF-SOCKET
 C12479_MIRELLA-DL

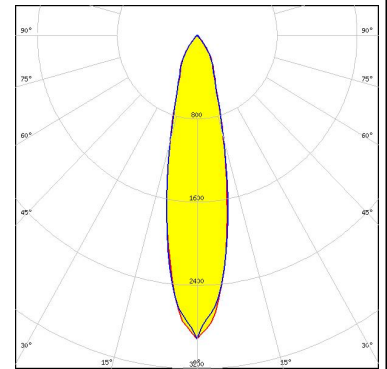

OSRAM

Opto Semiconductors

LED Soleriq S9
 FWHM / FWTM 19.0° / 56.0°
 Efficiency 87 %
 Peak intensity 3.7 cd/lm
 LEDs/each optic 1
 Light colour White
 Required components:
 C13709_PF-SOCKET-VERO13-18
 Bender Wirth: 434 Typ L1

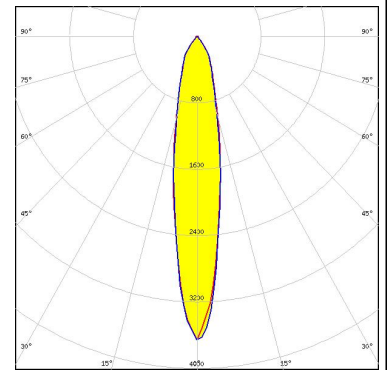

OSRAM

Opto Semiconductors

LED Soleriq S9
 FWHM / FWTM 21.0° / 54.0°
 Efficiency 91 %
 Peak intensity 3.5 cd/lm
 LEDs/each optic 1
 Light colour White
 Required components:
 C13083_PF-SOCKET

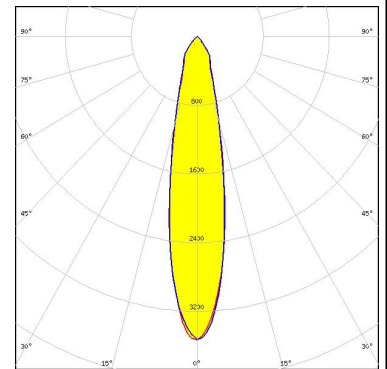

SAMSUNG

LED LC010C
 FWHM / FWTM 16.0° / 41.0°
 Efficiency 87 %
 Peak intensity 4.8 cd/lm
 LEDs/each optic 1
 Light colour White
 Required components:
 C13709_PF-SOCKET-VERO13-18
 Bender Wirth: 479 Typ L1

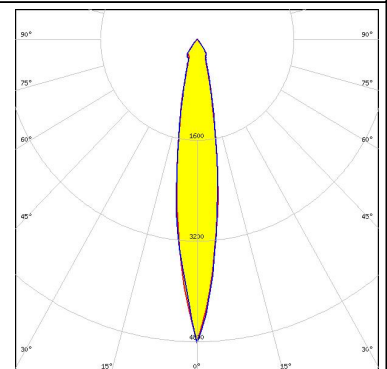

PHOTOMETRIC DATA (SIMULATED):

SAMSUNG

LED LC020C
 FWHM / FWTM 16.0° / 49.0°
 Efficiency 86 %
 Peak intensity 4.1 cd/lm
 LEDs/each optic 1
 Light colour White
 Required components:
 C13709_PF-SOCKET-VERO13-18
 Bender Wirth: 479 Typ L1

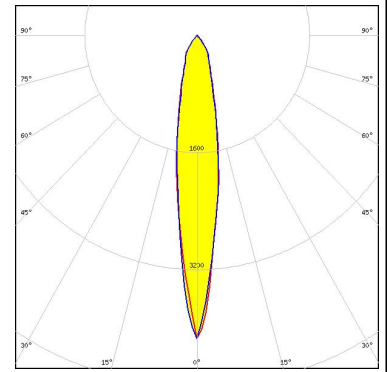

SAMSUNG

LED LC040C
 FWHM / FWTM 23.0° / 66.0°
 Efficiency 84 %
 Peak intensity 2.6 cd/lm
 LEDs/each optic 1
 Light colour White
 Required components:
 C13709_PF-SOCKET-VERO13-18
 Bender Wirth: 480 Typ L1

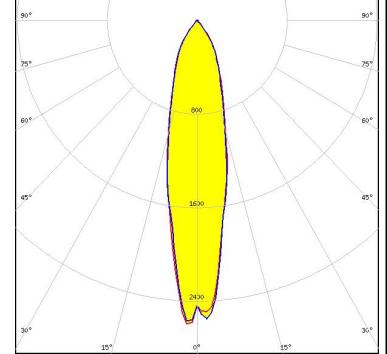

SEOUL SEMICONDUCTOR

LED ZC4/6
 FWHM / FWTM 20.0° / 61.0°
 Efficiency 80 %
 Peak intensity 3.1 cd/lm
 LEDs/each optic 1
 Light colour White
 Required components:
 C13709_PF-SOCKET-VERO13-18
 C13333_MIRELLA-CL
 Bender Wirth: 434 Typ L1



SEOUL SEMICONDUCTOR

LED ZC4/6
 FWHM / FWTM 21.0° / 63.0°
 Efficiency 84 %
 Peak intensity 3.1 cd/lm
 LEDs/each optic 1
 Light colour White
 Required components:
 C13709_PF-SOCKET-VERO13-18
 Bender Wirth: 434 Typ L1

PHOTOMETRIC DATA (SIMULATED):

	
SEOUL SEMICONDUCTOR	
LED	ZC4/6
FWHM / FWTM	27.0° / 67.0°
Efficiency	77 %
Peak intensity	2 cd/lm
LEDs/each optic	1
Light colour	White
Required components:	
C13709_PF-SOCKET-VERO13-18	
C12479_MIRELLA-DL	
Bender Wirth: 434 Typ L1	

GENERAL INFORMATION:

NOTE: The typical beam angle will be changed by different color, chip size and chip position tolerance. The typical total beam angle is the full angle measured where the luminous intensity is half of the peak value.

Due to use of high power COB's with this product, special attention to proper thermal design is highly recommended. LEDiL has no liability for direct, indirect or consecutive damages arising from the LEDiL products being used outside of the recommended temperature range.

MATERIALS:

As part of our continuous research and improvement processes, and to ensure the best possible quality and availability of our products, LEDiL reserves the right to change material grades without notice.

PRODUCT DATA USER AGREEMENT AND DISCLAIMER:

The measured data in the provided downloadable LEDiL Product Datasheets and Mechanical 2D-Drawings is rounded and provided as reference for planning. LEDiL Oy's optical specifications have been verified by conducting performance testing of the products in accordance with the company's quality system. The reported data are averaged results of multiple measurements with typical variation. LEDiL Oy reserves the right to without prior notification make changes and improvements to its products.

LEDiL Oy assumes neither warranty, nor guarantee nor any other liability of any kind for the contents and correctness of the provided data. The provided data has been generated with highest diligence but the provided data may in reality not represent the complete possible variation range of all intrinsic parameters. Therefore, in certain cases a deviation from the provided data could occur.

LEDiL Oy reserves the right to undertake technical changes of its products without further notification which could lead to changes in the provided data. LEDiL Oy assumes no liability of any kind for the possible deviation from any provided data or any other damage resulting from the usage of the provided data.

The user agrees to this disclaimer and user agreement with the download or usage of the provided files.

LEDiL Oy

Joensuunkatu 13
FI-24240 SALO
Finland

LEDiL Inc.

228 West Page Street
Suite D
Sycamore IL 60178
USA

Ledil Optics Technology (Shenzhen) Co., Ltd.

405 , Block B
Casic Motor Building
Shenzhen 518057
P.R.CHINA

Local sales and technical support

[www.ledil.com/
where_to_buy](http://www.ledil.com/where_to_buy)

Shipping locations

Salo, Finland
Hong Kong, China

Distribution Partners

[www.ledil.com/
where_to_buy](http://www.ledil.com/where_to_buy)