

MIRELLA-50-W-PF

~40° wide beam

TECHNICAL SPECIFICATIONS:

Dimensions	Ø 49.9 mm
Height	24 mm
Fastening	socket
ROHS compliant	yes ⓘ

MATERIAL SPECIFICATIONS:

Component	Type	Material	Colour	Finish	Coating
MIRELLA-50-W-PF	Reflector	PC	metal		lacquer

ORDERING INFORMATION:





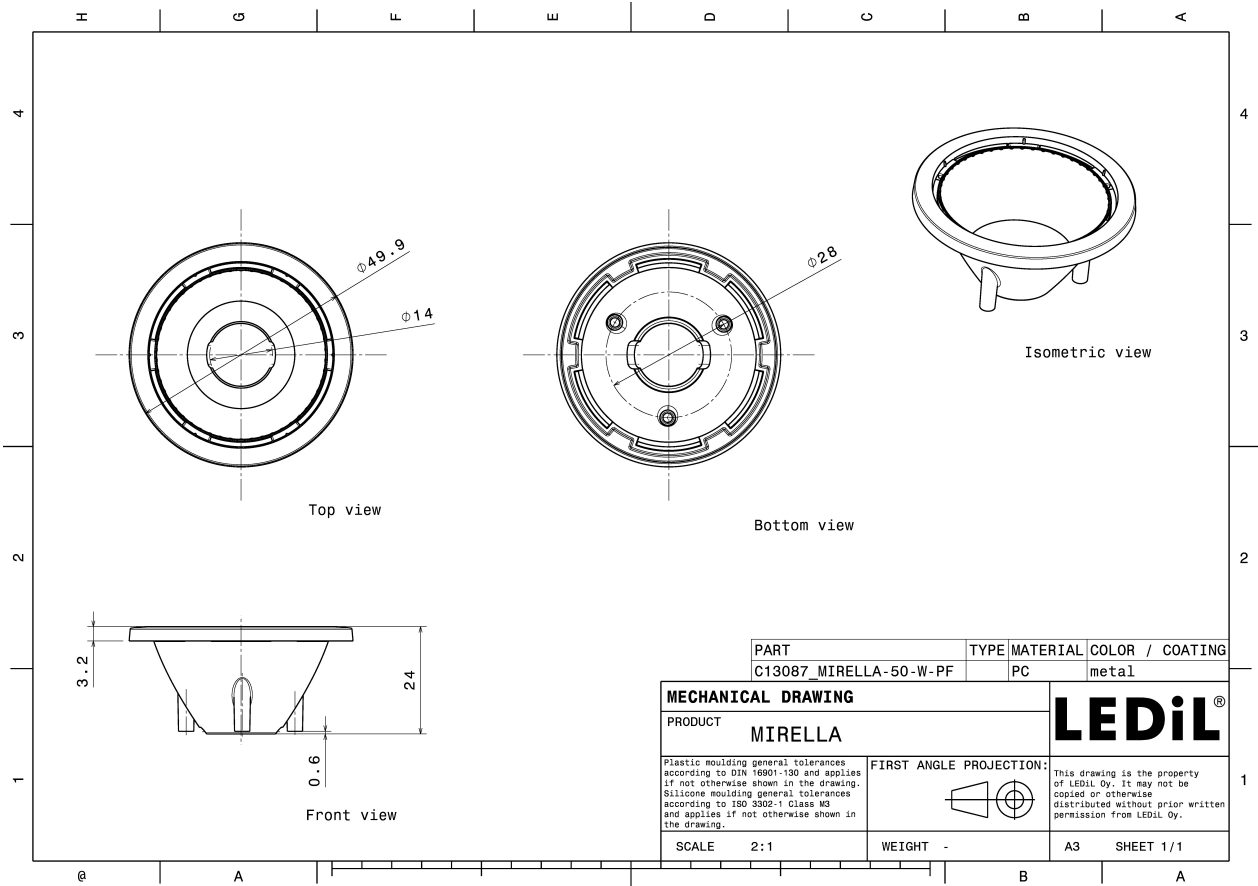

Component	Qty in box	MOQ	MPQ	Box weight (kg)
C13087_MIRELLA-50-W-PF » Box size: 480 x 280 x 300 mm	336	112	28	2.8



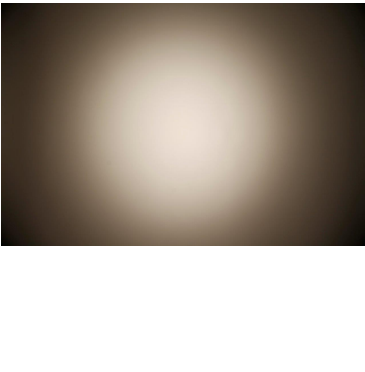
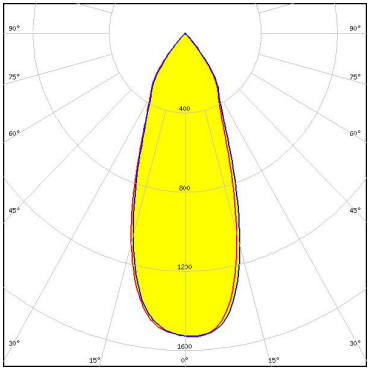

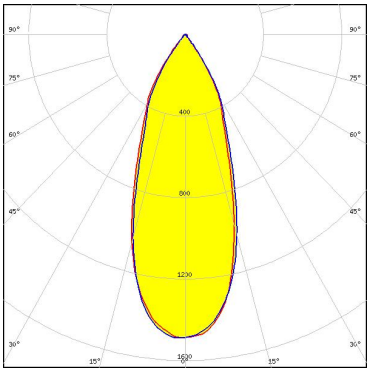

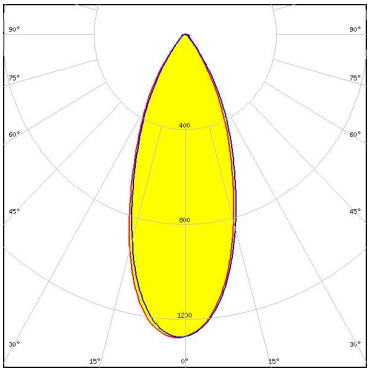
See also our general installation guide: www.ledil.com/installation_guide

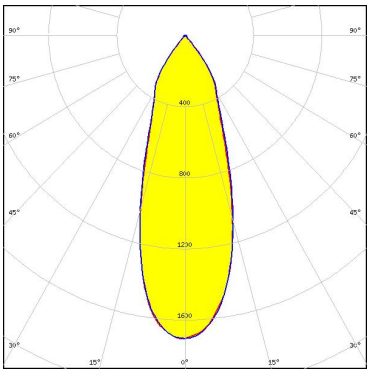

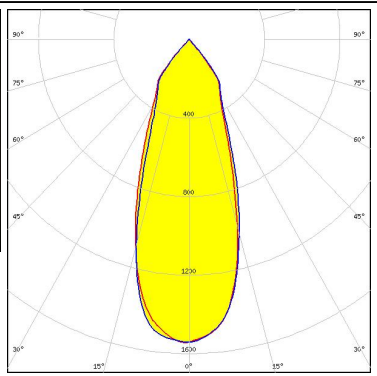
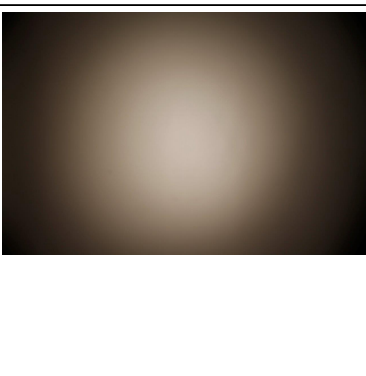
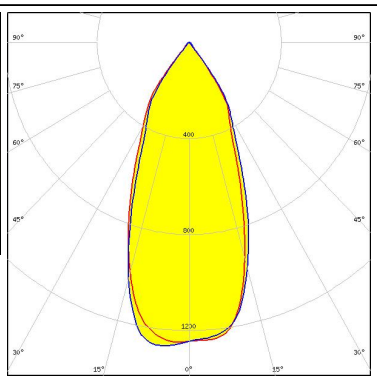

PHOTOMETRIC DATA (MEASURED):

<p></p> <p>LED V10 Gen6 FWHM / FWTM 39.0° / 79.0° Efficiency 86 % Peak intensity 1.5 cd/m LEDs/each optic 1 Light colour White Required components: C14115_PF-SOCKET-CXA15-18</p>		
<p></p> <p>LED V10 Gen7 FWHM / FWTM 39.0° / 73.0° Efficiency 79 % Peak intensity 1.5 cd/m LEDs/each optic 1 Light colour White Required components: C13709_PF-SOCKET-VERO13-18 C13333_MIRELLA-CL</p>		
<p></p> <p>LED V10 Gen7 FWHM / FWTM 40.0° / 75.0° Efficiency 77 % Peak intensity 1.3 cd/m LEDs/each optic 1 Light colour White Required components: C13709_PF-SOCKET-VERO13-18 C12479_MIRELLA-DL</p>		
<p></p> <p>LED V10 Gen7 FWHM / FWTM 35.0° / 76.0° Efficiency 84 % Peak intensity 1.7 cd/m LEDs/each optic 1 Light colour White Required components: C13709_PF-SOCKET-VERO13-18</p>		

PHOTOMETRIC DATA (MEASURED):

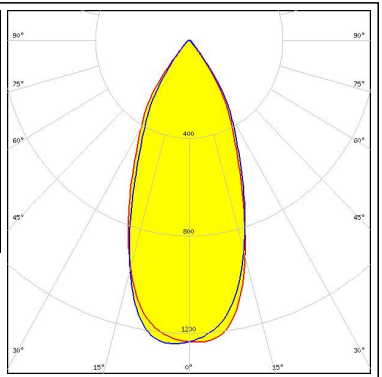
<p>bridgelux.</p> <p>LED V6 Gen6</p> <p>FWHM / FWTM 31.0° / 72.0°</p> <p>Efficiency 74 %</p> <p>Peak intensity 2.1 cd/lm</p> <p>LEDs/each optic 1</p> <p>Light colour White</p> <p>Required components:</p> <p>C13709_PF-SOCKET-VERO13-18</p> <p>C12479_MIRELLA-DL</p> <p>Bender Wirth: 460 Typ L1</p>		
<p>bridgelux.</p> <p>LED V6 Gen6</p> <p>FWHM / FWTM 27.0° / 76.0°</p> <p>Efficiency 82 %</p> <p>Peak intensity 2.7 cd/lm</p> <p>LEDs/each optic 1</p> <p>Light colour White</p> <p>Required components:</p> <p>C13709_PF-SOCKET-VERO13-18</p> <p>Bender Wirth: 460 Typ L1</p>		
<p>bridgelux.</p> <p>LED V6 Gen6</p> <p>FWHM / FWTM 39.0° / 81.0°</p> <p>Efficiency 87 %</p> <p>Peak intensity 1.5 cd/lm</p> <p>LEDs/each optic 1</p> <p>Light colour White</p> <p>Required components:</p> <p>C13761_PF-SOCKET-CXA15</p>		
<p>bridgelux.</p> <p>LED V6 Gen6</p> <p>FWHM / FWTM 44.0° / 77.0°</p> <p>Efficiency 81 %</p> <p>Peak intensity 1.3 cd/lm</p> <p>LEDs/each optic 1</p> <p>Light colour White</p> <p>Required components:</p> <p>C13761_PF-SOCKET-CXA15</p> <p>C13333_MIRELLA-CL</p>		

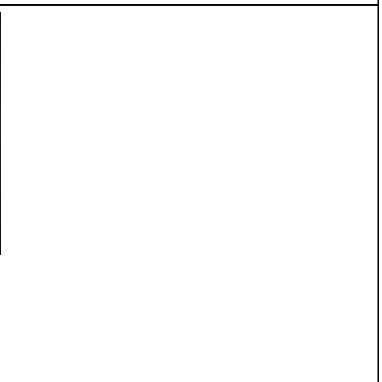
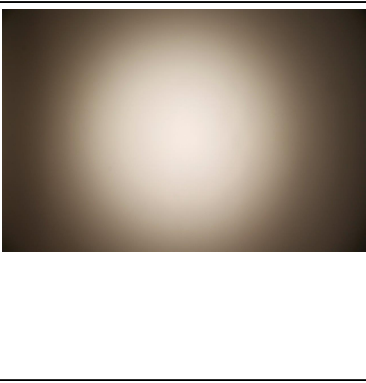
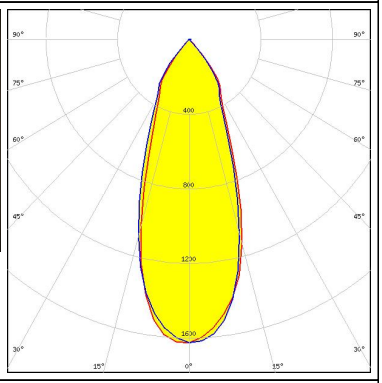
PHOTOMETRIC DATA (MEASURED):

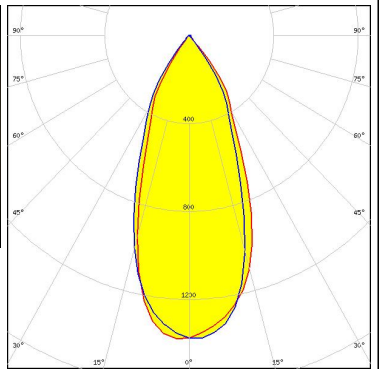
<p>bridgelux.</p> <p>LED V6 Gen6 FWHM / FWTM 44.0° / 78.0° Efficiency 81 % Peak intensity 1.3 cd/lm LEDs/each optic 1 Light colour White</p> <p>Required components: C13761_PF-SOCKET-CXA15 C12479_MIRELLA-DL</p>		
<p>bridgelux.</p> <p>LED V8 Gen6 FWHM / FWTM 36.0° / 74.0° Efficiency 73 % Peak intensity 1.8 cd/lm LEDs/each optic 1 Light colour White</p> <p>Required components: C13709_PF-SOCKET-VERO13-18 C12479_MIRELLA-DL Bender Wirth: 460 Typ L1</p>		
<p>bridgelux.</p> <p>LED V8 Gen6 FWHM / FWTM 38.0° / 79.0° Efficiency 87 % Peak intensity 1.6 cd/lm LEDs/each optic 1 Light colour White</p> <p>Required components: C13761_PF-SOCKET-CXA15</p>		
<p>bridgelux.</p> <p>LED V8 Gen6 FWHM / FWTM 42.0° / 76.0° Efficiency 82 % Peak intensity 1.4 cd/lm LEDs/each optic 1 Light colour White</p> <p>Required components: C13761_PF-SOCKET-CXA15 C13333_MIRELLA-CL</p>		

PHOTOMETRIC DATA (MEASURED):

bridgelux.

LED	V8 Gen6
FWHM / FWTM	43.0° / 76.0°
Efficiency	82 %
Peak intensity	1.3 cd/lm
LEDs/each optic	1
Light colour	White

Required components:
 C13761_PF-SOCKET-CXA15
 C12479_MIRELLA-DL

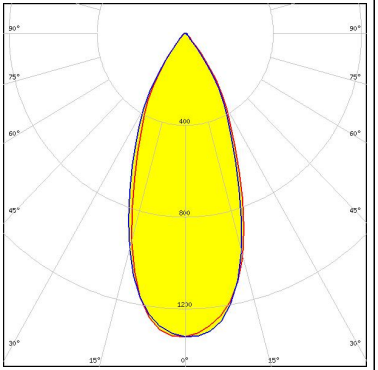

bridgelux.

LED	VERO10
FWHM / FWTM	44.0° / 76.0°
Efficiency	80 %
Peak intensity	1.3 cd/lm
LEDs/each optic	1
Light colour	White

Required components:
 C13708_PF-SOCKET-VERO10
 C13333_MIRELLA-CL

bridgelux.

LED	VERO10
FWHM / FWTM	40.0° / 79.0°
Efficiency	85 %
Peak intensity	1.5 cd/lm
LEDs/each optic	1
Light colour	White

Required components:
 C13708_PF-SOCKET-VERO10

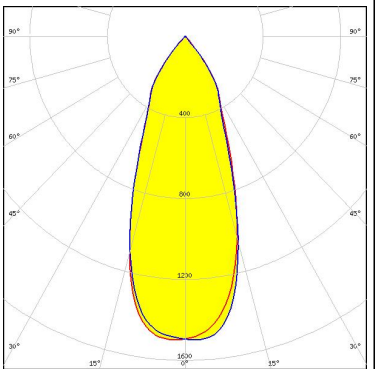







bridgelux.

LED	VERO10
FWHM / FWTM	44.0° / 76.0°
Efficiency	80 %
Peak intensity	1.3 cd/lm
LEDs/each optic	1
Light colour	White

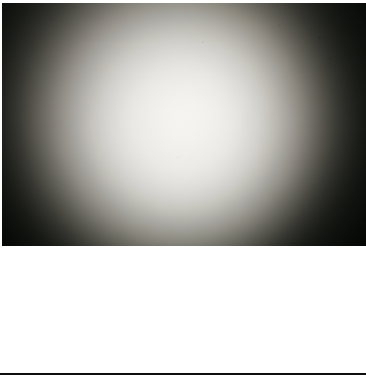
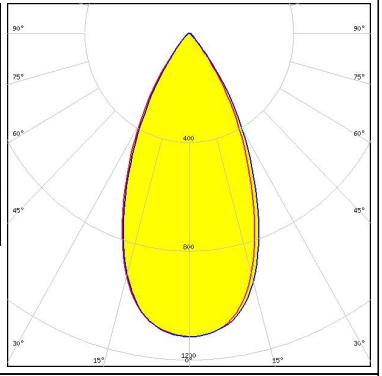
Required components:
 C13708_PF-SOCKET-VERO10
 C12479_MIRELLA-DL

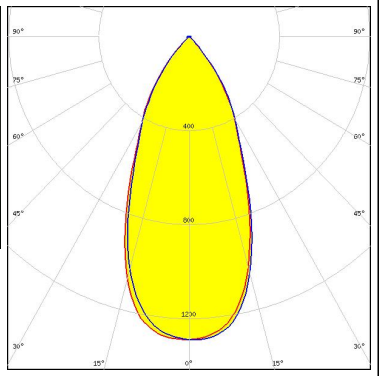

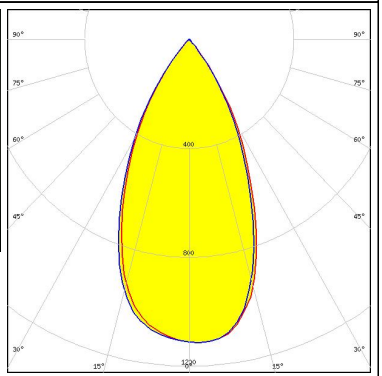
PHOTOMETRIC DATA (MEASURED):

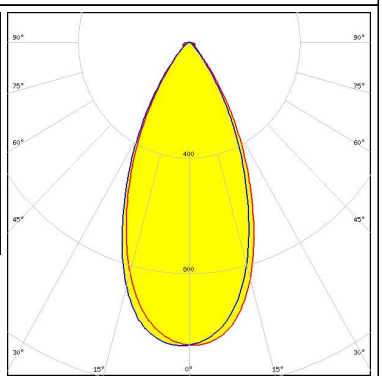
<p>bridgelux.</p> <p>LED VERO13 FWHM / FWTM 50.0° / 79.0° Efficiency 82 % Peak intensity 1.1 cd/lm LEDs/each optic 1 Light colour White</p> <p>Required components: C13709_PF-SOCKET-VERO13-18 C12479_MIRELLA-DL</p>		
<p>bridgelux.</p> <p>LED VERO13 FWHM / FWTM 46.0° / 82.0° Efficiency 90 % Peak intensity 1.3 cd/lm LEDs/each optic 1 Light colour White</p> <p>Required components: C13709_PF-SOCKET-VERO13-18</p>		
<p>bridgelux.</p> <p>LED VERO13 FWHM / FWTM 51.0° / 79.0° Efficiency 77 % Peak intensity 1.1 cd/lm LEDs/each optic 1 Light colour White</p> <p>Required components: C13709_PF-SOCKET-VERO13-18 C13333_MIRELLA-CL</p>		
<p>bridgelux.</p> <p>LED Xenio Point 13mm FWHM / FWTM 48.0° / 80.0° Efficiency 78 % Peak intensity 1.1 cd/lm LEDs/each optic 1 Light colour White</p> <p>Required components: C13709_PF-SOCKET-VERO13-18 C12479_MIRELLA-DL</p>		

PHOTOMETRIC DATA (MEASURED):

bridgelux.

LED Xenio Point 13mm
 FWHM / FWTM 45.0° / 81.0°
 Efficiency 85 %
 Peak intensity 1.3 cd/lm
 LEDs/each optic 1
 Light colour White
 Required components:
 C13709_PF-SOCKET-VERO13-18



bridgelux.

LED Xenio Point 13mm
 FWHM / FWTM 49.0° / 78.0°
 Efficiency 81 %
 Peak intensity 1.1 cd/lm
 LEDs/each optic 1
 Light colour White
 Required components:
 C13709_PF-SOCKET-VERO13-18
 C13333_MIRELLA-CL



CITIZEN

LED CLL01x
 FWHM / FWTM 42.0° / 76.0°
 Efficiency 86 %
 Peak intensity 1.4 cd/lm
 LEDs/each optic 1
 Light colour White
 Required components:
 C13083_PF-SOCKET
 C13333_MIRELLA-CL



CITIZEN

LED CLL01x
 FWHM / FWTM 36.0° / 80.0°
 Efficiency 90 %
 Peak intensity 1.8 cd/lm
 LEDs/each optic 1
 Light colour White
 Required components:
 C13083_PF-SOCKET



PHOTOMETRIC DATA (MEASURED):

CITIZEN

LED CLL01x
 FWHM / FWTM 44.0° / 76.0°
 Efficiency 86 %
 Peak intensity 1.4 cd/lm
 LEDs/each optic 1
 Light colour White
 Required components:
 C13083_PF-SOCKET
 C12479_MIRELLA-DL



CITIZEN

LED CLL02x/CLU02x (LES10)
 FWHM / FWTM 46.0° / 78.0°
 Efficiency 86 %
 Peak intensity 1.5 cd/lm
 LEDs/each optic 1
 Light colour White
 Required components:
 C13083_PF-SOCKET
 C13333_MIRELLA-CL

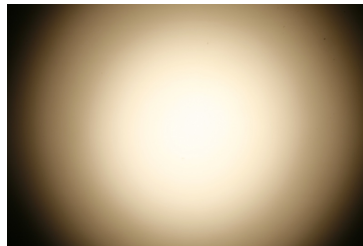

CITIZEN

LED CLL02x/CLU02x (LES10)
 FWHM / FWTM 46.0° / 80.0°
 Efficiency %
 Peak intensity 0.7 cd/lm
 LEDs/each optic 1
 Light colour White
 Required components:
 C13083_PF-SOCKET
 C13723_MIRELLA-RZL

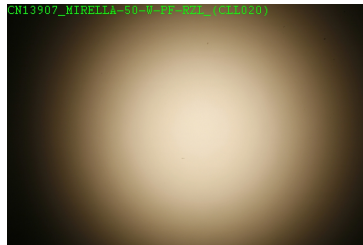

CITIZEN

LED CLL02x/CLU02x (LES10)
 FWHM / FWTM 41.0° / 76.0°
 Efficiency 76 %
 Peak intensity 1.3 cd/lm
 LEDs/each optic 1
 Light colour White
 Required components:
 C13709_PF-SOCKET-VERO13-18
 C12479_MIRELLA-DL
 Bender Wirth: 434 Typ L1

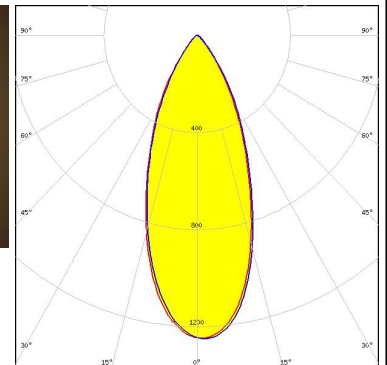
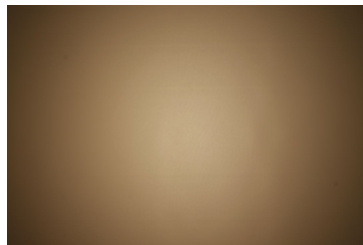

PHOTOMETRIC DATA (MEASURED):

CITIZEN

LED CLL02x/CLU02x (LES10)
 FWHM / FWTM 36.0° / 77.0°
 Efficiency 84 %
 Peak intensity 1.7 cd/lm
 LEDs/each optic 1
 Light colour White
 Required components:
 C13709_PF-SOCKET-VERO13-18
 Bender Wirth: 434 Typ L1

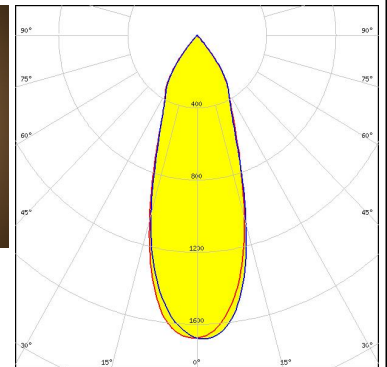
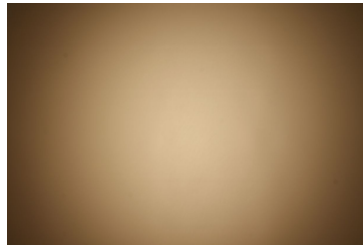

CITIZEN

LED CLL02x/CLU02x (LES10)
 FWHM / FWTM 41.0° / 80.0°
 Efficiency 90 %
 Peak intensity 1.8 cd/lm
 LEDs/each optic 1
 Light colour White
 Required components:
 C13083_PF-SOCKET

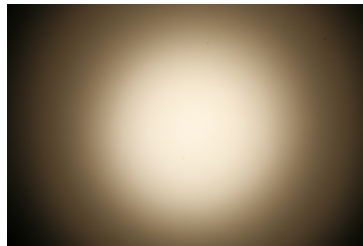

CITIZEN

LED CLL02x/CLU02x (LES10)
 FWHM / FWTM 46.0° / 77.0°
 Efficiency 86 %
 Peak intensity 1.5 cd/lm
 LEDs/each optic 1
 Light colour White
 Required components:
 C13083_PF-SOCKET
 C12479_MIRELLA-DL

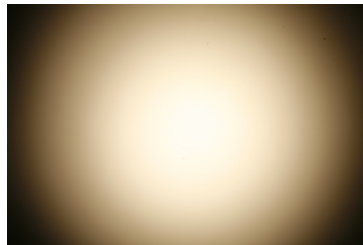

CITIZEN

LED CLL02x/CLU02x (LES10)
 FWHM / FWTM 39.0° / 73.0°
 Efficiency 78 %
 Peak intensity 1.5 cd/lm
 LEDs/each optic 1
 Light colour White
 Required components:
 C13709_PF-SOCKET-VERO13-18
 C13333_MIRELLA-CL
 Bender Wirth: 434 Typ L1

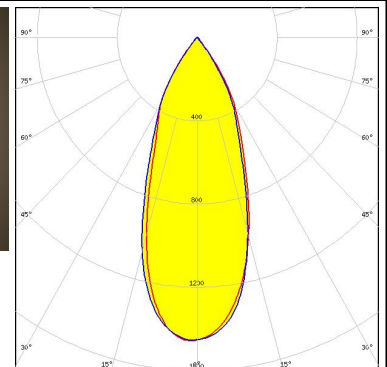
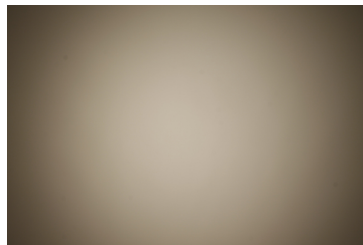

PHOTOMETRIC DATA (MEASURED):

CITIZEN

LED CLU700/701/702
 FWHM / FWTM 33.0° / 78.0°
 Efficiency 88 %
 Peak intensity 1.9 cd/lm
 LEDs/each optic 1
 Light colour White
 Required components:
 C13083_PF-SOCKET

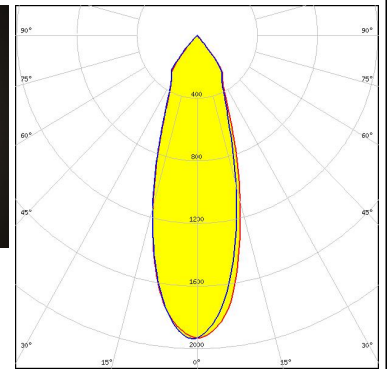
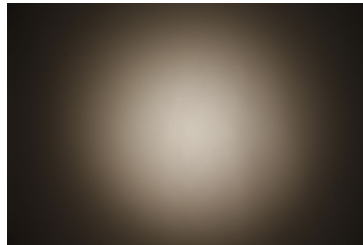

CITIZEN

LED CLU700/701/702
 FWHM / FWTM 39.0° / 75.0°
 Efficiency 82 %
 Peak intensity 1.4 cd/lm
 LEDs/each optic 1
 Light colour White
 Required components:
 C13083_PF-SOCKET
 C12479_MIRELLA-DL

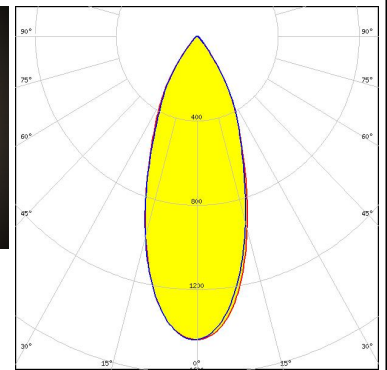
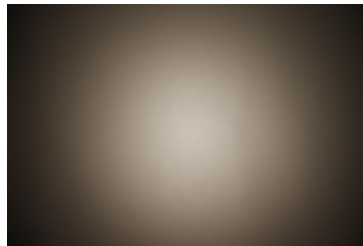

CITIZEN

LED CLU700/701/702
 FWHM / FWTM 34.0° / 72.0°
 Efficiency 81 %
 Peak intensity 1.8 cd/lm
 LEDs/each optic 1
 Light colour White
 Required components:
 C13083_PF-SOCKET
 C13333_MIRELLA-CL

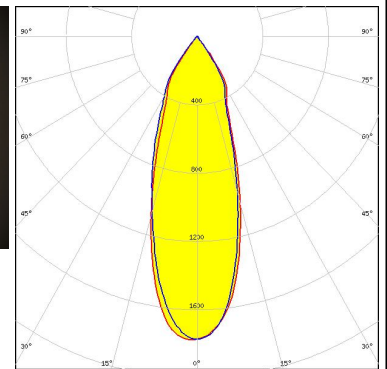
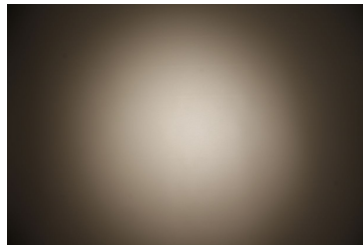

CITIZEN

LED CLU700/701/702
 FWHM / FWTM 42.0° / 78.0°
 Efficiency 81 %
 Peak intensity 1.3 cd/lm
 LEDs/each optic 1
 Light colour White
 Required components:
 C13083_PF-SOCKET
 C13723_MIRELLA-RZL

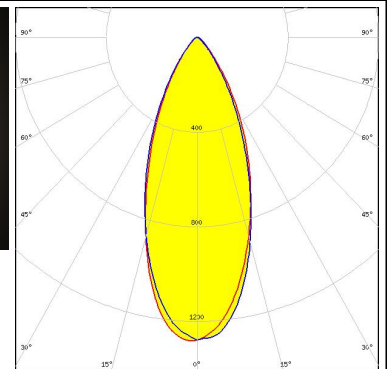
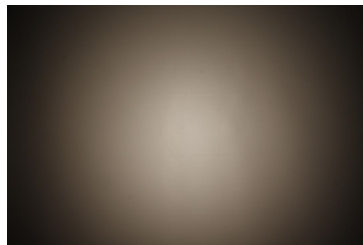

PHOTOMETRIC DATA (MEASURED):

CITIZEN

LED CLU700/701/702
 FWHM / FWTM 31.0° / 70.0°
 Efficiency 77 %
 Peak intensity 1.8 cd/lm
 LEDs/each optic 1
 Light colour White
 Required components:
 C13709_PF-SOCKET-VERO13-18
 C12479_MIRELLA-DL
 Bender Wirth: 434 Typ L1

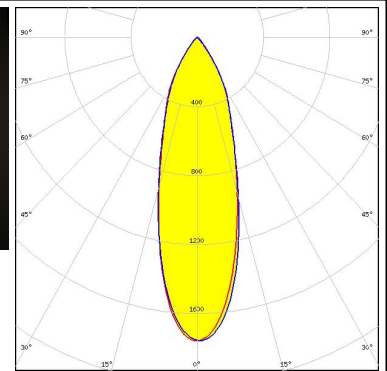
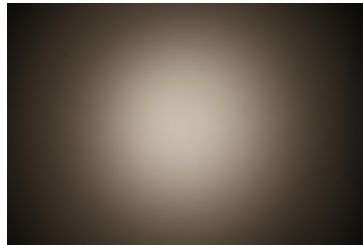

CITIZEN

LED CLU700/701/702
 FWHM / FWTM 26.0° / 73.0°
 Efficiency 83 %
 Peak intensity 2.4 cd/lm
 LEDs/each optic 1
 Light colour White
 Required components:
 C13709_PF-SOCKET-VERO13-18
 Bender Wirth: 434 Typ L1

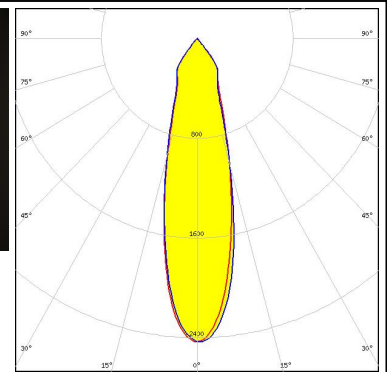
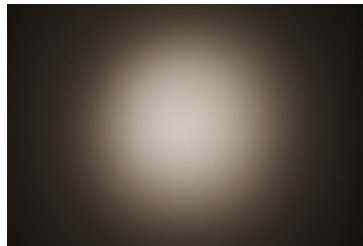

CITIZEN

LED CLU700/701/702
 FWHM / FWTM 29.0° / 69.0°
 Efficiency 80 %
 Peak intensity 2.1 cd/lm
 LEDs/each optic 1
 Light colour White
 Required components:
 C13709_PF-SOCKET-VERO13-18
 C13333_MIRELLA-CL
 Bender Wirth: 434 Typ L1

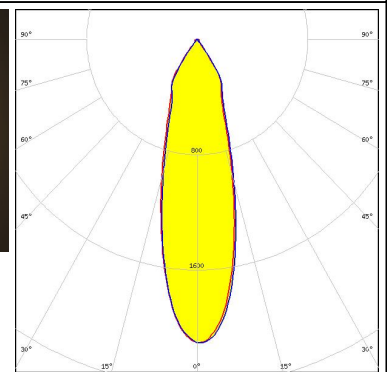
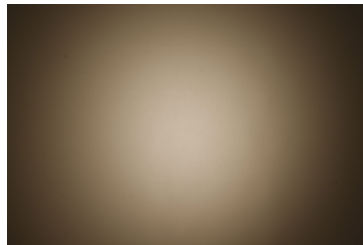

CITIZEN

LED CLU720/721
 FWHM / FWTM 43.0° / 74.0°
 Efficiency 76 %
 Peak intensity 1.3 cd/lm
 LEDs/each optic 1
 Light colour White
 Required components:
 C13709_PF-SOCKET-VERO13-18
 C13333_MIRELLA-CL
 Bender Wirth: 433 Typ L1

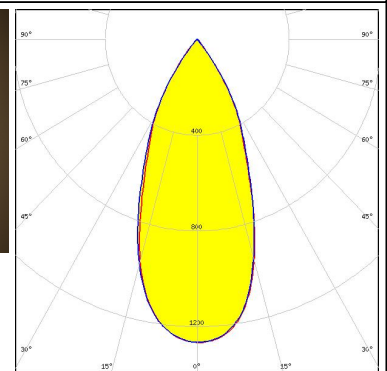
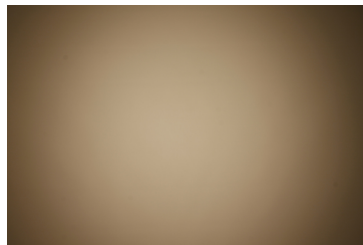

PHOTOMETRIC DATA (MEASURED):

CITIZEN

LED CLU720/721
 FWHM / FWTM 44.0° / 78.0°
 Efficiency 74 %
 Peak intensity 1.1 cd/lm
 LEDs/each optic 1
 Light colour White

Required components:

C13709_PF-SOCKET-VERO13-18
 C12479_MIRELLA-DL
 Bender Wirth: 433 Typ L1

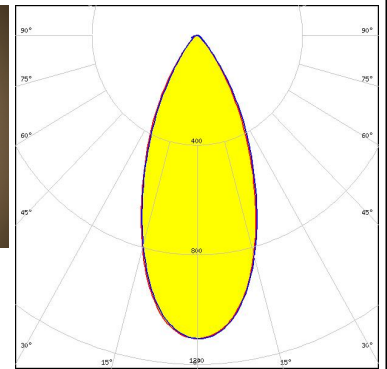

CITIZEN

LED CLU720/721
 FWHM / FWTM 40.0° / 78.0°
 Efficiency 81 %
 Peak intensity 1.4 cd/lm
 LEDs/each optic 1
 Light colour White

Required components:

C13709_PF-SOCKET-VERO13-18
 Bender Wirth: 433 Typ L1

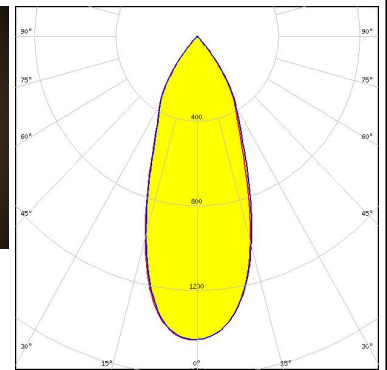
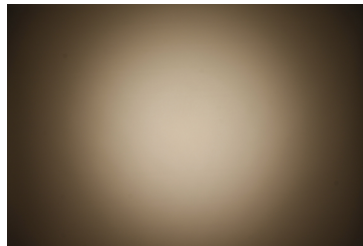

CREE LED

LED CXA/B 13xx
 FWHM / FWTM 37.0° / 80.0°
 Efficiency 86 %
 Peak intensity 1.8 cd/lm
 LEDs/each optic 1
 Light colour White

Required components:

C13761_PF-SOCKET-CXA15

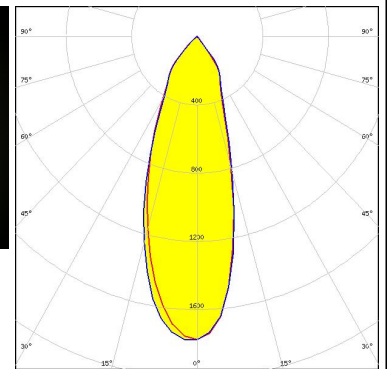
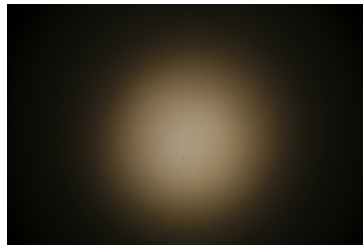

CREE LED



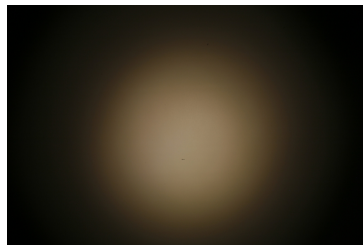

LED CXA/B 13xx
 FWHM / FWTM 42.0° / 76.0°
 Efficiency 81 %
 Peak intensity 1.5 cd/lm
 LEDs/each optic 1
 Light colour White

Required components:

C13761_PF-SOCKET-CXA15
 C13333_MIRELLA-CL

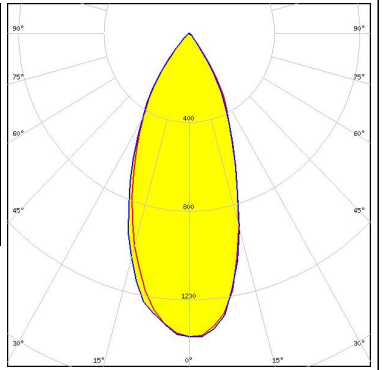

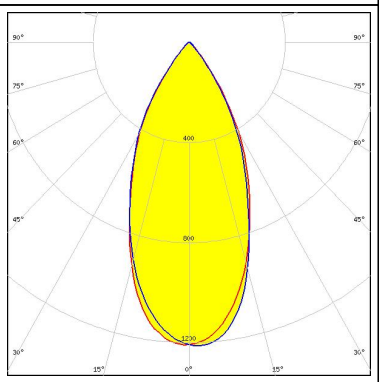
PHOTOMETRIC DATA (MEASURED):

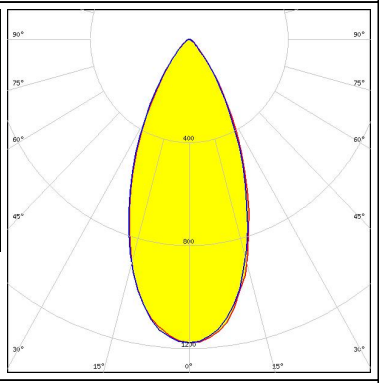
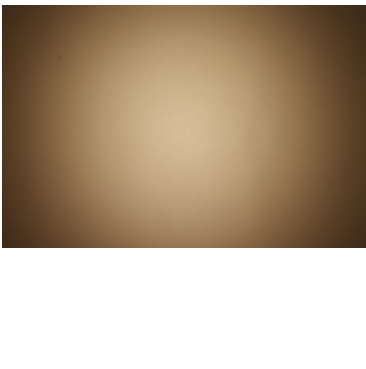
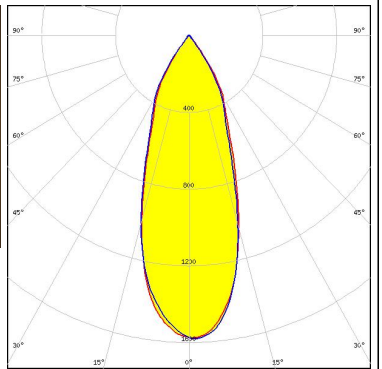
<p>CREE LED</p> <p>LED CXA/B 13xx FWHM / FWTM 43.0° / 76.0° Efficiency 81 % Peak intensity 1.4 cd/lm LEDs/each optic 1 Light colour White</p> <p>Required components: C13761_PF-SOCKET-CXA15 C12479_MIRELLA-DL</p>		
<p>CREE LED</p> <p>LED CXA/B 15xx FWHM / FWTM 47.0° / 79.0° Efficiency 85 % Peak intensity 1.2 cd/lm LEDs/each optic 1 Light colour White</p> <p>Required components: C13761_PF-SOCKET-CXA15 C12479_MIRELLA-DL</p>		
<p>CREE LED</p> <p>LED CXA/B 15xx FWHM / FWTM 47.0° / 81.0° Efficiency 81 % Peak intensity 1.2 cd/lm LEDs/each optic 1 Light colour White</p> <p>Required components: C13761_PF-SOCKET-CXA15 C13723_MIRELLA-RZL</p>		
<p>CREE LED</p> <p>LED CXA/B 15xx FWHM / FWTM 37.0° / 72.0° Efficiency 79 % Peak intensity 1.6 cd/lm LEDs/each optic 1 Light colour White</p> <p>Required components: C13709_PF-SOCKET-VERO13-18 C13333_MIRELLA-CL Bender Wirth: 441 Typ L1</p>		

PHOTOMETRIC DATA (MEASURED):



LED CXA/B 15xx
 FWHM / FWTM 41.0° / 82.0°
 Efficiency 90 %
 Peak intensity 1.4 cd/lm
 LEDs/each optic 1
 Light colour White
 Required components:
 C13761_PF-SOCKET-CXA15

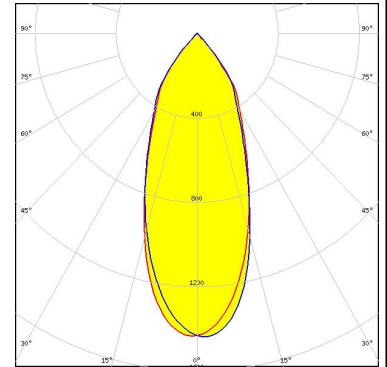

LED CXA/B 15xx
 FWHM / FWTM 39.0° / 75.0°
 Efficiency 75 %
 Peak intensity 1.3 cd/lm
 LEDs/each optic 1
 Light colour White
 Required components:
 C13709_PF-SOCKET-VERO13-18
 C12479_MIRELLA-DL
 Bender Wirth: 441 Typ L1

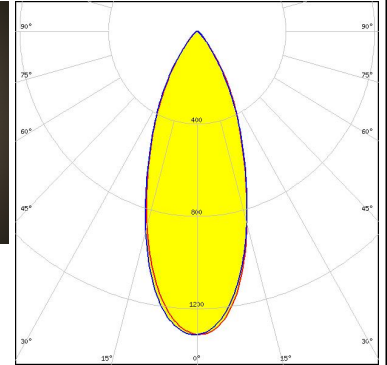
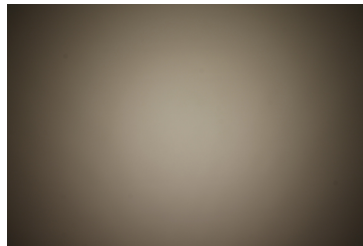

LED CXA/B 15xx
 FWHM / FWTM 46.0° / 79.0°
 Efficiency 85 %
 Peak intensity 1.4 cd/lm
 LEDs/each optic 1
 Light colour White
 Required components:
 C13761_PF-SOCKET-CXA15
 C13333_MIRELLA-CL

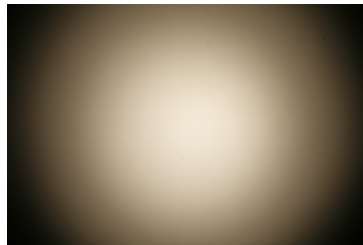

LED CXA/B 15xx
 FWHM / FWTM 34.0° / 75.0°
 Efficiency 82 %
 Peak intensity 1.8 cd/lm
 LEDs/each optic 1
 Light colour White
 Required components:
 C13709_PF-SOCKET-VERO13-18
 Bender Wirth: 441 Typ L1

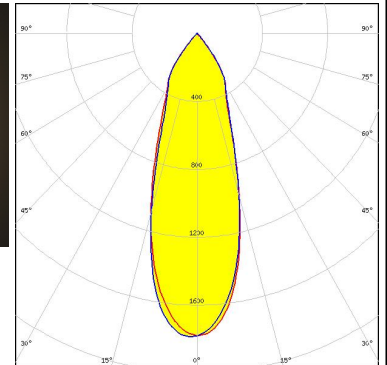
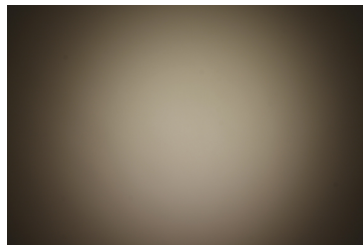

PHOTOMETRIC DATA (MEASURED):

CREE LED

LED CXA/B 1816 & CXA/B 1820 & CXA 1850
 FWHM / FWTM 43.0° / 81.0°
 Efficiency 87 %
 Peak intensity 1.4 cd/lm
 LEDs/each optic 1
 Light colour White
 Required components:
 IDEAL: 50-2101CR + 50-2100MR

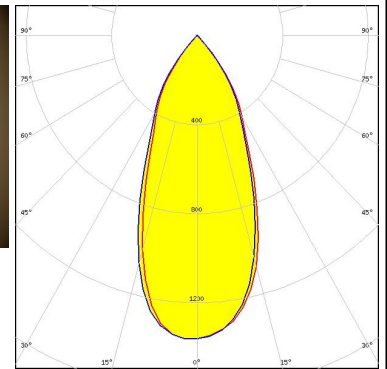
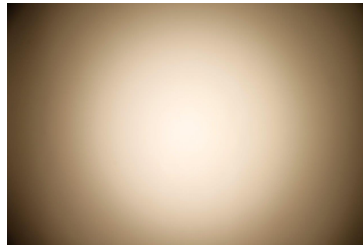

CREE LED

LED CXA/B 1816 & CXA/B 1820 & CXA 1850
 FWHM / FWTM 45.0° / 81.0°
 Efficiency 84 %
 Peak intensity 1.3 cd/lm
 LEDs/each optic 1
 Light colour White
 Required components:
 C14115_PF-SOCKET-CXA15-18

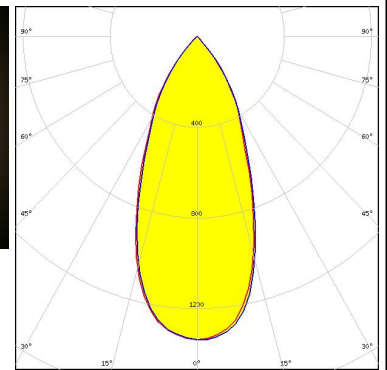
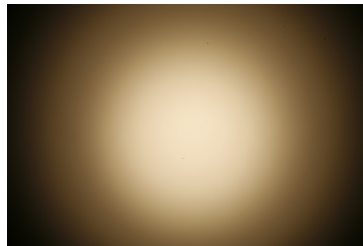

CREE LED

LED MHD-E/G
 FWHM / FWTM 38.0° / 82.0°
 Efficiency 89 %
 Peak intensity 1.5 cd/lm
 LEDs/each optic 1
 Light colour White
 Required components:
 C13083_PF-SOCKET

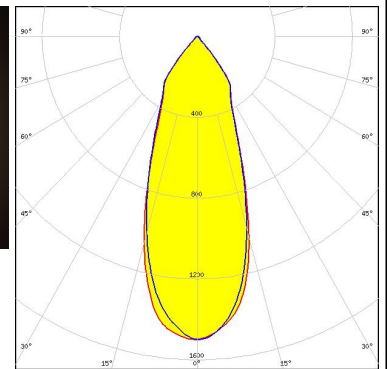
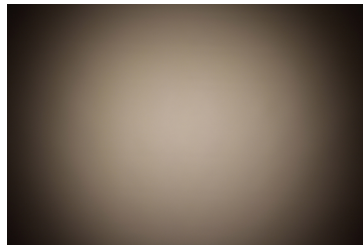





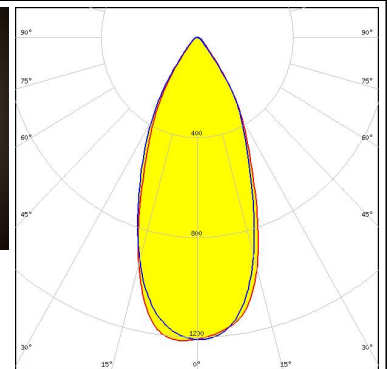
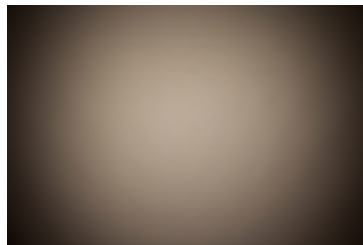

CREE LED

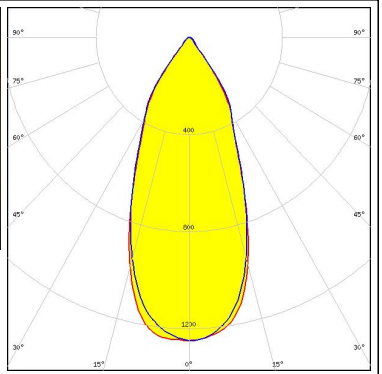

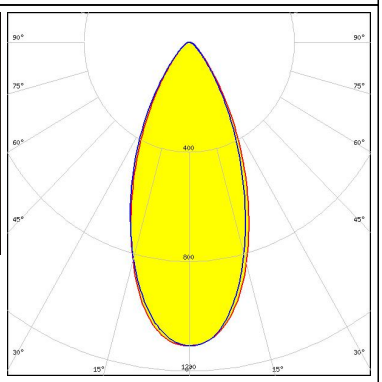

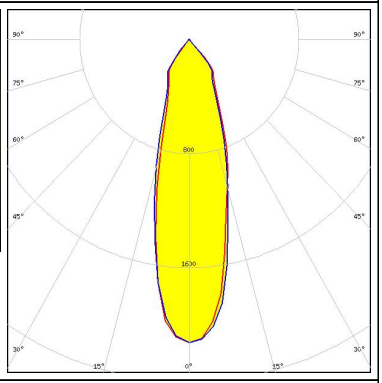

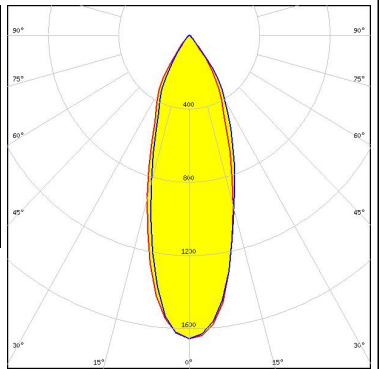
LED MHD-E/G
 FWHM / FWTM 45.0° / 78.0°
 Efficiency 84 %
 Peak intensity 1.2 cd/lm
 LEDs/each optic 1
 Light colour White
 Required components:
 C13083_PF-SOCKET
 C12479_MIRELLA-DL

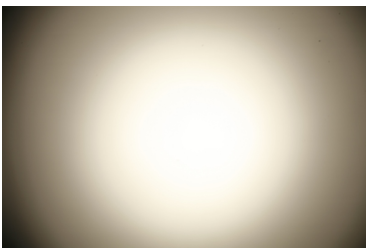

PHOTOMETRIC DATA (MEASURED):

<p>CREE → LED</p> <p>LED MHD-E/G FWHM / FWTM 44.0° / 77.0° Efficiency 84 % Peak intensity 1.3 cd/lm LEDs/each optic 1 Light colour White</p> <p>Required components: C13083_PF-SOCKET C13333_MIRELLA-CL</p>		
<p>CREE → LED</p> <p>LED MHD-E/G FWHM / FWTM 45.0° / 83.0° Efficiency 82 % Peak intensity 1.1 cd/lm LEDs/each optic 1 Light colour White</p> <p>Required components: C13083_PF-SOCKET C13723_MIRELLA-RZL</p>		
<p>CREE → LED</p> <p>LED MK-R FWHM / FWTM 30.0° / 77.0° Efficiency 85 % Peak intensity 2.1 cd/lm LEDs/each optic 1 Light colour White</p> <p>Required components: C13083_PF-SOCKET</p>		
<p>CREE → LED</p> <p>LED MK-R FWHM / FWTM 34.0° / 73.0° Efficiency 80 % Peak intensity 1.7 cd/lm LEDs/each optic 1 Light colour White</p> <p>Required components: C13083_PF-SOCKET C12479_MIRELLA-DL</p>		

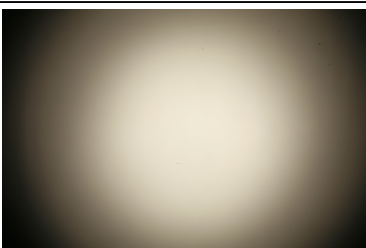
PHOTOMETRIC DATA (MEASURED):

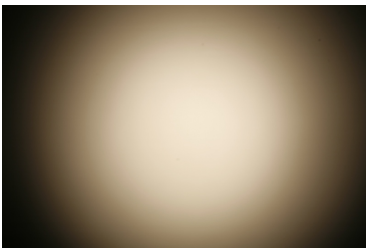
 LED MT-G FWHM / FWTM 52.0° / 84.0° Efficiency 86 % Peak intensity 1.2 cd/lm LEDs/each optic 1 Light colour White Required components: C13083_PF-SOCKET C12479_MIRELLA-DL	
 LED MT-G FWHM / FWTM 48.0° / 87.0° Efficiency 90 % Peak intensity 1.4 cd/lm LEDs/each optic 1 Light colour White Required components: C13083_PF-SOCKET	
 LED MT-G FWHM / FWTM 52.0° / 83.0° Efficiency 86 % Peak intensity 1.2 cd/lm LEDs/each optic 1 Light colour White Required components: C13083_PF-SOCKET C13333_MIRELLA-CL	
 LED MT-G2 FWHM / FWTM 51.0° / 82.0° Efficiency 87 % Peak intensity 1.2 cd/lm LEDs/each optic 1 Light colour White Required components: C13083_PF-SOCKET C12479_MIRELLA-DL	

PHOTOMETRIC DATA (MEASURED):



LED MT-G2
 FWHM / FWTM 46.0° / 86.0°
 Efficiency 91 %
 Peak intensity 0.8 cd/lm
 LEDs/each optic 1
 Light colour White
 Required components:
 C13083_PF-SOCKET

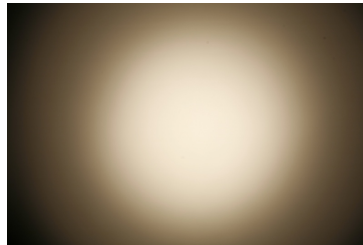

LED MT-G2
 FWHM / FWTM 50.0° / 81.0°
 Efficiency 87 %
 Peak intensity 1.2 cd/lm
 LEDs/each optic 1
 Light colour White
 Required components:
 C13083_PF-SOCKET
 C13333_MIRELLA-CL





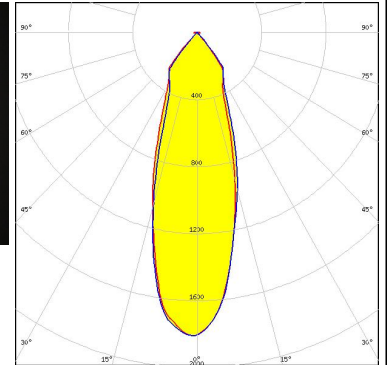
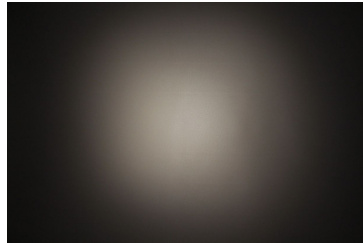

LED XHP50
 FWHM / FWTM 33.0° / 80.0°
 Efficiency 87 %
 Peak intensity 1.8 cd/lm
 LEDs/each optic 1
 Light colour White
 Required components:
 C13083_PF-SOCKET

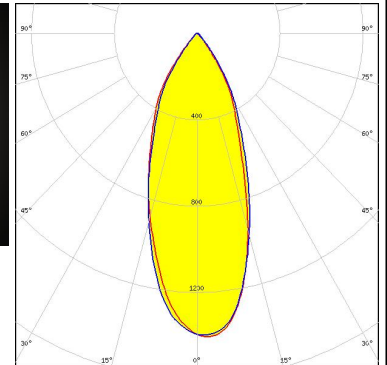
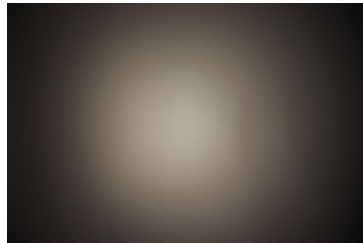



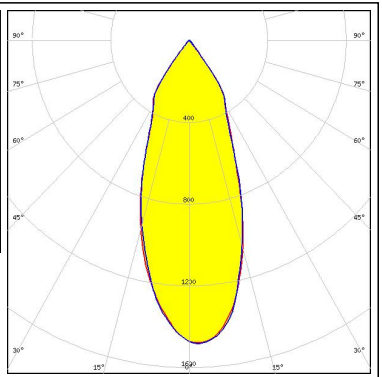

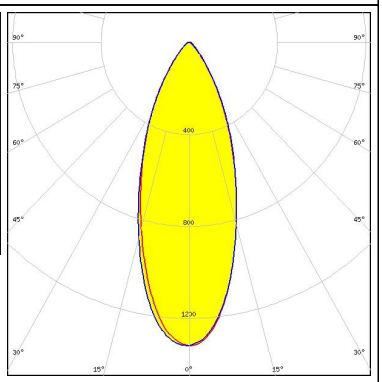
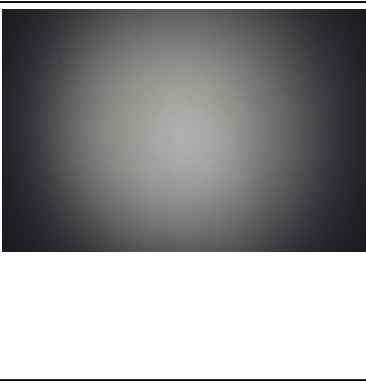
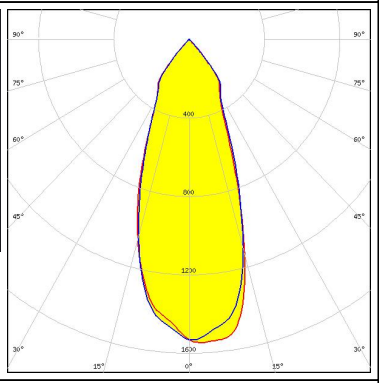

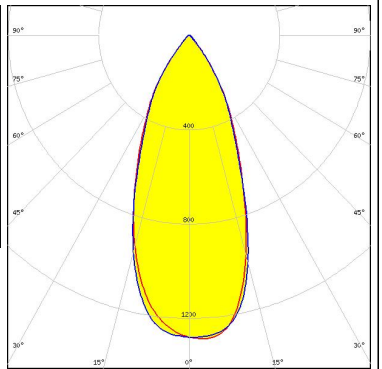

LED XHP50
 FWHM / FWTM 39.0° / 76.0°
 Efficiency 82 %
 Peak intensity 1.4 cd/lm
 LEDs/each optic 1
 Light colour White
 Required components:
 C13083_PF-SOCKET
 C12479_MIRELLA-DL

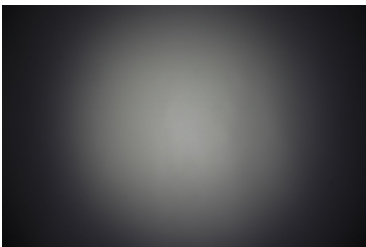
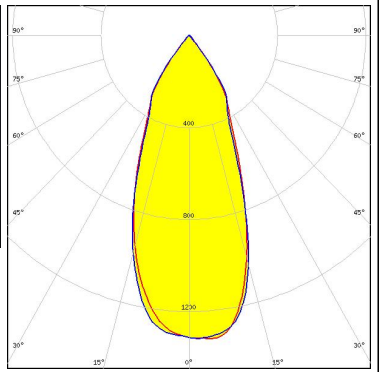

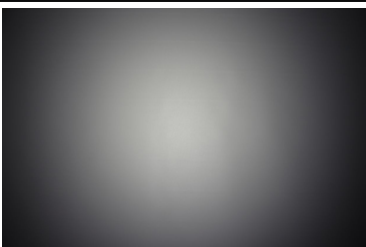
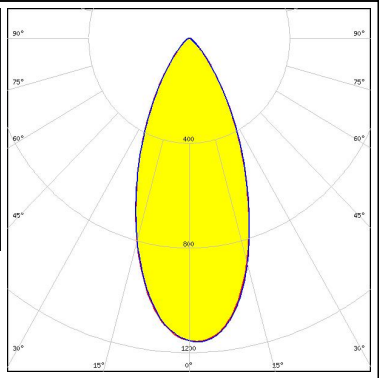

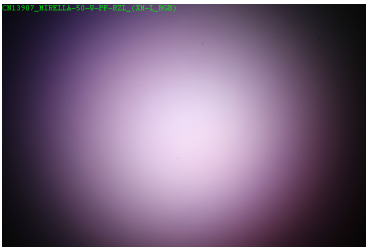
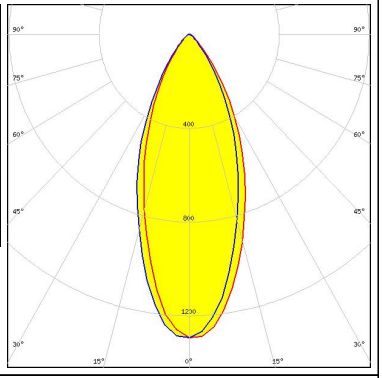
PHOTOMETRIC DATA (MEASURED):

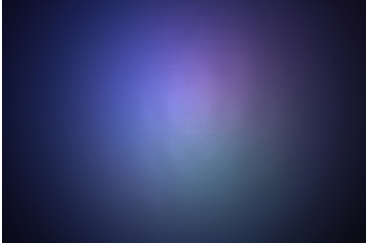
<p>CREE LED</p> <p>LED XHP50 FWHM / FWTM 39.0° / 76.0° Efficiency 81 % Peak intensity 1.5 cd/m LEDs/each optic 1 Light colour White</p> <p>Required components: C13083_PF-SOCKET C13333_MIRELLA-CL</p>		
<p>CREE LED</p> <p>LED XHP50 FWHM / FWTM 38.0° / 77.0° Efficiency 80 % Peak intensity 1.3 cd/m LEDs/each optic 1 Light colour White</p> <p>Required components: C13083_PF-SOCKET C13723_MIRELLA-RZL</p>		
<p>CREE LED</p> <p>LED XHP70 FWHM / FWTM 39.0° / 82.0° Efficiency 86 % Peak intensity 1.5 cd/m LEDs/each optic 1 Light colour White</p> <p>Required components: C13083_PF-SOCKET</p>		
<p>CREE LED</p> <p>LED XHP70 FWHM / FWTM 43.0° / 77.0° Efficiency 81 % Peak intensity 1.3 cd/m LEDs/each optic 1 Light colour White</p> <p>Required components: C13083_PF-SOCKET C12479_MIRELLA-DL</p>		

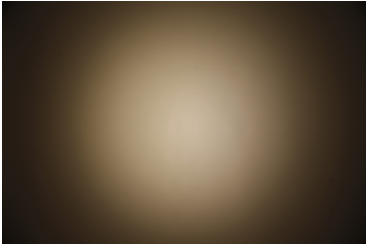
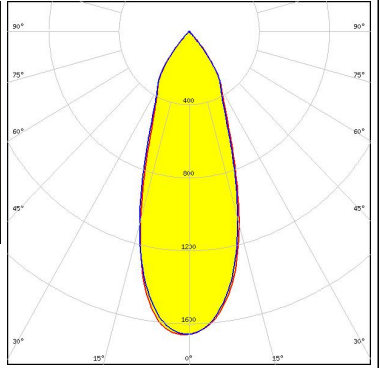
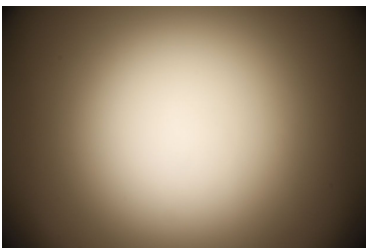
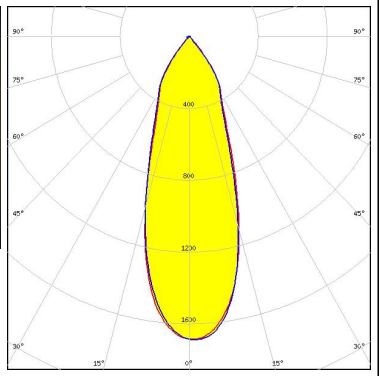

PHOTOMETRIC DATA (MEASURED):

<p>CREE  LED</p> <p>LED XHP70 FWHM / FWTM 42.0° / 77.0° Efficiency 81 % Peak intensity 1.3 cd/lm LEDs/each optic 1 Light colour White Required components: C13083_PF-SOCKET C13333_MIRELLA-CL</p>		
<p>CREE  LED</p> <p>LED XHP70 FWHM / FWTM 44.0° / 80.0° Efficiency 79 % Peak intensity 1.2 cd/lm LEDs/each optic 1 Light colour White Required components: C13083_PF-SOCKET C13723_MIRELLA-RZL</p>		
<p>CREE  LED</p> <p>LED XM-L RGB FWHM / FWTM 41.0° / 80.0° Efficiency 80 % Peak intensity 1.3 cd/lm LEDs/each optic 1 Light colour White Required components: C13083_PF-SOCKET C13723_MIRELLA-RZL</p>		
<p>CREE  LED</p> <p>LED XQ-E HI FWHM / FWTM 42.0° / 82.0° Efficiency 87 % Peak intensity 1.4 cd/lm LEDs/each optic 4 Light colour RGBW Required components: C13083_PF-SOCKET C13723_MIRELLA-RZL</p>		

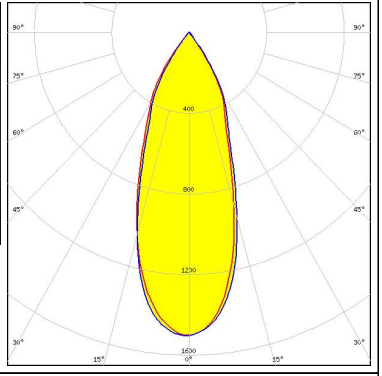
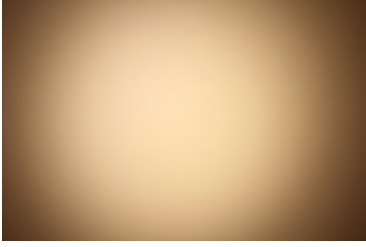
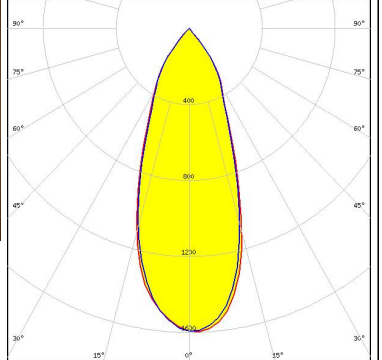
PHOTOMETRIC DATA (MEASURED):

<p>LUMILEDS</p> <p>LED LUXEON CoB 1202/1203</p> <p>FWHM / FWTM 37.0° / 78.0°</p> <p>Efficiency 87 %</p> <p>Peak intensity 1.7 cd/lm</p> <p>LEDs/each optic 1</p> <p>Light colour White</p> <p>Required components: IDEAL: 50-2100NC +50-2100MR</p>		
<p>LUMILEDS</p> <p>LED LUXEON CoB 1202/1203</p> <p>FWHM / FWTM 35.0° / 76.0°</p> <p>Efficiency 83 %</p> <p>Peak intensity 1.7 cd/lm</p> <p>LEDs/each optic 1</p> <p>Light colour White</p> <p>Required components: C13709_PF-SOCKET-VERO13-18 Bender Wirth: 438 Typ L1</p>		
<p>LUMILEDS</p> <p>LED LUXEON CoB 1202/1203</p> <p>FWHM / FWTM 37.0° / 72.0°</p> <p>Efficiency 77 %</p> <p>Peak intensity 1.5 cd/lm</p> <p>LEDs/each optic 1</p> <p>Light colour White</p> <p>Required components: C13709_PF-SOCKET-VERO13-18 C13333_MIRELLA-CL Bender Wirth: 438 Typ L1</p>		
<p>LUMILEDS</p> <p>LED LUXEON CoB 1202/1203</p> <p>FWHM / FWTM 39.0° / 79.0°</p> <p>Efficiency 86 %</p> <p>Peak intensity 1.6 cd/lm</p> <p>LEDs/each optic 1</p> <p>Light colour White</p> <p>Required components: C14037_PF-NSX-SOCKET</p>		

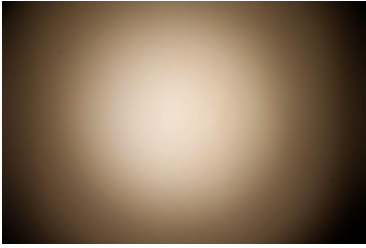
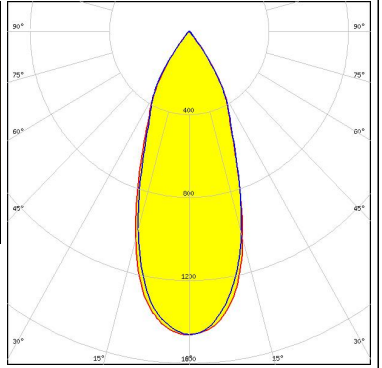
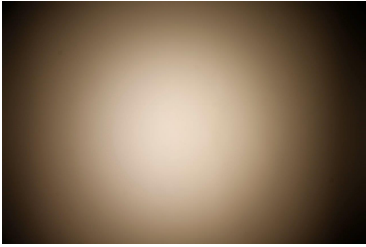
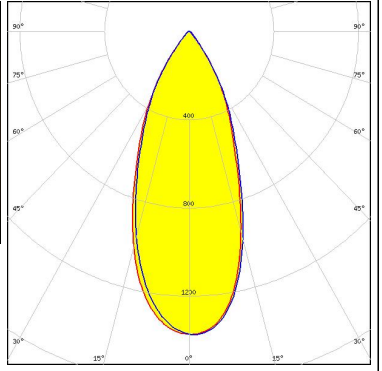
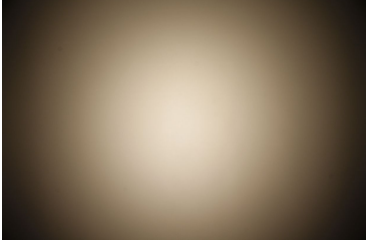
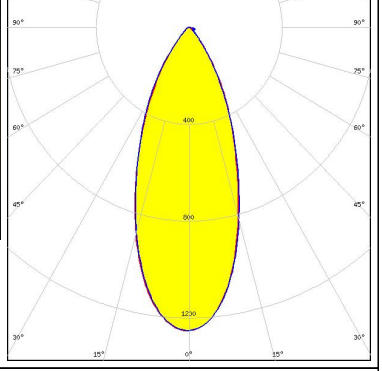
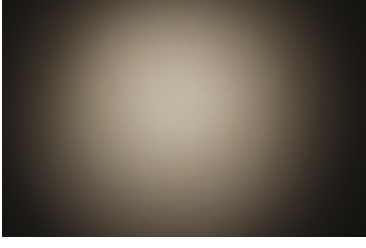
PHOTOMETRIC DATA (MEASURED):

<p>LUMILEDS</p> <p>LED LUXEON CoB 1202/1203</p> <p>FWHM / FWTM 39.0° / 74.0°</p> <p>Efficiency 80 %</p> <p>Peak intensity 1.5 cd/m</p> <p>LEDs/each optic 1</p> <p>Light colour White</p> <p>Required components: C13333_MIRELLA-CL IDEAL: 50-2100NC +50-2100MR</p>		
<p>LUMILEDS</p> <p>LED LUXEON CoB 1202/1203</p> <p>FWHM / FWTM 41.0° / 75.0°</p> <p>Efficiency 81 %</p> <p>Peak intensity 1.4 cd/m</p> <p>LEDs/each optic 1</p> <p>Light colour White</p> <p>Required components: C12479_MIRELLA-DL IDEAL: 50-2100NC +50-2100MR</p>		
<p>LUMILEDS</p> <p>LED LUXEON CoB 1202/1203</p> <p>FWHM / FWTM 40.0° / 75.0°</p> <p>Efficiency 75 %</p> <p>Peak intensity 1.3 cd/m</p> <p>LEDs/each optic 1</p> <p>Light colour White</p> <p>Required components: C13709_PF-SOCKET-VERO13-18 C12479_MIRELLA-DL Bender Wirth: 438 Typ L1</p>		
<p>LUMILEDS</p> <p>LED LUXEON CoB 1202s</p> <p>FWHM / FWTM 35.0° / 82.0°</p> <p>Efficiency 88 %</p> <p>Peak intensity 1.9 cd/m</p> <p>LEDs/each optic 1</p> <p>Light colour White</p> <p>Required components: C13761_PF-SOCKET-CXA15</p>		

PHOTOMETRIC DATA (MEASURED):

LUMILEDS

LED LUXEON CoB 1202s
 FWHM / FWTM 41.0° / 78.0°
 Efficiency 82 %
 Peak intensity 1.5 cd/lm
 LEDs/each optic 1
 Light colour White
 Required components:
 C13761_PF-SOCKET-CXA15
 C13333_MIRELLA-CL

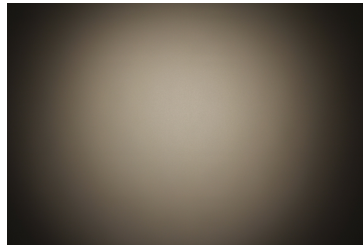

LUMILEDS

LED LUXEON CoB 1202s
 FWHM / FWTM 28.0° / 69.0°
 Efficiency 81 %
 Peak intensity 2.2 cd/lm
 LEDs/each optic 1
 Light colour White
 Required components:
 C13709_PF-SOCKET-VERO13-18
 C13333_MIRELLA-CL
 Bender Wirth: 452 Typ L1

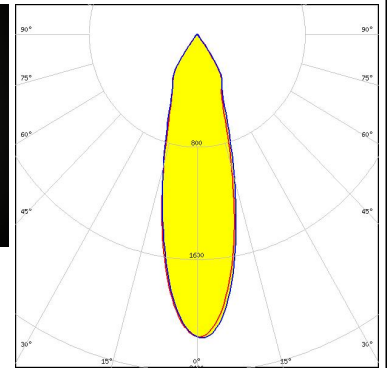
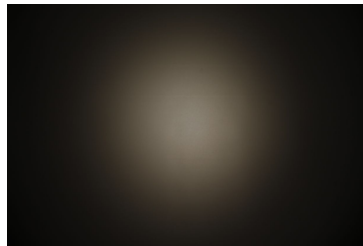

LUMILEDS

LED LUXEON CoB 1202s
 FWHM / FWTM 40.0° / 78.0°
 Efficiency 82 %
 Peak intensity 1.5 cd/lm
 LEDs/each optic 1
 Light colour White
 Required components:
 C13761_PF-SOCKET-CXA15
 C12479_MIRELLA-DL

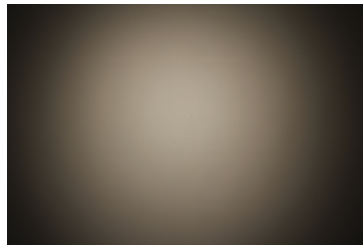

LUMILEDS

LED LUXEON CoB 1202s
 FWHM / FWTM 32.0° / 71.0°
 Efficiency 77 %
 Peak intensity 1.6 cd/lm
 LEDs/each optic 1
 Light colour White
 Required components:
 C13709_PF-SOCKET-VERO13-18
 C12479_MIRELLA-DL
 Bender Wirth: 452 Typ L1

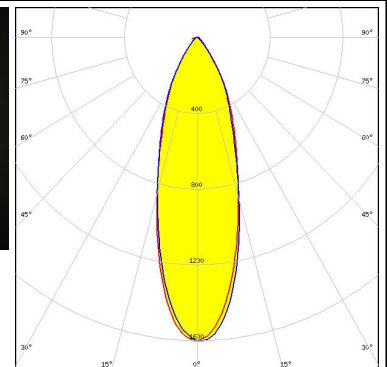
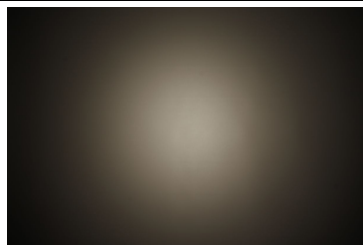

PHOTOMETRIC DATA (MEASURED):

LUMILEDS

LED LUXEON CoB 1202s
 FWHM / FWTM 25.0° / 72.0°
 Efficiency 85 %
 Peak intensity 2.6 cd/m
 LEDs/each optic 1
 Light colour White
 Required components:
 C13709_PF-SOCKET-VERO13-18
 Bender Wirth: 452 Typ L1

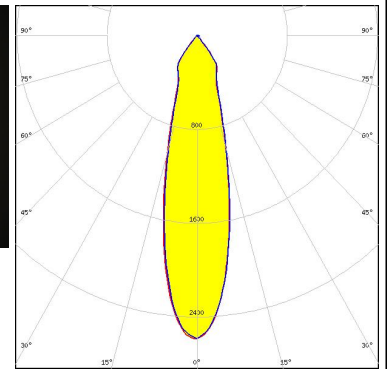

LUMILEDS

LED LUXEON Z
 FWHM / FWTM 36.0° / 75.0°
 Efficiency 79 %
 Peak intensity 1.5 cd/m
 LEDs/each optic 4
 Light colour RGBW
 Required components:
 C13083_PF-SOCKET
 C13723_MIRELLA-RZL

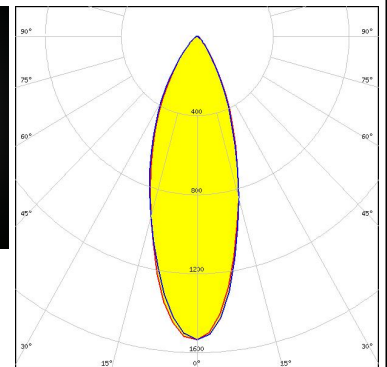
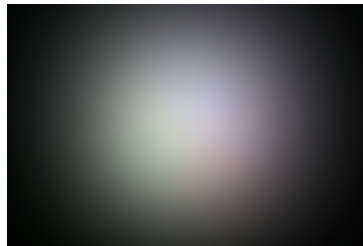

LUMINUS

LED CxM-6 (12x13)
 FWHM / FWTM 36.0° / 79.0°
 Efficiency 85 %
 Peak intensity 1.8 cd/m
 LEDs/each optic 1
 Light colour White
 Required components:
 C13083_PF-SOCKET

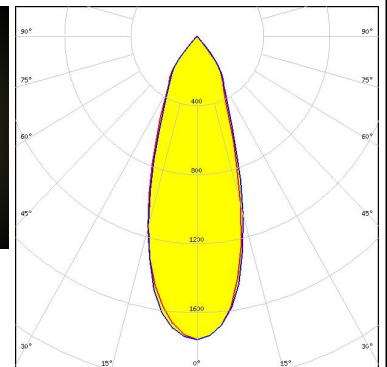
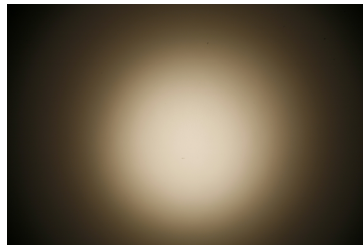

LUMINUS

LED CXM-7 (13x13)
 FWHM / FWTM 38.0° / 79.0°
 Efficiency 86 %
 Peak intensity 1.6 cd/m
 LEDs/each optic 1
 Light colour White
 Required components:
 C13083_PF-SOCKET

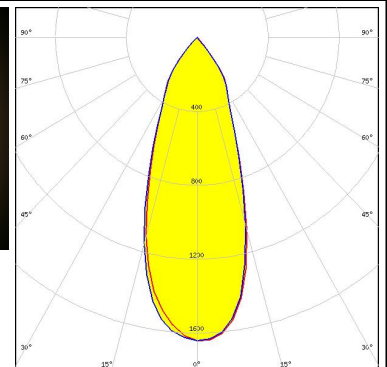
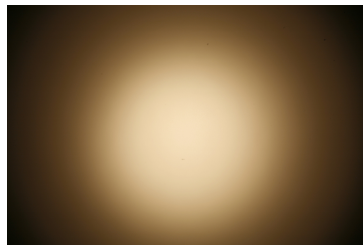

PHOTOMETRIC DATA (MEASURED):

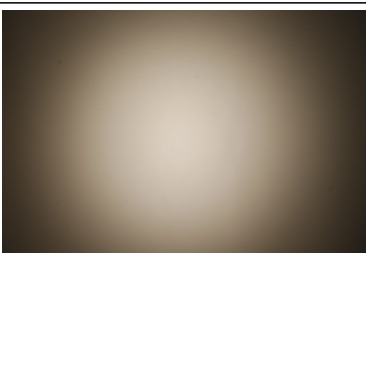
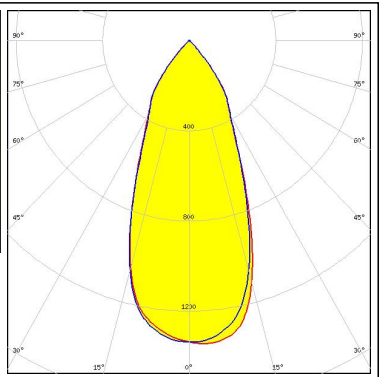
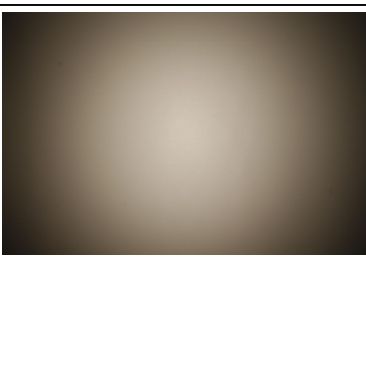
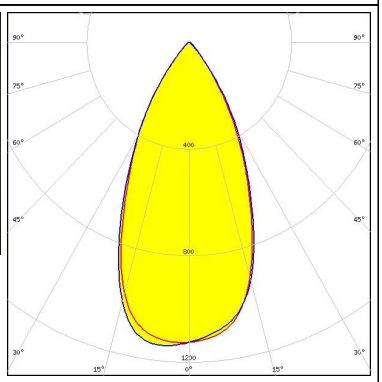
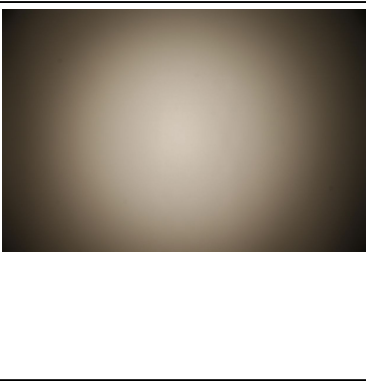
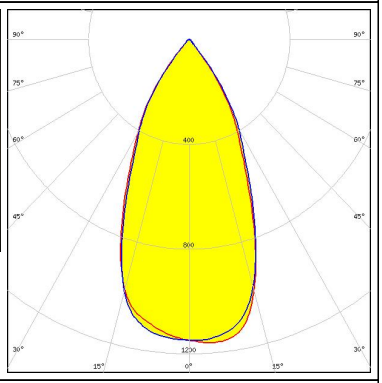
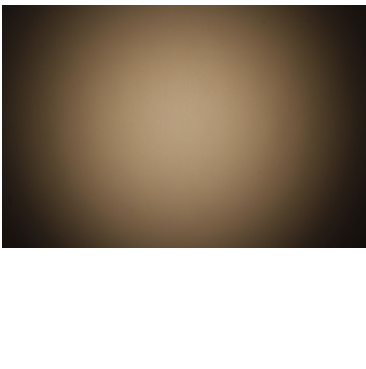
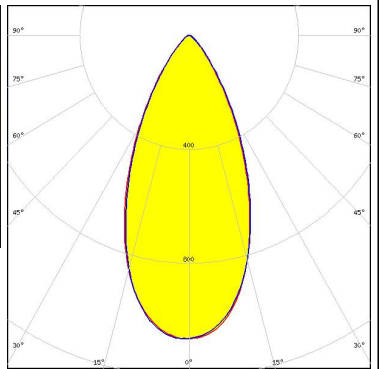
<p>LUMINUS</p> <p>LED CxM-9 (13.5x13.5) FWHM / FWTM 44.0° / 82.0° Efficiency 88 % Peak intensity 1.3 cd/lm LEDs/each optic 1 Light colour White Required components: C13083_PF-SOCKET</p>		
<p>LUMINUS</p> <p>LED CxM-9 (13.5x13.5) FWHM / FWTM 49.0° / 79.0° Efficiency 83 % Peak intensity 1.1 cd/lm LEDs/each optic 1 Light colour White Required components: C13083_PF-SOCKET C12479_MIRELLA-DL</p>		
<p>LUMINUS</p> <p>LED CxM-9 (13.5x13.5) FWHM / FWTM 48.0° / 78.0° Efficiency 83 % Peak intensity 1.2 cd/lm LEDs/each optic 1 Light colour White Required components: C13083_PF-SOCKET C13333_MIRELLA-CL</p>		
<p>LUMINUS</p> <p>LED CxM-9 (13.5x13.5) FWHM / FWTM 48.0° / 83.0° Efficiency 80 % Peak intensity 1.1 cd/lm LEDs/each optic 1 Light colour White Required components: C13083_PF-SOCKET C13723_MIRELLA-RZL</p>		

PHOTOMETRIC DATA (MEASURED):



LED COB L-Type (LES 11)
 FWHM / FWTM 45.0° / 75.0°
 Efficiency 77 %
 Peak intensity 1.2 cd/lm
 LEDs/each optic 1
 Light colour White
 Required components:
 C13709_PF-SOCKET-VERO13-18
 C13333_MIRELLA-CL
 Bender Wirth: 438 Typ L1

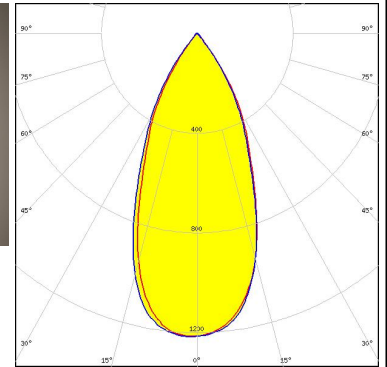
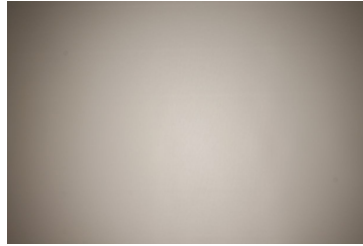

LED COB L-Type (LES 11)
 FWHM / FWTM 46.0° / 82.0°
 Efficiency 84 %
 Peak intensity 1.3 cd/lm
 LEDs/each optic 1
 Light colour White
 Required components:
 C14037_PF-NSX-SOCKET

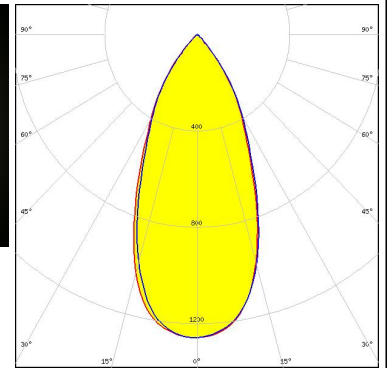
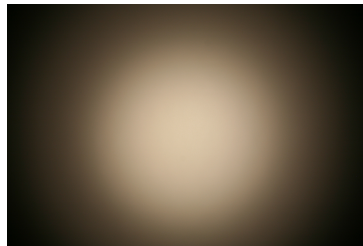



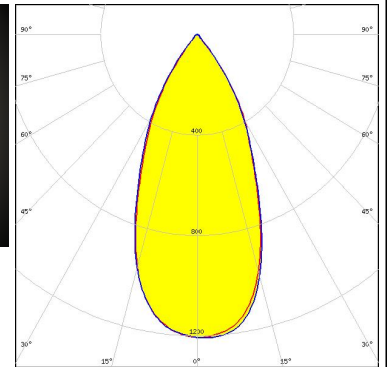
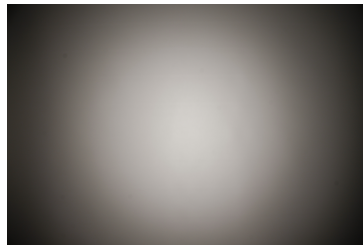

LED COB L-Type (LES 11)
 FWHM / FWTM 47.0° / 77.0°
 Efficiency 81 %
 Peak intensity 1.2 cd/lm
 LEDs/each optic 1
 Light colour White
 Required components:
 C13333_MIRELLA-CL
 IDEAL: 50-2100NC +50-2100MR

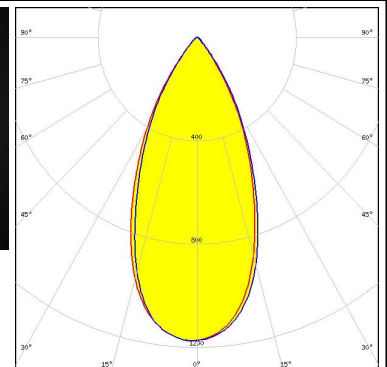
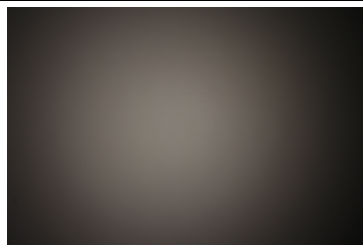



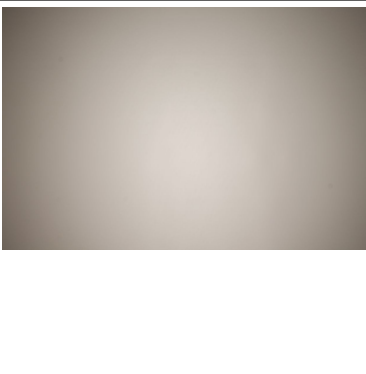
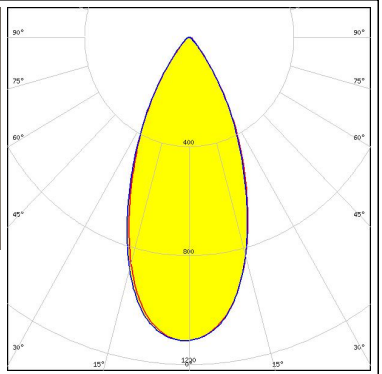

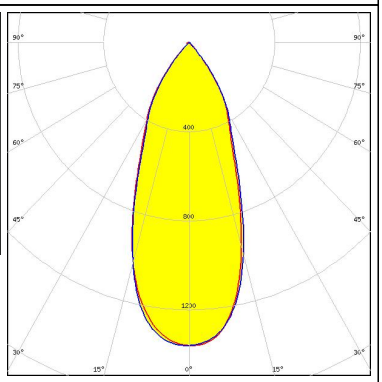

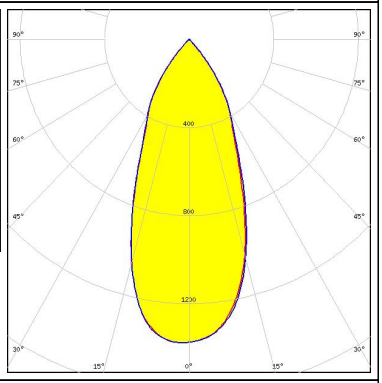
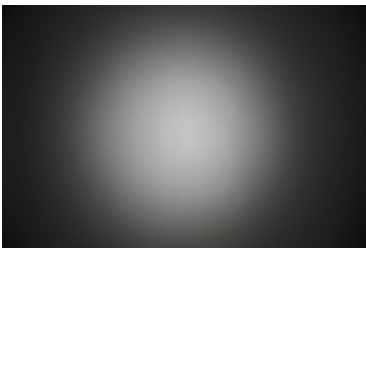
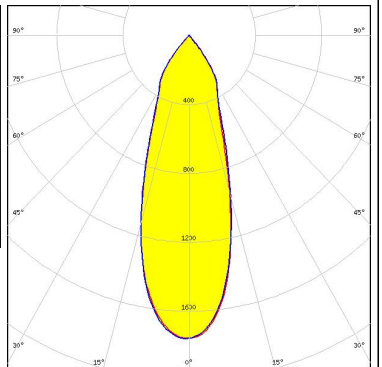
LED COB L-Type (LES 11)
 FWHM / FWTM 46.0° / 77.0°
 Efficiency 80 %
 Peak intensity 1.2 cd/lm
 LEDs/each optic 1
 Light colour White
 Required components:
 C12479_MIRELLA-DL
 IDEAL: 50-2100NC +50-2100MR



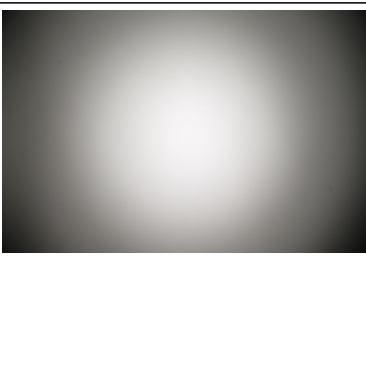
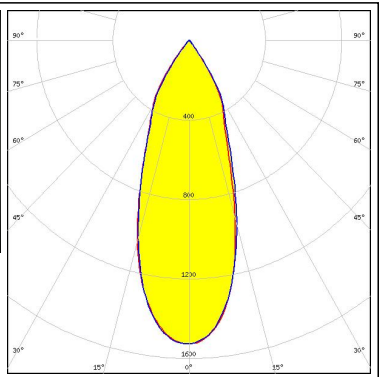

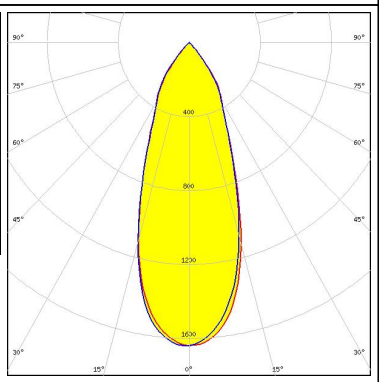
PHOTOMETRIC DATA (MEASURED):

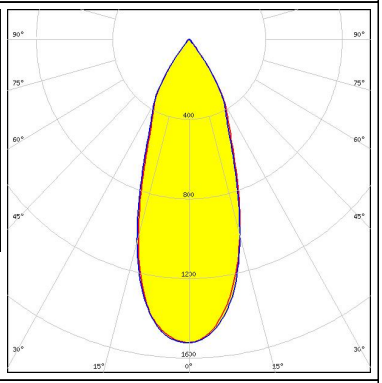
<p>NICHIA</p> <p>LED COB L-Type (LES 11)</p> <p>FWHM / FWTM 46.0° / 78.0°</p> <p>Efficiency 75 %</p> <p>Peak intensity 1.1 cd/m</p> <p>LEDs/each optic 1</p> <p>Light colour White</p> <p>Required components: C13709_PF-SOCKET-VERO13-18 C12479_MIRELLA-DL Bender Wirth: 438 Typ L1</p>		
<p>NICHIA</p> <p>LED COB L-Type (LES 11)</p> <p>FWHM / FWTM 41.0° / 79.0°</p> <p>Efficiency 81 %</p> <p>Peak intensity 1.4 cd/m</p> <p>LEDs/each optic 1</p> <p>Light colour White</p> <p>Required components: C13709_PF-SOCKET-VERO13-18 Bender Wirth: 438 Typ L1</p>		
<p>NICHIA</p> <p>LED COB L-Type (LES 11)</p> <p>FWHM / FWTM 43.0° / 80.0°</p> <p>Efficiency 86 %</p> <p>Peak intensity 1.4 cd/m</p> <p>LEDs/each optic 1</p> <p>Light colour White</p> <p>Required components: IDEAL: 50-2100NC +50-2100MR</p>		
<p>NICHIA</p> <p>LED COB L-Type (LES 9)</p> <p>FWHM / FWTM 34.0° / 76.0°</p> <p>Efficiency 84 %</p> <p>Peak intensity 1.8 cd/m</p> <p>LEDs/each optic 1</p> <p>Light colour White</p> <p>Required components: C13709_PF-SOCKET-VERO13-18 Bender Wirth: 438 Typ L1</p>		

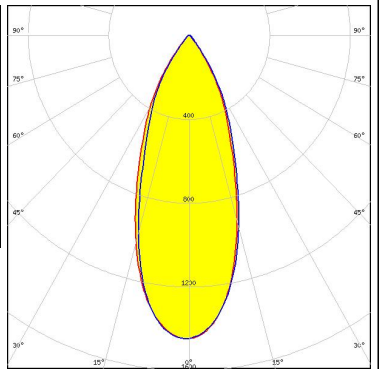

PHOTOMETRIC DATA (MEASURED):

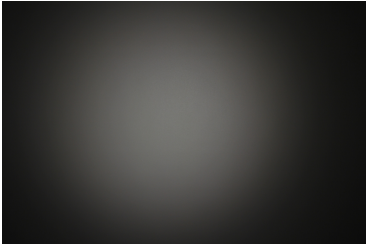
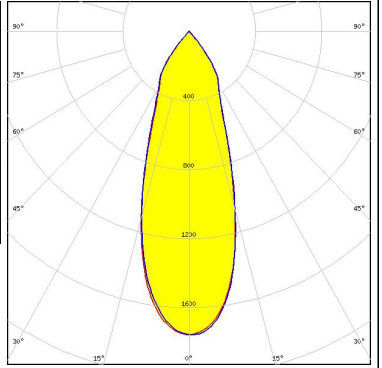
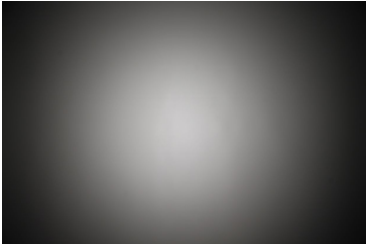
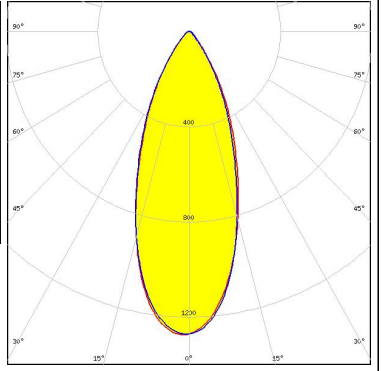
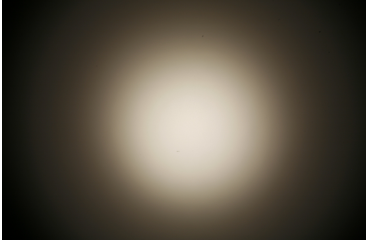
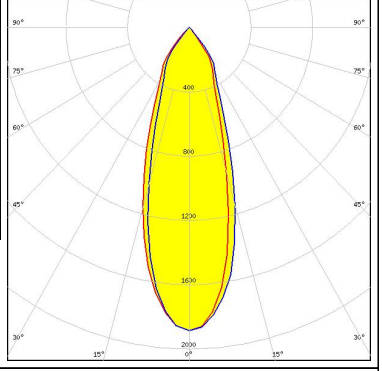
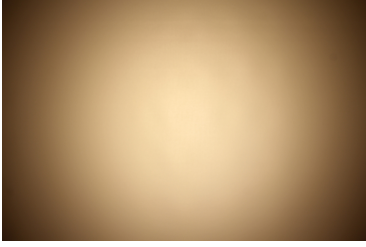
<p>NICHIA</p> <p>LED COB L-Type (LES 9)</p> <p>FWHM / FWTM 37.0° / 73.0°</p> <p>Efficiency 79 %</p> <p>Peak intensity 1.5 cd/m</p> <p>LEDs/each optic 1</p> <p>Light colour White</p> <p>Required components: C13709_PF-SOCKET-VERO13-18 C13333_MIRELLA-CL Bender Wirth: 438 Typ L1</p>		
<p>NICHIA</p> <p>LED COB L-Type (LES 9)</p> <p>FWHM / FWTM 38.0° / 78.0°</p> <p>Efficiency 86 %</p> <p>Peak intensity 1.6 cd/m</p> <p>LEDs/each optic 1</p> <p>Light colour White</p> <p>Required components: C14037_PF-NSX-SOCKET</p>		
<p>NICHIA</p> <p>LED COB L-Type (LES 9)</p> <p>FWHM / FWTM 38.0° / 73.0°</p> <p>Efficiency 81 %</p> <p>Peak intensity 1.5 cd/m</p> <p>LEDs/each optic 1</p> <p>Light colour White</p> <p>Required components: C13333_MIRELLA-CL IDEAL: 50-2100NC +50-2100MR</p>		
<p>NICHIA</p> <p>LED COB L-Type (LES 9)</p> <p>FWHM / FWTM 39.0° / 73.0°</p> <p>Efficiency 80 %</p> <p>Peak intensity 1.4 cd/m</p> <p>LEDs/each optic 1</p> <p>Light colour White</p> <p>Required components: C12479_MIRELLA-DL IDEAL: 50-2100NC +50-2100MR</p>		





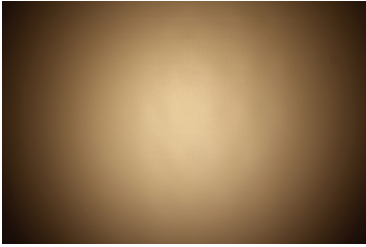

PHOTOMETRIC DATA (MEASURED):

<p>NICHIA</p> <p>LED COB L-Type (LES 9)</p> <p>FWHM / FWTM 35.0° / 77.0°</p> <p>Efficiency 87 %</p> <p>Peak intensity 1.8 cd/m</p> <p>LEDs/each optic 1</p> <p>Light colour White</p> <p>Required components: IDEAL: 50-2100NC +50-2100MR</p>		
<p>NICHIA</p> <p>LED COB L-Type (LES 9)</p> <p>FWHM / FWTM 40.0° / 75.0°</p> <p>Efficiency 76 %</p> <p>Peak intensity 1.3 cd/m</p> <p>LEDs/each optic 1</p> <p>Light colour White</p> <p>Required components: C13709_PF-SOCKET-VERO13-18 C12479_MIRELLA-DL Bender Wirth: 438 Typ L1</p>		
<p>NICHIA</p> <p>LED NSCxL036A</p> <p>FWHM / FWTM 34.0° / 76.0°</p> <p>Efficiency 85 %</p> <p>Peak intensity 1.9 cd/m</p> <p>LEDs/each optic 1</p> <p>Light colour White</p> <p>Required components: C14037_PF-NSX-SOCKET</p>		
<p>OSRAM Opto Semiconductors</p> <p>LED Duris S10</p> <p>FWHM / FWTM 45.0° / 81.0°</p> <p>Efficiency 79 %</p> <p>Peak intensity 1.3 cd/m</p> <p>LEDs/each optic 1</p> <p>Light colour White</p> <p>Required components: C13083_PF-SOCKET C12479_MIRELLA-DL</p>		

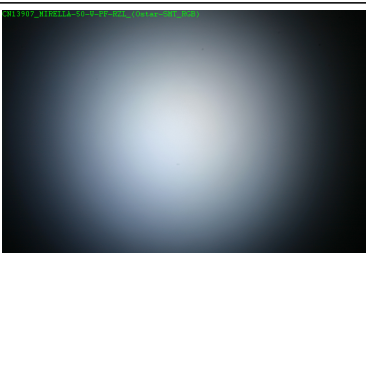
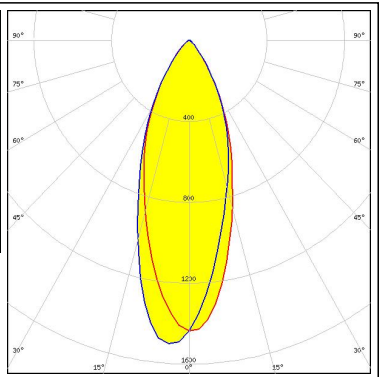
PHOTOMETRIC DATA (MEASURED):

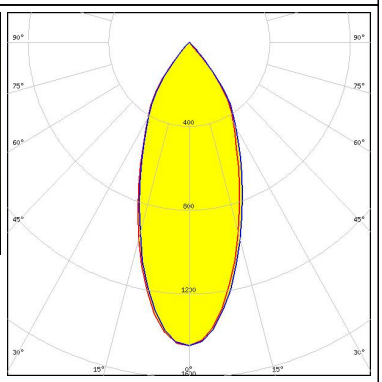
<p>OSRAM Opto Semiconductors</p> <p>LED Duris S10 FWHM / FWTM 43.0° Efficiency % LEDs/each optic 1 Light colour White</p> <p>Required components: C13083_PF-SOCKET C13333_MIRELLA-CL</p>	
<p>OSRAM Opto Semiconductors</p> <p>LED Duris S10 FWHM / FWTM 45.0° / 82.0° Efficiency 80 % Peak intensity 1.3 cd/lm LEDs/each optic 1 Light colour White</p> <p>Required components: C13083_PF-SOCKET C13723_MIRELLA-RZL</p>	
<p>OSRAM Opto Semiconductors</p> <p>LED Duris S10 FWHM / FWTM 38.0° / 82.0° Efficiency 87 % Peak intensity 1.7 cd/lm LEDs/each optic 1 Light colour White</p> <p>Required components: C13083_PF-SOCKET</p>	
<p>OSRAM Opto Semiconductors</p> <p>LED OSTAR Stage (S2WP) FWHM / FWTM 36.0° / 78.0° Efficiency 83 % Peak intensity 1.6 cd/lm LEDs/each optic 1 Light colour White</p> <p>Required components: C13083_PF-SOCKET C13723_MIRELLA-RZL</p>	

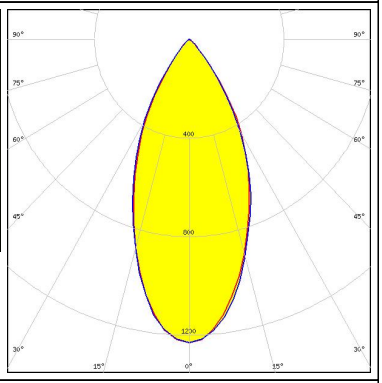
PHOTOMETRIC DATA (MEASURED):

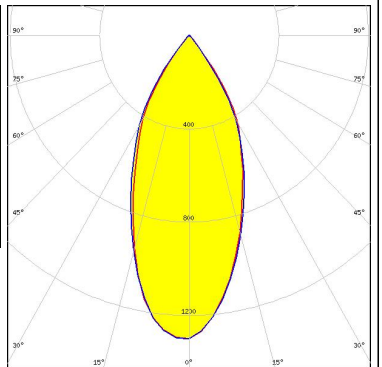
<p>OSRAM Opto Semiconductors</p> <p>LED Ostar-SMT RGB FWHM / FWTM 37.0° / 77.0° Efficiency 81 % Peak intensity 1.5 cd/lm LEDs/each optic 1 Light colour White</p> <p>Required components: C13083_PF-SOCKET C13723_MIRELLA-RZL</p>		
<p>SEOUL SEOUL SEMICONDUCTOR</p> <p>LED ZC4/6 FWHM / FWTM 42.0° / 82.0° Efficiency 86 % Peak intensity 1.4 cd/lm LEDs/each optic 1 Light colour White</p> <p>Required components: C13083_PF-SOCKET</p>		
<p>SEOUL SEOUL SEMICONDUCTOR</p> <p>LED ZC4/6 FWHM / FWTM 48.0° / 80.0° Efficiency 81 % Peak intensity 1.2 cd/lm LEDs/each optic 1 Light colour White</p> <p>Required components: C13083_PF-SOCKET C12479_MIRELLA-DL</p>		
<p>SEOUL SEOUL SEMICONDUCTOR</p> <p>LED ZC4/6 FWHM / FWTM 46.0° / 78.0° Efficiency 80 % Peak intensity 1.3 cd/lm LEDs/each optic 1 Light colour White</p> <p>Required components: C13083_PF-SOCKET C13333_MIRELLA-CL</p>		

PHOTOMETRIC DATA (MEASURED):

SHARP

LED Mini Zenigata (GW6BM)
 FWHM / FWTM 38.0° / 81.0°
 Efficiency 88 %
 Peak intensity 1.5 cd/lm
 LEDs/each optic 1
 Light colour White
 Required components:
 C13083_PF-SOCKET

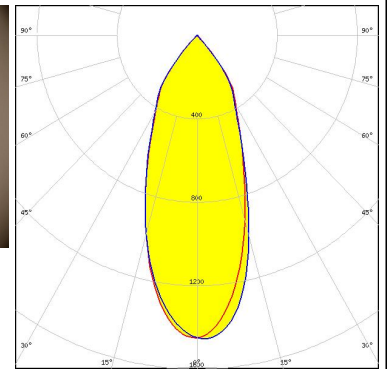
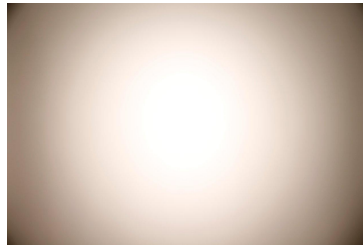

SHARP

LED Mini Zenigata (GW6BM)
 FWHM / FWTM 45.0° / 80.0°
 Efficiency 81 %
 Peak intensity 1.1 cd/lm
 LEDs/each optic 1
 Light colour White
 Required components:
 C13083_PF-SOCKET
 C12479_MIRELLA-DL

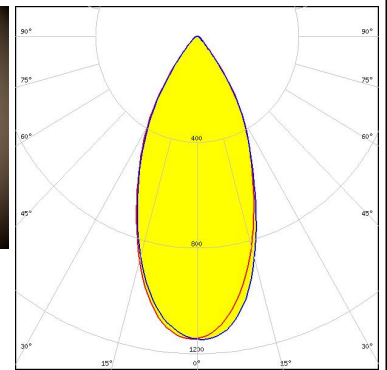
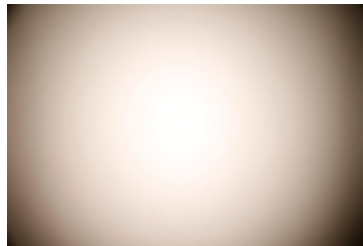

SHARP

LED Mini Zenigata (GW6BM)
 FWHM / FWTM 46.0° / 78.0°
 Efficiency 81 %
 Peak intensity 1.3 cd/lm
 LEDs/each optic 1
 Light colour White
 Required components:
 C13083_PF-SOCKET
 C13333_MIRELLA-CL

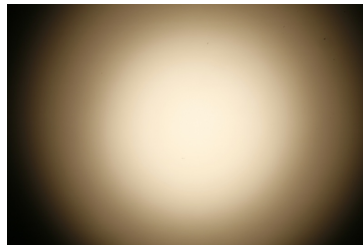

XICATO

LED XTM - 9mm LES
 FWHM / FWTM 35.0° / 76.0°
 Efficiency 83 %
 Peak intensity 1.7 cd/lm
 LEDs/each optic 1
 Light colour White
 Required components:
 C14636_XTM-PF-ADAPTER

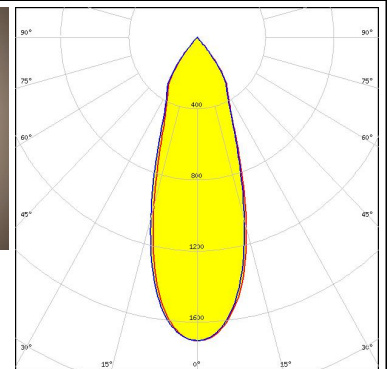
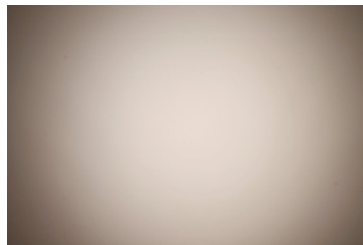

PHOTOMETRIC DATA (SIMULATED):

LUMILEDS

LED LUXEON CoB Compact
FWHM / FWTM 40.0° / 78.0°
Efficiency 82 %
Peak intensity 1.5 cd/lm
LEDs/each optic 1
Light colour White
Required components:
C13761_PF-SOCKET-CXA15
C12479_MIRELLA-DL

LUMILEDS

LED LUXEON CoB Compact
FWHM / FWTM 35.0° / 82.0°
Efficiency 88 %
Peak intensity 1.9 cd/lm
LEDs/each optic 1
Light colour White
Required components:
C13761_PF-SOCKET-CXA15

LUMILEDS

LED LUXEON CoB Compact
FWHM / FWTM 37.0° / 72.0°
Efficiency 77 %
Peak intensity 1.5 cd/lm
LEDs/each optic 1
Light colour White
Required components:
C13709_PF-SOCKET-VERO13-18
C13333_MIRELLA-CL
Bender Wirth: 452 Typ L1

LUMILEDS

LED LUXEON CoB Compact
FWHM / FWTM 25.0° / 72.0°
Efficiency 85 %
Peak intensity 2.6 cd/lm
LEDs/each optic 1
Light colour White
Required components:
C13709_PF-SOCKET-VERO13-18
Bender Wirth: 452 Typ L1

PHOTOMETRIC DATA (SIMULATED):

LUMILEDS

LED LUXEON CoB Compact
 FWHM / FWTM 32.0° / 71.0°
 Efficiency 77 %
 Peak intensity 1.6 cd/lm
 LEDs/each optic 1
 Light colour White
 Required components:
 C13709_PF-SOCKET-VERO13-18
 C12479_MIRELLA-DL
 Bender Wirth: 452 Typ L1

LUMILEDS

LED LUXEON CoB Compact
 FWHM / FWTM 41.0° / 78.0°
 Efficiency 82 %
 Peak intensity 1.5 cd/lm
 LEDs/each optic 1
 Light colour White
 Required components:
 C13761_PF-SOCKET-CXA15
 C13333_MIRELLA-CL

LUMILEDS

LED LUXEON K4
 FWHM / FWTM 54.0° / 98.0°
 Efficiency 83 %
 Peak intensity 0.9 cd/lm
 LEDs/each optic 1
 Light colour White
 Required components:
 C13761_PF-SOCKET-CXA15
 C12479_MIRELLA-DL

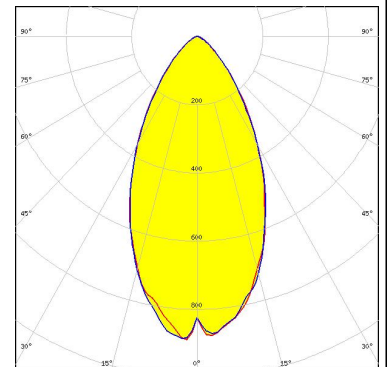

LUMILEDS

LED LUXEON K4
 FWHM / FWTM 46.0° / 84.0°
 Efficiency 88 %
 Peak intensity 1.3 cd/lm
 LEDs/each optic 1
 Light colour White
 Required components:
 C13761_PF-SOCKET-CXA15

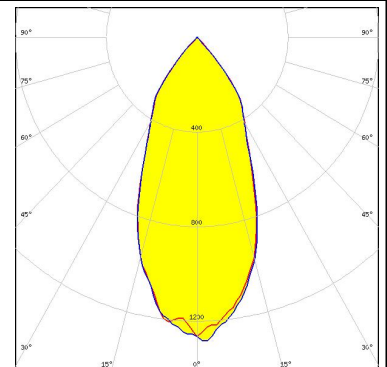

PHOTOMETRIC DATA (SIMULATED):



LED CxM-14 (19x19)
FWHM / FWTM 49.0° / 72.0°
Efficiency 75 %
Peak intensity 1 cd/lm
LEDs/each optic 1
Light colour White
Required components:
C13709_PF-SOCKET-VERO13-18
Bender Wirth: 433 Typ L1



LED CxM-14 (19x19)
FWHM / FWTM 51.0° / 81.0°
Efficiency 70 %
Peak intensity 0.9 cd/lm
LEDs/each optic 1
Light colour White
Required components:
C13709_PF-SOCKET-VERO13-18
C12479_MIRELLA-DL
Bender Wirth: 433 Typ L1



LED CxM-9 (13.5x13.5)
FWHM / FWTM 39.0° / 73.0°
Efficiency 78 %
Peak intensity 1.5 cd/lm
LEDs/each optic 1
Light colour White
Required components:
C13709_PF-SOCKET-VERO13-18
C13333_MIRELLA-CL
Bender Wirth: 434 Typ L1



LED CxM-9 (13.5x13.5)
FWHM / FWTM 36.0° / 77.0°
Efficiency 84 %
Peak intensity 1.7 cd/lm
LEDs/each optic 1
Light colour White
Required components:
C13709_PF-SOCKET-VERO13-18
Bender Wirth: 434 Typ L1

PHOTOMETRIC DATA (SIMULATED):



LED CxM-9 (13.5x13.5)
FWHM / FWTM 41.0° / 76.0°
Efficiency 76 %
Peak intensity 1.3 cd/lm
LEDs/each optic 1
Light colour White
Required components:
C13709_PF-SOCKET-VERO13-18
C12479_MIRELLA-DL
Bender Wirth: 434 Typ L1



LED COB S-Type (LES 7)
FWHM / FWTM 32.0° / 71.0°
Efficiency 77 %
Peak intensity 1.6 cd/lm
LEDs/each optic 1
Light colour White
Required components:
C13709_PF-SOCKET-VERO13-18
C12479_MIRELLA-DL
Bender Wirth: 452 Typ L1



LED COB S-Type (LES 7)
FWHM / FWTM 28.0° / 69.0°
Efficiency 81 %
Peak intensity 2.2 cd/lm
LEDs/each optic 1
Light colour White
Required components:
C13709_PF-SOCKET-VERO13-18
C13333_MIRELLA-CL
Bender Wirth: 452 Typ L1



LED COB S-Type (LES 7)
FWHM / FWTM 25.0° / 72.0°
Efficiency 85 %
Peak intensity 2.6 cd/lm
LEDs/each optic 1
Light colour White
Required components:
C13709_PF-SOCKET-VERO13-18
Bender Wirth: 452 Typ L1

PHOTOMETRIC DATA (SIMULATED):

<p>OSRAM Opto Semiconductors</p> <p>LED: Soleriq S15</p> <p>FWHM / FWTM: 56.0° / 86.0°</p> <p>Efficiency: 86 %</p> <p>Peak intensity: 1.1 cd/lm</p> <p>LEDs/each optic: 1</p> <p>Light colour: White</p> <p>Required components: C13709_PF-SOCKET-VERO13-18 Bender Wirth: 433 Typ L1</p>	
<p>OSRAM Opto Semiconductors</p> <p>LED: Soleriq S9</p> <p>FWHM / FWTM: 52.0° / 79.0°</p> <p>Efficiency: 85 %</p> <p>Peak intensity: 1.1 cd/lm</p> <p>LEDs/each optic: 1</p> <p>Light colour: White</p> <p>Required components: C13083_PF-SOCKET C13333_MIRELLA-CL</p>	
<p>OSRAM Opto Semiconductors</p> <p>LED: Soleriq S9</p> <p>FWHM / FWTM: 38.0° / 77.0°</p> <p>Efficiency: 88 %</p> <p>Peak intensity: 1.7 cd/lm</p> <p>LEDs/each optic: 1</p> <p>Light colour: White</p> <p>Required components: C13709_PF-SOCKET-VERO13-18</p>	
<p>OSRAM Opto Semiconductors</p> <p>LED: Soleriq S9</p> <p>FWHM / FWTM: 51.0° / 80.0°</p> <p>Efficiency: 85 %</p> <p>Peak intensity: 1.2 cd/lm</p> <p>LEDs/each optic: 1</p> <p>Light colour: White</p> <p>Required components: C13083_PF-SOCKET C12479_MIRELLA-DL</p>	

PHOTOMETRIC DATA (SIMULATED):

OSRAM

Opto Semiconductors

LED Soleriq S9
 FWHM / FWTM 46.0° / 82.0°
 Efficiency 91 %
 Peak intensity 1.4 cd/lm
 LEDs/each optic 1
 Light colour White
 Required components:
 C13083_PF-SOCKET

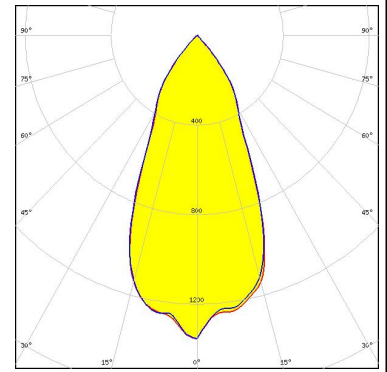

OSRAM

Opto Semiconductors

LED Soleriq S9
 FWHM / FWTM 50.0° / 80.0°
 Efficiency 85 %
 Peak intensity 1.2 cd/lm
 LEDs/each optic 1
 Light colour White
 Required components:
 C13083_PF-SOCKET
 C13723_MIRELLA-RZL

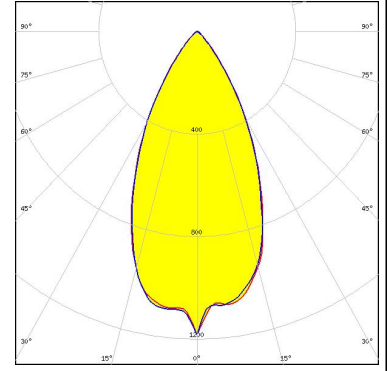

SAMSUNG

LED LC010C
 FWHM / FWTM 32.0° / 74.0°
 Efficiency 87 %
 Peak intensity 2.2 cd/lm
 LEDs/each optic 1
 Light colour White
 Required components:
 C13709_PF-SOCKET-VERO13-18
 Bender Wirth: 479 Typ L1

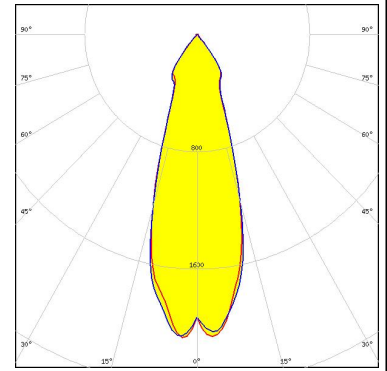

SAMSUNG

LED LC020C
 FWHM / FWTM 35.0° / 75.0°
 Efficiency 86 %
 Peak intensity 1.9 cd/lm
 LEDs/each optic 1
 Light colour White
 Required components:
 C13709_PF-SOCKET-VERO13-18
 Bender Wirth: 479 Typ L1

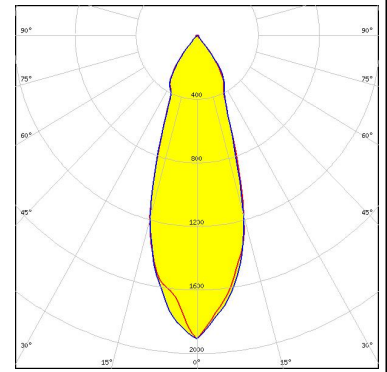

PHOTOMETRIC DATA (SIMULATED):

SAMSUNG

LED LC040C
 FWHM / FWTM 42.0° / 79.0°
 Efficiency 84 %
 Peak intensity 1.4 cd/lm
 LEDs/each optic 1
 Light colour White
 Required components:
 C13709_PF-SOCKET-VERO13-18
 Bender Wirth: 480 Typ L1

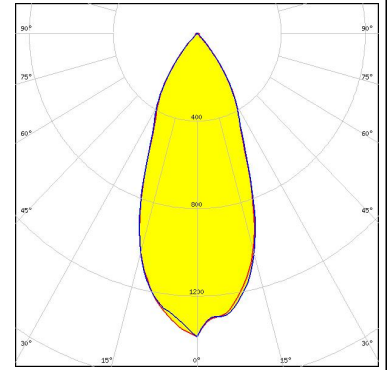

SEOUL SEMICONDUCTOR

LED ZC4/6
 FWHM / FWTM 39.0° / 73.0°
 Efficiency 78 %
 Peak intensity 1.5 cd/lm
 LEDs/each optic 1
 Light colour White
 Required components:
 C13709_PF-SOCKET-VERO13-18
 C13333_MIRELLA-CL
 Bender Wirth: 434 Typ L1



SEOUL SEMICONDUCTOR

LED ZC4/6
 FWHM / FWTM 36.0° / 77.0°
 Efficiency 84 %
 Peak intensity 1.7 cd/lm
 LEDs/each optic 1
 Light colour White
 Required components:
 C13709_PF-SOCKET-VERO13-18
 Bender Wirth: 434 Typ L1



SEOUL SEMICONDUCTOR

LED ZC4/6
 FWHM / FWTM 41.0° / 76.0°
 Efficiency 76 %
 Peak intensity 1.3 cd/lm
 LEDs/each optic 1
 Light colour White
 Required components:
 C13709_PF-SOCKET-VERO13-18
 C12479_MIRELLA-DL
 Bender Wirth: 434 Typ L1

GENERAL INFORMATION:

NOTE: The typical beam angle will be changed by different color, chip size and chip position tolerance. The typical total beam angle is the full angle measured where the luminous intensity is half of the peak value.

Due to use of high power COB's with this product, special attention to proper thermal design is highly recommended. LEDiL has no liability for direct, indirect or consecutive damages arising from the LEDiL products being used outside of the recommended temperature range.

MATERIALS:

As part of our continuous research and improvement processes, and to ensure the best possible quality and availability of our products, LEDiL reserves the right to change material grades without notice.

PRODUCT DATA USER AGREEMENT AND DISCLAIMER:

The measured data in the provided downloadable LEDiL Product Datasheets and Mechanical 2D-Drawings is rounded and provided as reference for planning. LEDiL Oy's optical specifications have been verified by conducting performance testing of the products in accordance with the company's quality system. The reported data are averaged results of multiple measurements with typical variation. LEDiL Oy reserves the right to without prior notification make changes and improvements to its products.

LEDiL Oy assumes neither warranty, nor guarantee nor any other liability of any kind for the contents and correctness of the provided data. The provided data has been generated with highest diligence but the provided data may in reality not represent the complete possible variation range of all intrinsic parameters. Therefore, in certain cases a deviation from the provided data could occur.

LEDiL Oy reserves the right to undertake technical changes of its products without further notification which could lead to changes in the provided data. LEDiL Oy assumes no liability of any kind for the possible deviation from any provided data or any other damage resulting from the usage of the provided data.

The user agrees to this disclaimer and user agreement with the download or usage of the provided files.

LEDiL Oy

Joensuunkatu 13
FI-24240 SALO
Finland

LEDiL Inc.

228 West Page Street
Suite D
Sycamore IL 60178
USA

Ledil Optics Technology (Shenzhen) Co., Ltd.

405 , Block B
Casic Motor Building
Shenzhen 518057
P.R.CHINA

Local sales and technical support

[www.ledil.com/
where_to_buy](http://www.ledil.com/where_to_buy)

Shipping locations

Salo, Finland
Hong Kong, China

Distribution Partners

[www.ledil.com/
where_to_buy](http://www.ledil.com/where_to_buy)