

Optical Terminators

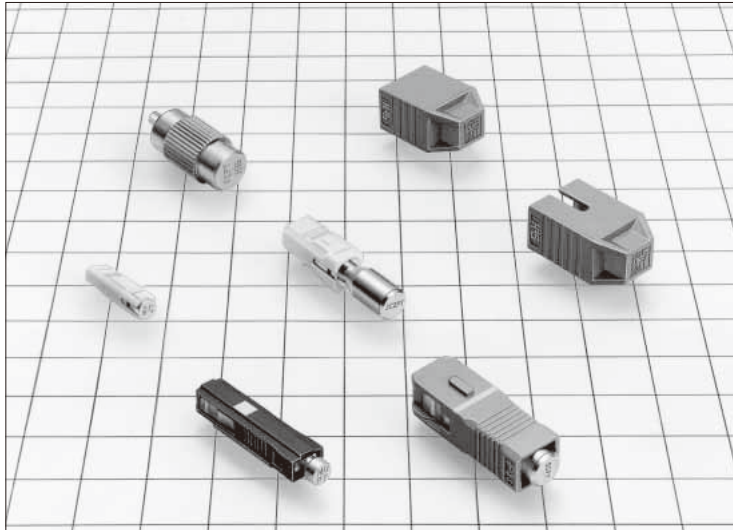

■ Features

1. Wide varieties of HRS terminators.
2. Excellent operational qualities.
3. Dual wavelength : 1310nm and 1550nm for MU terminators.
4. Please contact us if you have any requests. Hirose will offer excellent solutions to meet your requirements.

■ Applications

Termination of open ends in optical fiber communication networks.

■ Product Specifications

Ratings	Operating temperature range	-25°C to +70°C	Storage temperature range	-25°C to +85°C
	Max. Input Power	FC, SC (Plug) : 30mW SC (Receptacle) : 10mW MU (Plug) : 250mW	Fiber type	SM-9.5/125

Item		Test Method	Specifications
Optical Characteristics	Return Loss (AdPC polishing)	FC	45dB min.
		SC	
		MU	40dB min.
Mechanical Characteristics	Durability (cycles, mating/unmating)	500 times	1) Meets Return Loss requirements. 2) No breakage, crack or Looseness on components.
	Vibration	Sweep range : 10 to 55Hz, duration : 3h in each 3 mutually perpendicular direction	
	Shock	Acceleration : 981m/s ² : number of shock : 3 times in each 3 mutually perpendicular direction, total 18 times.	
Environmental Characteristics	Composite temperature - humidity cyclic test	Humidity: 90% to 96% Temperature: -10°C to +65°C Duration: 10 cycles (240h)	
	Change of Temperature	Temperature: -25°C to +70°C, Time : 400 hours (100 cycles)	
	Dry Heat	Temp: 85°C Duration: 500h	
	Cold	Temp: -25°C Duration: 500h	
	Salt Mist	Concentration: 5% Duration: 48h	No corrosion.

■ Materials

●HRFC Plug type

Part	Material
Coupling	Copper alloy
Body	Stainless steel
Ferrule	Zirconia

●HSC Receptacle type

Part	Material
Body	Synthetic resin

●HSC Plug type

Part	Material
Body	Synthetic resin
Ferrule	Zirconia

●HMU Plug type

Part	Material
Body	Synthetic resin
Ferrule	Zirconia

■ Plug type

● SC

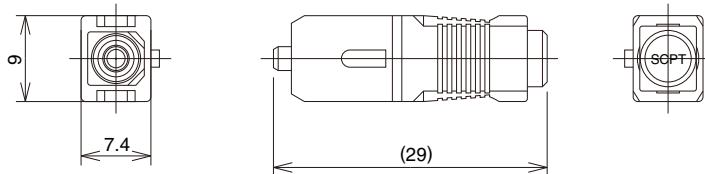

Part Number	CL No.	Return loss	Max. Input Power
HSC-TM-P1 (40)	821-0005-0-40	≥40dB	30mW

● SC - Tool Insertion/Removal

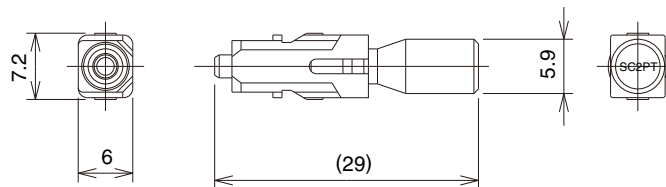

Part Number	CL No.	Return loss	Max. Input Power
HSC2-TM-P1 (40)	821-0004-8-40	≥40dB	30mW

● MU

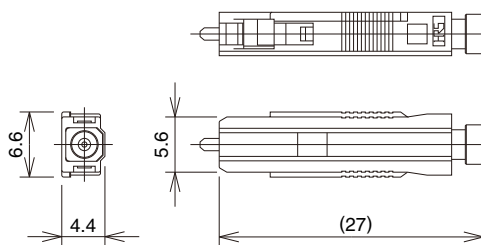
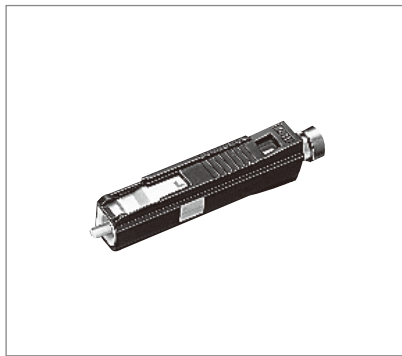

Part Number	CL No.	Return loss	Max. Input Power
HMUA-TM-P2 (60)	821-0009-1-60	≥40dB	250mW

● MU - Tool Insertion/Removal

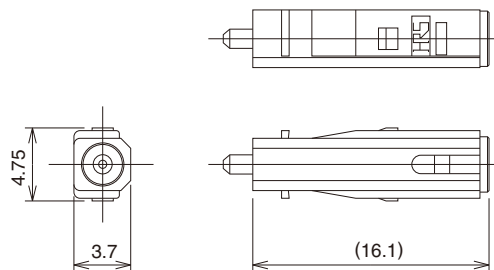

Part Number	CL No.	Return loss	Max. Input Power
HMUAJ-TM-P2 (60)	821-0010-0-60	≥40dB	250mW

●FC

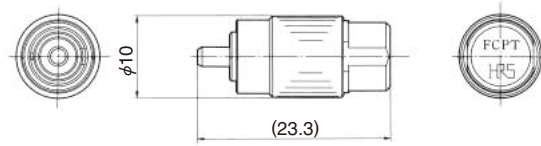

Part Number	CL No.	Return loss	Max. Input Power
HRFC-TM-P1 (60)	821-0006-3-60	≥45dB	30mW

■Receptacle type

●SC manual coupling / decoupling type

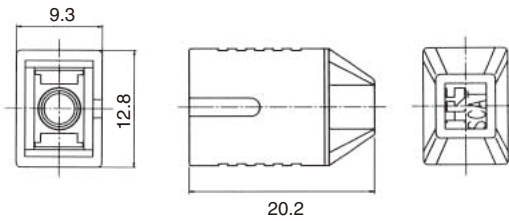

Part Number	CL No.	Return loss	Max. Input Power
HSC-TM-R1 (40)	821-0001-0-40	≥40dB	10mW

●SC tool decoupling type

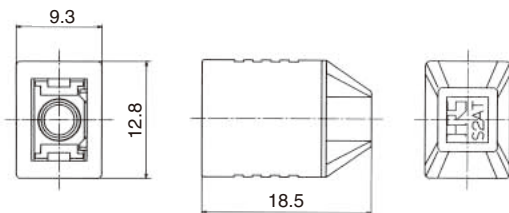

Part Number	CL No.	Return loss	Max. Input Power
HSC2-TM-R1 (40)	821-0003-5-40	≥40dB	10mW

Sep.1.2018 Copyright 2018 HIROSE ELECTRIC CO., LTD. All Rights Reserved.

SC

FC

MU

Harsh Environment

Attenuators

Terminators

POF / PCF