

			3	2	1
			KIT P/N	SLEEVE MAT.	ADAPTER COLOR
			106004-3265	PHOSPHOR BRONZE	METAL
			106004-3266	ZIRCONIA	

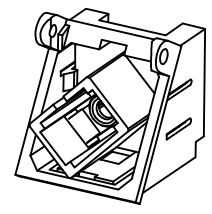

DOOR REMOVED

ADAPTER KEY LOCATION
SEE NOTE 2

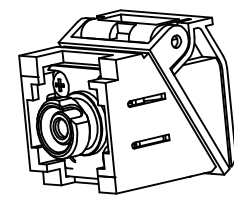
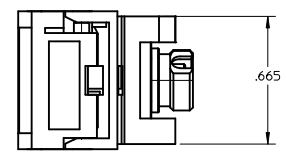
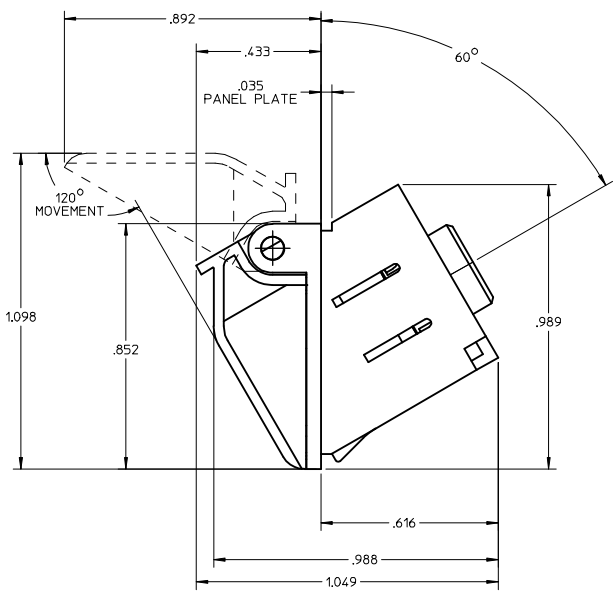
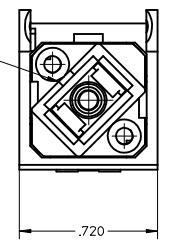

DOOR REMOVED

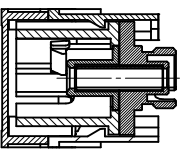
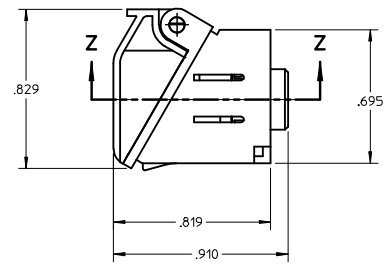

SECTION Z-Z

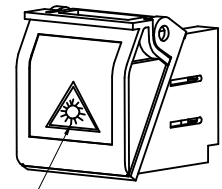
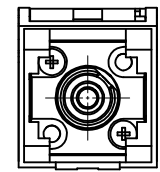

LABEL
SEE NOTE 2

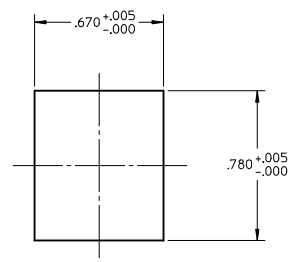

RECOMMENDED MOUNTING HOLE IN THE PANEL PLATE

NOTES:

- 1.ALL DIMENSION ARE FOR REFERENCE ONLY.
- 2.LABEL TO BE INSTALLED BY CUSTOMER.

ENTER DESCRIPTION EC NO: MF2009-0192 2008/10/30 DRWN: SZEWCZYK 2008/10/30 CHKD: 2008/10/30 APPR: IGJMIN 2008/10/30 REV: B1	QUALITY SYMBOLS ▽=0 ▽=0	GENERAL TOLERANCES (UNLESS SPECIFIED) <table border="1"> <tr> <td></td> <td>mm</td> <td>INCH</td> </tr> <tr> <td>4 PLACES</td> <td>± .005</td> <td>± .0005</td> </tr> <tr> <td>3 PLACES</td> <td>± .005</td> <td>± .0005</td> </tr> <tr> <td>2 PLACES</td> <td>± .005</td> <td>± .0005</td> </tr> <tr> <td>1 PLACE</td> <td>± .005</td> <td>± .0005</td> </tr> </table>		mm	INCH	4 PLACES	± .005	± .0005	3 PLACES	± .005	± .0005	2 PLACES	± .005	± .0005	1 PLACE	± .005	± .0005	DIMENSION STYLE INCH ONLY DRAWN BY PGIBLIN DATE 2005/11/08 CHECKED BY DATE APPROVED BY DATE	SCALE 2:1 DESIGN UNITS INCH THIRD ANGLE PROJECTION	TITLE FC/SC SPX BEZEL ADAPT KIT W/PUSH TAB, BLACK
		mm	INCH																	
	4 PLACES	± .005	± .0005																	
	3 PLACES	± .005	± .0005																	
2 PLACES	± .005	± .0005																		
1 PLACE	± .005	± .0005																		
DRAFT WHERE APPLICABLE MUST REMAIN WITHIN DIMENSIONS		MATERIAL NO. SEE TABLE SIZE C	APPROVED BY DATE	MOLEX INCORPORATED	SHEET NO. 1 OF 1															
		THIS DRAWING CONTAINS INFORMATION THAT IS PROPRIETARY TO MOLEX INCORPORATED AND SHOULD NOT BE USED WITHOUT WRITTEN PERMISSION		DOCUMENT NO. SD-106004-326X																

			3	2	1
			KIT P/N	SLEEVE MAT.	ADAPTER COLOR
			106004-3265	PHOSPHOR BRONZE	METAL
			106004-3266	ZIRCONIA	

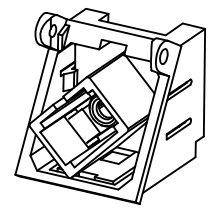
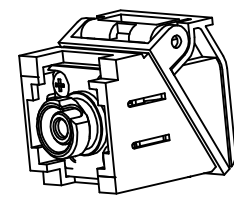
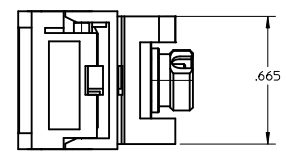
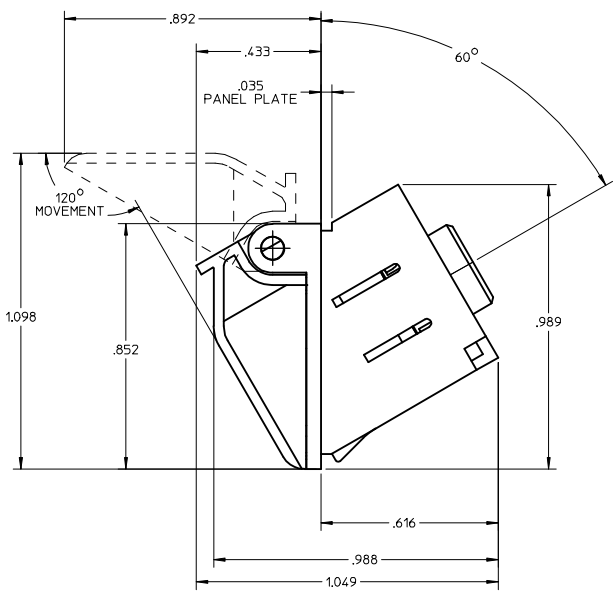

DOOR REMOVED

ADAPTER KEY LOCATION SEE NOTE 2

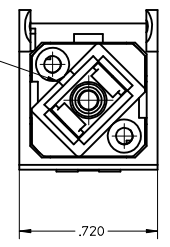

DOOR REMOVED

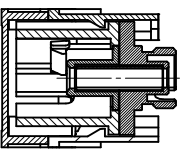
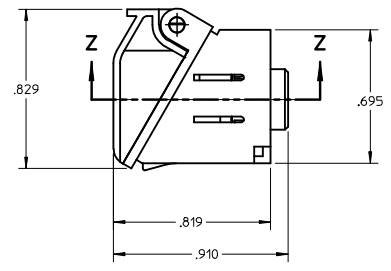

SECTION Z-Z

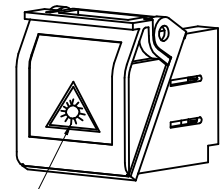
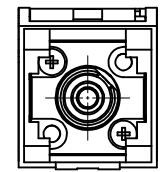

LABEL SEE NOTE 2

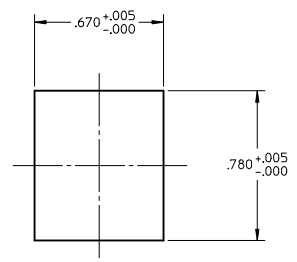

RECOMMENDED MOUNTING HOLE IN THE PANEL PLATE

NOTES:

- 1.ALL DIMENSION ARE FOR REFERENCE ONLY.
- 2.LABEL TO BE INSTALLED BY CUSTOMER.

ENTER DESCRIPTION EC NO: MF2009-0192 2008/10/30 DRWN: SZEWCZYK 2008/10/30 CHKD: 2008/10/30 APPR: IGJMIN 2008/10/30	QUALITY SYMBOLS ▽=0 ▽=0	GENERAL TOLERANCES (UNLESS SPECIFIED)		DIMENSION STYLE INCH ONLY	SCALE 2:1	DESIGN UNITS INCH	THIRD ANGLE PROJECTION		
		4 PLACES ± --- ± ---	DRAWN BY PGIBLIN	DATE 2005/11/08	TITLE FC/SC SPX BEZEL ADAPT KIT W/PUSH TAB, BLACK				
		3 PLACES ± --- ± ---	CHECKED BY	DATE	MOLEX INCORPORATED				
		2 PLACES ± --- ± ---	APPROVED BY		DATE	MATERIAL NO. SEE TABLE	DOCUMENT NO. SD-106004-326X	SHEET NO. 1 OF 1	
1 PLACE ± --- ± ---	ANGULAR ±1/2°		DRAFT WHERE APPLICABLE MUST REMAIN WITHIN DIMENSIONS						
B1	REV	THIS DRAWING CONTAINS INFORMATION THAT IS PROPRIETARY TO MOLEX INCORPORATED AND SHOULD NOT BE USED WITHOUT WRITTEN PERMISSION							