

# 3M™ MetPak™ HSHM Press-Fit Header

2 mm Type CR, 55 Signal Contacts, 5 Rows, Straight

HSHM Series

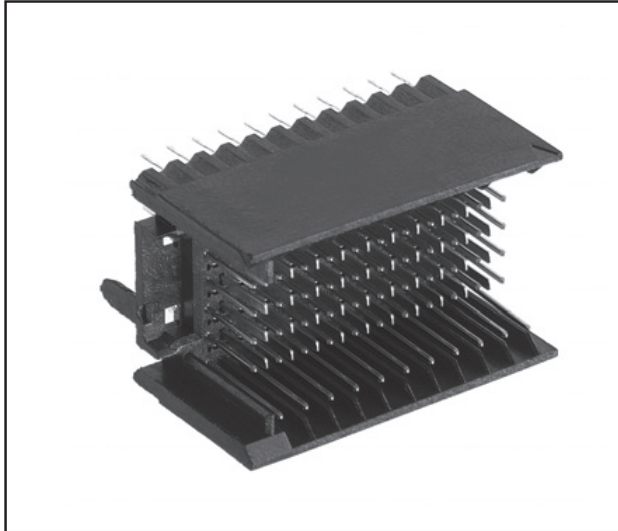

- Up to 5 Gb/s data rates
- Low crosstalk at high frequencies
- 50/100  $\Omega$  (single-ended /differential) impedance
- Modular/scalable format IEC 61076-4-101
- 63 mated lines per linear inch
- End-to-end stackable with 5 row 3M™ MetPak™ CP2, HM and HSHM sockets
- See the Regulatory Information Appendix (RIA) in the “RoHS compliance” section of [www.3mconnector.com](http://www.3mconnector.com) for compliance information

Date Modified: November 9, 2010

TS-2065-B  
Sheet 1 of 3

## Physical

**Insulation Material:** High Temperature Thermoplastic (LCP)

Flammability: UL 94V-0

### Contact

Material: Copper Alloy

Plating: See Ordering Information

## Performance

### Mechanical:

Normal Force (Nominal): 0.57 N [58 g] Signal, 0.74 N [75 g] Shield

Engagement Force (Nominal): 0.32 N [33 g] Signal, 0.22 N [22 g] Shield

Separation Force (Nominal): 0.20 N [20 g] Signal, 0.20 N [20 g] Shield

Wipe (Nominal, Shortest Contact): 2.67 mm [0.105 in] Signal, 1.57 mm [0.062 in] Shield

Mate/Unmate Cycles: 250

Application: This module is not suitable for stand-alone use. (Refer to IEC-61076-4-101)

### Electrical:

Data Rate: 5 Gb/s

Characteristic Impedance: 50  $\Omega$  Single-ended, 100  $\Omega$  Differential

Current Rating (Fully Loaded): 1 A @ 70°C Signal

Insulation Resistance:  $10^4$  M $\Omega$  @ 100 V<sub>DC</sub>

Withstanding Voltage: 750 V<sub>rms</sub>

## Environmental

**Temperature Rating:** -55° C to 125° C

UL File No.: E68080

MetPak is a trademark of 3M Company.

# 3M™ MetPak™ HSHM Press-Fit Header

2 mm Type CR, 55 Signal Contacts, 5 Rows, Straight

HSHM Series

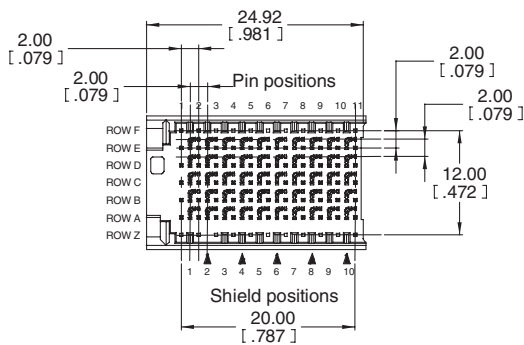

mm (Inch)

Tolerance Unless Noted		
	0	0.0
	±3	±0.3
		±0.13

[ ] Dimensions for Reference Only

▲ denotes shield column (tail only) omitted for the row differential pair part

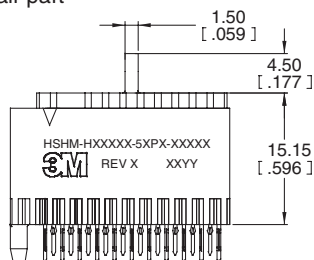

Coaxial, column differential and stripline configuration shown with protective caps\*

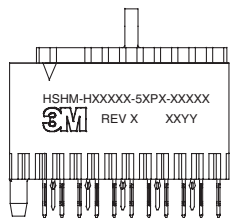

Row differential configuration shown with protective caps\*

\* Caps to be removed after press-fit installation process

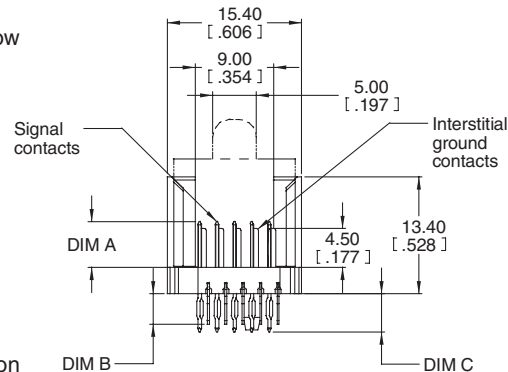

DIM A = Pin mating length  
DIM B = Shield tail length  
DIM C = Pin tail length

Standard Configuration  
DIM A = 5.3 mm for rows A through E  
For non-standard configurations, contact sales representative

## Ordering Information

**HSHM-H055CRX - 5CPX-XXXXX** (rows F and Z not loaded)

High Speed Option:

- 4 = Coaxial, column differential and stripline (75 Ω) applications
- 5 = Row differential applications

Tail Length:

- 1 = 4.4 mm pin and 3.5 mm shield
- 2 = 2 mm pin and 2 mm shield

Plating μm [μ"]:

- TG30 = 0.76 [30] Min. Au Contact Area  
2.54 [100] Min. SnPb Terminal Area (RIA C2 & E2 apply)  
1.27 [50] Min. Ni All over  
Standard Option
- TG30L = 0.76 [30] Min. Au Contact Area, Lubricated  
2.54 [100] Min. SnPb Terminal Area (RIA C2 & E2 apply)  
1.27 [50] Min. Ni All over  
Typically higher make order quantities as compared to TG30.
- TG50 = 1.27 [50] Min. Au Contact Area, Lubricated  
2.54 [100] Min. SnPb Terminal Area (RIA C2 & E2 apply)  
1.27 [50] Min. Ni All over  
Non-Standard Option (Available with longer lead times and higher make order quantities, MOQ)

TS-2065-B  
Sheet 2 of 3

# 3M™ MetPak™ HSHM Press-Fit Header

2 mm Type CR, 55 Signal Contacts, 5 Rows, Straight

HSHM Series

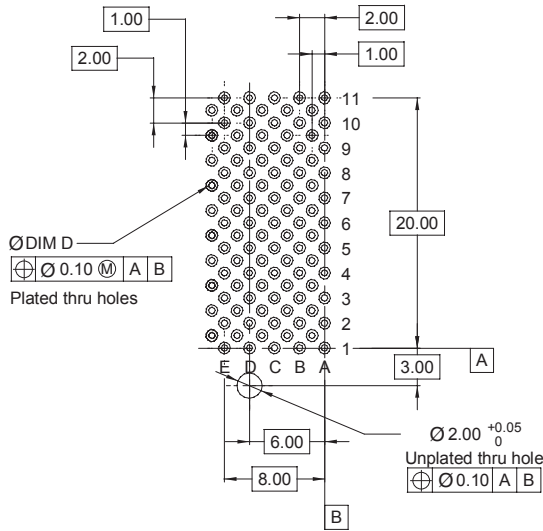

Recommended PCB hole mounting pattern for coaxial, column differential and stripline applications

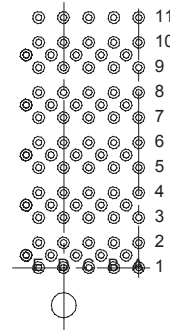

Recommended PCB hole mounting pattern for row differential applications

Same geometry as left view without the ground vias

Hole Plating Table mm [in.]			
Finished Hole Dia. "D"	Cu. Thickness	SnPb Thickness	Drilled Hole Dia.
0.457 - 0.559 [.0180 - .0220]	0.025 - 0.045 [.0010 - .0018]	0.008 - 0.018 [.0003 - .0007]	0.584 - 0.625 [.0230 - .0246]

TS-2065-B  
Sheet 3 of 3

**Important Notice**

All statements, technical information, and recommendations related to 3M's products are based on information believed to be reliable, but the accuracy or completeness is not guaranteed. Before using this product, you must evaluate it and determine if it is suitable for your intended application. You assume all risks and liability associated with such use. Any statements related to the product which are not contained in 3M's current publications, or any contrary statements contained on your purchase order shall have no force or effect unless expressly agreed upon, in writing, by an authorized officer of 3M.

**Warranty; Limited Remedy; Limited Liability.**

This product will be free from defects in material and manufacture for a period of one (1) year from the time of purchase. **3M MAKES NO OTHER WARRANTIES INCLUDING, BUT NOT LIMITED TO, ANY IMPLIED WARRANTY OF MERCHANTABILITY OR FITNESS FOR A PARTICULAR PURPOSE.** If this product is defective within the warranty period stated above, your exclusive remedy shall be, at 3M's option, to replace or repair the 3M product or refund the purchase price of the 3M product. **Except where prohibited by law, 3M will not be liable for any indirect, special, incidental or consequential loss or damage arising from this 3M product, regardless of the legal theory asserted.**

**3M Electronics Solutions Division**

6801 River Place Blvd.  
Austin, TX 78726-9000  
U.S.A.  
1-800-225-5373  
[www.3Mconnector.com](http://www.3Mconnector.com)

Please recycle. Printed in USA.  
© 3M 2010. All rights reserved.  
RIA-2217B-E

3M is a trademark of 3M Company.