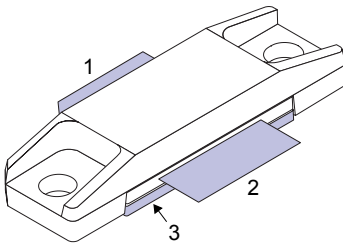

LDMOS avionics radar transistor

STAC780-2B
Features

Order code	Frequency	V _{DD}	P _{OUT}	Gain	Efficiency
STAC1011-350	1030 to 1090 MHz	36 V	350 W	15 dB	53 %

- Excellent thermal stability
- Common source configuration
- P_{OUT} = 350W with 15 dB gain over 1030 to 1090 MHz
- ST air-cavity STAC packaging technology

Applications

- Avionics

Description

The STAC1011-350 is a common source N-channel enhancement-mode lateral field-effect RF power transistor designed for avionics applications at frequencies range 1030 to 1090 MHz.

Pin connection	
Pin	Connection
1	Drain
2	Gate
3	Source (bottom side)



Product status link
STAC1011-350

Product summary	
Order code	STAC1011-350
Marking	1011-350
Package	STAC780-2B
Packing	Tube
Base/bulk quantity	15/90

1 Electrical data

1.1 Maximum ratings

Table 1. Absolute maximum ratings (T_{CASE} = +25 °C)

Symbol	Parameter	Value	Unit
V _{(BR)DSS}	Drain-source voltage	80	V
V _{GS}	Gate-source voltage	±20	V
P _{DISS}	Power dissipation (at T _{CASE} = +70 °C)	1440	W
T _J	Maximum operating junction temperature	+200	°C
T _{STG}	Storage temperature range	-65 to +150	°C

1.2 Thermal data

Table 2. Thermal data

Symbol	Parameter	Value	Unit
R _{thj-case}	Junction-case thermal resistance	0.09	°C/W

Note: Thermal data at 50 μs - 2%

1.3 ESD protection characteristics

Table 3. ESD protection

Symbol	Test methodology	Class
HBM	Human body model (per JESD22-A114)	2

2 Electrical characteristics

($T_C = 25\text{ }^\circ\text{C}$ unless otherwise specified)

2.1 Static

Table 4. Static

Symbol	Parameter	Test conditions	Min.	Typ.	Max.	Unit
$V_{(BR)DSS}$	Drain-source breakdown voltage	$V_{GS} = 0\text{ V}, I_{DS} = 20\text{ mA}$	80			V
I_{DSS}	Zero gate voltage drain leakage current	$V_{GS} = 0\text{ V}, V_{DS} = 28\text{ V}$			2	μA
I_{GSS}	Gate-source leakage current	$V_{GS} = 15\text{ V}, V_{DS} = 0\text{ V}$			1	μA
$V_{GS(Q)}$	Gate quiescent voltage	$V_{DS} = 28\text{ V}, I_{DS} = 150\text{ mA}$	2.0		5.0	V
$V_{DS(on)}$	Drain-source on voltage	$V_{GS} = 10\text{ V}, I_{DS} = 6\text{ A}$		550	600	mV
G_{FS}	Forward transconductance	$V_{DS} = 10\text{ V}, I_{DS} = 6\text{ A}$	2.5			S

2.2 Dynamic

Table 5. Dynamic

Symbol	Parameter	Test conditions	Min.	Typ.	Max.	Unit
f	Frequency		1030		1090	MHz
P_{OUT}	Output power	$P_{IN} = 15\text{ W}$	350	370		W
G_{PS}	Power gain	$P_{OUT} = 350\text{ W}$	13	15		dB
η_D	Drain efficiency	$P_{OUT} = 350\text{ W}$	50	53		%
t_r	Rise time	$P_{OUT} = 350\text{ W}$			50	ns
t_f	Fall time	$P_{OUT} = 350\text{ W}$			25	ns
ΔG_{PS}	Gain variation	$P_{OUT} = 350\text{ W}$, gain droop within the pulse			0.2	dB
VSWR	Load mismatch	All phase angles at $P_{OUT} = 350\text{ W}$			10:1	

Note: $V_{DD} = 36\text{ V}, I_{DQ} = 150\text{ mA}$, pulse width = 50 μs , duty cycle = 2%.

3 Impedance data

Figure 1. Impedance data

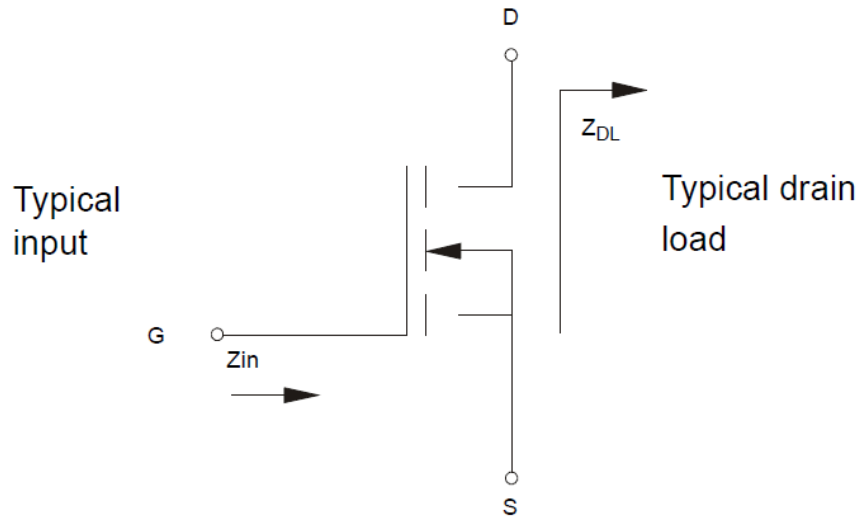
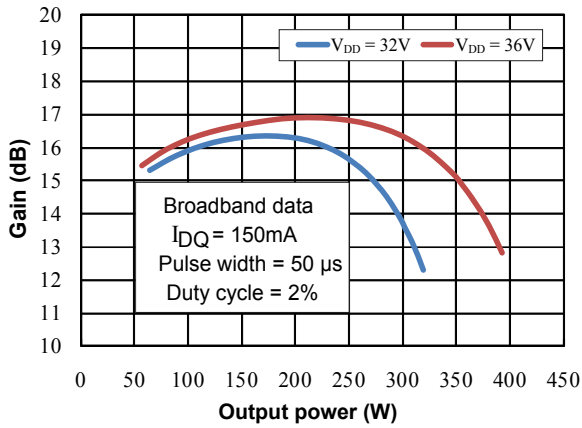

Table 6. Impedance data

Frequency (MHz)	Z_{source} (Ohm)	Z_{load} (Ohm)
1030	$1+j0.126$	$1.12+j0.242$
1060	$0.855+j0.417$	$0.929+j0.560$
1090	$0.709+j0.764$	$0.752+j0.881$

4 Typical performances

Figure 2. Output power vs gain and supply voltage at 1030 MHz



AM10111V1

Figure 3. Output power and efficiency vs frequency - broadband data

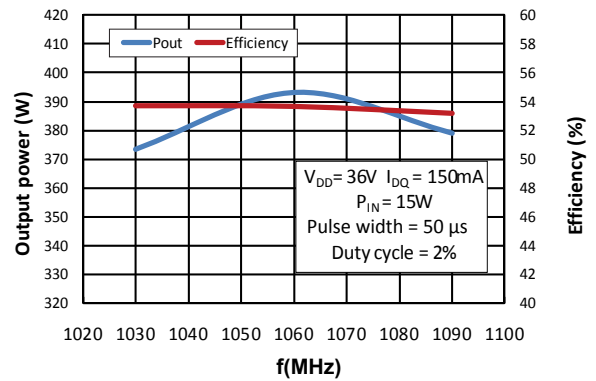

AM10112V1

Figure 4. Output power vs gain and supply voltage at 1060 MHz

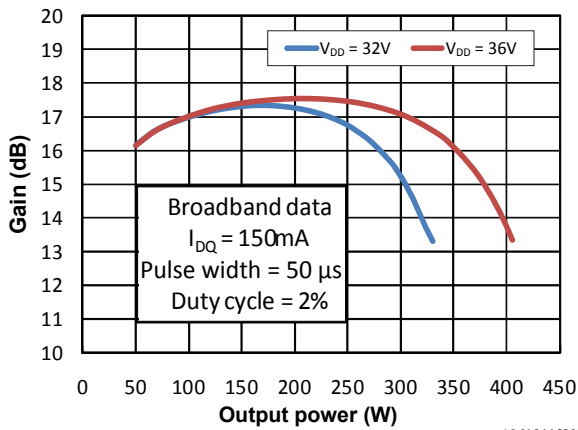

AM10113V1

Figure 5. Gain and input return loss vs frequency - broadband data

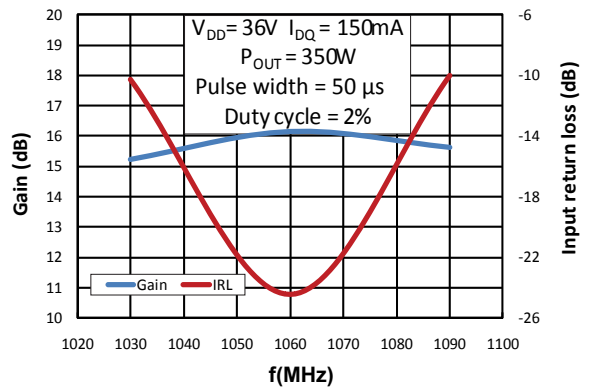

AM10114V1

Figure 6. Output power vs gain and supply voltage at 1090 MHz

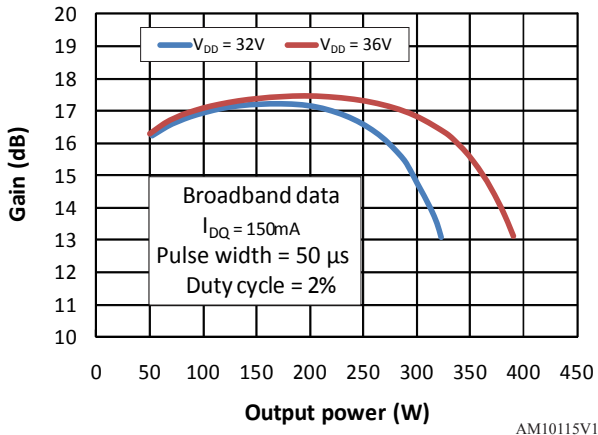

Figure 7. Output power vs input power - broadband data

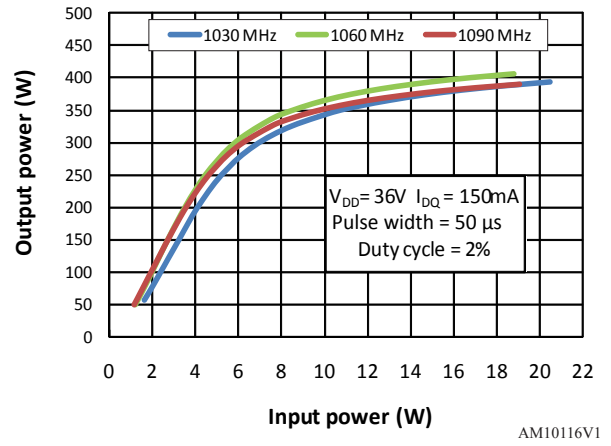
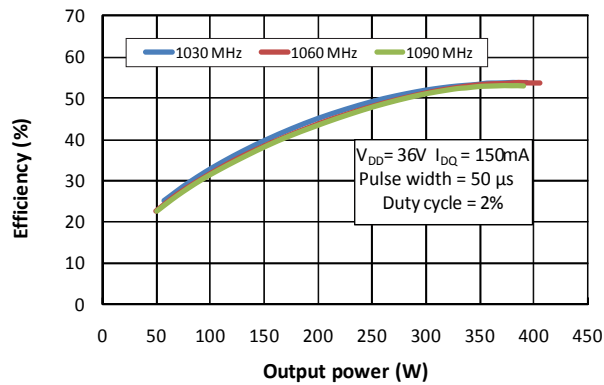

Figure 8. Efficiency vs output power broadband data



5 Test circuit

5.1 Electrical schematic and BOM

Figure 9. Broadband 1030-1090 MHz electrical schematic

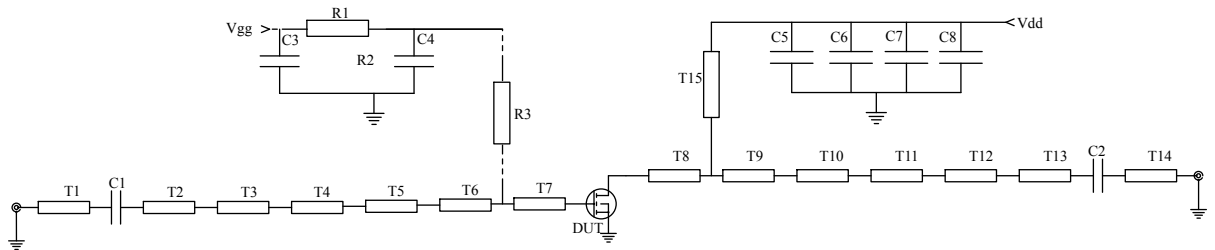

GADG060420201202SA

Table 7. Component list

Component	Description	Dimension (X,Y)	Values
TL1	Stripline	L=0.111" W=0.022"	
TL2	Stripline	L=0.063" W=0.196"	
TL3	Stripline	L=0.172" W=0.082"	
TL4	Stripline	L=0.273" W=0.022"	
TL5	Stripline	L=1.196" W=0.196"	
TL6	Stripline	L=0.092" W=0.929"	
TL7	Stripline	L=0.311" W=1.259"	
TL8	Stripline	L=0.100" W=0.994"	
TL9	Stripline	L=0.148" W=0.994"	
TL10	Stripline	L=0.385" W=0.929"	
TL11	Stripline	L=1.183" W=0.196"	
TL12	Stripline	L=0.111" W=0.022"	
TL13	Stripline	L=0.183" W=0.196"	
TL14	Stripline	L=0.145" W=0.022"	
TL15	Stripline	L=0.741" W=0.022"	
S1	Shim	L=0.022" W=0.389"	
S2	Shim	L=0.050" W=0.087"	
S3	Shim	L=0.050" W=0.087"	
S4	Shim	L=0.100" W=0.0474"	
S5	Shim	L=0.110" W=0.160"	
S6	Shim	L=0.110" W=0.160"	
S7	Shim	L=0.050" W=0.183"	
S8	Shim	L=0.055" W=0.366"	
S9	Shim	L=0.050" W=0.183"	
S10	Shim	L=0.105" W=0.183"	
S11	Shim	L=0.050" W=0.183"	

Component	Description	Dimension (X,Y)	Values
S12	Shim	L=0.380" W=0.065"	
S13	Shim	L=0.105" W=0.065"	
S14	Shim	L=0.022" W=0.200"	
C8	1000 μ F, 63 V electrolytic capacitor		1000 μ F
C7	100 μ F, 100 V electrolytic capacitor		100 μ F
C6	ATC700B122JT 50 X		1200 pF
C5	ATC100B330KW500X		33 pF
C4	ATC100B101KW500X		100 pF
C3	220 μ F, 63 V electrolytic capacitor		220 pF
C2	ATC100A300JP 150X		30 pF
C1	ATC100A300JP 150X		30 pF
R3	CR1206-4W-132JB		1.3 k Ω
R2	CR1206-4W-681JB		680 Ω
R1	CR1206-4W-361JB		360 Ω
PCB	Rogers Duroid 6010 Er = 10.2, Th = 0.64 mm	3X5"	

5.2 Layout

Figure 10. Broadband 1030-1090 MHz test circuit layout

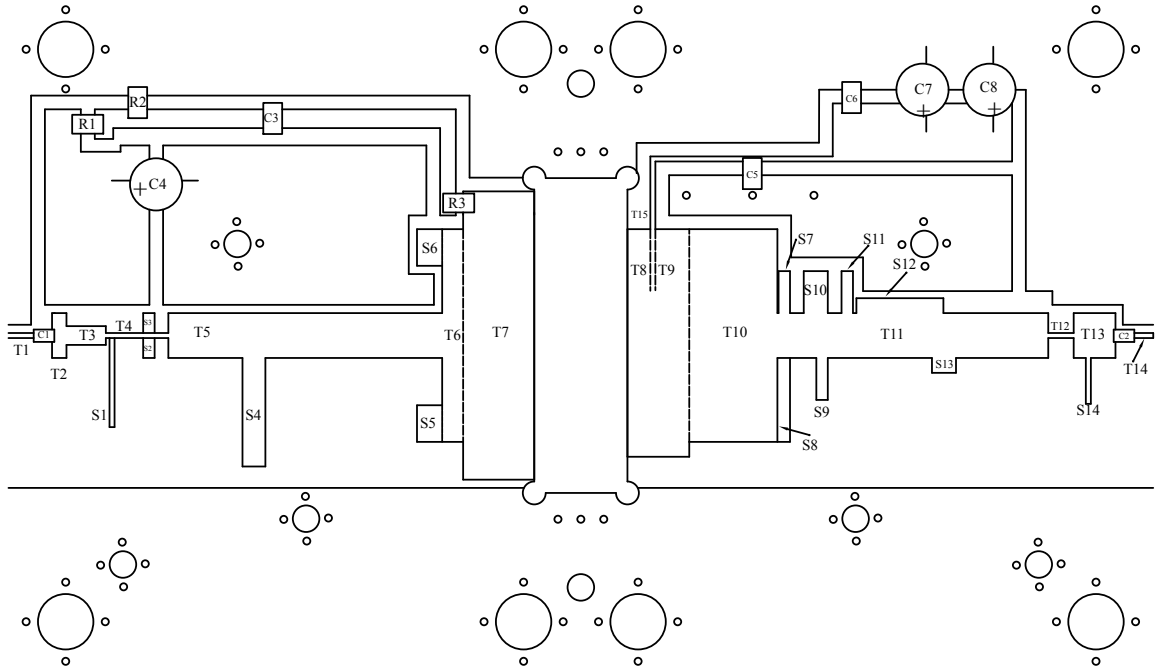

AM12368v1

Figure 11. Demonstration board picture

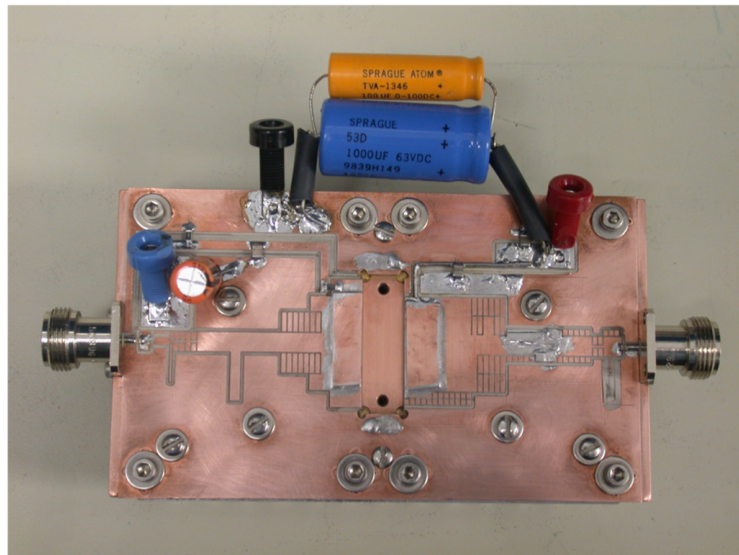

AM12369v1

6 Package information

In order to meet environmental requirements, ST offers these devices in different grades of **ECOPACK** packages, depending on their level of environmental compliance. ECOPACK specifications, grade definitions and product status are available at: www.st.com. ECOPACK is an ST trademark.

6.1 STAC780-2B package information

Figure 12. STAC780-2B package outline

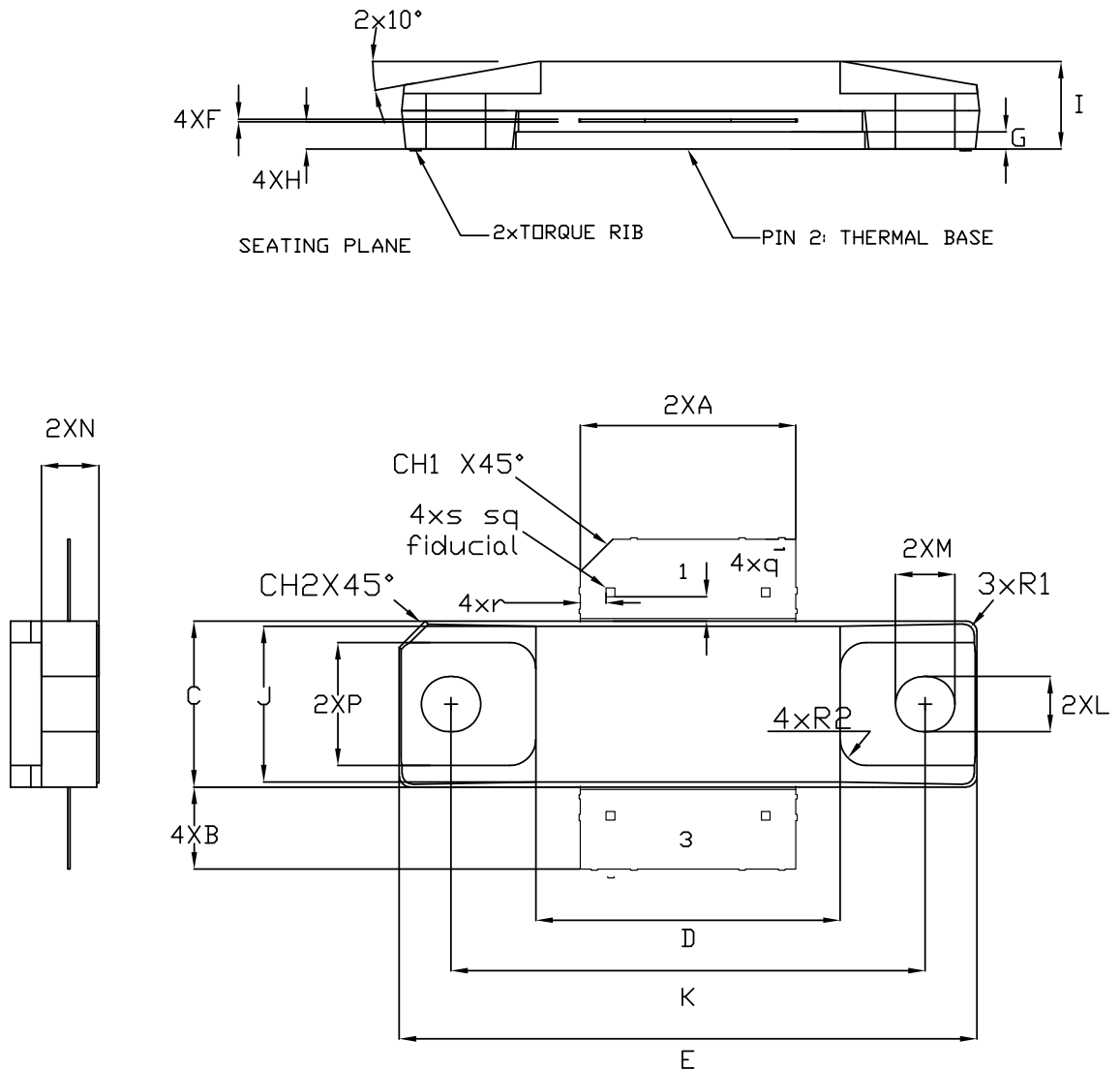

PIN	CONNECTION
1	DRAIN
2	SOURCE
3	GATE

DM00481924_2

Table 8. STAC780-2B mechanical data

Ref.	Millimeters		
	Min.	Typ.	Max.
A	12.65		12.75
B	4.57		5.08
C	9.65		9.91
D	17.78		18.08
E	33.88		34.19
F	0.11		0.17
G	0.97		1.14
H	1.52		1.70
I	4.83		5.33
J	9.52		9.78
K	27.69		28.19
L	3.20	3.25	3.30
M	3.43	3.51	3.58
N	3.30	3.38	3.45
p	7.14	7.21	7.29
q		1.37	
r		1.52	
R1		0.63	
R2		1.52	
s		0.51	
θ		10°	
CH1		2.72	
CH2		1.52	

6.2 STAC780-2B marking information

Figure 13. STAC780-2B marking information

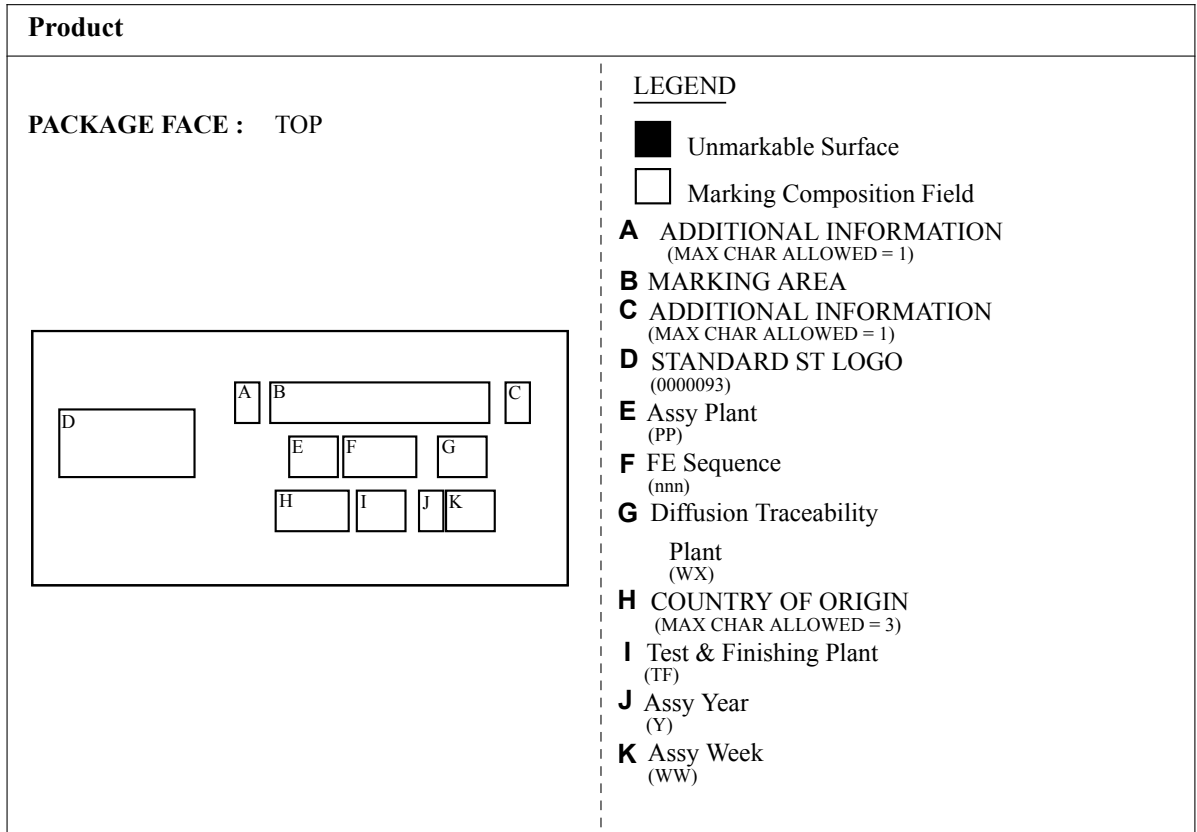

CD00362879_13

Revision history

Table 9. Document revision history

Date	Version	Changes
25-Jul-2011	1	First release
12-Sep-2011	2	Inserted <i>Section 5: Circuit and BOM</i> .
13-Sep-2011	3	Updated dimensions in <i>Table 8: STAC265B mechanical data</i> .
06-Jun-2012	4	<ul style="list-style-type: none"> – Modified: <i>Figure 10</i> – Added: <i>Figure 11</i> – Updated the entire <i>Table 7</i>
24-Sep-2012	5	<ul style="list-style-type: none"> Updated title on the cover page. Updated <i>Table 4</i>.
20-May-2014	6	<ul style="list-style-type: none"> Updated <i>Figure 12: Package dimensions</i>. Minor text changes. Document status promoted from preliminary to production data.
16-Apr-2020	7	<ul style="list-style-type: none"> Updated <i>Section 6.1 STAC780-2B package information</i>. Added <i>Section 1.3 ESD protection characteristics</i>. Minor text changes.
13-Jul-2020	8	Modified features table on cover page.

Contents

1	Electrical data	2
1.1	Maximum ratings	2
1.2	Thermal data	2
1.3	ESD protection characteristics	2
2	Electrical characteristics	3
2.1	Static	3
2.2	Dynamic	3
3	Impedance data	4
4	Typical performances	5
5	Test circuit	7
5.1	Electrical schematic and BOM	7
5.2	Layout	9
6	Package information	10
6.1	STAC780-2B package information	11
6.2	STAC780-2B marking information	13
	Revision history	14

IMPORTANT NOTICE – PLEASE READ CAREFULLY

STMicroelectronics NV and its subsidiaries (“ST”) reserve the right to make changes, corrections, enhancements, modifications, and improvements to ST products and/or to this document at any time without notice. Purchasers should obtain the latest relevant information on ST products before placing orders. ST products are sold pursuant to ST’s terms and conditions of sale in place at the time of order acknowledgement.

Purchasers are solely responsible for the choice, selection, and use of ST products and ST assumes no liability for application assistance or the design of Purchasers’ products.

No license, express or implied, to any intellectual property right is granted by ST herein.

Resale of ST products with provisions different from the information set forth herein shall void any warranty granted by ST for such product.

ST and the ST logo are trademarks of ST. For additional information about ST trademarks, please refer to www.st.com/trademarks. All other product or service names are the property of their respective owners.

Information in this document supersedes and replaces information previously supplied in any prior versions of this document.

© 2020 STMicroelectronics – All rights reserved