

THIS DOCUMENT IS SUBJECT TO CHANGE WITHOUT NOTICE. IT IS CONFIDENTIAL AND A PROPERTY OF Amphenol LTW. DISCLOSURE TO THIRD PARTY HAS TO BE AUTHORIZED BY Amphenol LTW.

REV.	ECN NO.	DATE	SIGN	DESCRIPTION
B	LEN1580037-038	2015/07/26	Yulong_wang	Change to Share Drawing.
C	LEN1690060-061	2016/09/05	Yulong_wang	Add 3, 4 Pin & IP69K.

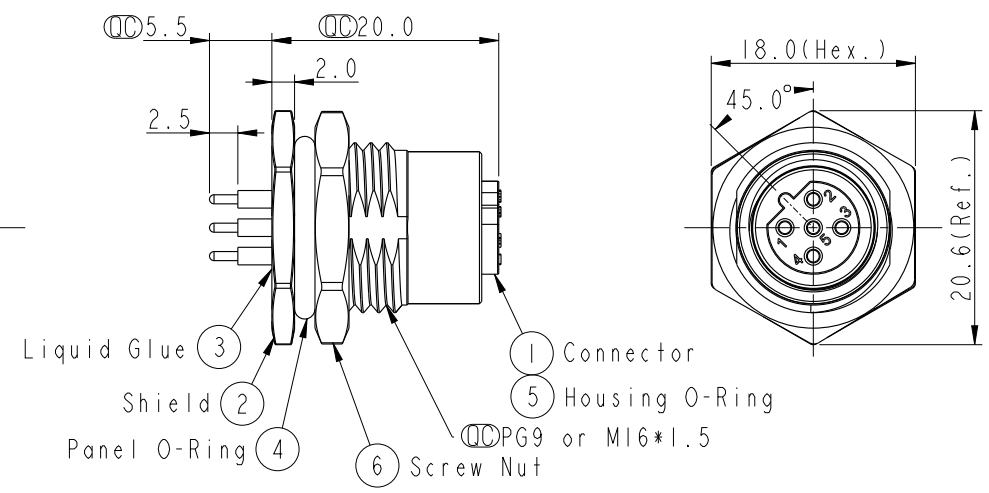

- Note:
- \*  $\varnothing$  Important Dimension.
  - \* Waterproof Rate: IP68, IP69K.
  - \* Housing: Nylon+GF, Black.
  - \* Female Pin: Copper Alloy, Gold Plated.
  - \* Shield: Zinc Alloy, Nickel Plated.
  - \* Screw Nut: Zinc Alloy, Nickel Plated.
  - \* Panel O-Ring: Viton, Black.
  - \* Housing O-Ring: Viton, Green.
  - \* Rated Voltage: 3 & 4Pin 250V dc. or ac.  
5Pin 60V dc. or ac.
  - \* Rated Current: 4A
  - \* Operating Temperature: -40~+105°C
  - \* For Panel Thickness Max 4.5mm.
  - \* Recommended Nut Torque: 4-6 Kgf.cm.

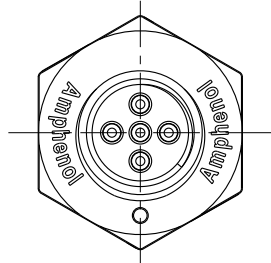
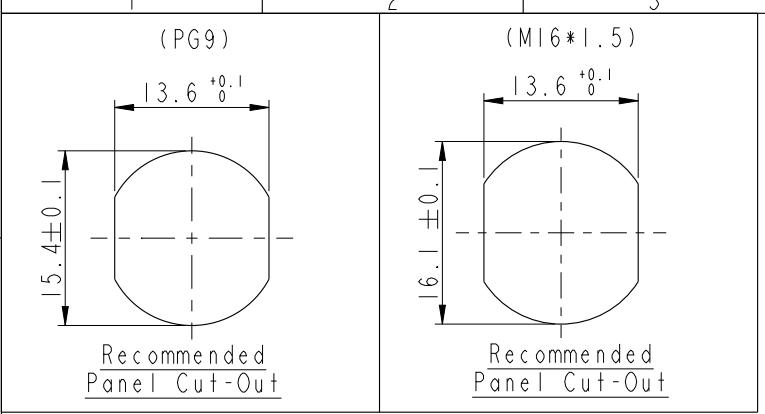
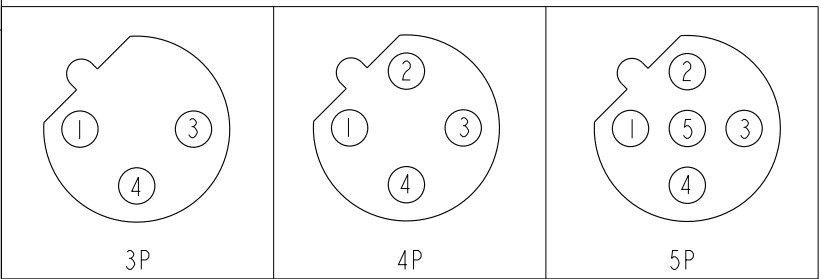
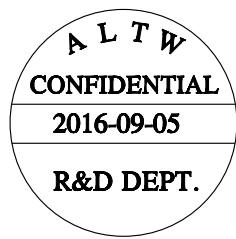

Pin Assignment Front View

UNIT: mm			TITLE M12 B-Code Female Conn. PCB Type Unshielded
TOLERANCE .X ±0.25 .XX ±0.1 .XXX ±0.05 ANGLES ±1°	SCALE 3:2	SIZE A4	SHEET 1 OF 2
REV. C	WC-REV. A.5	$\varnothing$ : Inspection item	

**Amphenol LTW**  
安費諾亮泰企業股份有限公司

ITEM NO.	DRAWN BY Yulong_wang	DATE 2016-09-05
DWG NO. M12B-XXPFFP-SF8XXX	CHECKED BY Jinhai	DATE 2016-09-05
CUSTOMER ALTW	APPROVED BY Jerry	DATE 2016-09-05

THIS DOCUMENT IS SUBJECT TO CHANGE WITHOUT NOTICE. IT IS CONFIDENTIAL AND A PROPERTY OF Amphenol LTW. DISCLOSURE TO THIRD PARTY HAS TO BE AUTHORIZED BY Amphenol LTW.

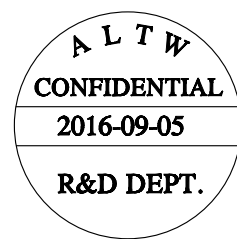

M 12B - XX P F F P - S F 8 XXX

12B: B-Code  
 03: 3Pin  
 04: 4Pin  
 05: 5Pin

P: Panel (板端)  
 F: Female Connector (母座)  
 F: Female Pin (母Pin)

001: PG9  
 002: M16\*1.5  
 8: IP68/69K (防水等級68/69K)  
 F: Front Fasten (前鎖式/Enclosure Rear Mount)  
 S: Screw (螺紋式)  
 P: PCB THT/DIP Type (180° 基板插件式)

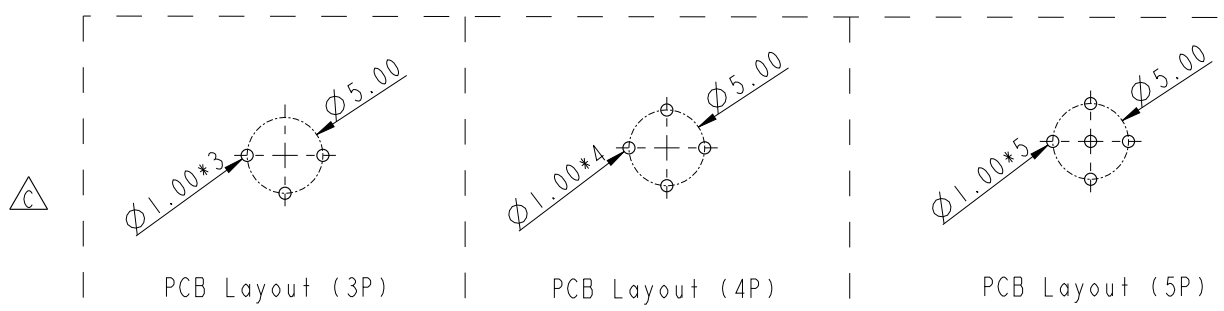

UNIT: mm		
TOLERANCE		
.X	±0.25	
.XX	±0.1	
.XXX	±0.05	
ANGLES	±1°	

TITLE M12 B-Code Female Conn. PCB Type Unshielded		
SCALE 3:2	SIZE A4	SHEET 2 OF 2
REV. C	WC-REV. A.4	: Inspection item

**Amphenol LTW**  
 安費諾亮泰企業股份有限公司

ITEM NO	DRAWN BY Yulong_wang	DATE 2016-09-05
DWG NO M12B-XXPFFP-SF8XXX	CHECKED BY Jinhai	DATE 2016-09-05
CUSTOMER ALTW	APPROVED BY Jerry	DATE 2016-09-05

DATE 2016-09-05
DATE 2016-09-05
DATE 2016-09-05