

NLAS4717

Analog Switch, High Bandwidth, Dual SPDT

The NLAS4717 is an advanced CMOS analog switch fabricated in sub-micron silicon gate CMOS technology. The device is a dual independent Single Pole Double Throw (SPDT) switch featuring two low $R_{DS(on)}$ of 4.5 Ω at 3.0 V.

The device also features guaranteed Break-Before-Make (BBM) switching, assuring the switches never short the driver.

The NLAS4717 is available in two small size packages:

- ◆ Micro10: 3.0 x 5.0 mm
- ◆ Flip-Chip-10: 2.0 x 1.5 mm

Features

- Low $R_{DS(on)}$: 4.5 Ω @ 3.0 V
- Matching Between the Switches $\pm 0.5 \Omega$
- Wide Low Voltage Range: 1.8 V to 5.5 V
- High Bandwidth > 40 MHz
- 1.65 V to 5.5 V Operating Range
- Low Threshold Voltages on Pins 4 and 8 (CTRL Pins)
- Ultra-Low Charge Injection ≤ 6.0 pC
- Low Standby Current – $I_{CC} = 1.0$ nA (Max) @ $T_A = 25^\circ\text{C}$
- OVT* on Pins 4 and 8 (CTRL Logic Pins)
- Pb-Free Packages are Available

Typical Applications

- Cell Phones
- PDAs
- MP3s
- Digital Still Cameras

Important Information

- ESD Protection:
HBM = 2000 V, MM = 200 V
- Latchup Max Rating: 200 mA (Per JEDEC EIA/JESD78)
- Pin-to-Pin Compatible with MAX4717

*OVT

- Overvoltage Tolerance (OVT) specific pins to operate higher than normal supply voltages, with no damage to the devices or to signal integrity.



ON Semiconductor®

<http://onsemi.com>

MARKING DIAGRAMS



A1
FLIP-CHIP-10
CASE 489AA

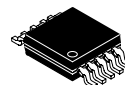
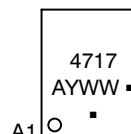

Micro10
CASE 846B

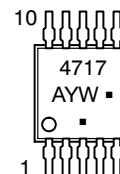

- A = Assembly Location
- Y = Year
- W, WW = Work Week
- = Pb-Free Package

FUNCTION TABLE

IN_	NO_	NC_
0	OFF	ON
1	ON	OFF

ORDERING INFORMATION

Device	Package	Shipping†
NLAS4717FCT1	Flip-Chip-10	3000 / Tape & Reel
NLAS4717FCT1G	Flip-Chip-10 (Pb-Free)	3000 / Tape & Reel
NLAS4717MR2	Micro10	4000 / Tape & Reel
NLAS4717MR2G	Micro10 (Pb-Free)	4000 / Tape & Reel

†For information on tape and reel specifications, including part orientation and tape sizes, please refer to our Tape and Reel Packaging Specifications Brochure, BRD8011/D.

NLAS4717

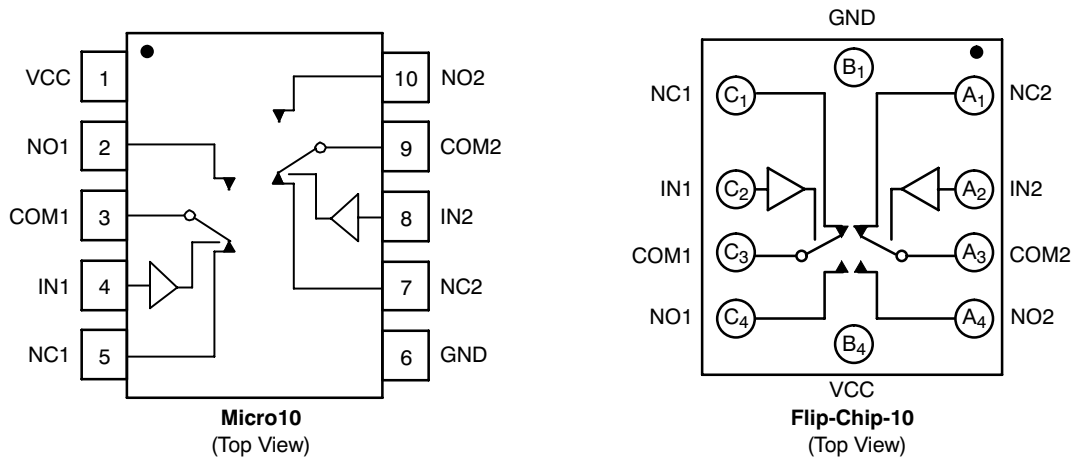

Figure 1. Device Circuit Diagrams and Pin Configurations

MAXIMUM RATINGS

Symbol	Parameter	Value	Unit
V+	Positive DC Supply Voltage	-0.5 to +7.0	V
V _{IS}	Analog Input Voltage (V _{NO} , V _{NC} , or V _{COM}) (Note 1)	-0.5 ≤ V _{IS} ≤ V _{CC} + 0.5	V
V _{IN}	Digital Select Input Voltage	-0.5 ≤ V _I ≤ +7.0	V
I _{IK}	DC Current, Into or Out of Any Pin (Continuous)	± 100	mA
I _{PK}	Peak Current (10% Duty Cycle)	± 200	mA

Stresses exceeding Maximum Ratings may damage the device. Maximum Ratings are stress ratings only. Functional operation above the Recommended Operating Conditions is not implied. Extended exposure to stresses above the Recommended Operating Conditions may affect device reliability.

- Signal voltage on NC, NO, and COM exceeding V_{CC} or GND are clamped by the internal diodes. Limit forward diode current to maximum current rating.

RECOMMENDED OPERATING CONDITIONS

Symbol	Parameter	Min	Max	Unit
V+	DC Supply Voltage	1.8	5.5	V
V _{IN}	Digital Select Input Voltage	GND	5.5	V
V _{IS}	Analog Input Voltage (NC, NO, COM)	GND	V _{CC}	V
T _A	Operating Temperature Range	-40	+85	°C
t _r , t _f	Input Rise or Fall Time, SELECT	V _{CC} = 3.3 V ± 0.3 V 0	100 20	ns/V
		V _{CC} = 5.0 V ± 0.5 V 0		

ANALOG SWITCH DC CHARACTERISTICS

Symbol	Parameter	Condition	V _{CC} (V)	-40 °C to +85 °C		Unit
				Min	Max	
V _{IH}	Input Logic High Voltage	V _{OUT} = 0.1 V I _{OUT} ≤ 20 μA	1.65 to 2.2 2.7 to 3.6 4.5 to 5.5	V _{CC} × 0.55 V _{CC} × 0.5 2.0	- - -	V
V _{IL}	Input Logic Low Voltage	V _{OUT} = -V _{CC} - 0.1 V I _{OUT} ≤ 20 μA	1.65 to 2.2 2.7 to 3.6 4.5 to 5.5	- - -	V _{CC} × 0.2 V _{CC} × 0.2 0.8	V
I _{IN}	Input Leakage Current	V _{IN} = V _{CC} or GND	5.0	-100	+100	nA
V _{CC}	Power Supply Range	All	-	1.65	5.5	V
I _{CC}	Supply Current	V _{IN} = V _{CC} or GND I _{OUT} = 0 μA	1.8 3.3 5.0	- - -	1.0 1.0 1.0	μA
V _{IS}	Analog Signal Range	Key parameter	-	0	V _{CC}	V

NLAS4717

ANALOG SWITCH CHARACTERISTICS - Digital Section (Voltages Referenced to GND)

Symbol	Parameter	Condition	V _{CC} (V)	-40 °C to +85°C			Unit
				Min	Typ	Max	
R _{ON}	ON Resistance (Note 2)	V _{CC} = 3.0 V I _{COM} = 10 mA V _{NO} or V _{NC} = V _{IH} or V _{IL}	3.0	-		4.5	Ω
		V _{CC} = 5.0 V I _{COM} = 10 mA V _{NO} or V _{NC} = V _{IH} or V _{IL}	5.0	-		3.5	
ΔR _{ON}	ON Resistance Match Between Channels (Note 2 and 3)	V _{CC} = 3.6 V I _{COM} = 10 mA V _{NO} or V _{NC} = V _{IH} or V _{IL}	3.6	-	0.1	0.4	Ω
		V _{CC} = 5.5 V I _{COM} = 10 mA V _{NO} or V _{NC} = V _{IH} or V _{IL}	5.5				
R _{FLAT[ON]}	ON Resistance Flatness (Note 4)	I _{COM} = 10 mA V _{IS} = 0 to V _{CC}	3.0	-		1.5	Ω
		I _{COM} = 10 mA V _{IS} = 0 to V _{CC}	5.5	-		1.36	
I _{NO_[OFF]} I _{NC_[OFF]}	NO_, NC_ Off-Leakage Current (Note 5)	V _{CC} = 3.6 V V _{COM} = 0.3 V or 3.3 V V _{NO} or V _{NC} = 0.3 V or 3.3 V	3.6	-1.0	0.01	+1.0	nA
		V _{CC} = 5.5 V V _{COM} = 0 V or 5.0 V V _{NO} or V _{NC} = 0 V or 5.0 V	5.5	-1.0	0.01	+1.0	
I _{COM_[ON]}	COM_ On-Leakage Current (Note 5)	V _{CC} = 3.6 V V _{COM} = 0.3 V or 3.3 V V _{NO} or V _{NC} = 0.3 V or 3.3 V	3.6	-2.0	0.01	+2.0	nA
		V _{CC} = 5.5 V V _{COM} = 0 V or 5.0 V V _{NO} or V _{NC} = 0 V or 5.0 V	5.5	-2.0	0.01	+2.0	

ANALOG SWITCH AC CHARACTERISTICS

Symbol	Parameter	Condition	V _{CC} (V)	-40 °C to +85°C			Unit
				Min	Typ	Max	
t _{ON}	Turn-On Time	V _{NC_} , V _{NO_} = V _{IH} or V _{IL} R _L = 300 Ω, C _L = 35 pF V _{IN[x]} = V _{IH} or V _{IL}	1.8 to 5.5	-	-	30	nS
t _{OFF}	Turn-Off Time	V _{NC_} , V _{NO_} = V _{IH} or V _{IL} R _L = 300 Ω, C _L = 35 pF V _{IN[x]} = V _{IH} or V _{IL}	1.8 to 5.5	-	-	40	nS
t _{BBM}	Break-Before-Make Time Delay (Note 5)	V _{NC_} , V _{NO_} = 1.5 V R _L = 300 Ω, C _L = 35 pF	-	-	8.0	-	nS
t _{SKEW}	Skew (Note 5)	R _S = 39 Ω, C _L = 50 pF	-	-	0.15	2.0	nS

2. R_{ON} characterized for V_{CC} range (1.65 V to 5.5 V).

3. ΔR_{ON} = R_{ON}(MAX) - R_{ON}(MIN).

4. R_{FLAT[ON]} = R_{ON}(MAX) - R_{ON}(MIN), measured over V_{CC} range.

5. Guaranteed by design.

NLAS4717

ANALOG SWITCH APPLICATION CHARACTERISTICS

Symbol	Parameter	Condition	V _{CC} (V)	-40 °C to +85°C			Unit
				Min	Typ	Max	
Q	Charge Injection	V _{IN} = V _{CC} to GND R _{IN} = 0 Ω, C _L = 1.0 nF Q = C _L · ΔV _{OUT}	3.0 5.0		6.0 9.0		pC
VISO	Off-Isolation	f = 10 MHz V _{NO_} , V _{NC_} = 1.0 Vp-p R _L = 50 Ω, C _L = 5.0 pF	1.65 to 5.5		-50		dB
		f = 1.0 MHz V _{NO_} , V _{NC_} = 1.0 Vp-p R _L = 50 Ω, C _L = 5.0 pF			-75		
VCT	Cross-Talk	f = 10 MHz V _{NO_} , V _{NC_} = 1.0 Vp-p R _L = 50 Ω, C _L = 5.0 pF	1.65 to 5.5		-80		dB
		f = 1.0 MHz V _{NO_} , V _{NC_} = 1.0 Vp-p R _L = 50 Ω, C _L = 5.0 pF			-110		
BW	On-Channel -3.0 db Bandwidth	Signal = 0 dB R _L = 50 Ω, C _L = 5.0 pF	1.8 to 5.0		40		MHz
THD	Total Harmonic Distortion	V _{COM} = 2.0 Vp-p, R _L = 600 Ω, T _A = 25°C	-		0.02		%
C _{NO_[OFF]} C _{NC_[OFF]}	NO_, NC_ OFF-Capacitance	F = 10 MHz	-		30		pF
C _{NO_[ON]} C _{NC_[ON]}	NO_, NC_ ON-Capacitance	F = 10 MHz	-		110		pF

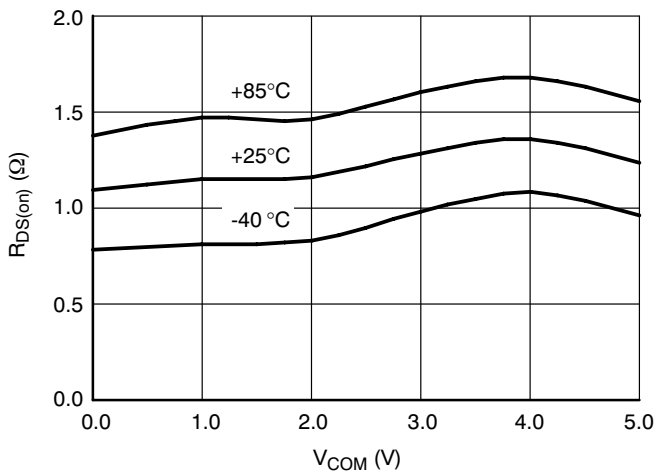

Figure 2. Low $R_{DS(on)}$ @ $V_{CC} = 5.0$ V

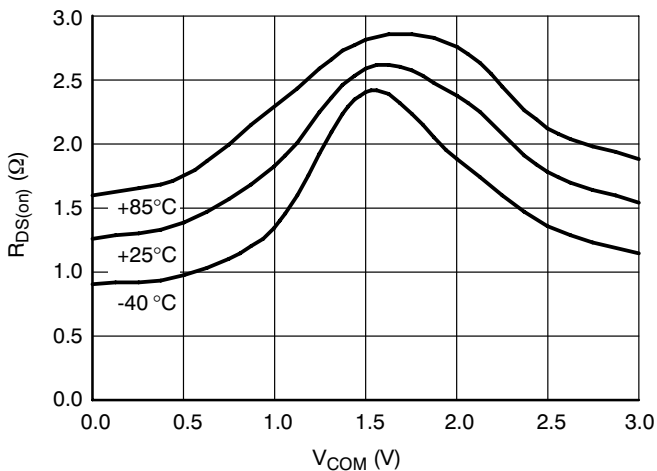

Figure 3. Low $R_{DS(on)}$ @ $V_{CC} = 3.0$ V

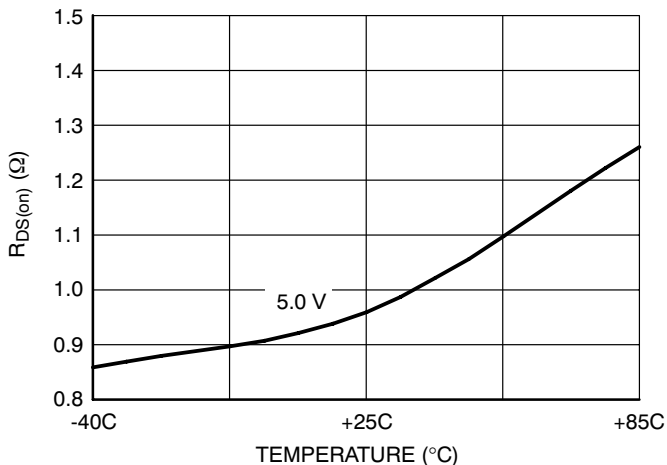

Figure 4. Delta $R_{DS(on)}$ @ $V_{CC} = 5.0$ V

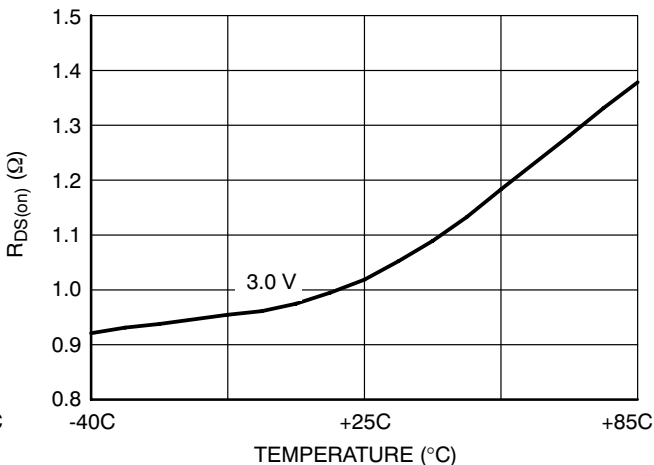

Figure 5. Delta $R_{DS(on)}$ @ $V_{CC} = 3.0$ V

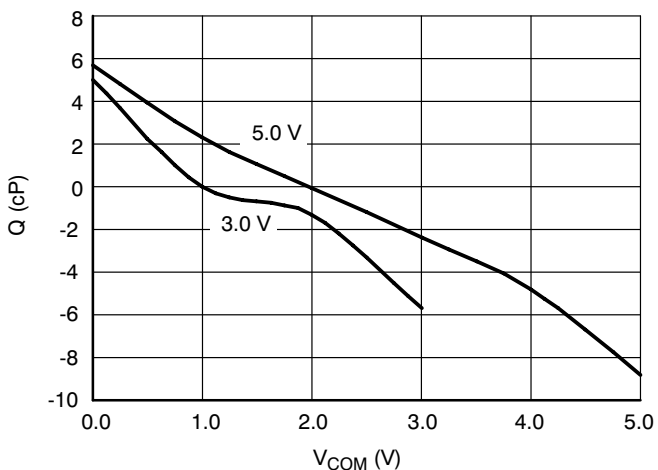

Figure 6. Charge Injection

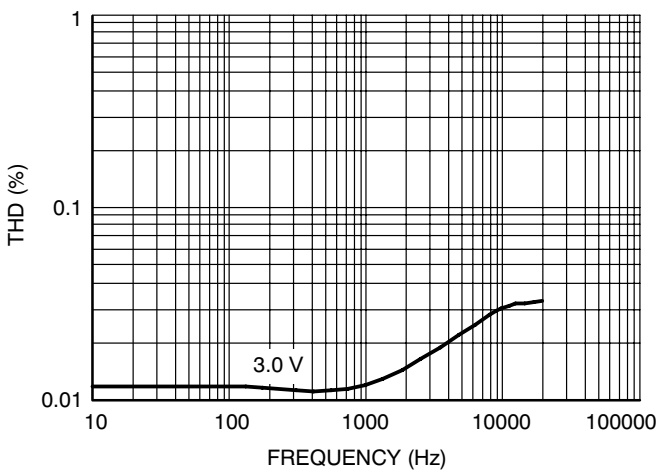

Figure 7. Total Harmonic Distortion

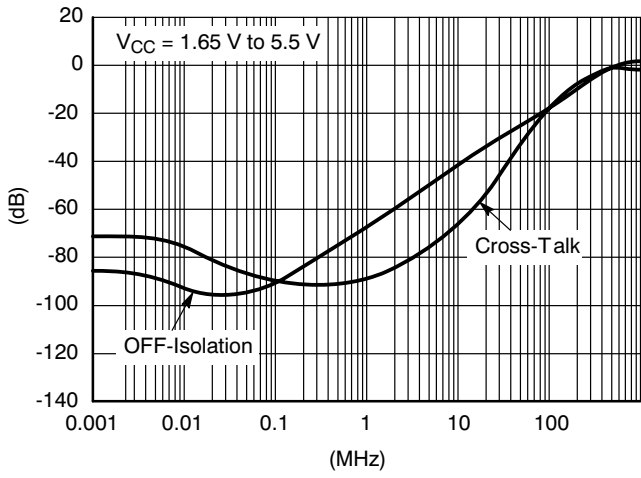

Figure 8. Frequency Response

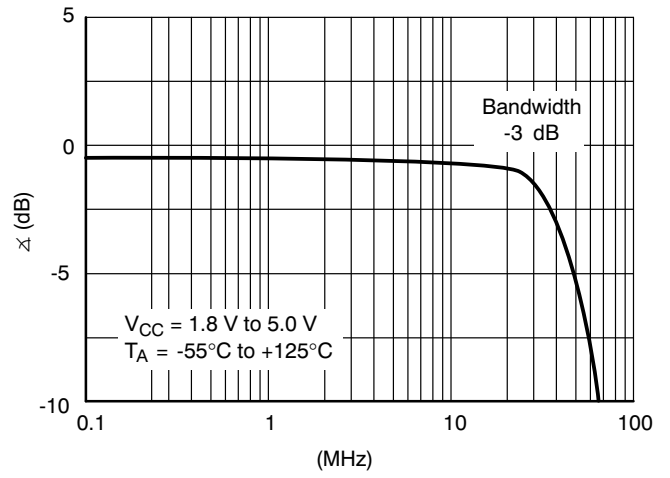

Figure 9. Bandwidth and Phase

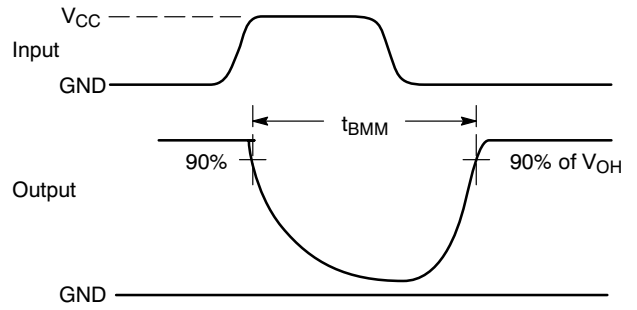
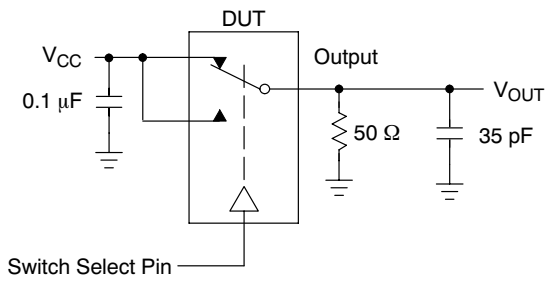

Figure 10. t_{BMM} (Time Break-Before-Make)

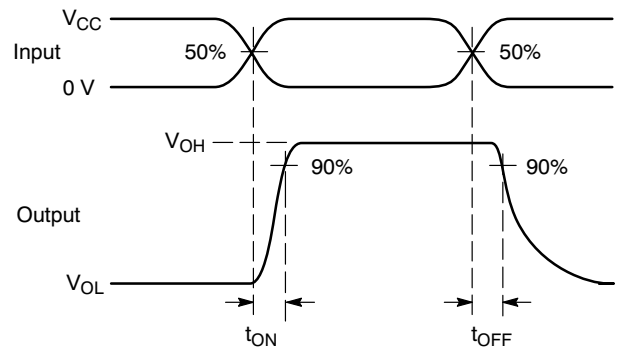
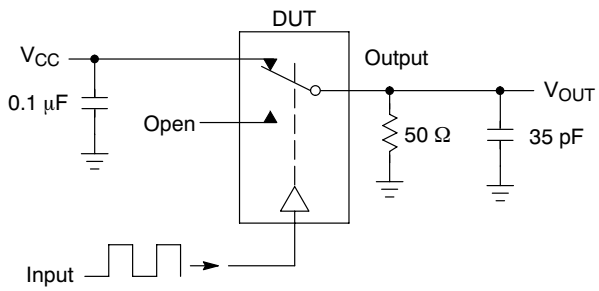

Figure 11. t_{ON}/t_{OFF}

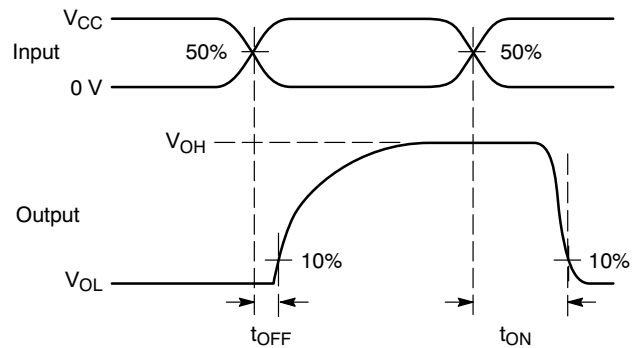
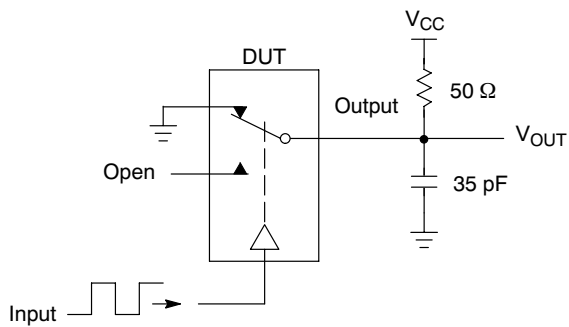
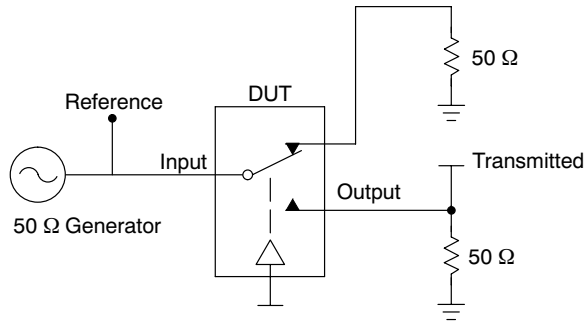

Figure 12. t_{ON}/t_{OFF}

NLAS4717



Channel switch control/s test socket is normalized. Off isolation is measured across an off channel. On loss is the bandwidth of an On switch. V_{ISO} , Bandwidth and V_{ONL} are independent of the input signal direction.

$$V_{ISO} = \text{Off Channel Isolation} = 20 \text{ Log} \left(\frac{V_{OUT}}{V_{IN}} \right) \text{ for } V_{IN} \text{ at } 100 \text{ kHz}$$

$$V_{ONL} = \text{On Channel Loss} = 20 \text{ Log} \left(\frac{V_{OUT}}{V_{IN}} \right) \text{ for } V_{IN} \text{ at } 100 \text{ kHz to } 50 \text{ MHz}$$

Bandwidth (BW) = the frequency 3.0 dB below V_{ONL}

V_{CT} = Use V_{ISO} setup and test to all other switch analog input/outputs terminated with 50 Ω

Figure 13. Off Channel Isolation/On Channel Loss (BW)/Crosstalk (On Channel to Off Channel)/ V_{ONL}

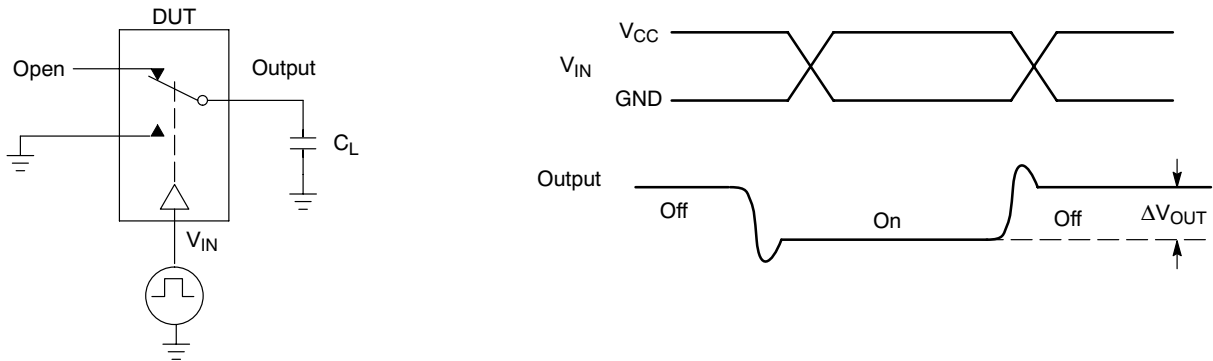

Figure 14. Charge Injection: (Q)

MECHANICAL CASE OUTLINE

PACKAGE DIMENSIONS

ON Semiconductor®



10 PIN FLIP-CHIP CASE 489AA-01 ISSUE A

DATE 04 MAY 2004

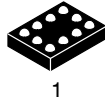

1

SCALE 4:1

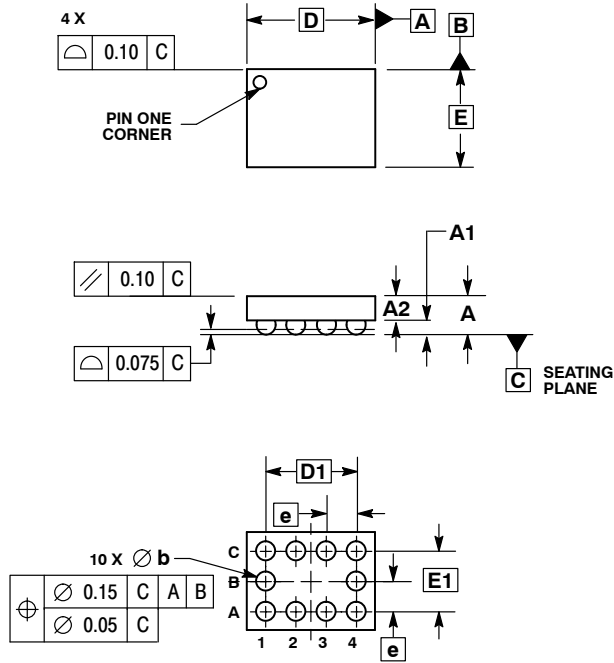

NOTES:

1. DIMENSIONING AND TOLERANCING PER ASME Y14.5M, 1994.
2. CONTROLLING DIMENSION: MILLIMETERS.
3. COPLANARITY APPLIES TO SPHERICAL CROWNS OF SOLDER BALLS.

DIM	MILLIMETERS	
	MIN	MAX
A	---	0.650
A1	0.210	0.270
A2	0.280	0.380
D	1.965 BSC	
E	1.465 BSC	
b	0.250	0.350
e	0.500 BSC	
D1	1.500 BSC	
E1	1.000 BSC	

GENERIC MARKING DIAGRAM*

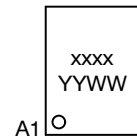

- xxxx = Specific Device Code
- YY = Year
- WW = Work Week

*This information is generic. Please refer to device data sheet for actual part marking. Pb-Free indicator, "G" or microdot "▪", may or may not be present.

DOCUMENT NUMBER:	98AON12946D	Electronic versions are uncontrolled except when accessed directly from the Document Repository. Printed versions are uncontrolled except when stamped "CONTROLLED COPY" in red.
DESCRIPTION:	10 PIN FLIP-CHIP	PAGE 1 OF 1

ON Semiconductor and ON are trademarks of Semiconductor Components Industries, LLC dba ON Semiconductor or its subsidiaries in the United States and/or other countries. ON Semiconductor reserves the right to make changes without further notice to any products herein. ON Semiconductor makes no warranty, representation or guarantee regarding the suitability of its products for any particular purpose, nor does ON Semiconductor assume any liability arising out of the application or use of any product or circuit, and specifically disclaims any and all liability, including without limitation special, consequential or incidental damages. ON Semiconductor does not convey any license under its patent rights nor the rights of others.

MECHANICAL CASE OUTLINE PACKAGE DIMENSIONS

ON Semiconductor®

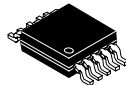

SCALE 2:1

Micro10
CASE 846B-03
ISSUE D

DATE 07 DEC 2004

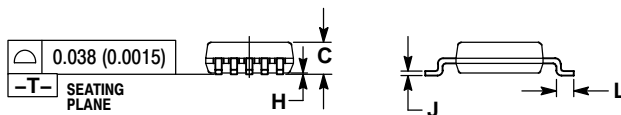
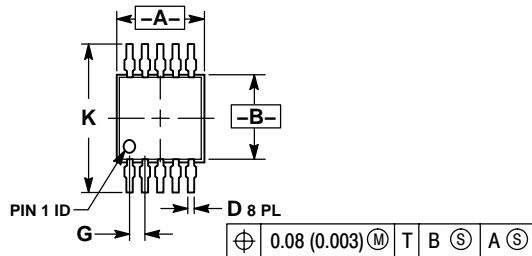

NOTES:

1. DIMENSIONING AND TOLERANCING PER ANSI Y14.5M, 1982.
2. CONTROLLING DIMENSION: MILLIMETER.
3. DIMENSION "A" DOES NOT INCLUDE MOLD FLASH, PROTRUSIONS OR GATE BURRS. MOLD FLASH, PROTRUSIONS OR GATE BURRS SHALL NOT EXCEED 0.15 (0.006) PER SIDE.
4. DIMENSION "B" DOES NOT INCLUDE INTERLEAD FLASH OR PROTRUSION. INTERLEAD FLASH OR PROTRUSION SHALL NOT EXCEED 0.25 (0.010) PER SIDE.
5. 846B-01 OBSOLETE. NEW STANDARD 846B-02

DIM	MILLIMETERS		INCHES	
	MIN	MAX	MIN	MAX
A	2.90	3.10	0.114	0.122
B	2.90	3.10	0.114	0.122
C	0.95	1.10	0.037	0.043
D	0.20	0.30	0.008	0.012
G	0.50 BSC		0.020 BSC	
H	0.05	0.15	0.002	0.006
J	0.10	0.21	0.004	0.008
K	4.75	5.05	0.187	0.199
L	0.40	0.70	0.016	0.028

GENERIC MARKING DIAGRAM*



- xxxx = Device Code
- A = Assembly Location
- Y = Year
- W = Work Week
- = Pb-Free Package

*This information is generic. Please refer to device data sheet for actual part marking. Pb-Free indicator, "G" or microdot "▪", may or may not be present.

SOLDERING FOOTPRINT

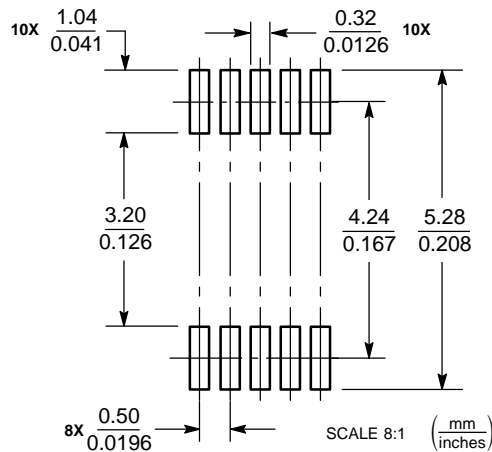

Micro10

DOCUMENT NUMBER:	98AON03799D	Electronic versions are uncontrolled except when accessed directly from the Document Repository. Printed versions are uncontrolled except when stamped "CONTROLLED COPY" in red.
STATUS:	ON SEMICONDUCTOR STANDARD	
NEW STANDARD:		
DESCRIPTION:	Micro10	PAGE 1 OF 2

onsemi, **Onsemi**, and other names, marks, and brands are registered and/or common law trademarks of Semiconductor Components Industries, LLC dba "**onsemi**" or its affiliates and/or subsidiaries in the United States and/or other countries. **onsemi** owns the rights to a number of patents, trademarks, copyrights, trade secrets, and other intellectual property. A listing of **onsemi**'s product/patent coverage may be accessed at www.onsemi.com/site/pdf/Patent-Marking.pdf. **onsemi** reserves the right to make changes at any time to any products or information herein, without notice. The information herein is provided "as-is" and **onsemi** makes no warranty, representation or guarantee regarding the accuracy of the information, product features, availability, functionality, or suitability of its products for any particular purpose, nor does **onsemi** assume any liability arising out of the application or use of any product or circuit, and specifically disclaims any and all liability, including without limitation special, consequential or incidental damages. Buyer is responsible for its products and applications using **onsemi** products, including compliance with all laws, regulations and safety requirements or standards, regardless of any support or applications information provided by **onsemi**. "Typical" parameters which may be provided in **onsemi** data sheets and/or specifications can and do vary in different applications and actual performance may vary over time. All operating parameters, including "Typicals" must be validated for each customer application by customer's technical experts. **onsemi** does not convey any license under any of its intellectual property rights nor the rights of others. **onsemi** products are not designed, intended, or authorized for use as a critical component in life support systems or any FDA Class 3 medical devices or medical devices with a same or similar classification in a foreign jurisdiction or any devices intended for implantation in the human body. Should Buyer purchase or use **onsemi** products for any such unintended or unauthorized application, Buyer shall indemnify and hold **onsemi** and its officers, employees, subsidiaries, affiliates, and distributors harmless against all claims, costs, damages, and expenses, and reasonable attorney fees arising out of, directly or indirectly, any claim of personal injury or death associated with such unintended or unauthorized use, even if such claim alleges that **onsemi** was negligent regarding the design or manufacture of the part. **onsemi** is an Equal Opportunity/Affirmative Action Employer. This literature is subject to all applicable copyright laws and is not for resale in any manner.

PUBLICATION ORDERING INFORMATION

LITERATURE FULFILLMENT:

Email Requests to: orderlit@onsemi.com

onsemi Website: www.onsemi.com

TECHNICAL SUPPORT

North American Technical Support:

Voice Mail: 1 800-282-9855 Toll Free USA/Canada

Phone: 011 421 33 790 2910

Europe, Middle East and Africa Technical Support:

Phone: 00421 33 790 2910

For additional information, please contact your local Sales Representative