

Baby with redundancy

PULS

SLR2.5

- Input: AC 230V/115V, DC 160-375V
- Output: 24V/2.5A
- High overload current, no switch-off
- Quasi-Wide-Range Input
- N+1 redundancy, RDY relay contact
- NEC Class 2 Power Supply



The Redundant Variant

CB
scheme
IEC60950

UL US

UL508 LISTED
IND. CONT. EQ.
18 WIM, 60°C

UL US
UL60950 E137005
CUL/CSA-C22.2
No 950-M90

CE

EMC and
Low Volt:
Directive

Data sheet

Input

Input voltage	AC100-120/220-240 V (switchable), 47-63 Hz (85-132 VAC / 176-264 VAC, 160-375 VDC, see also „Output: Continuous Loading“)
Quasi-Wide-Range Input: With the switch in the 230V position the power-supply unit operates at low and moderate loads at any input voltage between 95 and 264 V AC (see 'Output' at the right side). Note: At DC input, always leave the switch in the 230V position	
Input current	< 1.3 A (switch in 115V position) < 0.7 A (switch in 230V position)
DC input current at open output	typ. 5.3 mA at 110 VDC, 3.9 mA at 300 VDC (preserves battery sources)
Inrush current	typ. < 25 A at 264 V AC and cold start
To be fused with a 10A, B-type 'circuit-breaker' switch based on the usual thermomagn. overload sensing principle (used anyway to fuse the input lines). In addition, the unit contains an internal fuse (not accessible)	
Transient handling	Transient resistance acc. to VDE 0160 / W2 (750 V / 1.3 ms), for all load conditions.
Hold up time	> 20 ms at 196 VAC, 24 V / 2.5 A (see diagram overleaf)

Efficiency, Reliability etc.*

Efficiency	typ. 86.5 % (230 VAC, 24 V / 2.5 A)
Losses	typ. 9.4 W (230 VAC, 24 V / 2.5 A)
MTBF	700,000 h acc. to Siemensnorm SN 29500 (24 V/2.5 A, 230 VAC, T _{amb} = +40 °C)
Life cycle (electrolytics)	The unit exclusively uses longlife electrolytics, specified for +105°C (cf. 'The SilverLine', p.2).

Construction / Mechanics*

Housing dimensions and Weight

- W x H x D 49 mm x 124 mm x 102 mm (+ DIN rail)
- Free space for ventilation above/below 25 mm recommended
- Weight right 10 mm recommended (front view) 470 g

Design advantages:

- Input and output pluggable by means of Combicon® plug connector.
- Ensure strain relief of the plug connectors when installing the unit. 
- Input and output are strictly apart from each other and so cannot be mixed up (input below, output above).

Order information

Order number	Description
SLR2.100	N+1 redundancy*
SL2.100	Basic version without redundancy*
SLZ01	Screw mounting set, two needed per unit

Output

Rated output voltage	24 V DC
For balanced current sharing during parallel operation: Soft characteristic (25.2 V DC ±2% at no-load, 24 V DC ±0.5% at nominal load, almost linear characteristic curve)	
Output noise suppression	Radiated EMI values below EN 61000-6-3, even when using long, unscreened output cables.
Ambient temperature range T _{amb}	Operation: -10°C...+70°C (>60°C: Derating) Storage: -25°C...+85°C
Continuous loading (at T _{amb} = -10°C...+60°C, convection cooling), see also diagram overleaf. For start at T _{amb} <0°C and low input voltage, please contact PULS.	Switch AC/DCin Iout
* For start with DC input > 95 V DC needed	230V 176-264 V ACin 2,5 A
	95-176 V ACin 1,5 A
	160-375 V DCin 2,5 A
	120-160 V DCin 2,0 A
	80*-120 V DCin 1,5 A

Output protected against short circuit, open circuit and overload	
Derating	typ. 1.5 W/K (at T _{amb} =+60°C...+70°C)
Voltage regulation	better than 2% V _{out} overall
Ripple / Noise	< 30 mV _{pp} , (20 MHz bandw., 50 Ω measur.)
Overvolt. protection	typ. 32 V
Parallel operation	yes; current sharing via soft characteristic (see diagram)
Power back immunity	26 V
Front panel indicator	Green LED
RDY relay contact	
• Type	normally open contact
• closes	when output voltage > 22.1V ±4%
• opens	when output voltage < 19.8V ±4%
• Electrical isolation	500V DC to output voltage
• Contact rating	1A at 28V DC

* *For further information see data sheets „The SilverLine“, „SilverLine Family Branches“ and mechanics data sheet

Start / Overload Behaviour

Start-up delay	typ. 0.1 s
Rise time	ca. 5-20 ms, depending on load

- Overload Behaviour
- Special PULS Overload Design (see right diagram)
 - no disconnection, no hiccup if overloaded
 - high overload current (up to $1.5 I_{Nom}$), V_{out} is gradually reduced with increasing current.

- Advantages:
- High short-circuit current, giving large 'start-up window': unit starts reliably even with awkward loads (DC-DC converters, motors).
 - No 'sticking' such as can occur with fold-back characteristics
 - Secondary fuses operate reliably

Further information

- Further information, especially about
- EMC
 - Connections
 - Safety, Approvals
 - Mechanics and Mounting
- see page 2 of „The SilverLine“ data sheet.

For detailed dimensions
see SilverLine mechanics data sheet SLR2.5/ 5/ 10

Power wiring

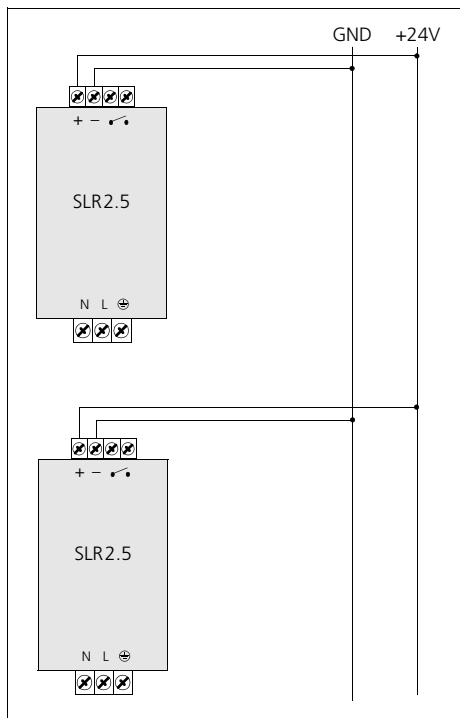

Output characteristic (min.)

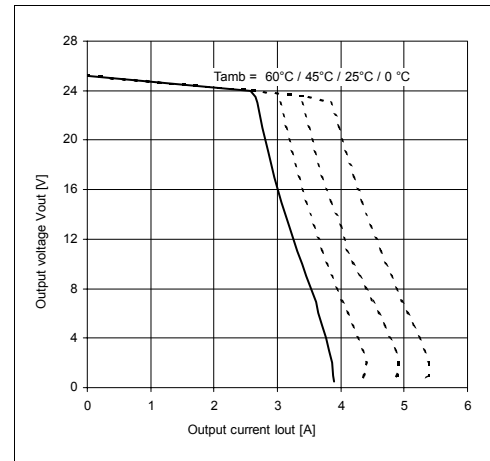

Output Current over Input Voltage (min.)

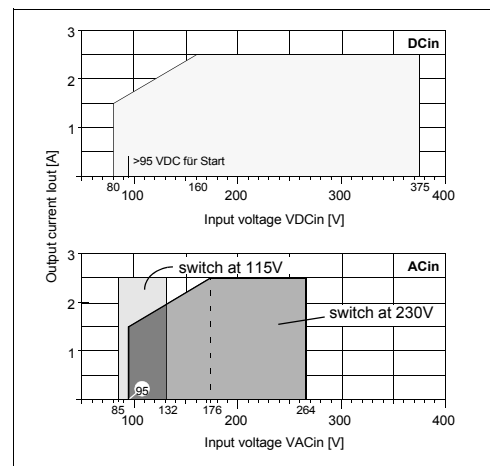

Hold-up time (min.)

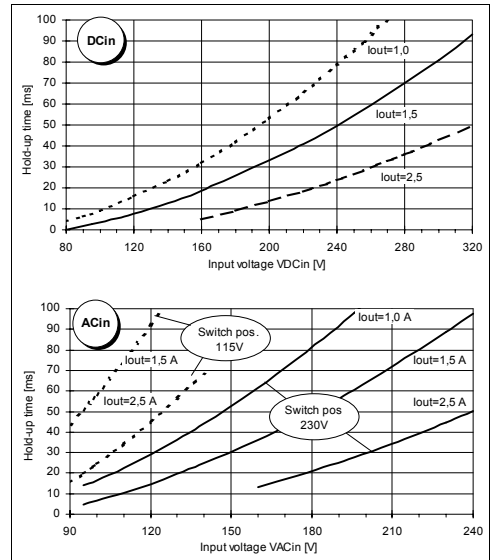

Unless otherwise stated, specifications are valid for AC 230V input voltage, +25°C ambient temperature, and 5 min. run-in time. They are subject to change without prior notice.

Your partner in power supply:



Bayerns Best 50
Czech 100 Best
EuropeOs 500

PULS GmbH
 Arabellastraße 15
 D-81925 München
 Tel.: +49 89 9278-0
 Fax: +49 89 9278-199
 www.puls-power.com

SLR2.5 /SLR5 / SLR10

- Innovative DIN-Rail mount, unit holds even at vibration or lateral pressure
- Clearly arranged and user oriented
- Large, robust plug connectors
- Sealed metal housing
- Fine ventilating grid



Data sheet

Side view SLR2.5

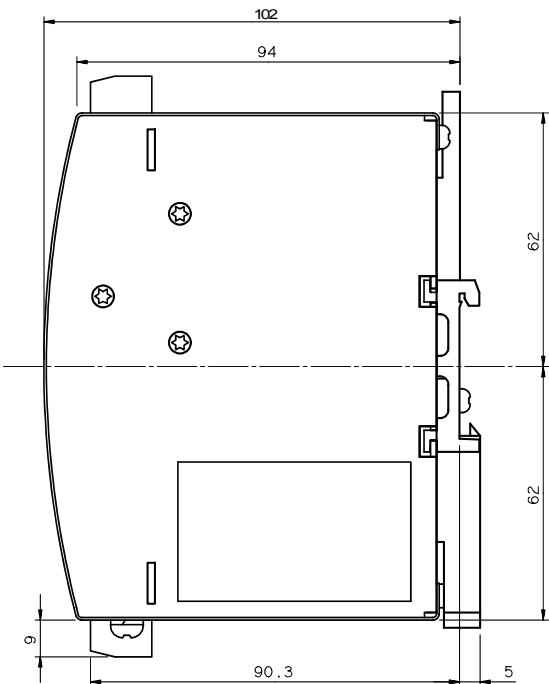

Front view SLR2.5

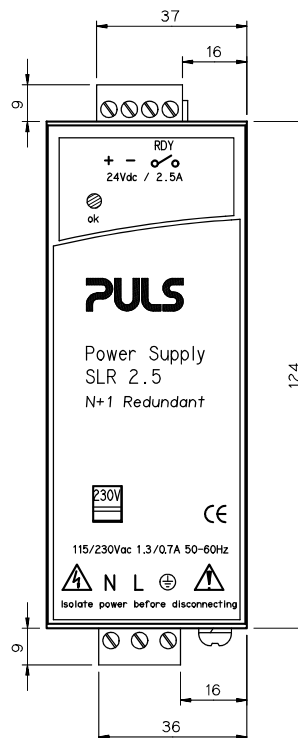

Bottom view SLR2.5

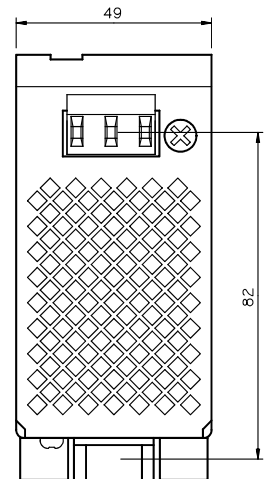

Construction / Mechanics

Unit	Housing dimensions and Weight		Free space for ventilation		
	W x H x D [mm]	weight	left	above/below	right
• SLR2.5	49 x 124 x 102	470 g	0 mm	25 mm each	10 mm
• SLR5.100	64 x 124 x 102	620 g	15 mm	25 mm each	15 mm
• SLR10.10	120 x 124 x 102	980 g	15 mm	25 mm each	15 mm

Overall depth = depth value as mentioned + DIN rail depth

Robust metal housing with fine ventilat. grid (◇ 3,5 mm, IP20), to keep out small parts (e.g. screws)

Mounting	on DIN-Rail (TS35/7.5 or TS35/15, 1...1.5 mm thick), thus
	<ul style="list-style-type: none"> • Simple snap-on system • Sits safely and firmly on the DIN-Rail • No tools required to remove
	or backplane-mounted (two optional screw mounting sets SLZ01 required)

Connections

Connections	stable plug connectors, connector size range: 0.2 – 2.5 mm ²
• Input	0.2 – 2.5 mm ² , SLR10: 0.2 – 4 mm ²
• Output	
• Current handling capacity	12 A each (SLR10: 20 A each)
• Grid	7.62 mm (input) / 5.08 mm (output) distance between adjacent connectors
	SLR10: 7.62 mm (output)
Design advantages:	<ul style="list-style-type: none"> • All connection blocks are easy to reach as mounted at the front panel. • Input and output are strictly apart from each other and so cannot be mixed up

Order information

Order number	Description
SLR2.5: 24V/2.5A	
SLR5.100: 24V/5A	
SLR10.100: 24V/10A	
SLZ01	Screw mounting set, two needed per unit

**Side view and front view
SLR5.100**

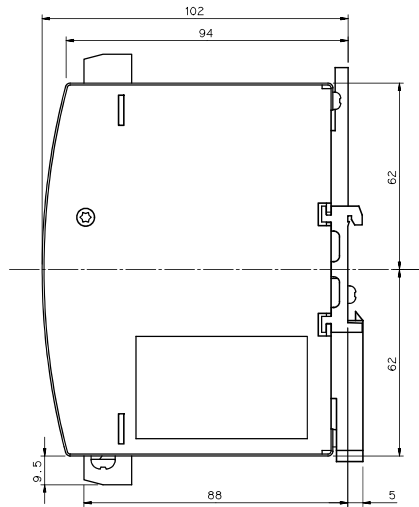
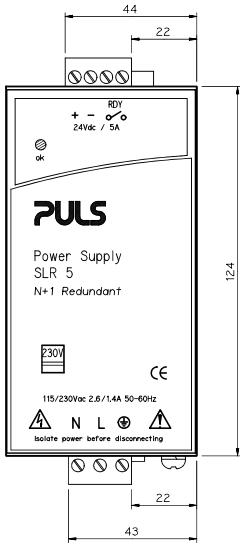

**Bottom view
SLR5.100**

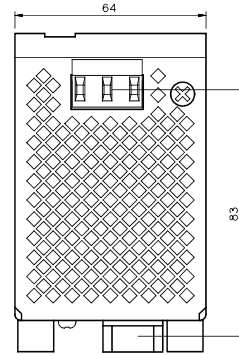

**Side view and front view
SLR10.100**

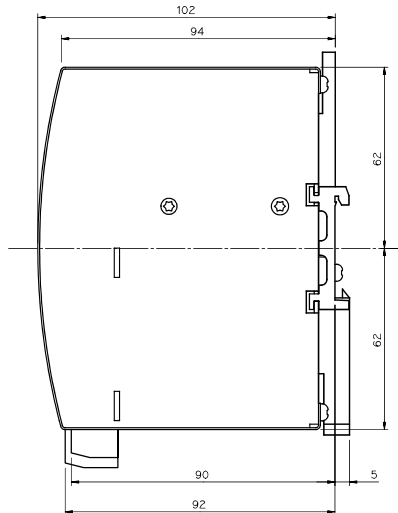
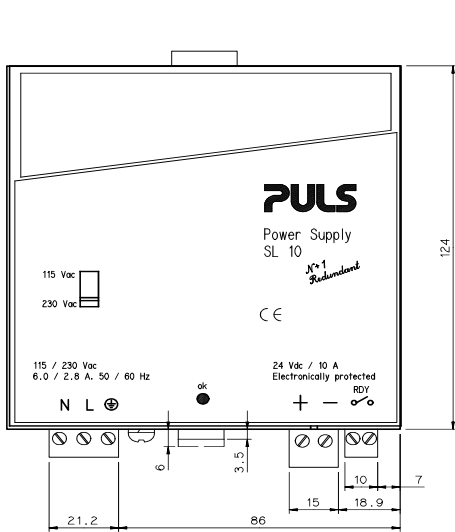

**Bottom view
SLR10.100**

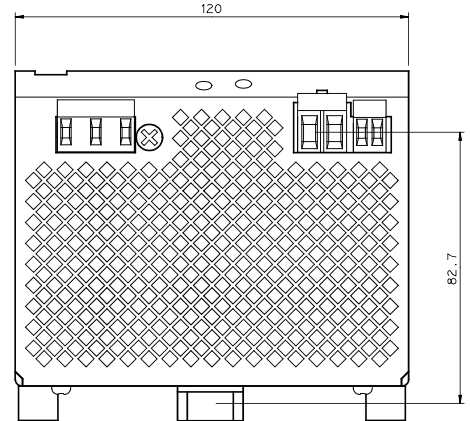

his 'mechanics data sheet' exclusively deals with the mechanical properties of the product. For further information (especially concerning electrical properties), please refer to the generic data sheet of the SLR2.5, SLR5.100 and SLR10.100 and to the basic data sheet „The SilverLine“ dealing with common features of all SilverLine units. This data sheet is subject to change without prior notice.

Your partner in power supply:



PULS GmbH
 Arabellastraße 15
 D-81925 München
 Tel.: +49 89 9278-0
 Fax: +49 89 9278-199
 www.puls-power.com