

1.575 GHz Helical GPS SMD Antenna

Ground cleared under antenna, clearance area 7.50 x 5.50 mm

Pulse Part Number: W3110



Features

- Low profile (5.5 mm)
- Compact size WxLxH (5.0 x 2.5 x 5.5 mm)
- Low weight (170 mg)
- Lead free materials
- Fully SMD compatible
- Lead free soldering compatible
- Tape and reel packing
- RoHS Compliant Product

Applications

- 1.575 GHz L1 band GPS receivers

Engineering samples available

Electrical specifications @ +25 °C

Note: Electrical characteristics depend on test board (GP) size and antenna positioning on GP and Ground Clearance area size.

1.575 GHz GPS

Typical performance (test board size 80 x 37 mm, PWB ground clearance area 7.50 x 5.50 mm)

Antenna measured on the test PWB with plastic covers and with matching circuit. Antenna location: top corner, left.

Frequency Range [MHz]	RHCP Gain [dBic]	Linear Max Gain [dBi]	Efficiency [%] / [dB]	Return loss min. [dB]	Impedance [Ω]	Operating Temperature [°C]
1575.42 +/- 10	-2.1 (Peak) -2.4 (Band edges)	1.3 (Peak) 0.7 (Band edges)	47 / -3.3 (Peak) 43 / -3.7 (Band edges)	-16	50	-40 to +85

Pulse Finland Oy

Takatie 6
90440 Kempele, Finland
Tel: +358 207 935 500
Fax: +358 207 935 501
www.pulseeng.com/antennas



1.575 GHz Helical GPS SMD Antenna

Ground cleared under antenna, clearance area 7.50 x 5.50 mm

Terminal Configuration

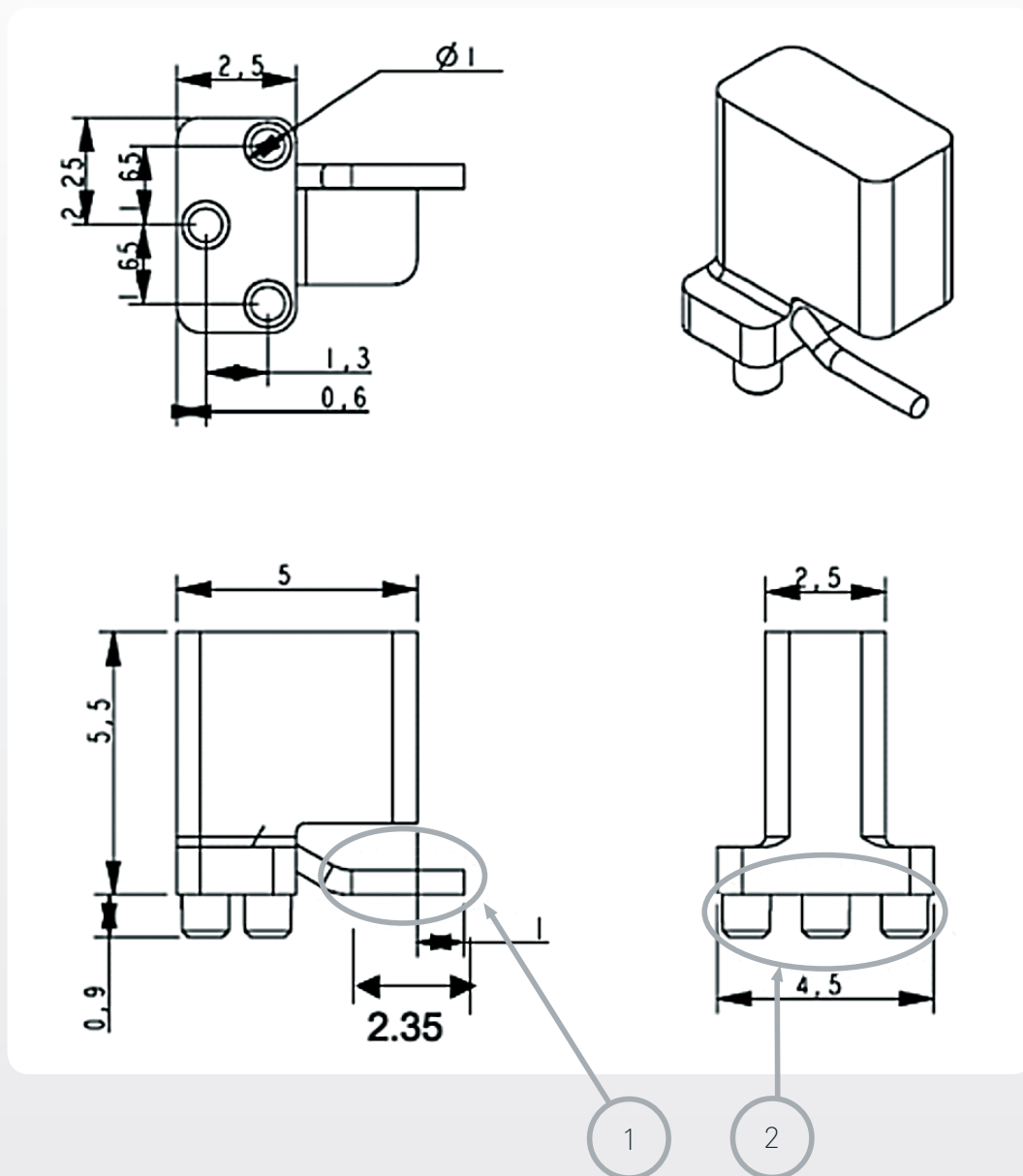

No.	Terminal Name	Terminal Dimensions
1	Feed	0.50 mm diameter Sn plated wire, planar soldering area length 2.35 mm
2	Mechanical support studs	1.00 mm diam, length 0.90 mm

Pulse Finland Oy

Takatie 6
90440 Kempele, Finland

Tel: +358 207 935 500

Fax: +358 207 935 501

www.pulseeng.com/antennas



1.575 GHz Helical GPS SMD Antenna

Ground cleared under antenna, clearance area 7.50 x 5.50 mm

Recommended test board layout for electrical characteristic measurement, test board outline size 100 x 40 mm

Feed line should be designed to match 50 Ω characteristic impedance, depending on PWB material and thickness.

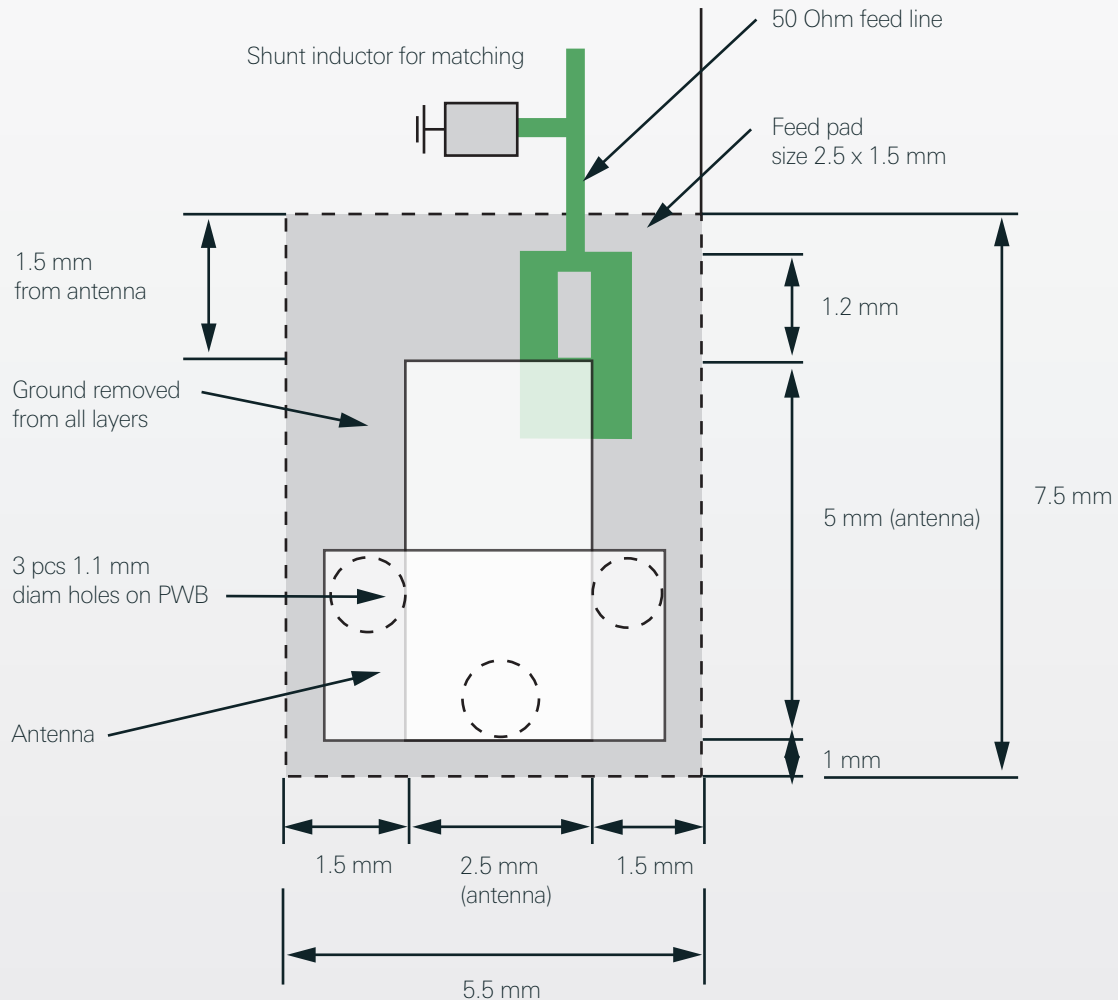

Matching and tuning component values depend on application and surrounding mechanics / materials.

Pulse Finland Oy

Takatie 6
90440 Kempele, Finland
Tel: +358 207 935 500
Fax: +358 207 935 501
www.pulseeng.com/antennas



1.575 GHz Helical GPS SMD Antenna

Ground cleared under antenna, clearance area 7.50 x 5.50 mm

Typical Electrical Characteristics (T=25 °C)

Antenna measured on the test PWB with plastic cover. Shunt and series inductors used for matching.

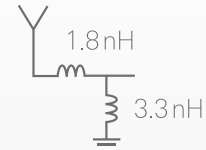

Typical Return Loss S11/ impedance

GPS ANTENNA

24 Aug 2006 08:44:11

CH1Markers

- 1. -17.512 dB 1.56500 GHz
- 2. -32.040 dB 1575.420000 MHz
- 3. -16.539 dB 1.58500 GHz

CH1 S11 LOG

5 dB/REF 0 dB

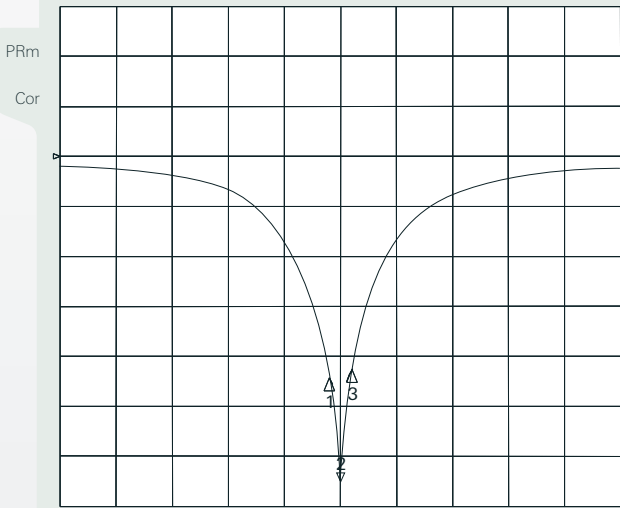

CENTER 1 575.420 000 MHz

SPAN 500.000 000 MHz

GPS ANTENNA

24 Aug 2006 08:45:11

CH1Markers

- 1. 61.484 Ω 9.2539 Ω 1.56500 GHz
- 2. 50.723 Ω -2.2129 Ω 45.652 pF 1.575.420 000 MHz
- 3. 39.158 Ω -6.7895 Ω 1.58500 GHz

CH1 S11 1 U FS

PRm

Del

Cor

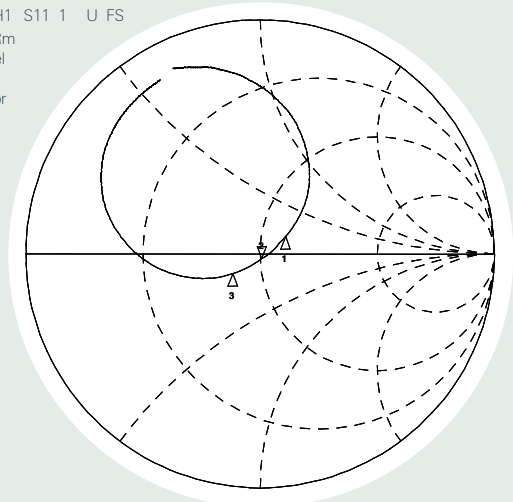

CENTER 1 575.420 000 MHz

SPAN 500.000 000 MHz

Free space efficiency and maximum gain

PWB ground clearance area 7.50 x 5.50 mm

GPS 5.5 mm Helical Antenna

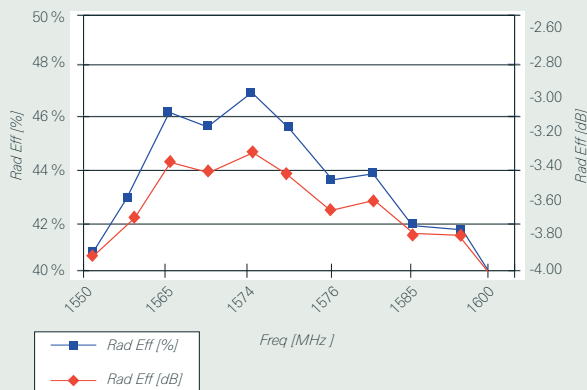

GPS 5.5 mm Helical Antenna

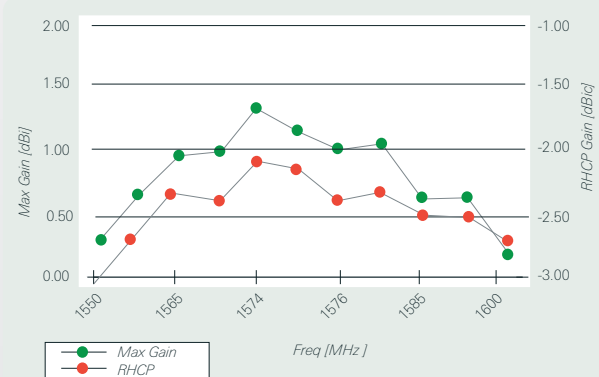

Pulse Finland Oy

Takatie 6
90440 Kempele, Finland
Tel: +358 207 935 500
Fax: +358 207 935 501
www.pulseeng.com/antennas



1.575 GHz Helical GPS SMD Antenna

Ground cleared under antenna, clearance area 7.50 x 5.50 mm

Typical Free Space Radiation Patterns

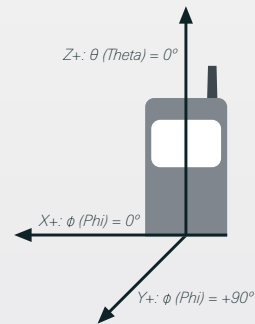
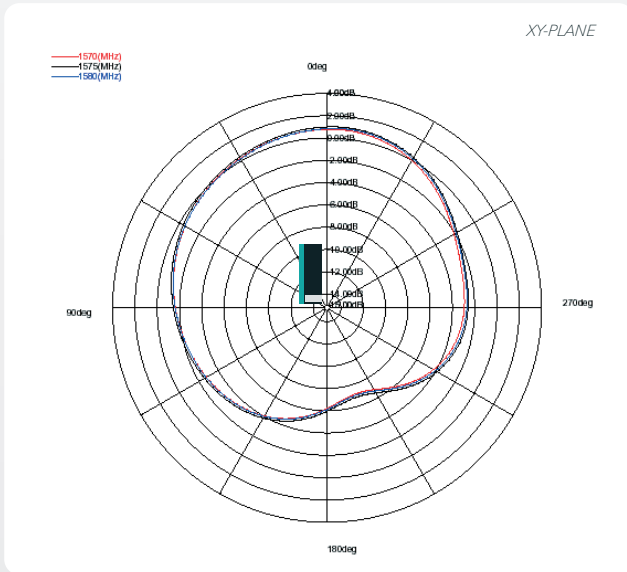
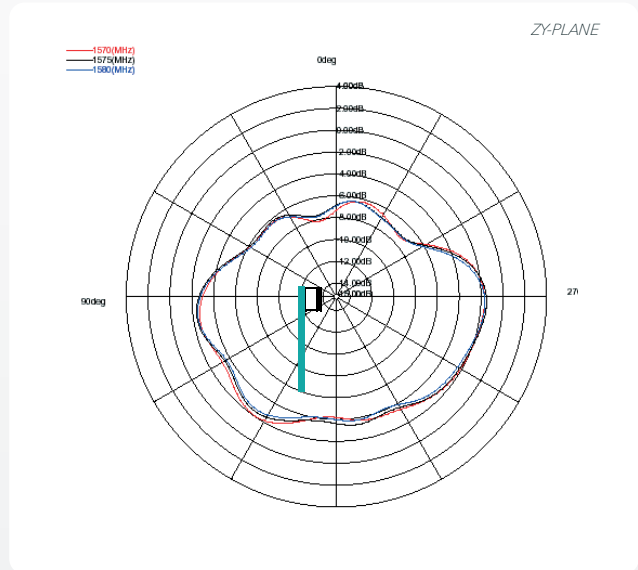
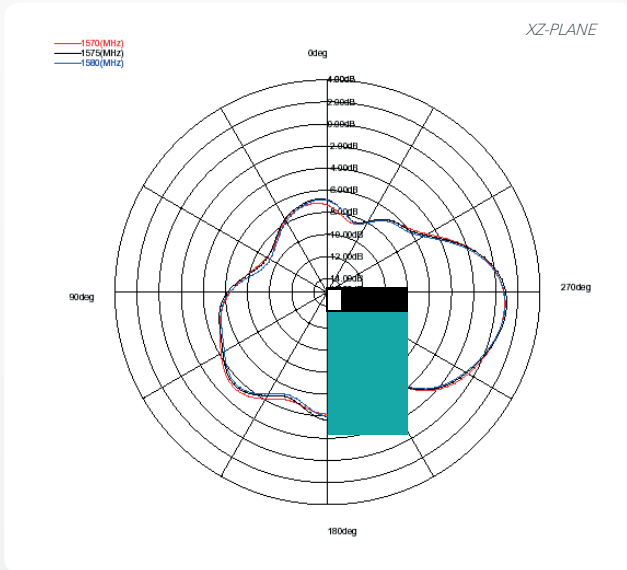

Pulse Finland Oy

Takatie 6
90440 Kempele, Finland
Tel: +358 207 935 500
Fax: +358 207 935 501

www.pulseeng.com/antennas

