

REVISION RECORD				
REV	ECO	DESCRIPTION	DRFT	CHKD
△		ADD TYPE	YANGLAN 06/23/05	
△		Drawing Modify	YANGLAN 06/22/05	

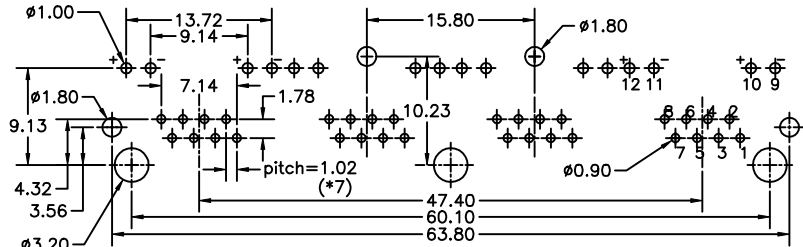

PC Board Layout (t=1.60mm)  
Component Side Shown

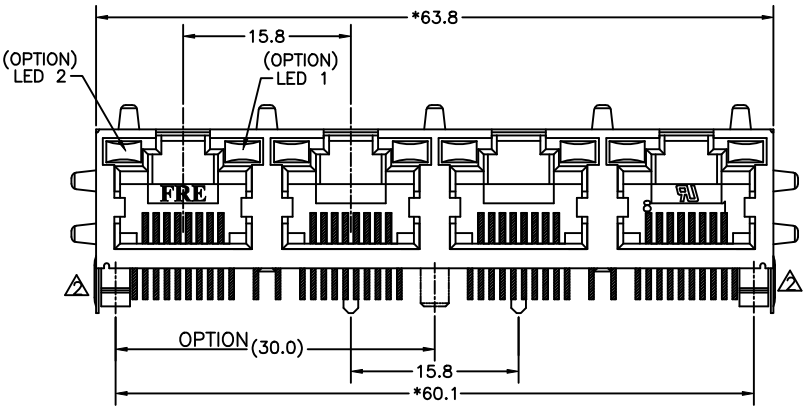

NOTES:

ELECTRICAL:

- VOLTAGE RATING : 125 VAC RMS.
- CURRENT RATING : 1.5 AMP.
- CONTACT RESISTANCE : 30 MILLIOHMS MAX.
- INSULATION RESISTANCE: 1000 MEGOHMS MIN @ 500 VDC.
- DIELECTRIC STRENGTH : 1000 VAC RMS 60Hz, 1MIN.
- LED RATINGS: FORWARD VOLTAGE: 2.2 VOLTS TYPICAL.  
REVERSE VOLTAGE: 5 VOLTS MAXIMUM
- OPERATING: 750 CYCLES MIN.

MECHANICAL:

- HOUSING MATERIAL : PBT+30%.G.F UL94V-0. COLOR-BLACK.
- INSERT MATERIAL : PBT+30%GF UL94V-0. COLOR-BLACK.
- BACK PLATE MATERIAL : PBT+30%GF. COLOR-BLACK.
- LED SIZE : 3.2\*2.0\*7.0\*P=2.54mm.
- SHIELD MATERIAL : COPPER ALLOY 0.25mm THICKNESS PLATING NI.
- CONTACT MATERIAL : PHOSPHOR BRONZE 0.35mm THICKNESS OR 0.46mm.
- PLATING : GOLD PLATING OVER NICKEL.
- PCB RETENTION PRE-SOLDER : 1 LB MIN.
- PCB RETENTION POST-SOLDER: 10 LBS MIN.

ENVIRONMENTAL:

- STORAGE : -40°C TO +85°C.
  - OPERATION: 0°C TO 70°C.
  - WAVE SOLDERING TEMPERATURE:230~250°C(5~10 SECONDS)
- MATES WITH MODULAR PLUG CONFORMING TO FCC PART 68, SUBPART F.

CUL FILE No:E163191

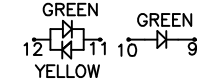
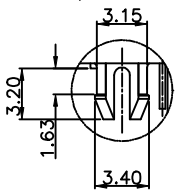
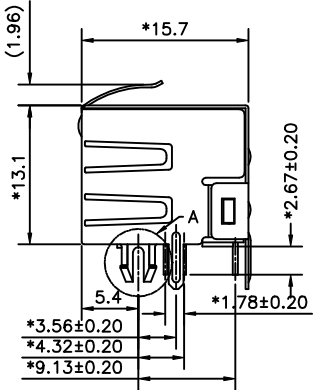
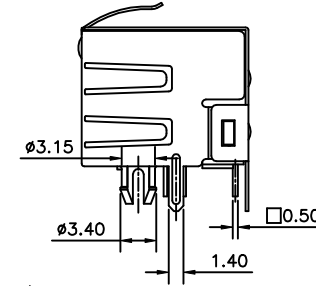

FOR P/N:E5J88-NXCOXX-L

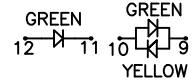

△ FOR P/N:E5J88-KXCOXX-L

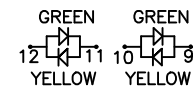

FOR P/N:E5J88-4XCOXX-L

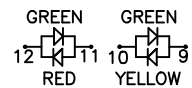

FOR P/N:E5J88-QXCOXX-L

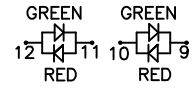

FOR P/N:E5J88-DXCOXX-L

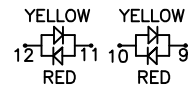

FOR P/N:E5J88-SXCOXX-L

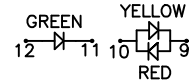

FOR P/N:E5J88-PXCOXX-L

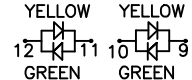

FOR P/N:E5J88-VXCOXX-L

PART NUMBER: E 5 J 8 8 - X X X X X X - L

- 1-LED1:GREEN ,LED2:YELLOW
- 2-LED1:GREEN ,LED2:GREEN
- 3-LED1:YELLOW ,LED2:GREEN
- 4-LED1:G+Y ,LED2:G+Y
- 5-LED1:RED ,LED2:GREEN
- 7-LED1:YELLOW ,LED2:YELLOW
- D-LED1:G+R ,LED2:G+R
- F-LED1:GREEN ,LED2:RED
- N-LED1:GREEN ,LED2:G+Y
- P-LED1:Y+R ,LED2:GREEN
- Q-LED1:G+Y ,LED2:G+R
- S-LED1:Y+R ,LED2:Y+R
- V-LED1:Y+G ,LED2:Y+G
- K-LED1:G+Y ,LED2:GREEN

- PLATING: 1-3u" 2-6u" 3-15u" 4-30u" 5-50u"
- 1- PLATE Tin SHIELD,STAMP PIN,LED LONG 7.00
- 2- PLATE Ni SHIELD,STAMP PIN,LED LONG 7.00
- 3- PLATE Tin SHIELD,ROUND PIN,LED LONG 7.00
- 4- PLATE Ni SHIELD,ROUND PIN,LED LONG 7.00
- 0-W/O LOGO
- 6-W/ FRE&UL
- 4-4 PORTS W/O MIDDLE POLE
- C-4 PORTS W/ MIDDLE POLE
- 0-NO SHIELD
- 1-NO TAB 2-TOP TABS.
- 3-SIDE TABS.
- 4-TOP TABS & SIDE TABS.

DETACHED LISTS	← MM (INCH) →		DFTO PETERS	DATE 03/24/05
	TOLERANCES EXCEPT AS NOTED		CHKD JAKE	DATE 2005/08/23
	MM	±	MFO	DATE
	.0 ± 0.20	±	APPV LUSHENG	DATE 2005/08/23
	.00 ± 0.15	±	MATERIAL :	
.000 ± 0.075	±	ANGLES ±		
THIRD ANGLE PROJECTION		FINISH :	QT'Y :	
		SCALE : 2:1	DO NOT SCALE DRAWING	SHEET 1 OF 1

FULL RISE ELECTRONIC CO., LTD			
TITLE			
RJ45 SIDE ENTRY LED GANG JACK 4 PORTS			
DRAWING NO. GE5J3017-LC		SIZE	REV
/PART NO. SEE NOTE		A3	2