

ECS-2532VXO offers a 2.8V and 3.3V version, subminiature SMD VCXO. Ideal for today's high density applications.

Request a Sample

OPERATING CONDITIONS / ELECTRICAL CHARACTERISTICS

ECS-2532VXO

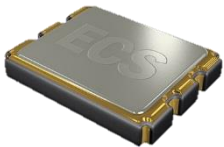

- Smallest VCXO in the Industry
- 3.2 x 2.5 mm Footprint
- Low current consumption
- PbFree/RoHS Compliant

Parameters	Conditions	ECS-2532VXO (+2.8V)			ECS-2532VXO (+3.3V)			Units
		MIN	TYP	MAX	MIN	TYP	MAX	
Frequency Range		2.000		54.000	2.000		54.000	MHz
Temperature Range	Operating	-10		+70	-10		+70	°C
	Storage	-40		+85	-40		+85	°C
Supply Voltage	VDD	+2.66	+2.8	+2.94	+3.135	+3.3	+3.465	VDC
Frequency Stability* V _{CO} = ½ VDD	Option A			±50			±50	PPM
	Option B			±30			±30	PPM
Frequency vs. Input Voltage	VDD ±5%			±5			±5	PPM
Frequency Pulling Range		±90			±90			PPM
Control Voltage	V _{CON} = Pin #1	0	+1.4	+2.8	0	+1.65	+3.3	VDC
Frequency Slope	Positive							
Frequency Linearity				15			15	%
Modulation Bandwidth	-3 dB	10			10			KHz
V _{CON} input impedance	V _{CON} - GND	100K			100K			Ω
Output Symmetry	@ 50% VDD Level			40/60			60/40	%
Rise and Fall Times 20% to 80% VDD Level	2.0 MHz to 10.0 MHz			10			10	ns
	10.1 MHz to 54.0 MHz			6			6	ns
"0" Level	VOL			10% V _{DD}			10% V _{DD}	VDC
"1" Level	VOH	90% V _{DD}			90% V _{DD}			VDC
Output Load	CMOS			15			15	pF
Start-Up Time				10			10	ms
Input Current	No Load			5			8	mA
SSB Phase Noise	at 1 KHz offset			-120			-120	dBc/Hz
Aging (first year)	at +25°C ±3°C			±5			±5	PPM

Part Numbering Guide: Example ECS-2532VXO-270B-2.8

ECS - Series - Frequency Abbreviations - Stability Tolerance - Voltage

ECS

2532VXO

200 = 20 MHz
270 = 27 MHz
540 = 54 MHz

A = ±50 ppm
B = ±30 ppm

2.8 = +2.8 VDC
3.3 = +3.3 VDC

Package Dimensions (mm)

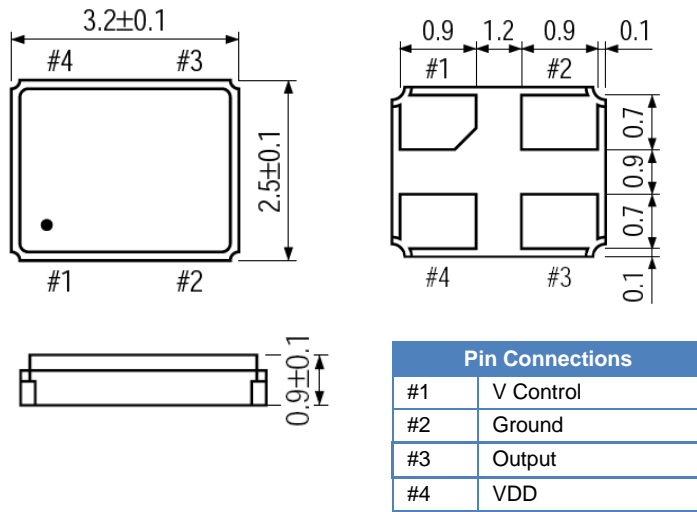

Figure 1) Top, Side, and Bottom views

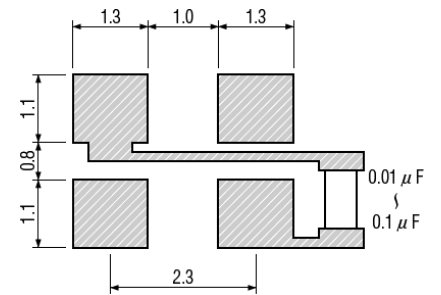

Figure 2) Land Pattern

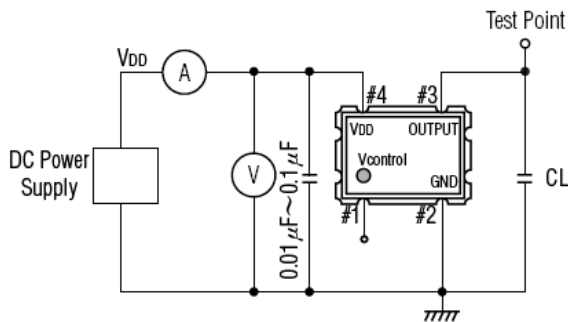

Figure 3) Test Circuit

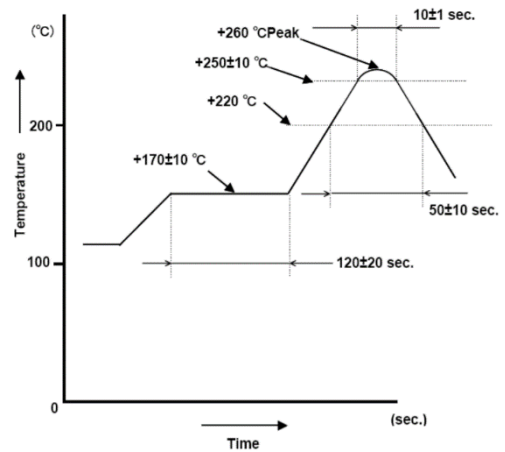
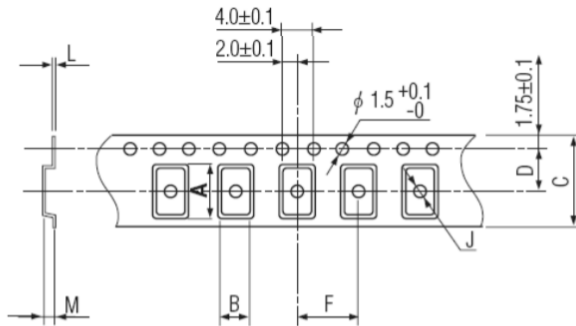

Figure 4) Suggested Reflow Profile

Tape Dimensions (mm)



A	B	C	D	F	J	L	M	Reel Dia.	Qty/Reel
3.5	2.8	8.0	3.5	4.0	1.1	0.25	1.0	180	1000

Figure 5) Pocket Tape Dimensions

Package Data	
Item	Description
Lid	Metal
Base	Ceramic
Sealing	Seam
Terminal	Tungsten (metalized)
Plating	Gold/Nickel (Surface)/(Under)
RoHS	Compliant (PbFree)