



Quality Products. Service Excellence.

Class 2 Energy Limiting Small Box Mount BA-C-D-E Series

Features



- Used in chimes, door bells, security systems, decorative lighting, furnaces, humidifiers, appliances, vending machines, intercom system type applications.
- Rugged, low noise, cool running design, indoor use only.
- Stripped wire input (primary) leads, screw terminal/quick fit tab terminal output (secondary).
- Nipple locknut mount for box installation, complete with locknut and mounting bracket (as shown below).
- Input leads are black, on 240V models 240V lead is red. All models are 60 Hz.- inherently limited - no fuses or circuit breakers.
- UL listed #E184371 - EXCEPT for part numbers BE2F & BE7G.
- CSA certified (209651)



Gallery

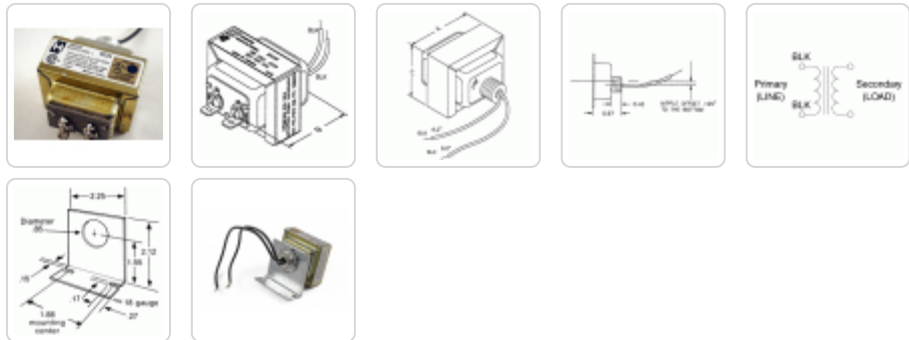

Accessories

- Mounting Bracket

Part No.	A.C. Input	A.C. Output		Power Rating	Note	Overall Dimensions		
	(Primary) V (RMS)	Secondary (RMS) V	A			A	B	C
BA2DA	120	10	0.5	5	*	2.33	2.22	1.98
BC2DA	120	10	1.2	12	*	2.33	2.22	1.98
BC2F	120	16	0.75	12	*	2.33	2.22	1.98
BC2G	120	24	0.5	12	*	2.33	2.22	1.98
BD2E	120	12	1.67	20	*	2.33	2.34	1.98
BD2EE	120	14	1.43	20	*	2.33	2.34	1.98
BD2F	120	16	1.25	20	*	2.33	2.34	1.98
BD2FF	120	18	1.11	20	*	2.33	2.34	1.98
BD2G	120	24	0.833	20	*	2.33	2.34	1.98
BE2F	120	16.5	2.42	40	*	2.33	2.60	1.98
BE2G	120	24	1.67	40	*	2.33	2.60	1.98
BD5F	240	16	1.25	20	*	2.33	2.34	1.98
BD5G	240	24	0.83	20	*	2.33	2.34	1.98
BE5G	240	24	1.67	40	*	2.33	2.60	1.98

Part No.	A.C. Input (Primary)	A.C. Output Secondary (RMS)		Power Rating		Overall Dimensions		
	V (RMS)	V	A	VA	Note	A	B	C
BE5DG	208/240	24	1.67	40	*	2.33	2.60	1.98
BE7G	347	24	1.67	40	-	2.33	2.60	1.98

Note: * = 105 degree temperature design

Data subject to change without notice

© 2021. Hammond Manufacturing Ltd. All rights reserved.