

PIN Diode SPDT 200 W Switch for High Power Applications

0.03 - 6.0 GHz



MASW-011120

Rev. V2

Features

- Broadband Performance
- Low Loss @ 2.7 GHz:
TX = 0.25 dB
RX = 0.35 dB
- High Isolation @ 2.7 GHz:
RX = 44 dB
- Power Handling @ 2.7 GHz:
200 W CW @ +85°C
122 W CW @ +120°C
- Lead-Free 5 mm 20-Lead HQFN Package
- RoHS* Compliant
- Designed for High Power TDD-LTE Applications

Description

The MASW-011120 is a SPDT high power, broadband, high linearity, PIN diode T/R switch for 0.03 - 6.0 GHz high power applications. The device is provided in an industry standard lead free 5 mm HQFN plastic package.

This device incorporates PIN diode die fabricated with a low loss, high isolation switching diode process.

MASW-011120 can be used in any application requiring a low-loss, high-isolation, and high-power-handling SPDT.

Ordering Information^{1,2}

Part Number	Package
MASW-011120-TR1000	1000 Piece Tape and Reel
MASW-011120-TR3000	3000 Piece Tape and Reel
MASW-011120-SMB	Sample Board

1. Reference Application Note M513 for reel size information.
2. All sample boards include 3 loose parts.

Functional Schematic

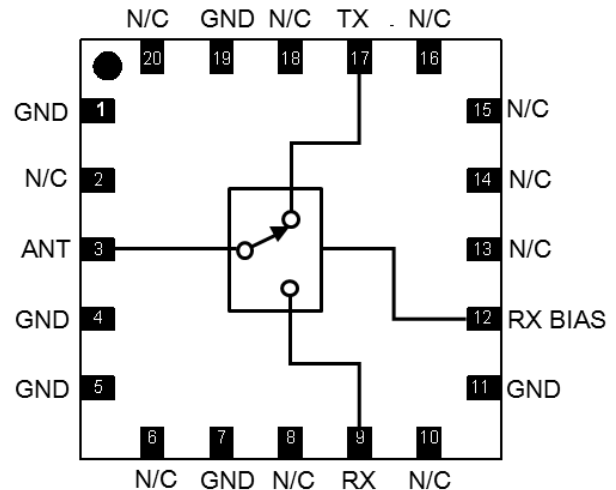

Pin Configuration³

Pin #	Pin Name	Function
1,4,5,7,11,19	GND	Ground
2,6,8,10,13,14,15,16,18,20	N/C	No Connection
3	ANT	RF Port
9	RX	RF Port
12	RX BIAS	RX Bias Input
17	TX	RF Port
21	Paddle	Ground ⁴

3. MACOM recommends connecting all No Connection (N/C) pins to ground.
4. The exposed pad centered on the package bottom must be connected to RF, DC and thermal ground.

* Restrictions on Hazardous Substances, compliant to current RoHS EU directive.

PIN Diode SPDT 200 W Switch for High Power Applications

0.03 - 6.0 GHz



MASW-011120

Rev. V2

Electrical Specifications:

Freq. = 2.7 GHz, 3.5 GHz, $T_A = +25^\circ\text{C}$, $Z_0 = 50 \Omega$, Bias = 60 V / 0 V. See Bias Table.

Parameter	Test Conditions	Units	Min.	Typ.	Max.
Insertion Loss	ANT to TX ON @ 2.7 GHz ANT to TX ON @ 3.5 GHz ANT to RX ON @ 2.7 GHz ANT to RX ON @ 3.5 GHz	dB	—	0.25 0.30 0.35 0.50	0.45 0.50 0.60 0.70
Isolation	ANT to RX (TX ON) @ 2.7 GHz ANT to RX (TX ON) @ 3.5 GHz ANT to TX (RX ON) @ 2.7 GHz ANT to TX (RX ON) @ 3.5 GHz	dB	35 35 12 10	44 44 15 13	—
ANT Return Loss	ANT to RX ON ANT to TX ON	dB	—	23 25	—
TX Return Loss	ANT to TX ON	dB	—	22	—
RX Return Loss	ANT to RX ON	dB	—	26	—
Input P0.1 dB ⁵	ANT to TX ON	dBm	—	51	—
IIP3 TX	ANT to TX, $P_{IN} = 30 \text{ dBm}$	dBm	—	68	—
IIP3 RX	ANT to RX, $P_{IN} = 30 \text{ dBm}$	dBm	—	68.5	—
RF Input Power CW ⁵ ANT to TX ON	85°C @ 2.7 GHz; 100 mA 85°C @ 2.7 GHz; 200 mA 120°C @ 2.7 GHz; 100 mA 120°C @ 2.7 GHz; 200 mA	W	—	145 200 97 122	—
Switching Speed TX T_{ON} TX T_{OFF} RX T_{ON} RX T_{OFF}	T_{ON} - 50% control to 90% RF T_{OFF} - 50% control to 10% RF	μs	—	0.5 1.6 0.3 0.3	—
Group Delay	—	ns	—	50	—
In-band Ripple	20 MHz 200 MHz	dB	—	0.05 0.1	—

5. Maximum source and load VSWR < 1.2:1.

Bias Table

Bias Table	TX	RX	RX BIAS	ANT
Pin	17	9	12	3
ANT to TX ON (Insertion Loss)	(GND), -100 mA ⁶	(+60 V), 10 mA ⁶	(GND), -10 mA ⁶	+5 V, 100 mA ⁶
ANT to RX (Isolation)	(GND), -100 mA ⁶	(+60 V), 10 mA ⁶	(GND), -10 mA ⁶	+5 V, 100 mA ⁶
ANT to RX ON (Insertion Loss)	(+60 V), 0 mA	(GND), -100 mA ⁶	(+60 V), 0 mA	+5 V, 100 mA ⁶
ANT to TX (Isolation)	(+60 V), 0 mA	(GND), -100 mA ⁶	(+60 V), 0 mA	+5 V, 100 mA ⁶

6. Currents level comply with the schematic on page 8.

2

MACOM Technology Solutions Inc. (MACOM) and its affiliates reserve the right to make changes to the product(s) or information contained herein without notice. Visit www.macom.com for additional data sheets and product information.

For further information and support please visit:
<https://www.macom.com/support>

DC-0020391

Maximum Operating Conditions⁷

Parameter	Operating Maximum
TX Forward Current	250 mA
RX Forward Current	250 mA
Reverse Voltage (RF & DC)	200 V
ANT to TX Power CW	See Power Derating Curve
ANT to TX Peak Power (LTE Signal)	1000 W
Junction Temperature ^{8, 9}	+175°C
Case (Paddle) Temperature	-40°C to +120°C
Storage Temperature	-55°C to +150°C

- 7. Exceeding these limits may cause permanent damage.
- 8. MACOM does not recommend sustained operation near these survivability limits.
- 9. Operating at nominal conditions with $T_J \leq +175^\circ\text{C}$ will ensure $\text{MTTF} > 1 \times 10^6$ hours.

Handling Procedures

Please observe the following precautions to avoid damage:

Static Sensitivity

These electronic devices are sensitive to electrostatic discharge (ESD) and can be damaged by static electricity. Proper ESD control techniques should be used when handling these devices.

Parameter	Rating	Standard
Human Body Model (HBM)	500 V (Class 1B)	ESDA / JEDEC JS-001
Charged Device Model (CDM)	2000 V (Class C7)	JEDEC JESD22-C101

Typical Performance Curves

ANT to TX Input Power Derating Curve @ 2.7 GHz

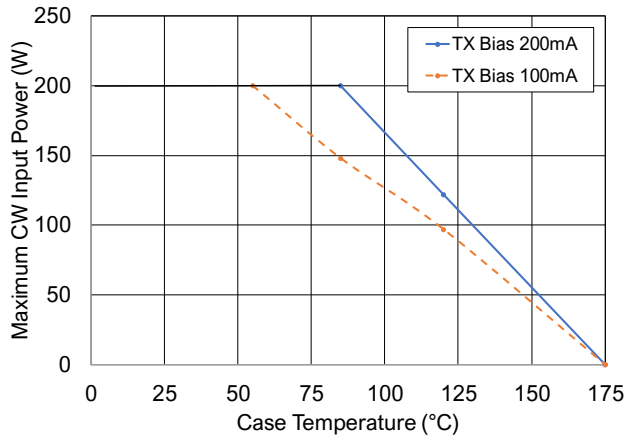

ANT to TX Input Power Derating Curve over Frequency @ 120°C Case Temp

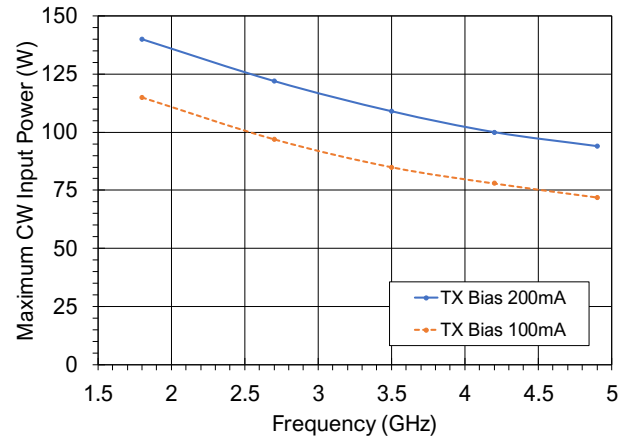

ANT to TX Input Power Derating Curve over Reverse Bias Voltage @ 2.7 GHz

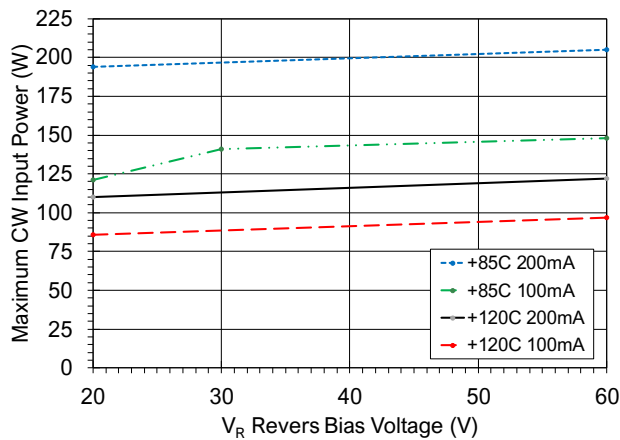

Typical Performance Curves over Temperature

All plots herein are taken with bias per the Bias Table on Page 2 unless otherwise specified.

S-parameters were measured using G-S-G probes on a sample board; reference planes are at the part's RF ports. The sample board and its layer stack-up are on page 7

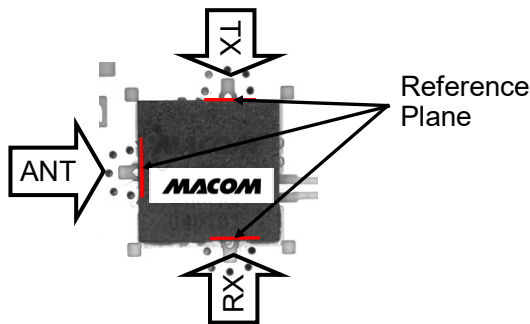

ANT to RX Insertion Loss

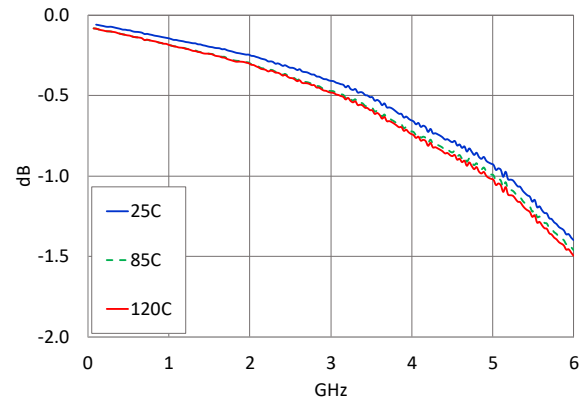

ANT to TX Insertion Loss

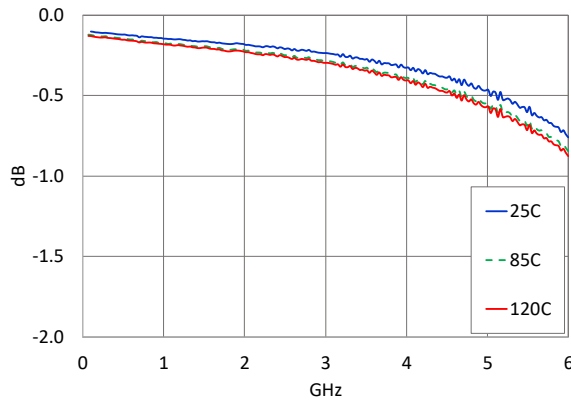

ANT Return Loss in RX ON state

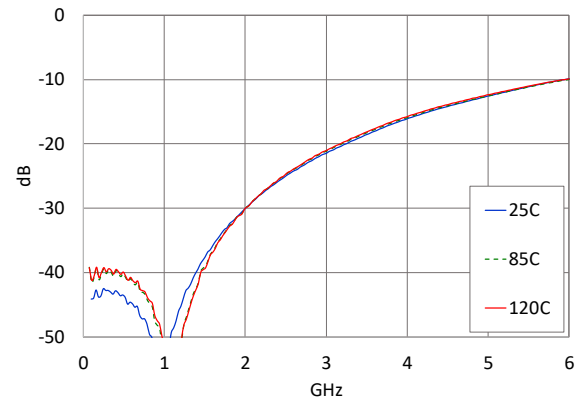

ANT Return Loss in TX ON state

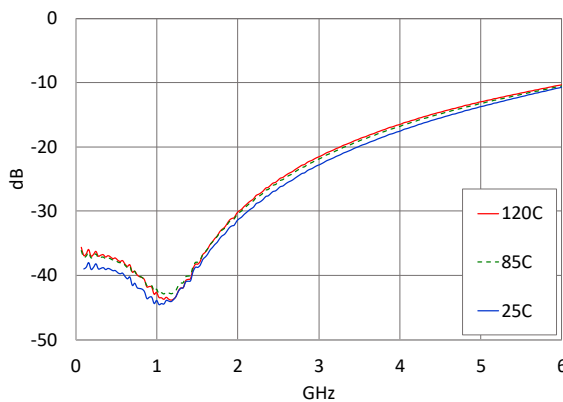

RX Return Loss in RX ON state

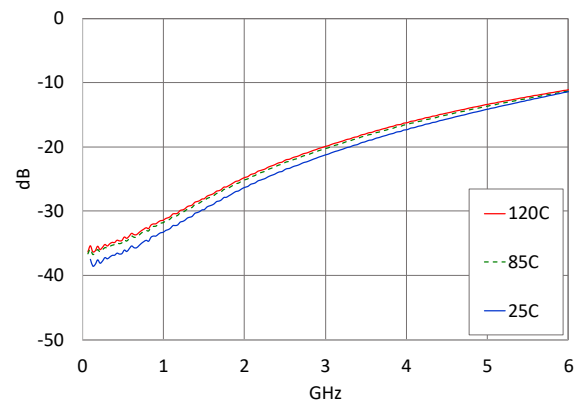

Typical Performance Curves over Temperature

TX Return Loss in TX ON state

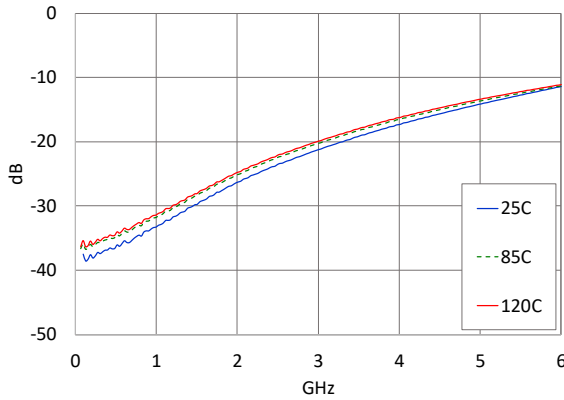

ANT to RX Isolation in TX ON state @ 100 mA

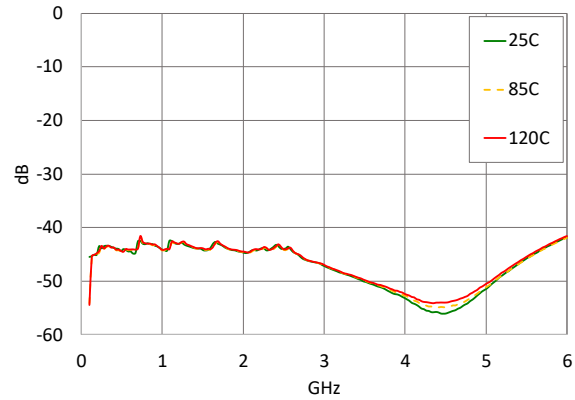

ANT to TX Isolation in RX ON state

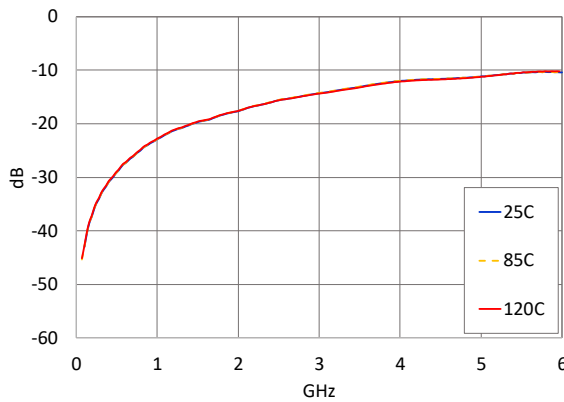

ANT to RX Isolation in TX ON state, over RX Bias Current @ 25°C

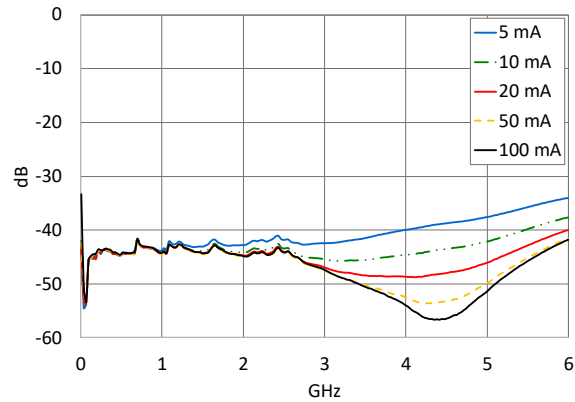

ANT to TX Insertion Loss over Current @ 25°C

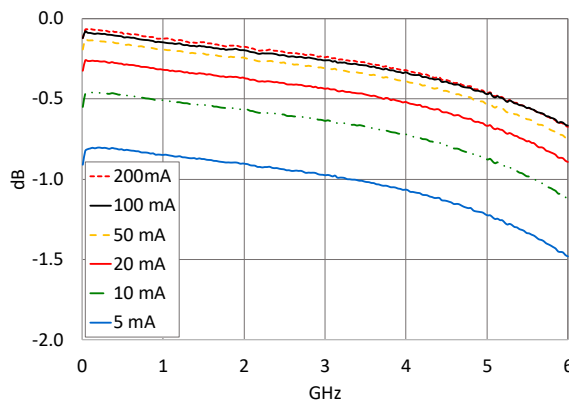

ANT to RX Insertion Loss over Current @ 25°C

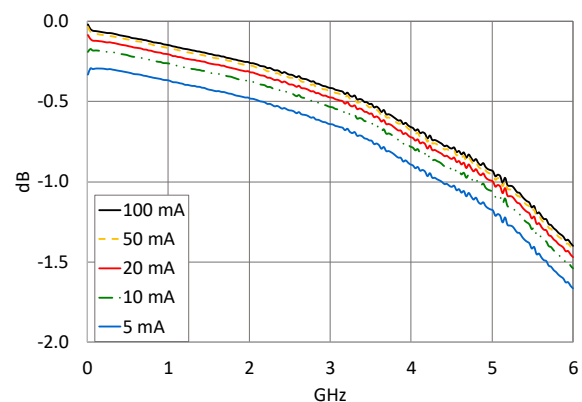

PIN Diode SPDT 200 W Switch for High Power Applications

0.03 - 6.0 GHz



MASW-011120

Rev. V2

Sample Board

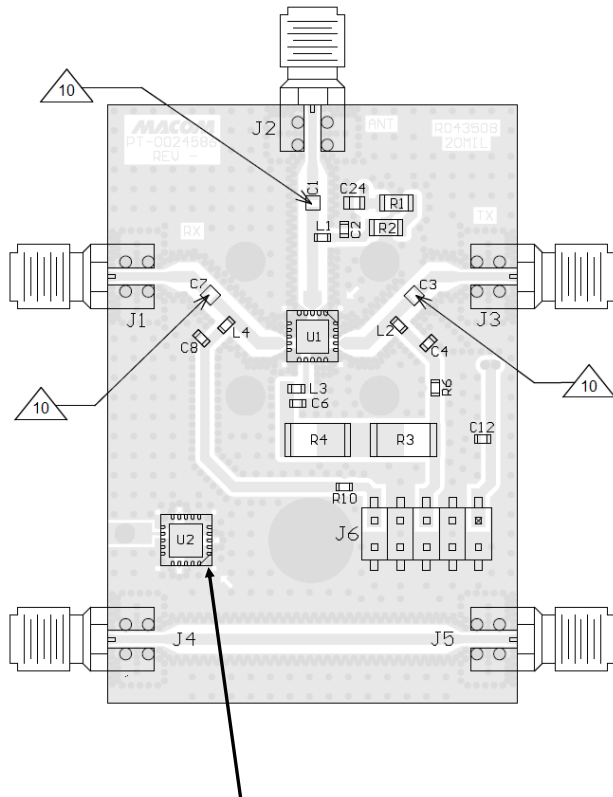

Optional part for probing, provided per request

PCB Layout Stack-Up

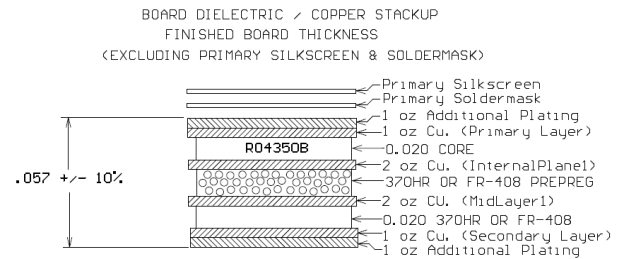

Dimensions are in inches.

To use the sample board: bias VCC at 5 V (current will be limited to 100 mA by on-board resistors R1, R2) and bias RX and TX according to the control table on page 8.

PIN Diode SPDT 200 W Switch for High Power Applications

0.03 - 6.0 GHz



MASW-011120

Rev. V2

Sample Board Schematic (parts list on page 9)

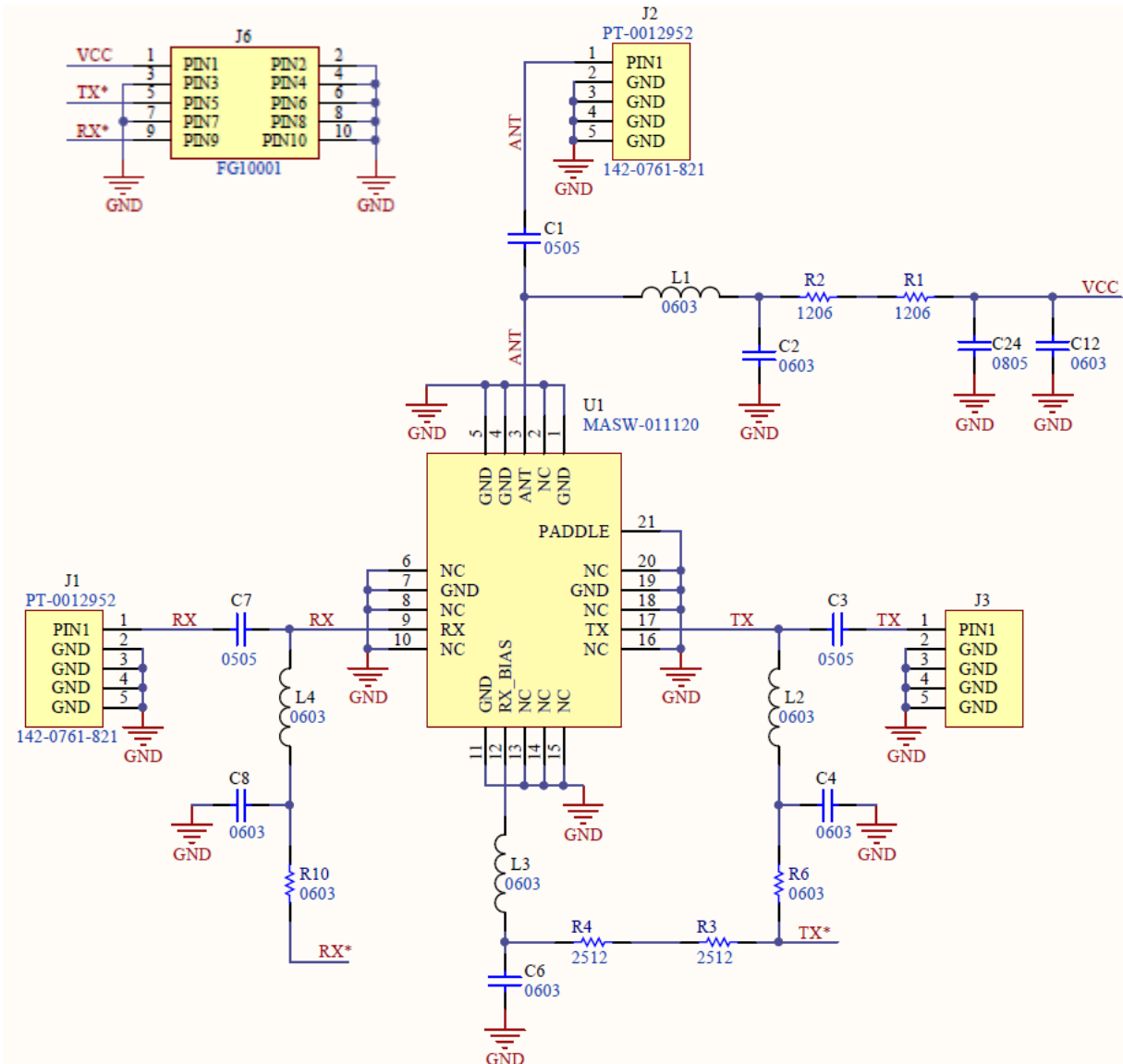

Control Table

Configuration	VCC	RX	TX/RX_Bias
TX ON RX OFF	5 V (100 mA)	60 V (10 mA)	GND
TX OFF RX ON	5 V (100 mA)	GND	60 V

PIN Diode SPDT 200 W Switch for High Power Applications

0.03 - 6.0 GHz



MASW-011120

Rev. V2

Parts List

Component ID	Value	Package	Mfg. Part#	Spec
U1	—	HQFN-20LD 5 mm	MASW-011120	—
L1, L2, L3, L4	33 nH	0603	LQW18AN33NJ8ZD	>200 mA
C1, C3, C7 ¹⁰	10 pF	0505	800A100JT250X	High Freq
C2, C4, C6, C8, C12	22 pF	0603	600S220FT250XT	High Freq
C24	1 μ F	0805	C2012X7S2A105K125AB	High Freq
R1, R2	20 Ω	1206	CRCW120620R0FKEA	0.25 W
R3, R4	2.37 k Ω	2512	CRCW25122K37FKEA	1.0 W
R6, R10	0 Ω	0603	—	—
J1-J5	RF CONN	SMA	142-0761-821	—
J6	DC CONN	10-pin	—	Surmount

10. Required vertical mounting orientation of C1, C3, & C7. Noted on PCB Layout on page 7.

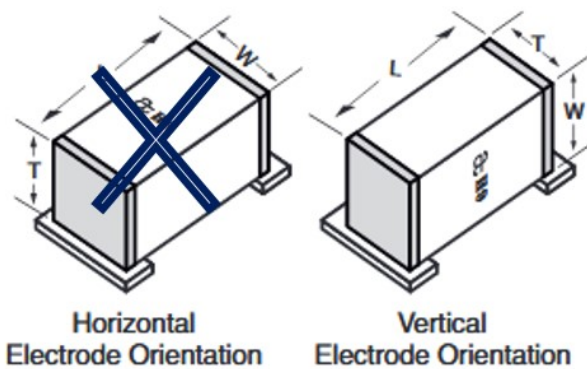

PIN Diode SPDT 200 W Switch for High Power Applications

0.03 - 6.0 GHz



MASW-011120

Rev. V2

Typical Performance Curves on the Sample Board over Temperature

ANT to TX Insertion Loss (PCB loss de-embedded)

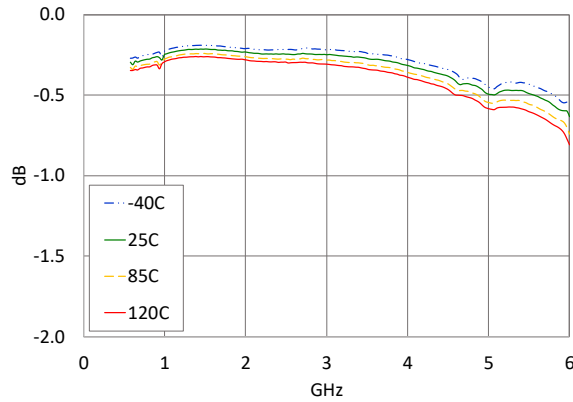

ANT to RX Insertion (PCB loss de-embedded)

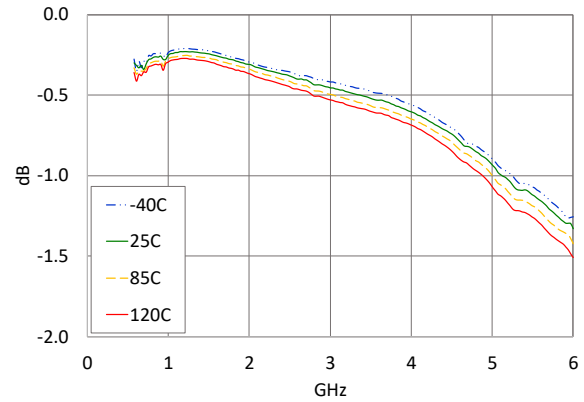

ANT Return Loss in TX ON state

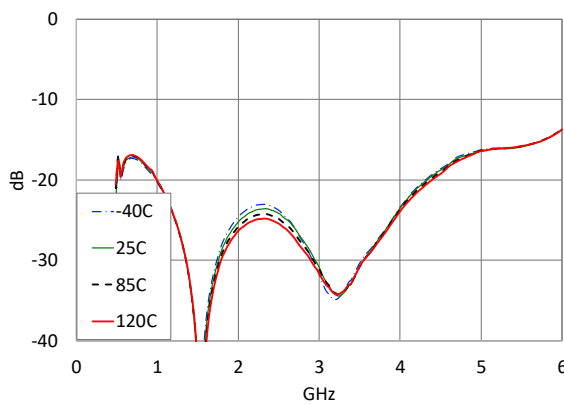

ANT Return Loss in RX ON state

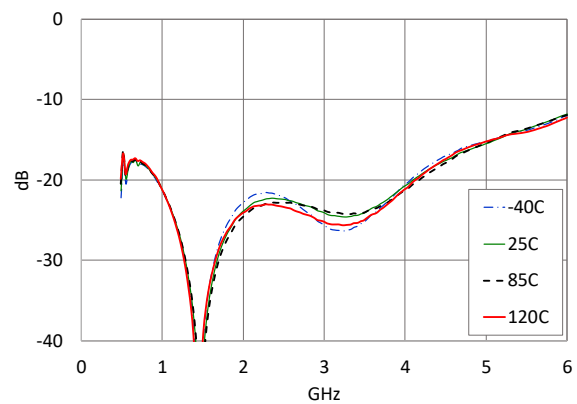

TX Return Loss in TX ON state

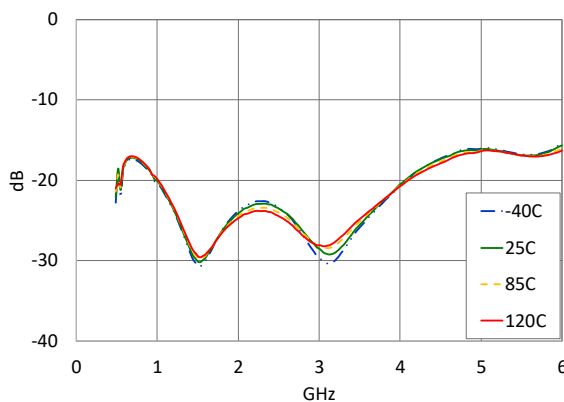

RX Return Loss in RX ON state

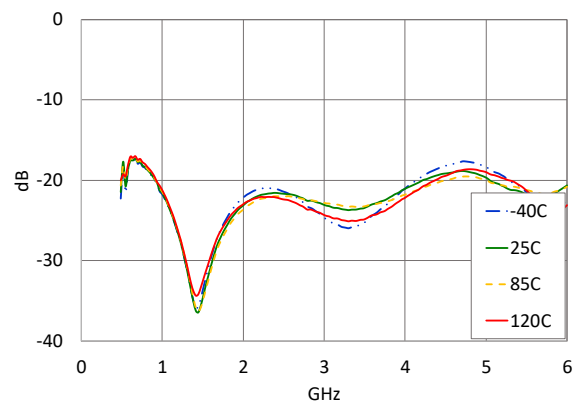

Typical Performance Curves on the Sample Board over Temperature

ANT to TX Insertion Loss over Current @ 25°C, PCB Loss De-embedded

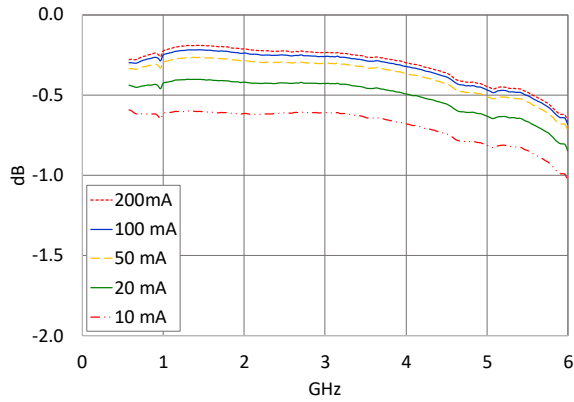

ANT to RX Insertion Loss over Current @ 25°C, PCB Loss De-embedded

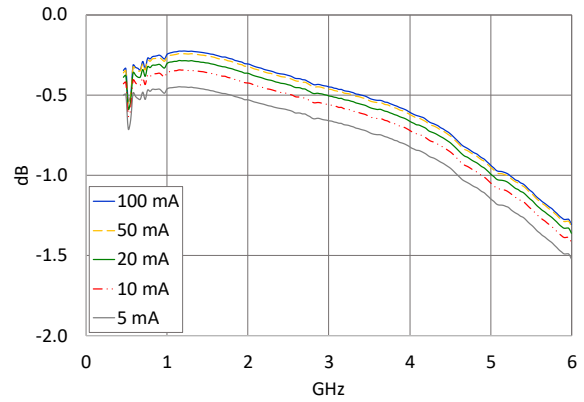

ANT to TX Isolation

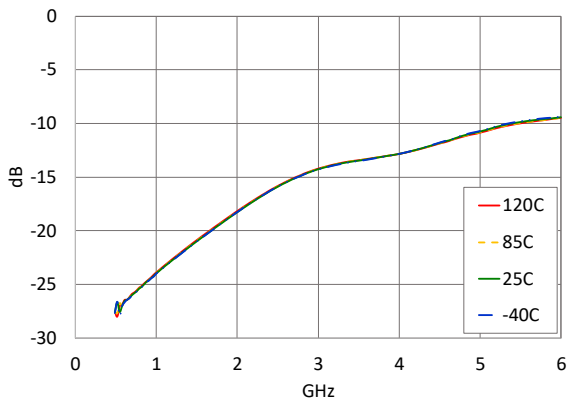

ANT to RX Isolation

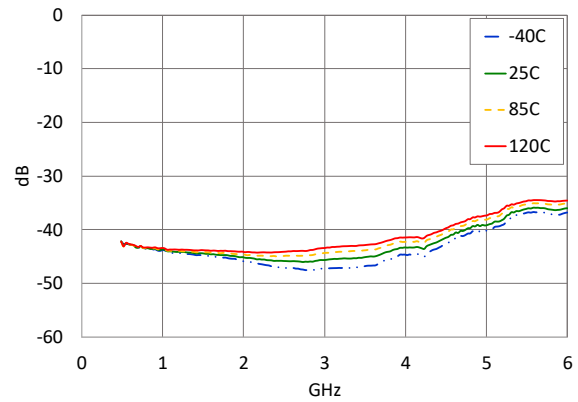

ANT to RX Isolation over Current @ 25°C

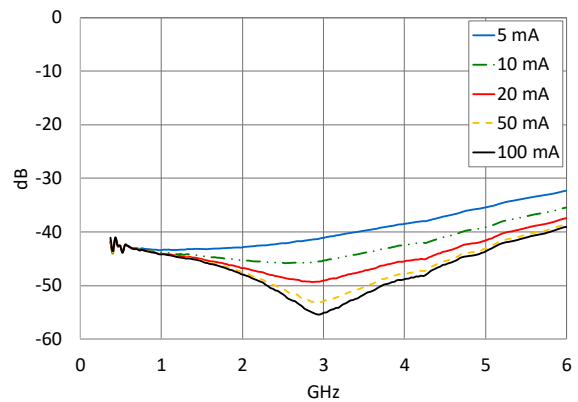

PIN Diode SPDT 200 W Switch for High Power Applications

0.03 - 6.0 GHz



MASW-011120

Rev. V2

Lead-Free 5 mm 20-Lead HQFN[†]

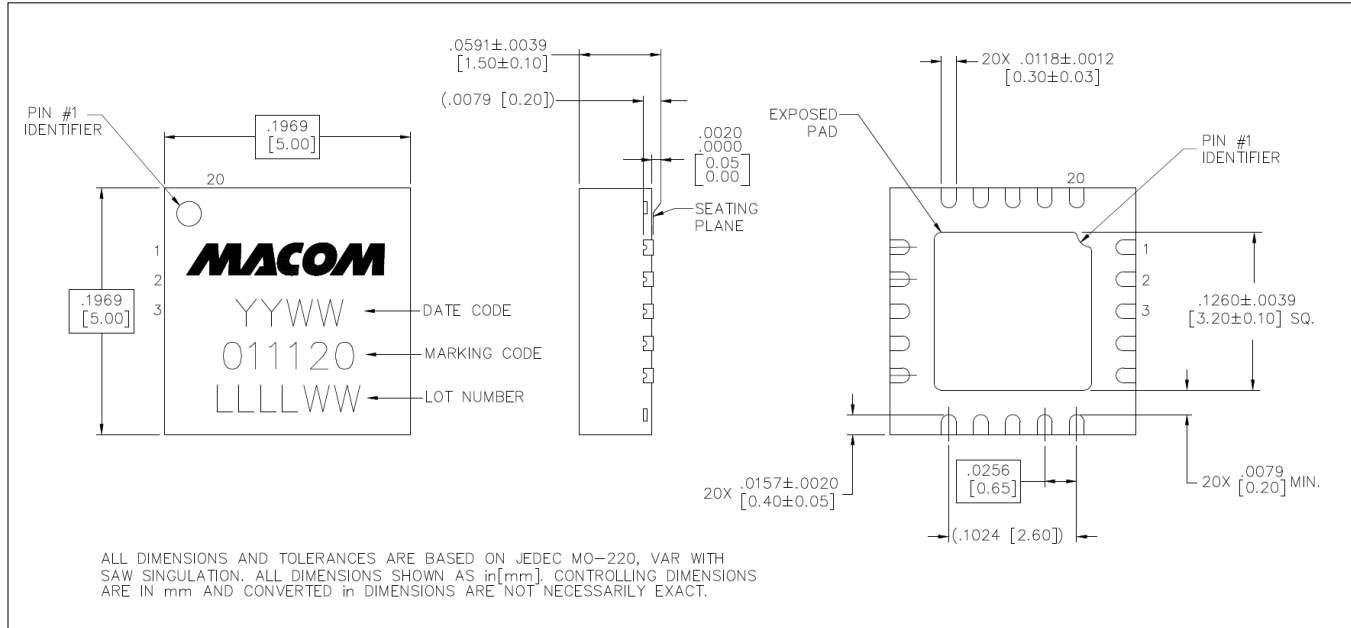

[†] Reference Application Note S2083 for lead-free solder reflow recommendations.
 Meets JEDEC moisture sensitivity MSL level 1 requirements.
 Plating is NiPdAuAg.

MACOM Technology Solutions Inc. ("MACOM"). All rights reserved.

These materials are provided in connection with MACOM's products as a service to its customers and may be used for informational purposes only. Except as provided in its Terms and Conditions of Sale or any separate agreement, MACOM assumes no liability or responsibility whatsoever, including for (i) errors or omissions in these materials; (ii) failure to update these materials; or (iii) conflicts or incompatibilities arising from future changes to specifications and product descriptions, which MACOM may make at any time, without notice. These materials grant no license, express or implied, to any intellectual property rights.

THESE MATERIALS ARE PROVIDED "AS IS" WITH NO WARRANTY OR LIABILITY, EXPRESS OR IMPLIED, RELATING TO SALE AND/OR USE OF MACOM PRODUCTS INCLUDING FITNESS FOR A PARTICULAR PURPOSE, MERCHANTABILITY, INFRINGEMENT OF INTELLECTUAL PROPERTY RIGHT, ACCURACY OR COMPLETENESS, OR SPECIAL, INDIRECT, INCIDENTAL, OR CONSEQUENTIAL DAMAGES WHICH MAY RESULT FROM USE OF THESE MATERIALS.

MACOM products are not intended for use in medical, lifesaving or life sustaining applications. MACOM customers using or selling MACOM products for use in such applications do so at their own risk and agree to fully indemnify MACOM for any damages resulting from such improper use or sale.