

SUMMARY



Image is for illustrative purpose only

Wires

Low voltage 3

Series 3S
Termination type Male solder
IP rating 50
AWG wire size 22.00 - 14.00
Cable Ø 4.30 - 5.70 mm
Status active
Matching parts [ERA.3S.303.CLL](#)

Download

[Request a quote](#)
[Catalog](#)

TECHNICAL DETAILS

Mechanics

Shell Style/Model FFA*: Straight plug, cable collet
Keying Hermaphroditic keying (half moon insert) with male pin 1
Housing Material Brass (chrome plated [SAE AMS 2460]) shell and collet nut, nickel plated [SAE AMS QQ N 290] brass latch sleeve and mid pieces
Weight 54.65 g

Performance

Configuration 3S.303 : 3 Low Voltage
Insulator L: PEEK (UL 94 / V-0/1.5)
Rated Current 20 Amps

Specifications

Contact Type: Solder
Vtest: 1500 V (AC), 2100 V (DC)

Others

Endurance (Shell): 5000 mating cycles
Temp (min / max): -55° C / +250° C
Humidity (max): <=95% [at 60 deg C / 140 F]

LEMO products and services are provided "as is". LEMO makes no warranties or representations with regard to LEMO product & services or use of them, express, implied or statutory, including for accuracy, completeness, or security. The user is fully responsible for his products and applications using LEMO components.

Vibration: 15 g [10 Hz - 2000 Hz]
 Shock Resistance: 100 g [6 ms]
 Climatical Category: 50/175/21
 Shielding (min): 75 dB (10 MHz)
 Shielding (min): 40 dB (1 GHz)
 Salt Spray Corrosion: >144 hr

DRAWINGS

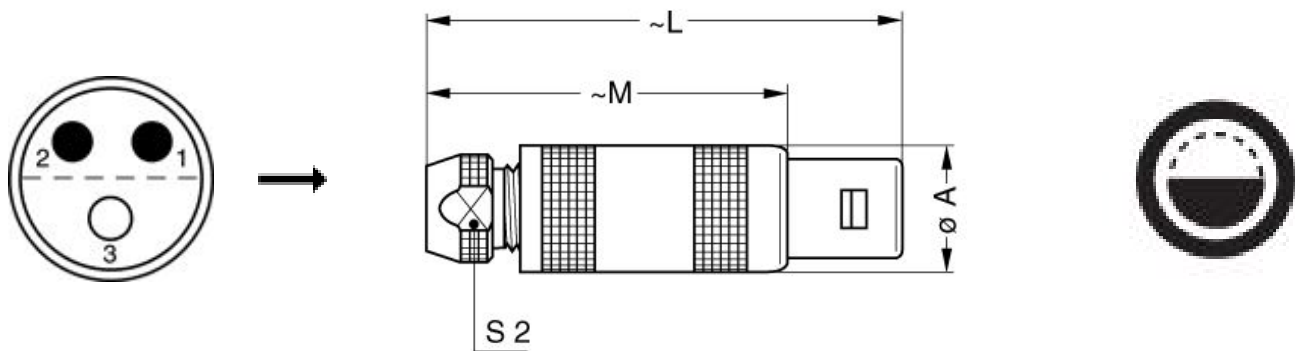

Dimensions

	A	L	M	S2
mm.	17.8	61	46	14
in.	0,70	2,40	1,81	0,55

RECOMMENDED BY LEMO









Tools

Spanner wrench: [DCP.91.023.TN](#)

Cables

CMN.03.T18.055PGZE		Grey	
CMN.03.T18.055PNZE			

LEMO products and services are provided "as is". LEMO makes no warranties or representations with regard to LEMO product & services or use of them, express, implied or statutory, including for accuracy, completeness, or security. The user is fully responsible for his products and applications using LEMO components.

CMN.03.T18.055QGZE	TPR (medical)	Grey	
CMN.03.T20.049PGZE		Grey	
CMN.03.T20.049PNZE			
130240	PVC	Black	
130250	PVC	Grey	
230500	PVC	Grey	
30260	PVC	Black	
3220	PVC	Black	
60080	PVC	Grey	

LEMO products and services are provided "as is". LEMO makes no warranties or representations with regard to LEMO product & services or use of them, express, implied or statutory, including for accuracy, completeness, or security. The user is fully responsible for his products and applications using LEMO components.