

NPN Silicon Phototransistor

OP508F, OP509 Series



Features:

- Flat lensed for wide acceptance angle (OP508F)
- Lensed for high sensitivity (OP509)
- Easily stackable on 0.100" (2.54 mm) hole centers
- Inexpensive plastic package
- Mechanically and spectrally matched to OP168 and OP268 series of infrared emitting diodes

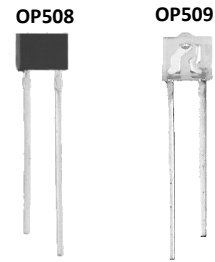

Description:

Each device in the **OP508F** series consists of a NPN silicon phototransistor mounted in a flat, black plastic “end-looking” package. The flat sensing surface allows an acceptance half-angle of 60° when measured from the optical axis to the half power point.

Each device in the **OP509** series consists of a NPN silicon phototransistor mounted in a lensed, clear plastic “end-looking” package. The lensing effect of the package allows an acceptance half-angle of 25° when measured from the optical axis to the half power point.

OP508F and **OP509** series devices can be mounted on 0.100" (2.54 mm) hole centers, which makes them an ideal low-cost alternate to hermetic OP600 sensors. *OP508F and OP509 series devices are mechanically and spectrally matched to the OP168F and OP268F series of infrared emitting diodes.*

Please refer to Application Bulletins 208 and 210 for additional design information and reliability (degradation) data.

For custom versions of the **OP508F**, **OP509** and **OP538F** series devices please contact your OPTEK representative.

Applications:

- Applications requiring a wide acceptance angle
- Applications requiring high sensitivity
- Space-limited applications

Ordering Information			
Part Number	Sensor	Viewing Angle	Lead Length
OP508FA	Phototransistor	120°	0.50"
OP508FC			
OP509A		50°	
OP509B			
OP509C			



RoHS

General Note
TT Electronics reserves the right to make changes in product specification without notice or liability. All information is subject to TT Electronics' own data and is considered accurate at time of going to print.

TT Electronics | OPTEK Technology
2900 E. Plano Pkwy, Plano, TX 75074 | Ph: +1 972 323 2200
www.ttelectronics.com | sensors@ttelectronics.com

NPN Silicon Phototransistor

OP508F, OP509 Series



OP508F (A, C)

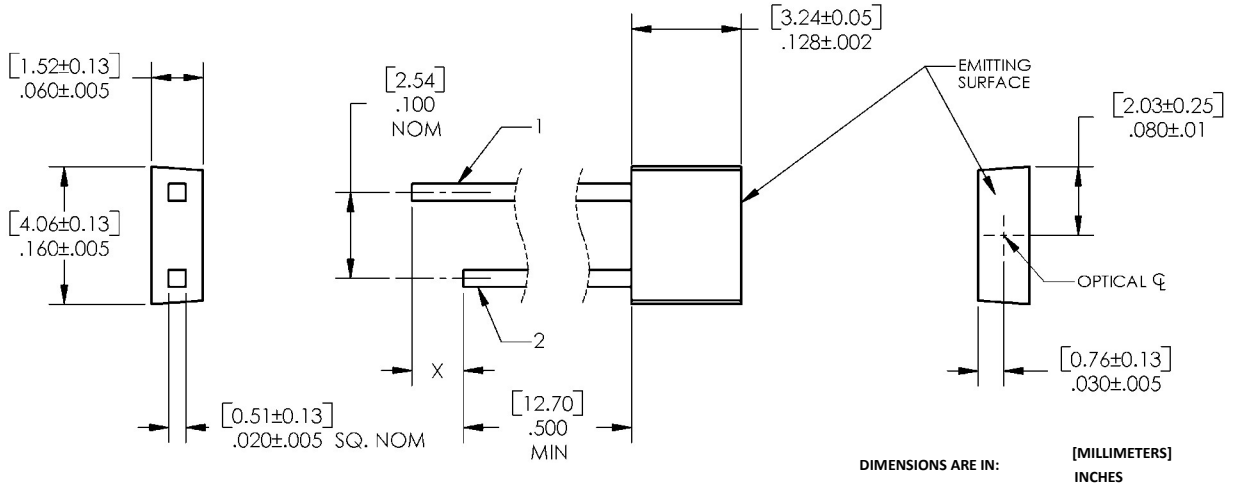

OP509 (A, B)

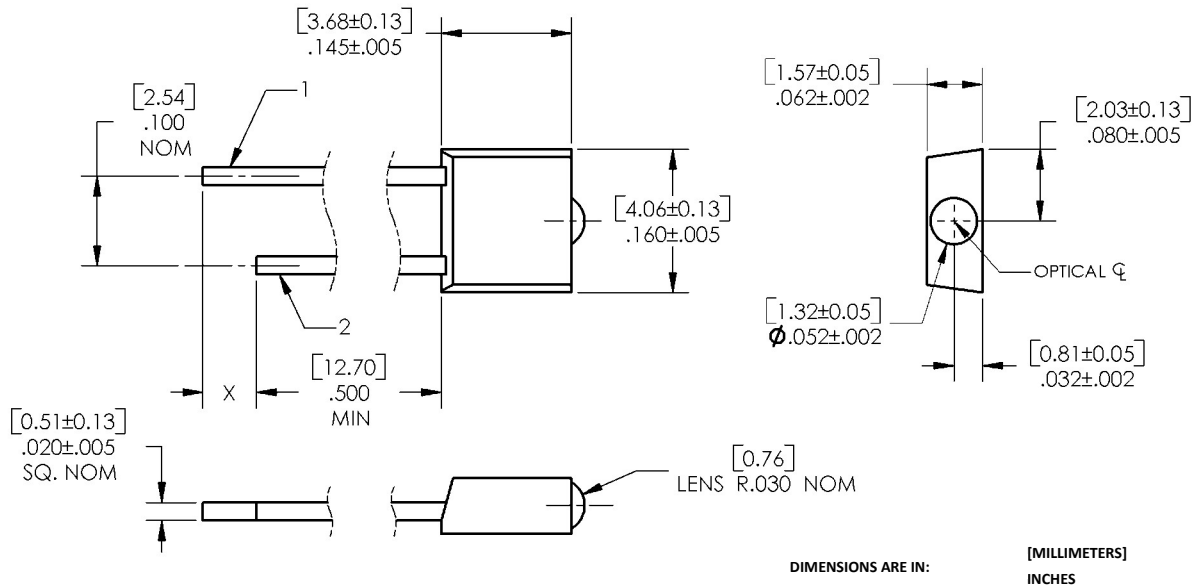

OP508F & OP509

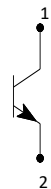

OP538

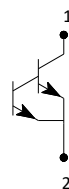

Pin #	Transistor
1	Collector
2	Emitter

General Note

TT Electronics reserves the right to make changes in product specification without notice or liability. All information is subject to TT Electronics' own data and is considered accurate at time of going to print.

TT Electronics | OPTEK Technology
 2900 E. Plano Pkwy, Plano, TX 75074 | Ph: +1 972 323 2200
www.ttelectronics.com | sensors@ttelectronics.com

NPN Silicon Phototransistor

OP508F, OP509 Series



Electrical Specifications

Absolute Maximum Ratings ($T_A = 25^\circ\text{C}$ unless otherwise noted)	
Storage and Operating Temperature Range	-40°C to $+100^\circ\text{C}$
Collector-Emitter Voltage	30 V
Emitter-Collector Voltage	5 V
Lead Soldering Temperature [1/16 inch (1.6 mm) from case for 5 seconds with soldering iron]	$260^\circ\text{C}^{(1)}$
Power Dissipation	$100\text{ mW}^{(2)}$

Electrical Characteristics ($T_A = 25^\circ\text{C}$ unless otherwise noted)						
SYMBOL	PARAMETER	MIN	TYP	MAX	UNITS	TEST CONDITIONS
$I_{C(ON)}$	On-State Collector Current			20.00		$V_{CE} = 5.0\text{ V}, E_E = 5\text{ mW/cm}^2^{(3)}$
	OP509A (Dome Lens)	5.70	-	-		
	OP508FA (Flat Lens)	2.70	-	10.60	mA	
	OP509B (Dome Lens)	1.40	-	-		
	OP508FC (Flat Lens)	0.34	-	-		
$I_C/\Delta T$	Relative I_C Change with Temperature	-	1.00	-	%/ $^\circ\text{C}$	$V_{CE} = 5\text{ V}, E_E = 1.0\text{ mW/cm}^2^{(3)}, \lambda = 890\text{ nm}$
I_{CEO}	Collector-Dark Current			100		$V_{CE} = 10.0\text{ V}, E_E = 0^{(4)}$
	OP508F & OP509	-	-	225	nA	
	OP538F	-	-	-		
$V_{(BR)CEO}$	Collector-Emitter Breakdown Voltage					$I_C = 1.00\text{ mA}, E_E = 0$
	OP508F & OP509	30	-	-	V	
$V_{(BR)ECO}$	Emitter-Collector Breakdown Voltage	5	-	-	V	$I_E = 100\ \mu\text{A}$
$V_{CE(SAT)}$	Collector-Emitter Saturation Voltage					$I_C = 300\ \mu\text{A}, E_E = 5\text{ mW/cm}^2^{(3)}$
	OP508F	-	-	0.4	V	
	OP509	-	-	0.4	V	

Notes:

- RMA flux is recommended. Duration can be extended to 10 seconds maximum when flow soldering. A maximum 20 grams force may be applied to the leads when soldering.
- Derate linearly $1.33\text{ mW}/^\circ\text{C}$ above 25°C .
- Light source is an unfiltered GaAs or GaAlAs LED with a peak emission wavelength of 935 or 890 nm and a radiometric intensity level which varies less than 10% over the entire lens surface of the phototransistor being tested.
- To calculate typical collector dark current in μA , use the formula $I_{CEO} = 10^{(0.040 T_A - 3.4)}$, where T_A is ambient temperature in $^\circ\text{C}$.

General Note

TT Electronics reserves the right to make changes in product specification without notice or liability. All information is subject to TT Electronics' own data and is considered accurate at time of going to print.

TT Electronics | OPTeK Technology
2900 E. Plano Pkwy, Plano, TX 75074 | Ph: +1 972 323 2200
www.ttelectronics.com | sensors@ttelectronics.com

NPN Silicon Phototransistor

OP508F, OP509 Series



Performance

OP508FA, OP508FC, OP508FD

Typical Spectral Response

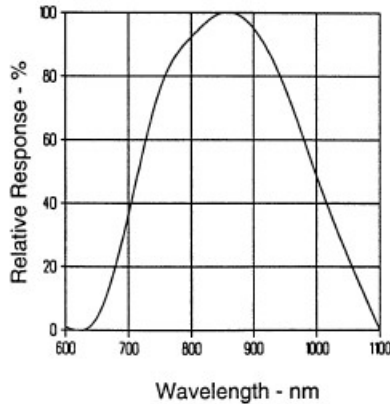

Coupling Characteristics of OP168F and OP508F

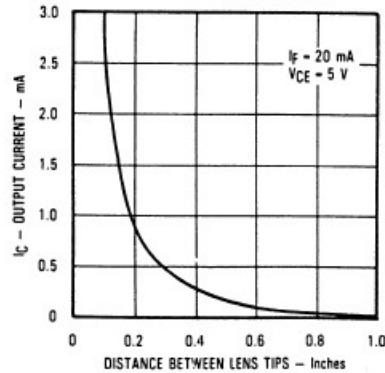

Normalized Collector Current vs. Angular Displacement

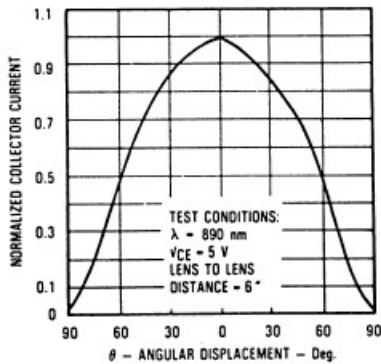

On-State Collector Current vs. Irradiance

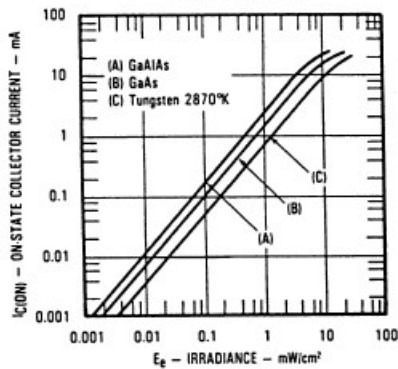

Normalized Collector Current vs. Collector to Emitter Voltage

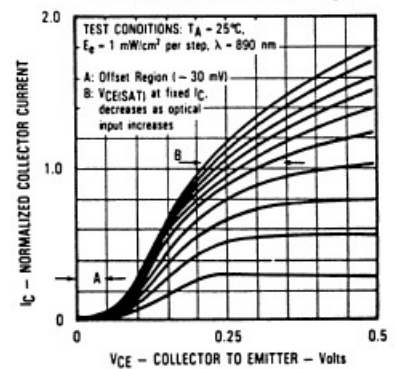

Rise and Fall Time vs Load Resistance

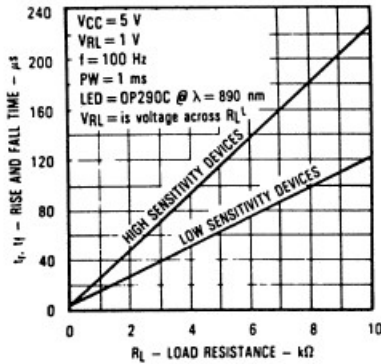

Normalized Output vs. Frequency

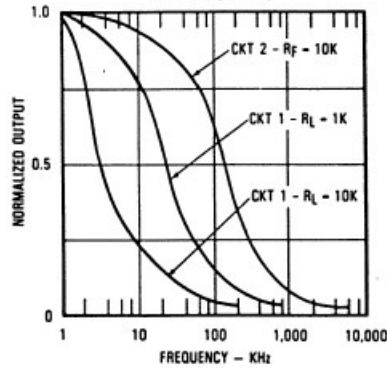

Switching Time Test Circuit

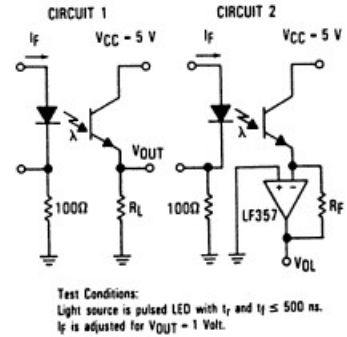

General Note

TT Electronics reserves the right to make changes in product specification without notice or liability. All information is subject to TT Electronics' own data and is considered accurate at time of going to print.

TT Electronics | OPTEK Technology
2900 E. Plano Pkwy, Plano, TX 75074 | Ph: +1 972 323 2200
www.ttelectronics.com | sensors@ttelectronics.com

NPN Silicon Phototransistor

OP508F, OP509 Series



Performance

OP509A, OP509B, OP509D

Typical Spectral Response

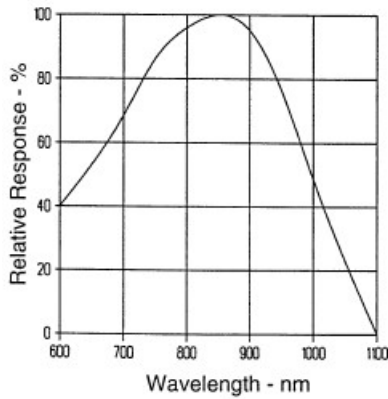

Coupling Characteristics of OP169 and OP509

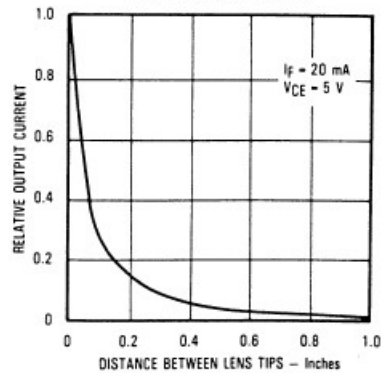

Normalized Collector Current vs. Angular Displacement

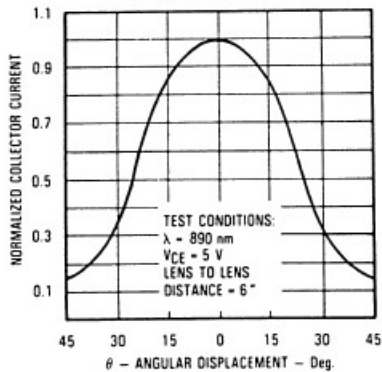

On-State Collector Current vs. Irradiance

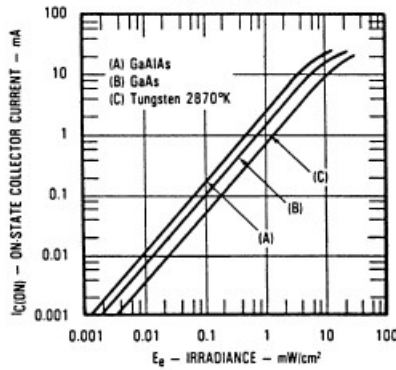

Normalized Collector Current vs. Collector to Emitter Voltage

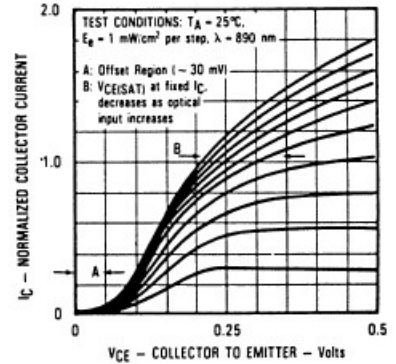

Rise and Fall Time vs Load Resistance

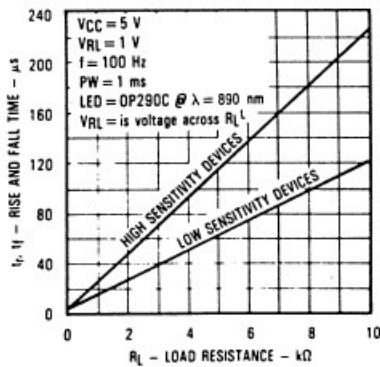

Normalized Output vs. Frequency

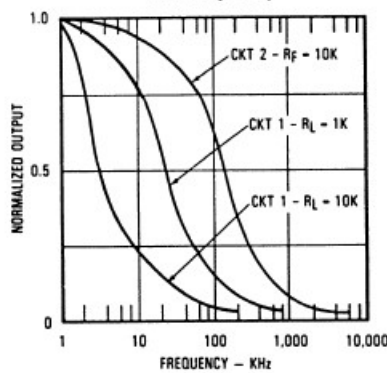

Switching Time Test Circuit

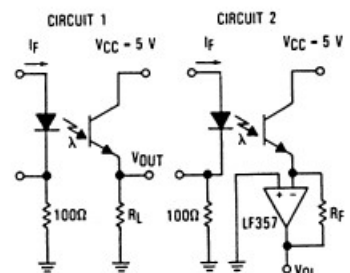

Test Conditions:
Light source is pulsed LED with t_r and $t_f \leq 500$ ns.
 I_f is adjusted for $V_{OUT} = 1$ Volt.

General Note

TT Electronics reserves the right to make changes in product specification without notice or liability. All information is subject to TT Electronics' own data and is considered accurate at time of going to print.