

## Specification

**PATENT PENDING**

- Part No. : **MA1130.A.LBICGT.002**
- Product Name : Raptor II - 6 in 1 Next Generation Dual Fin Permanent Mount External Antenna with GPS/GLONASS/Galileo/BeiDou, LTE MIMO 1&2, Wi-Fi MIMO 1&2 and AM/FM
- Feature :
- 2 x 4G/3G/2G MIMO Antenna
    - (698~960MHz, 1710~2170MHz, 2300~2700MHz)
  - 1 x GPS/GLONASS/Galileo/BeiDou Antenna
    - (1561/1575.42/1602MHz)
  - 2 x Wi-Fi 2.4GHz/5.8GHz MIMO Antenna
    - MIMO2 antenna can be replaced by C-V2X/DSRC band
  - 1 x AM/FM Antenna
- IP67 Waterproof  
Front End SAW Filter  
High Efficiency/Peak Gain Outdoor Antenna  
SMA(M) and RP-SMA(M) Connectors as standard (Fakra Optional)  
0.3m RG-174 Cable as standard  
**RoHS & REACH Compliant**



## 1. Introduction

The Raptor II MA1130 is a 6in1 next generation, dual fin, permanent screw mount antenna for vehicle roof applications. It is fully IP67 waterproof with a distinct quality dual fin high gloss finish housing that has passed highest automotive hardness testing levels to help prevent scratching. The 6 separate antennas inside support frequency bands in LTE, GPS/GLONASS/Galileo/BeiDou, Wi-Fi, 4G/3G/2G and AM/FM radio.

This outstanding, patent pending, antenna delivers powerful MIMO antenna technology for 4G LTE, Wi-Fi 2.4/5.8GHz 802.11n and the emerging 802.11ac, plus a high gain omnidirectional C-V2X (DSRC) 5.9GHz antenna, and an optimized GPS/GLONASS/Galileo/BeiDou patch antenna for location.

The 4G LTE antennas also include backward compatibility to work at most worldwide 3G and 2G bands.

Applications include:

- Next generation OEM car connectivity
- Multimedia, navigation and telematics systems
- V2V and C-V2X applications
- Fleet management
- Real-time HD video streaming
- E-Call

Examples of new uses that require such a highly sophisticated antenna are real-time streaming applications that demand high speed video uplink and downlink into the cabin of the car. These challenges are resolved by the highly efficient, high gain MIMO antennas, with high isolation, which is necessary to achieve the required signal to noise ratio and throughput.

The Raptor II can also be customized for your particular wireless application and frequency band, subject to NRE and MOQ.



The six standard cables are 300mm RG-174, terminating in SMA(M) for GNSS, LTE MIMO 1&2, AM/FM, C-V2X/DSRC and RP SMA(M) for Wi-Fi.

Cable length and connector types are customizable. For short cable runs up to 1 meter, RG-174 Low Loss can be used. For longer cable runs it is recommended to use low loss TGC-200 cable extensions. Contact your regional Taoglas customer support team for more information.

## 2. Specification Table

4G/3G/2G MIMO							
Band	LTE 700	GSM 850	GSM 900	DCS	PCS	UMTS1	LTE 2600
Frequency (MHz)	698-824	824-894	880-960	1710-1880	1850-1990	1920-2170	2500-2690
MIMO 1							
Peak Gain (dBi) *	1.61	0.64	-0.23	4.00	3.54	3.40	5.69
Average Gain (dBi)*	-5.34	-4.49	-6.04	-3.88	-3.37	-3.57	-3.51
Efficiency (%)*	29.82	35.55	25.57	41.12	45.98	43.97	44.80
Return loss (dB) *	<-6	<-6	<-4	<-5	<-10	<-10	<-8
MIMO 2							
Peak Gain (dBi) *	0.26	1.44	0.53	3.74	3.98	4.08	6.12
Average Gain (dBi) *	-5.36	-4.21	-5.15	-4.18	-3.48	-3.59	-3.30
Efficiency (%) *	29.59	38.02	30.91	38.35	44.87	43.83	46.83
Return loss (dB) *	<-6	<-6	<-4	<-5	<-10	<-10	<-8
Polarization	Linear						
Impedance	50Ω						
Cable	300mm RG-174 standard, fully customizable						
Connector	SMA Male Straight, fully customizable						

2.4GHz/5.8GHz MIMO		
Frequency (GHz)	2.4~2.5	5.15~5.85
MIMO 1		
Peak Gain (dBi) *	3.43	2.92
Average Gain (dBi) *	-4.38	-4.23
Efficiency (%)*	36.57	37.75
Return loss (dB) *	<-10	<-6
MIMO 2		
Peak Gain (dBi) *	6.81	6.37
Average Gain (dBi) *	-2.86	-3.65
Efficiency (%)*	52.66	44.19
Return loss (dB) *	<-10	<-6
Polarization	Linear	
Impedance	50Ω	
Cable	300mm RG-174 standard, fully customizable	
Connector	SMA Male RP Straight, fully customizable	

C-V2X/DSRC	
Frequency (GHz)	5.850~5.925
Peak Gain (dBi) *	6.6
Average Gain (dBi) *	-3.81
Efficiency (%)*	41.69
Return loss (dB) *	<-10
Polarization	Linear
Impedance	50Ω
Cable	300mm RG174 standard, fully customizable
Connector	SMA Male Straight, fully customizable

GPS/GLONASS/GALILEO/BeiDou			
Center Frequency fc	BeiDou:1561.098 ± 2MH	GPS:1575.42±3 MHz	GLONASS:1602±0.5 MHz
Gain	-1 dBi typ.	-2.5 dBi typ.	-1.5 dBi typ.
VSWR(@Center Frequency)	< 2		
Polarization	RHCP		
Impedance	50Ω		
Antenna size	25*25*4mm		
Cable	300mm RG-174 standard, fully customizable		
Connector	SMA Male Straight, fully customizable		
LNA Electrical Properties			
Frequency	1558~1610MHz		
Gain @3V	28 dB typical		
DC Power Input	3V		
Noise Figure @3V	2.8dB		
Power Consumption @3V	10 mA		

MECHANICAL	
Antenna Dimensions	176.2*84.5*70.8mm (L*W*H)
Housing	PC
Waterproof	IP67
Base	Aluminum
Thread diameter	M20 x 1.5P
Nut	Nickel Plated Steel
ENVIRONMENTAL	
Operation Temperature	-40°C to 85°C
Storage Temperature	-40°C to 90°C
Humidity	Non-condensing 65°C 95% RH

\* All measurements were conducted with 300mm cable length

LTE BANDS				
Band Number	LTE / LTE-Advanced / WCDMA / HSPA / HSPA+ / TD-SCDMA			
	Uplink	Downlink	MIMO 1	MIMO 2
1	UL: 1920 to 1980	DL: 2110 to 2170	✓	✓
2	UL: 1850 to 1910	DL: 1930 to 1990	✓	✓
3	UL: 1710 to 1785	DL: 1805 to 1880	✓	✓
4	UL: 1710 to 1755	DL: 2110 to 2155	✓	✓
5	UL: 824 to 849	DL: 869 to 894	✓	✓
7	UL: 2500 to 2570	DL: 2620 to 2690	✓	✓
8	UL: 880 to 915	DL: 925 to 960	✓	✓
9	UL: 1749.9 to 1784.9	DL: 1844.9 to 1879.9	✓	✓
11	UL: 1427.9 to 1447.9	DL: 1475.9 to 1495.9	✗	✗
12	UL: 699 to 716	DL: 729 to 746	✓	✓
13	UL: 777 to 787	DL: 746 to 756	✓	✓
14	UL: 788 to 798	DL: 758 to 768	✓	✓
17	UL: 704 to 716	DL: 734 to 746	✓	✓
18	UL: 815 to 830	DL: 860 to 875	✓	✓
19	UL: 830 to 845	DL: 875 to 890	✓	✓
20	UL: 832 to 862	DL: 791 to 821	✓	✓
21	UL: 1447.9 to 1462.9	DL: 1495.9 to 1510.9	✗	✗
22	UL: 3410 to 3490	DL: 3510 to 3590	✗	✗
23	UL: 2000 to 2020	DL: 2180 to 2200	✓	✓
24	UL: 1625.5 to 1660.5	DL: 1525 to 1559	✓	✓
25	UL: 1850 to 1915	DL: 1930 to 1995	✓	✓
26	UL: 814 to 849	DL: 859 to 894	✓	✓
27	UL: 807 to 824	DL: 852 to 869	✓	✓
28	UL: 703 to 748	DL: 758 to 803	✓	✓
29	UL: -	DL: 717 to 728	✓	✓
30	UL: 2305 to 2315	DL: 2350 to 2360	✓	✓
31	UL: 452.5 to 457.5	DL: 462.5 to 467.5	✗	✗
32	UL: -	DL: 1452 - 1496	✗	✗
35		1850 to 1910	✓	✓
38		2570 to 2620	✓	✓
39		1880 to 1920	✓	✓
40		2300 to 2400	✓	✓
41		2496 to 2690	✓	✓
42		3400 to 3600	✗	✗
43		3600 to 3800	✗	✗

\*Covered bands represent an efficiency greater than 20%

### 3. LTE MIMO

#### 3.1. LTE MIMO1 and 2 Characteristics

##### 3.1.1. Return Loss on 30\*30cm GND

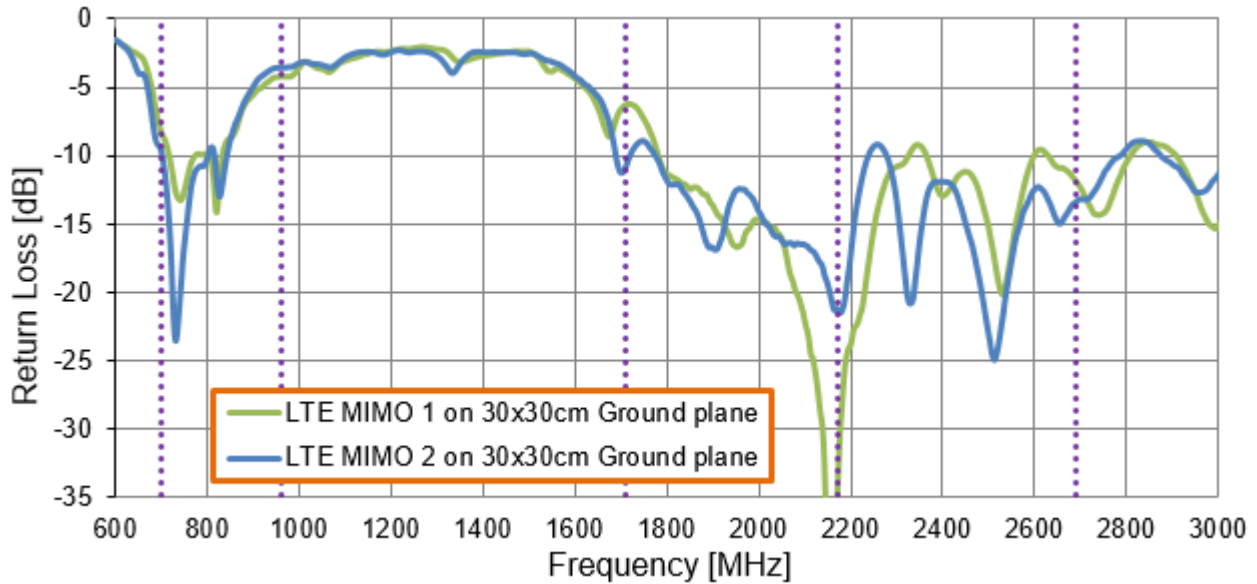

##### 3.1.2. Efficiency on 30\*30cm GND

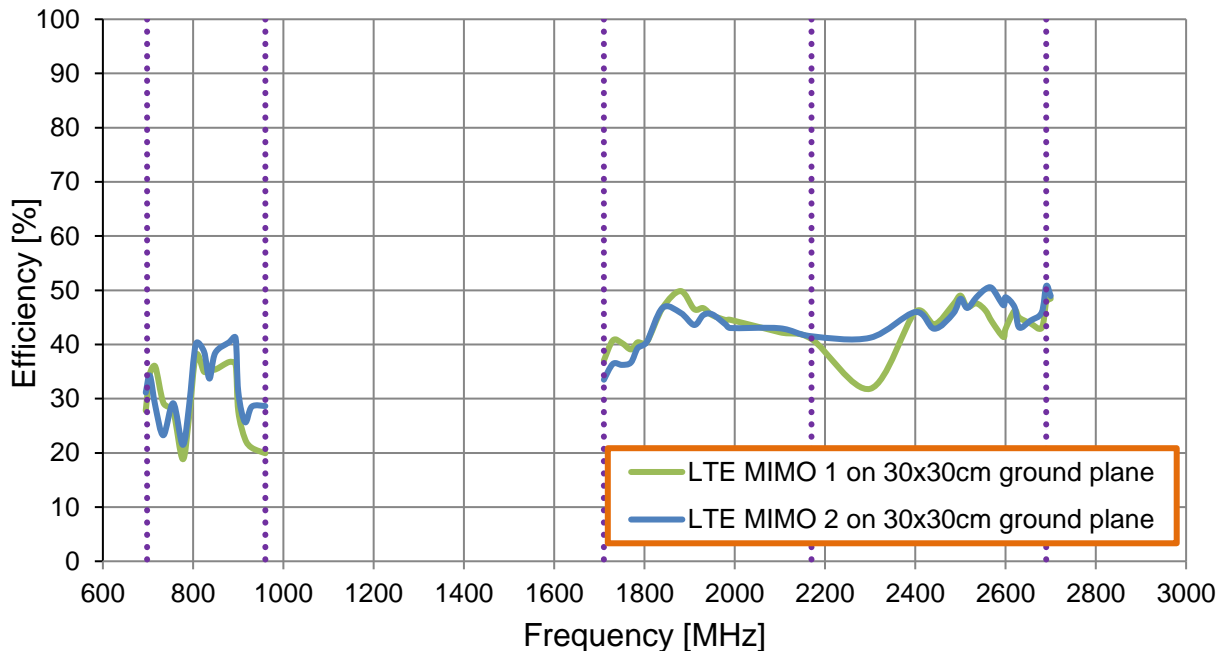



### 3.1.3. Peak Gain on 30\*30cm GND

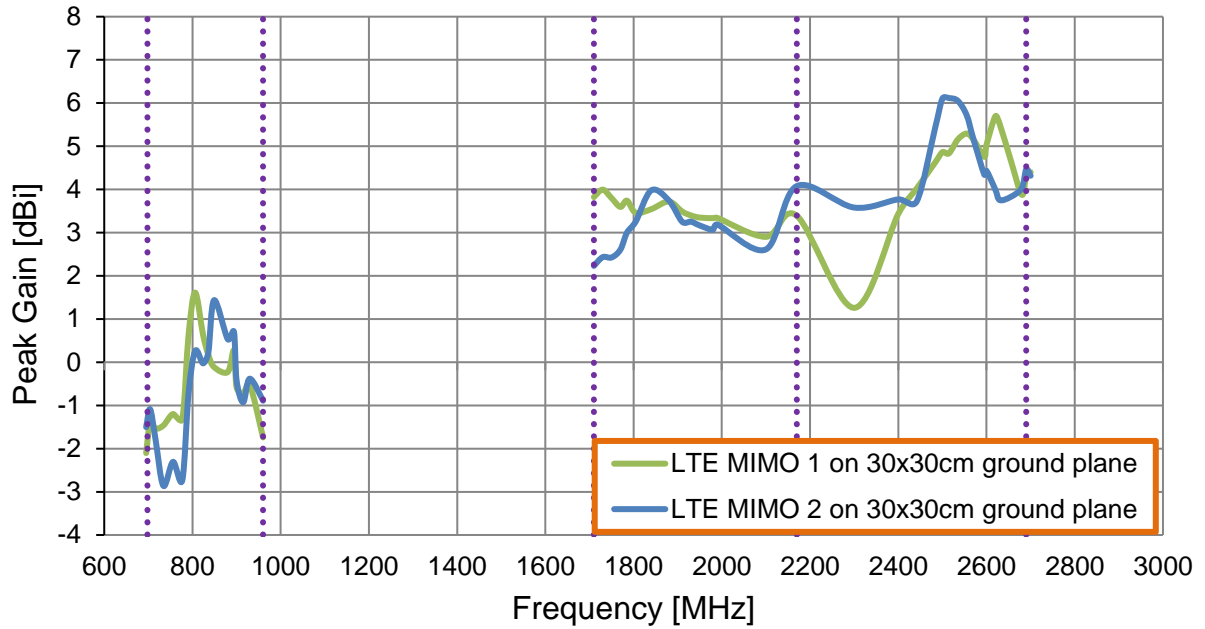

### 3.1.4. Average Gain on 30\*30cm GND

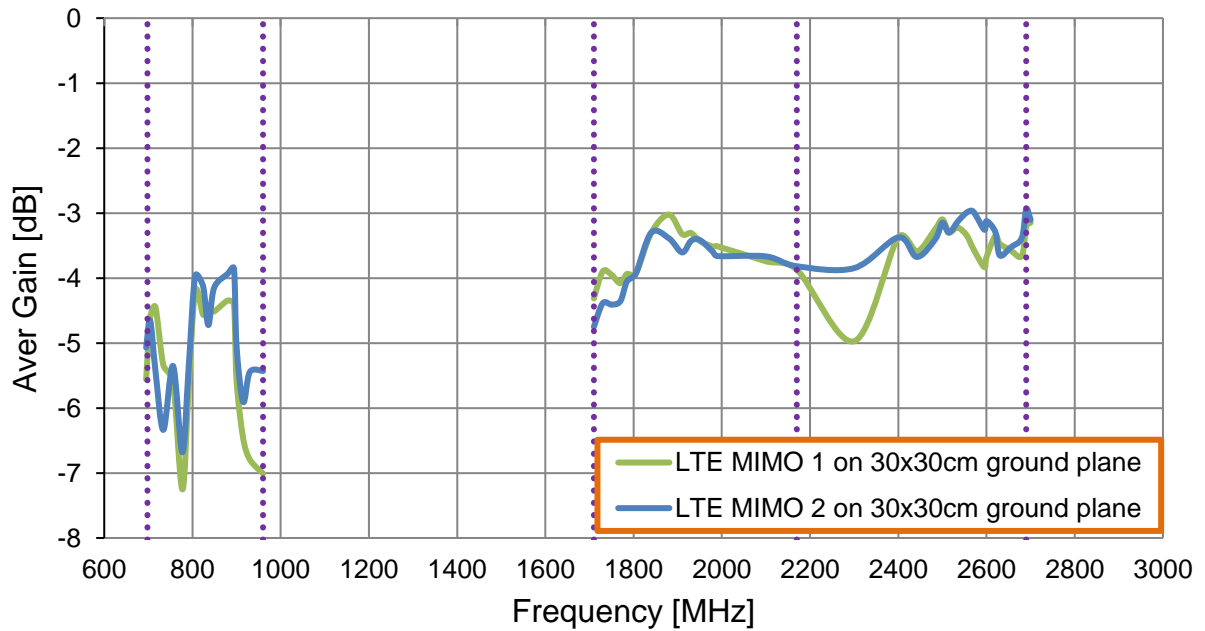



## 3.2. LTE Characteristics with different cable length

### 3.2.1. MIMO 1 Efficiency

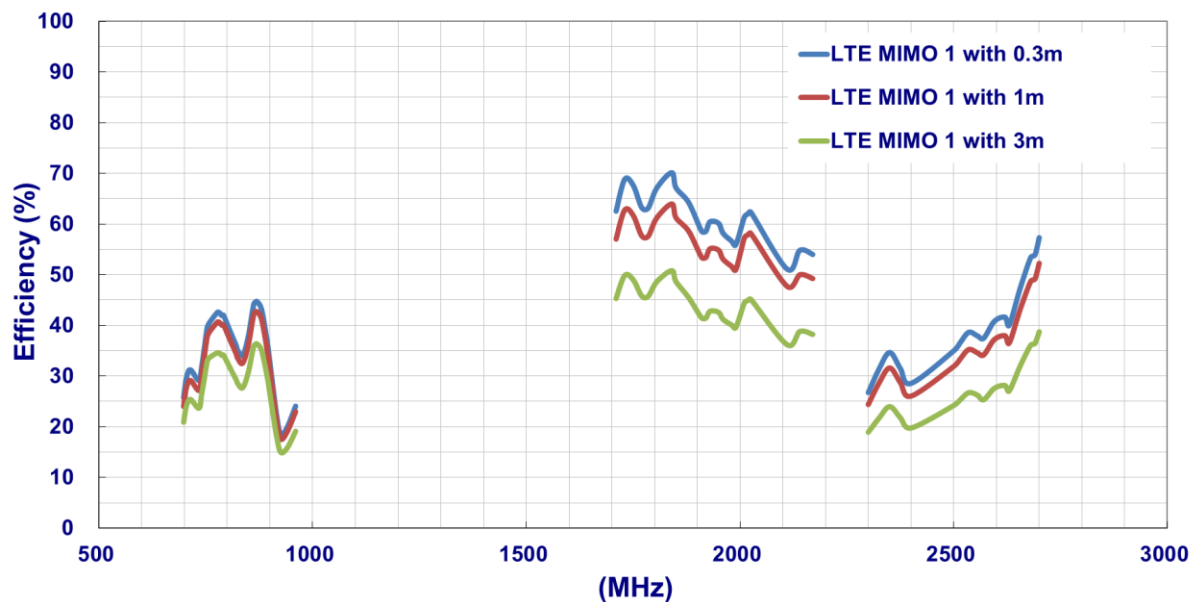

### 3.2.2. MIMO 1 Peak Gain

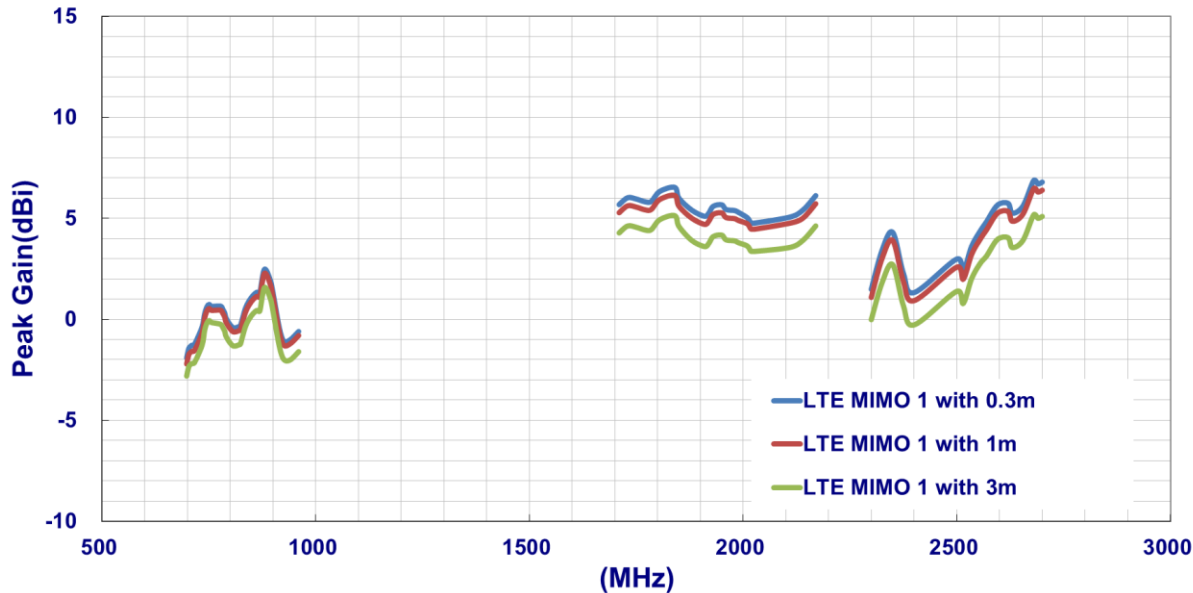

### 3.2.3. MIMO 1 Average Gain

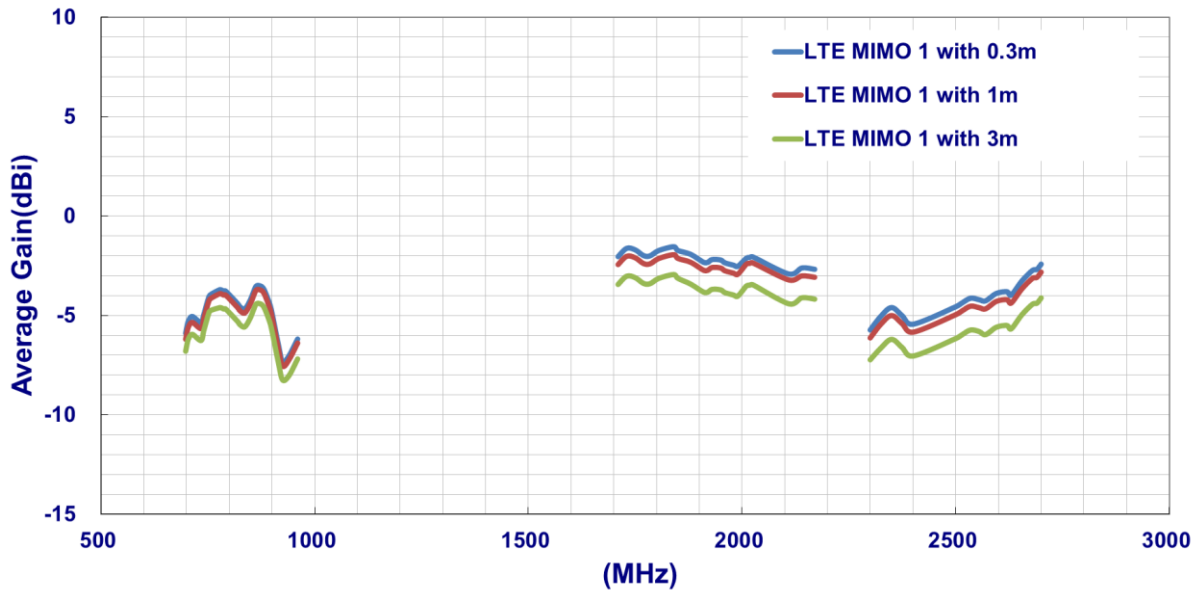

### 3.2.4. MIMO 2 Efficiency

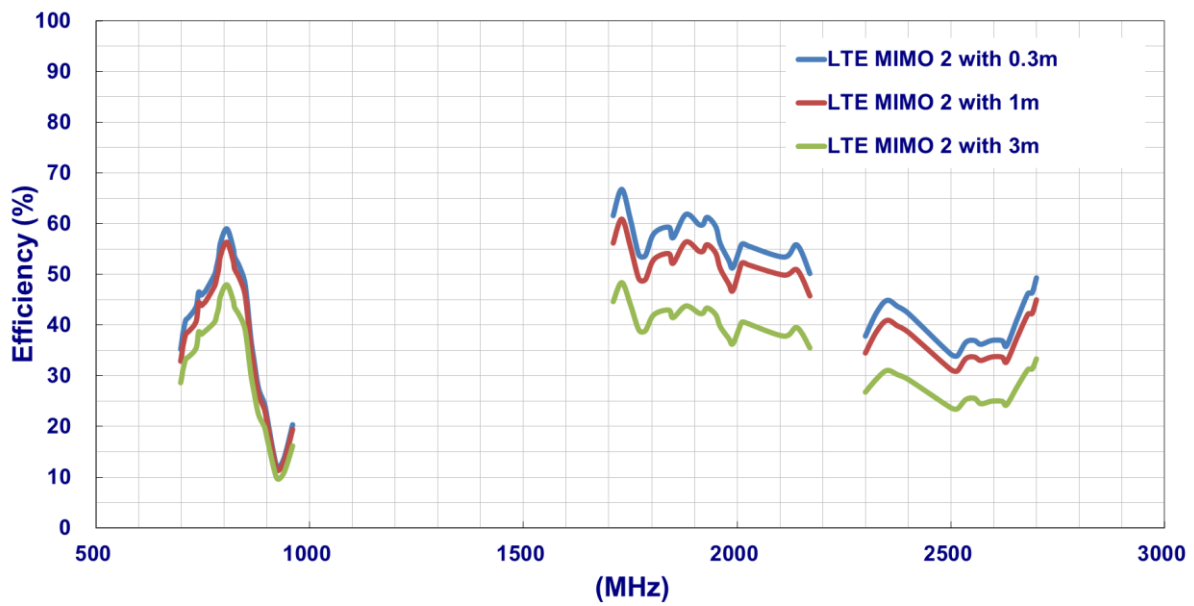



### 3.2.5. MIMO 2 Peak Gain

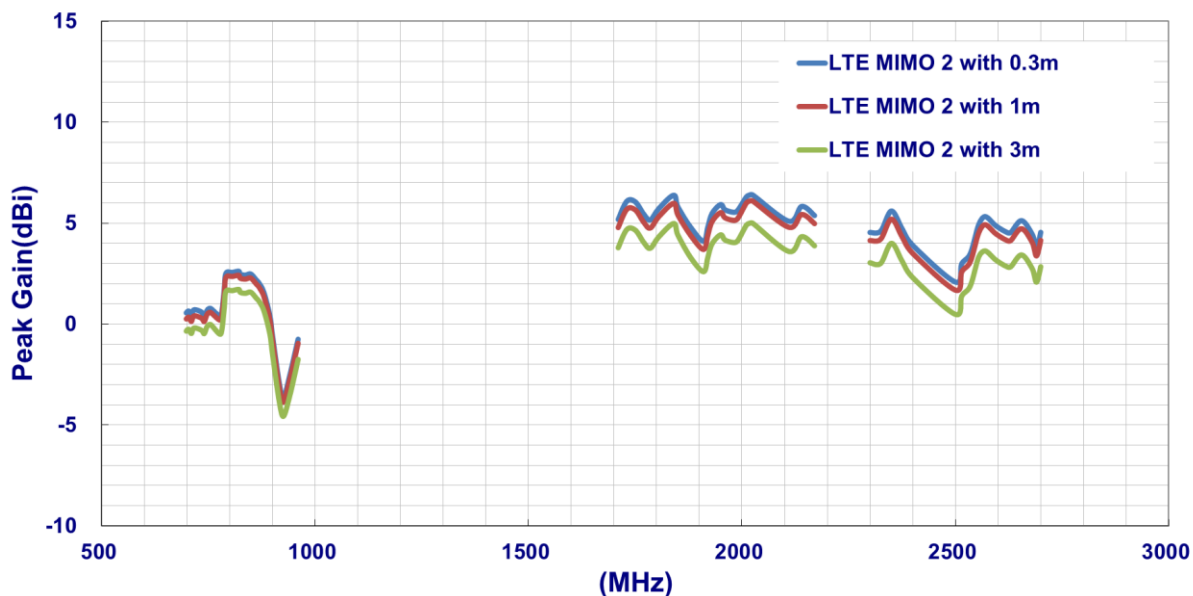

### 3.2.6. MIMO 2 Average Gain

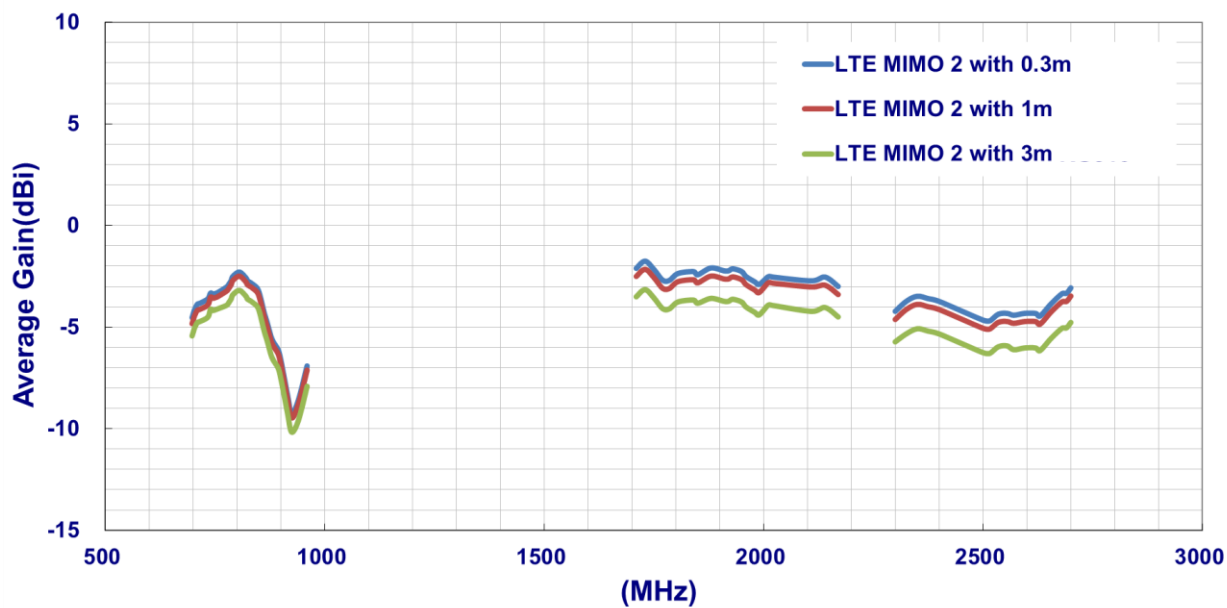

### 3.3. 3D Radiation Pattern

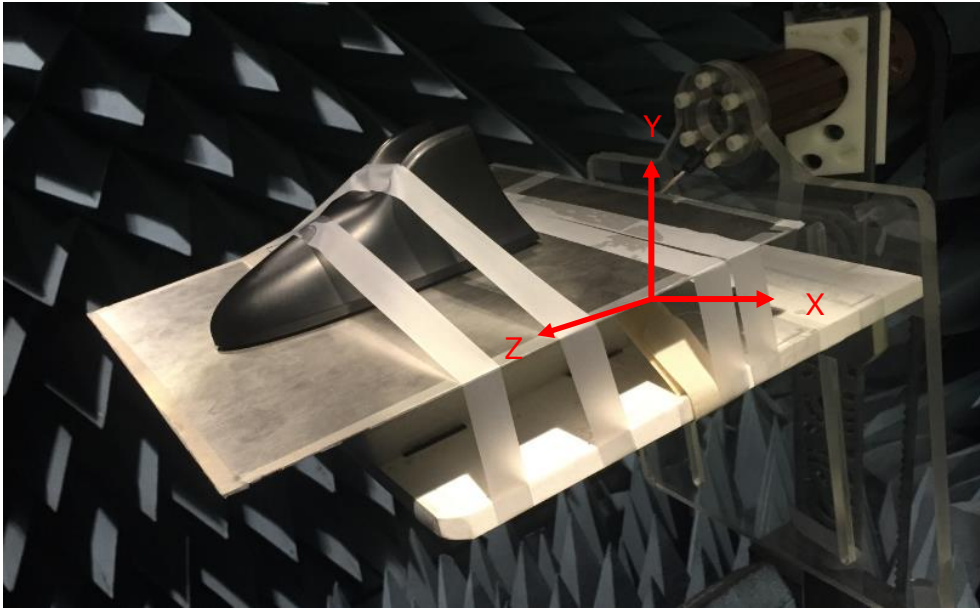



## 3.3.1. LTE MIMO1 3D Radiation Pattern

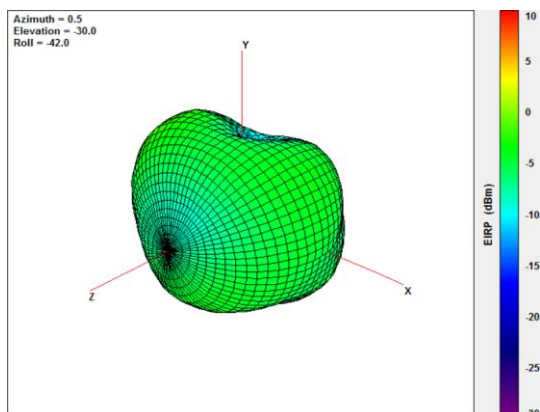

@756MHz

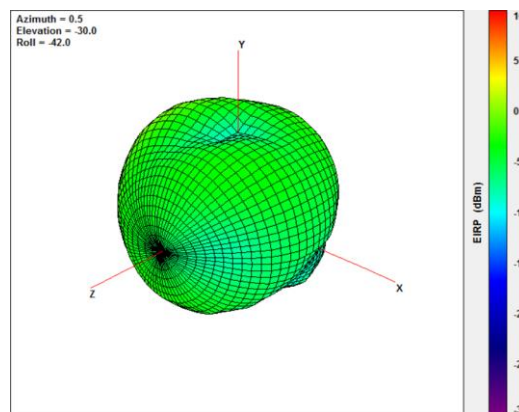

@824MHz

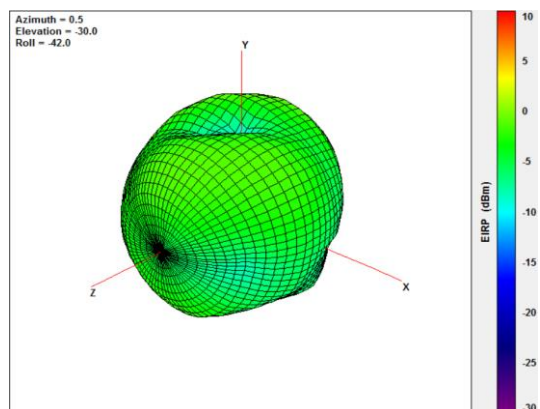

@880MHz

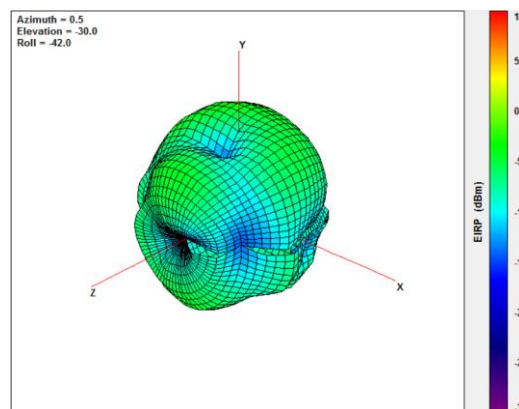

960MHz

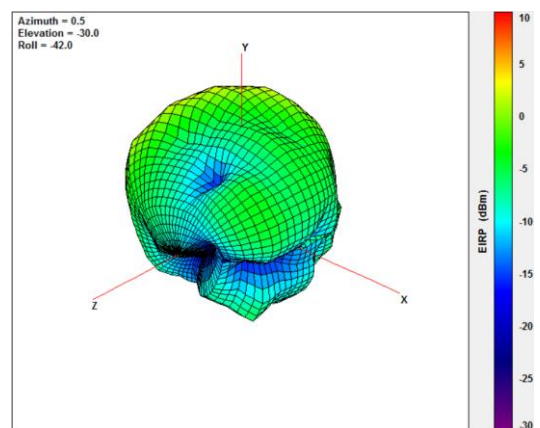

@1710MHz

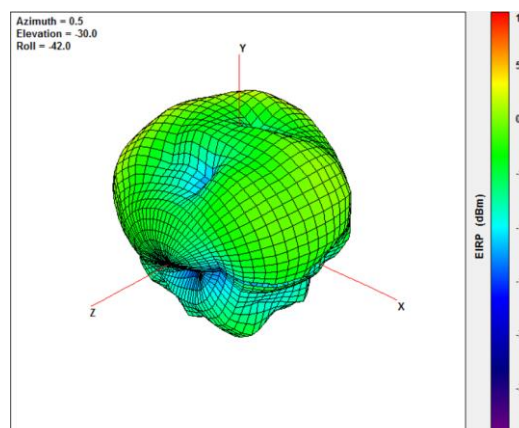

@1880MHz



# TAOGLAS®

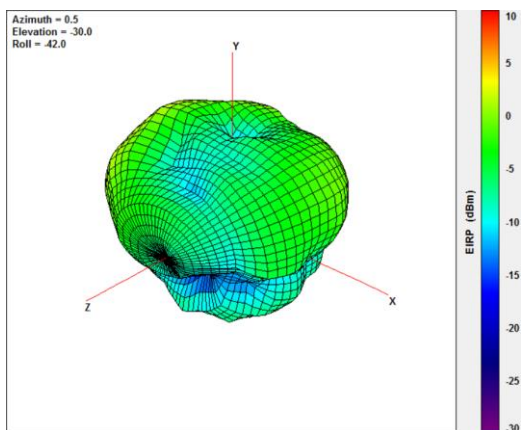

@1990MHz

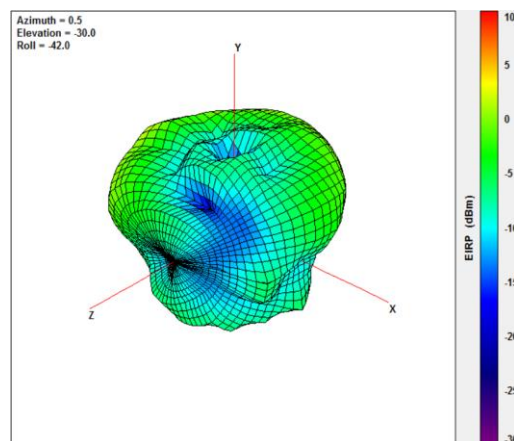

@2170MHz

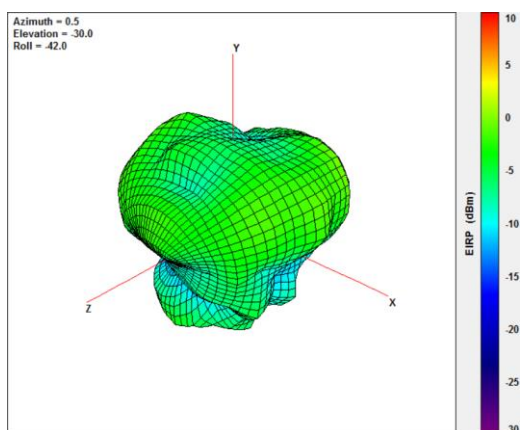

@2300MHz

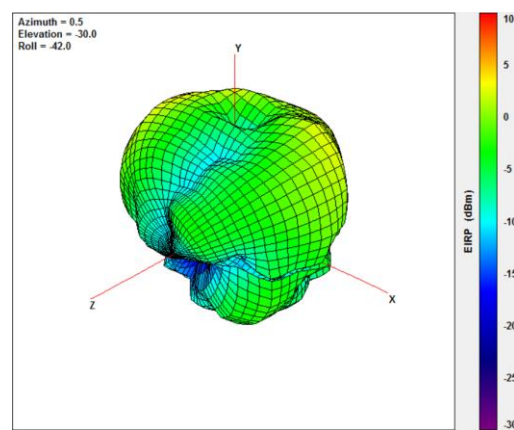

@2500MHz

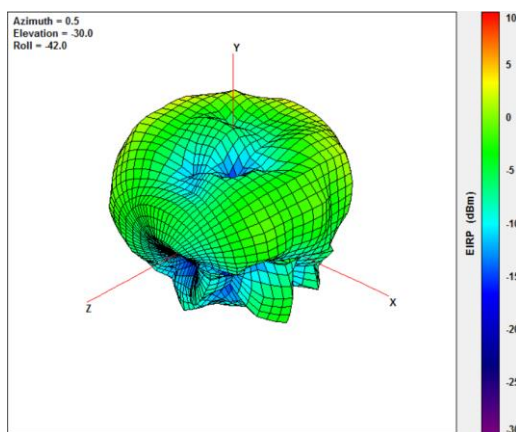

@2690MHz



## 3.3.2. LTE MIMO2 3D Radiation Pattern

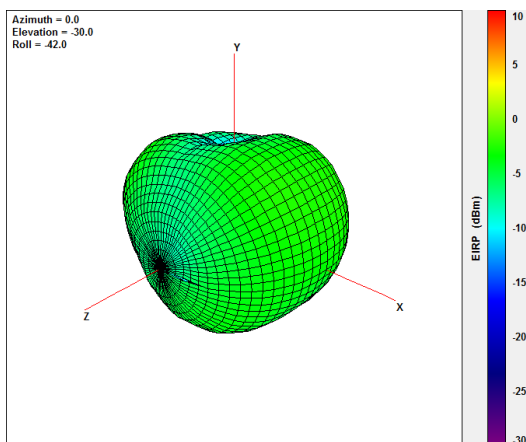

@756MHz

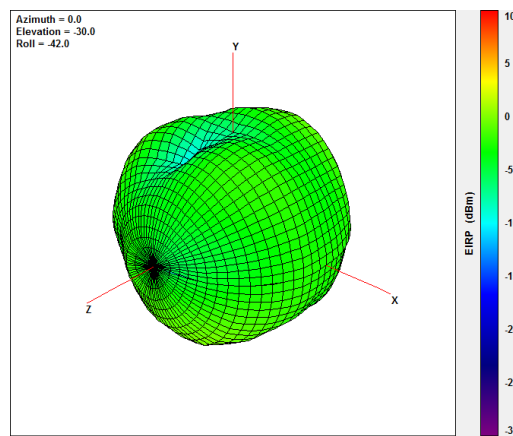

@824MHz

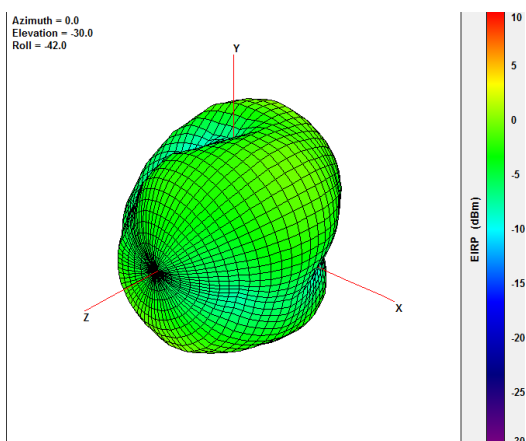

@88MHz

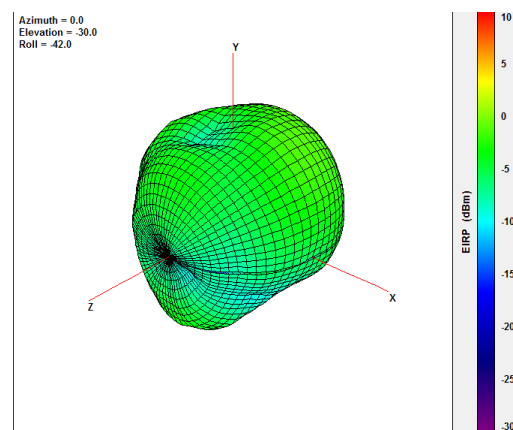

@960MHz

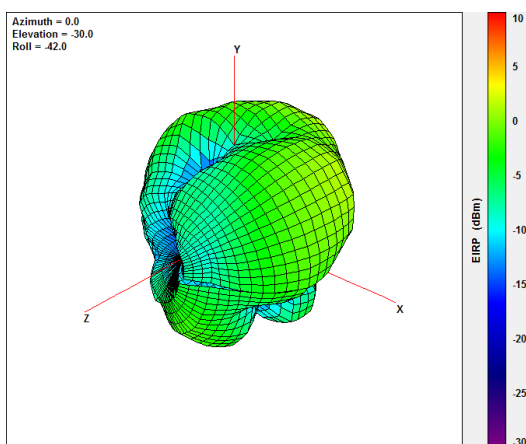

@1710MHz

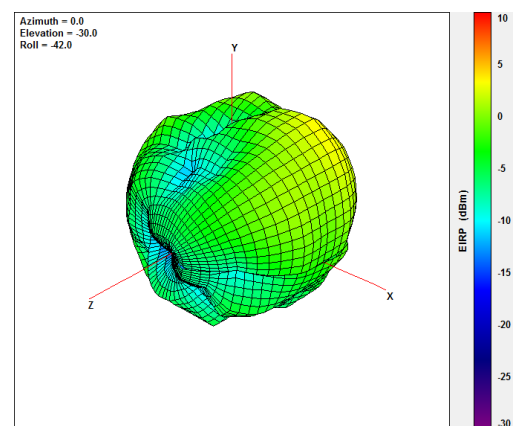

@1880MHz





# TAOGLAS®

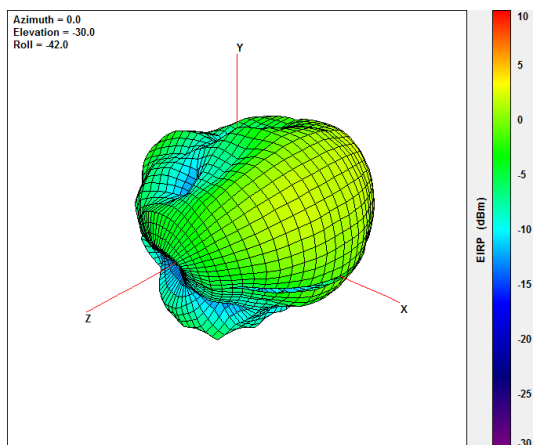

@1990MHz

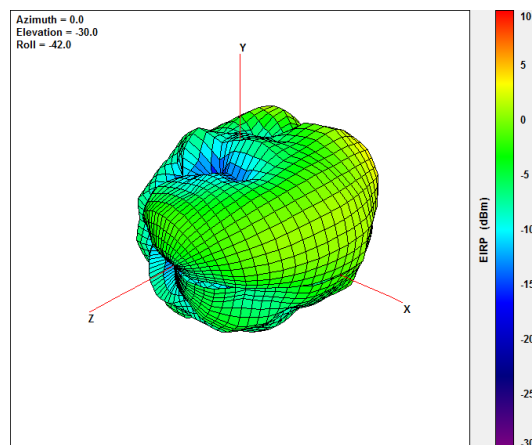

@2170MHz

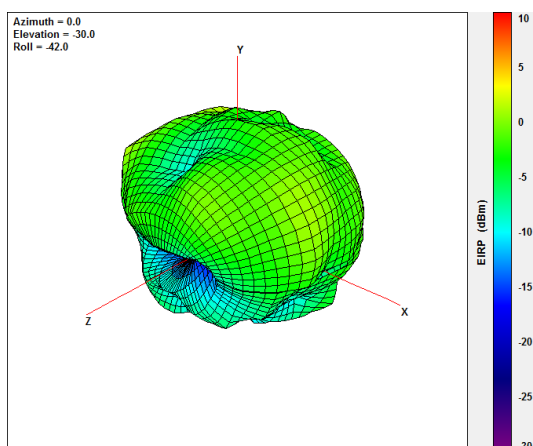

@2300MHz

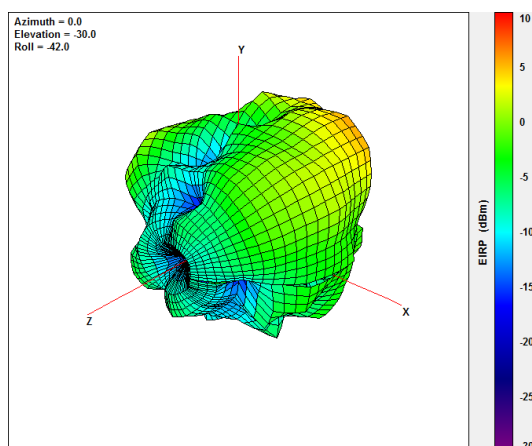

@2500MHz

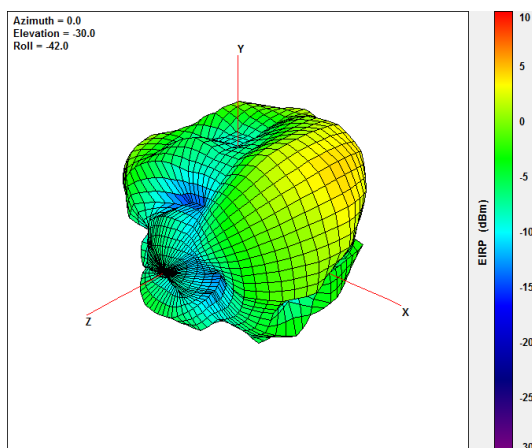

@2690MHz

## 4. Wi-Fi 2.4/5.8GHz

### 4.1. Wi-Fi 2.4/5.8GHz Characteristics

#### 4.1.1. Return Loss on 30\*30cm GND

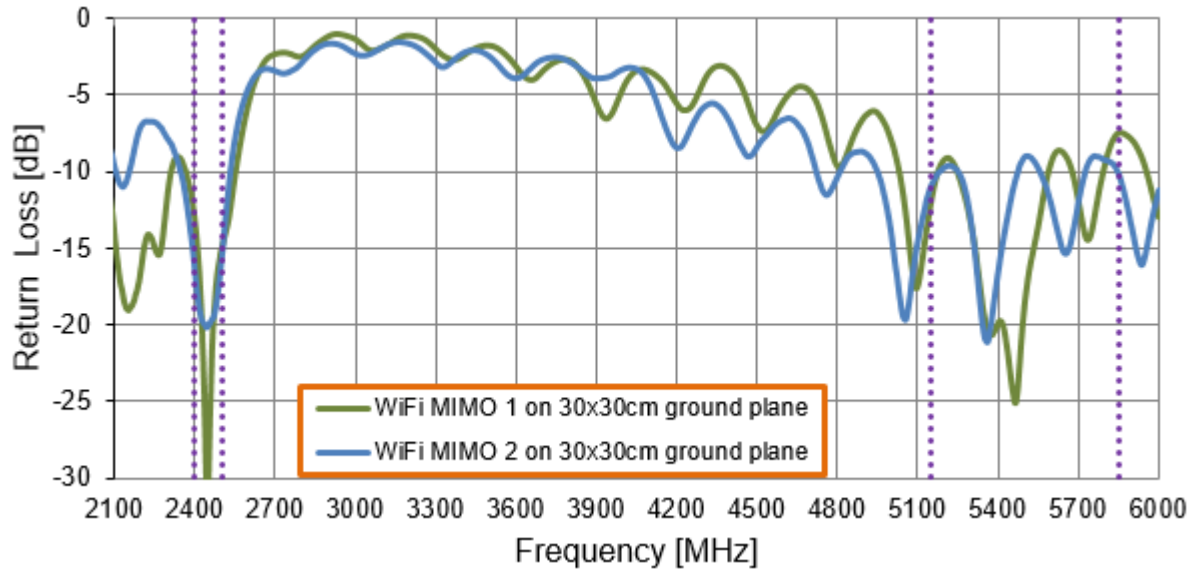

#### 4.1.2. Isolation on 30\*30cm GND

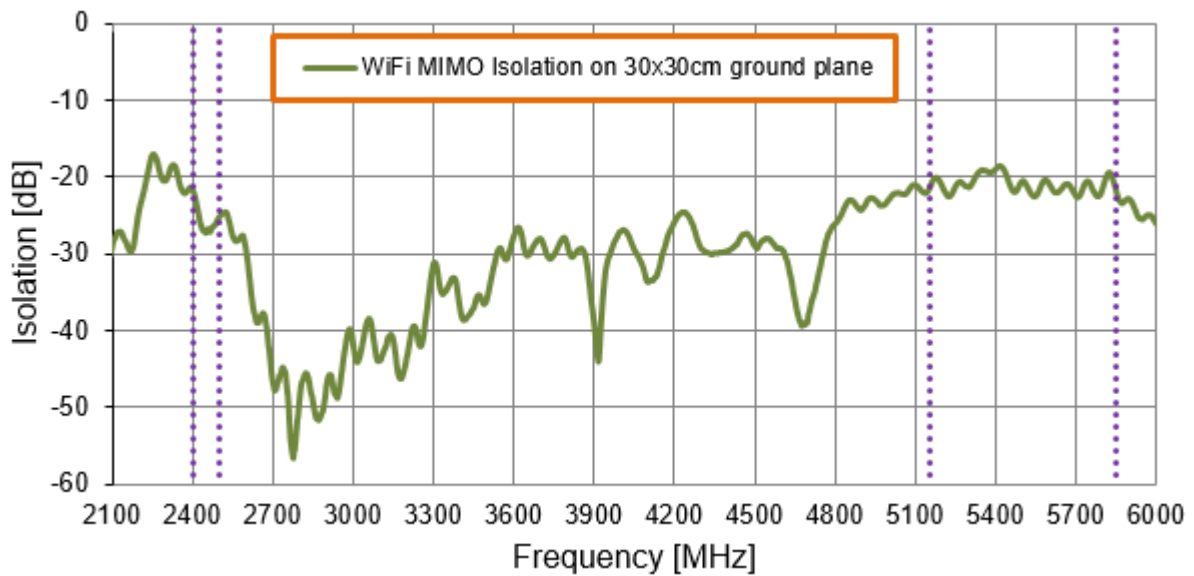

#### 4.1.3. Average Gain on 30\*30cm GND

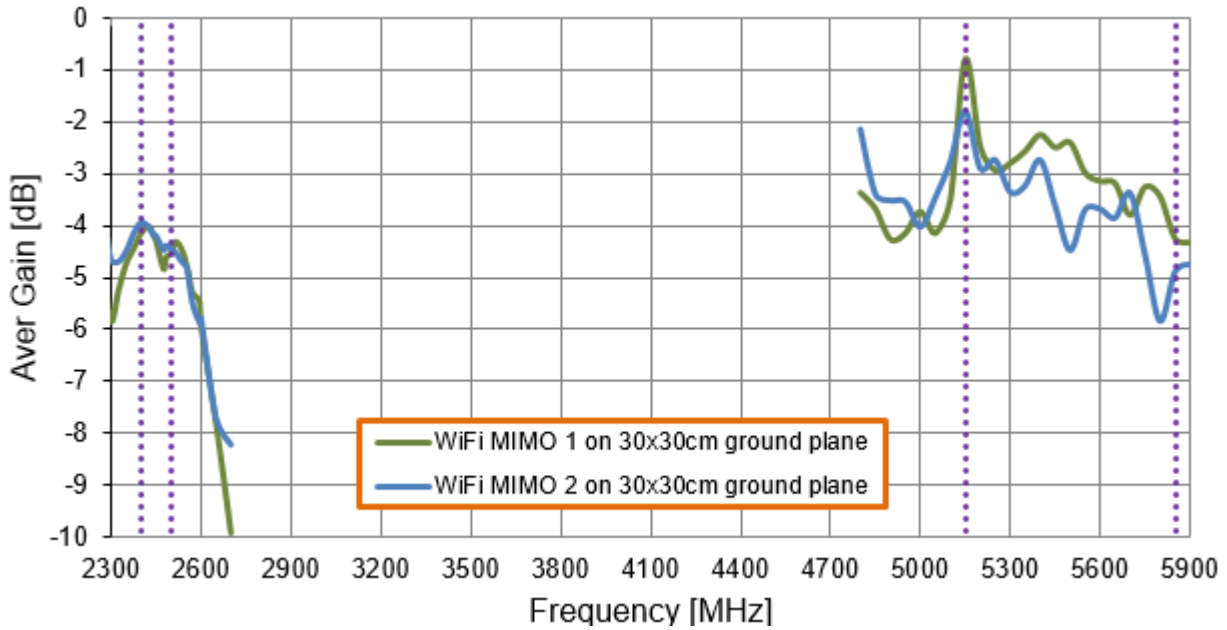

#### 4.1.4. Peak Gain on 30\*30cm GND

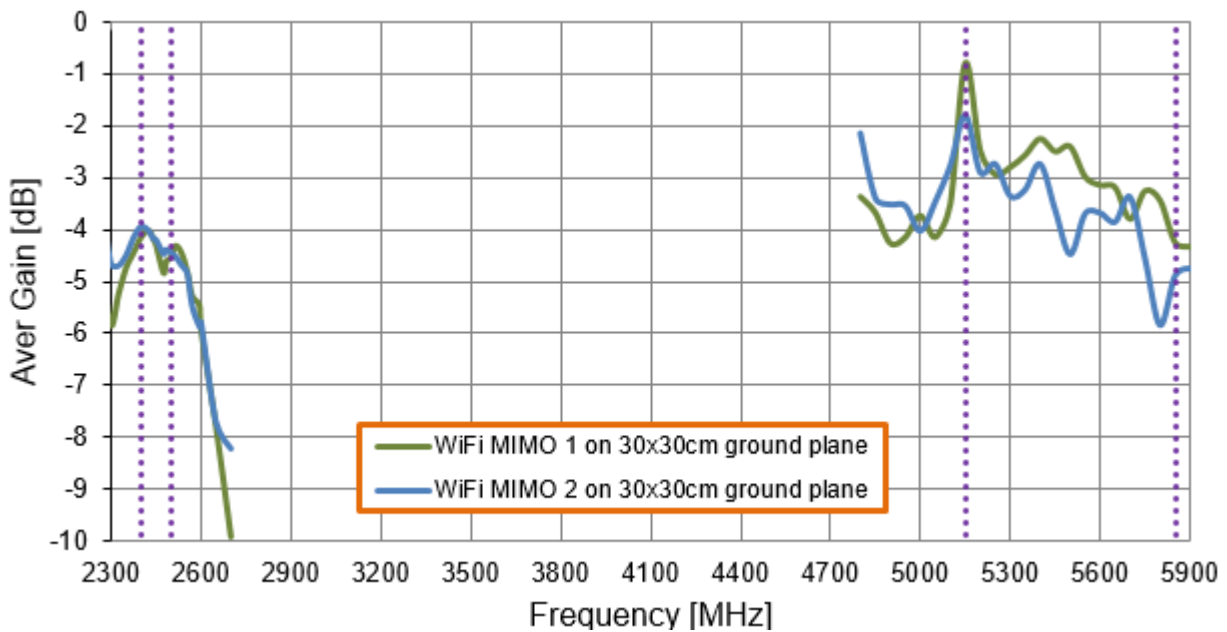

#### 4.1.5. Efficiency on 30\*30cm GND

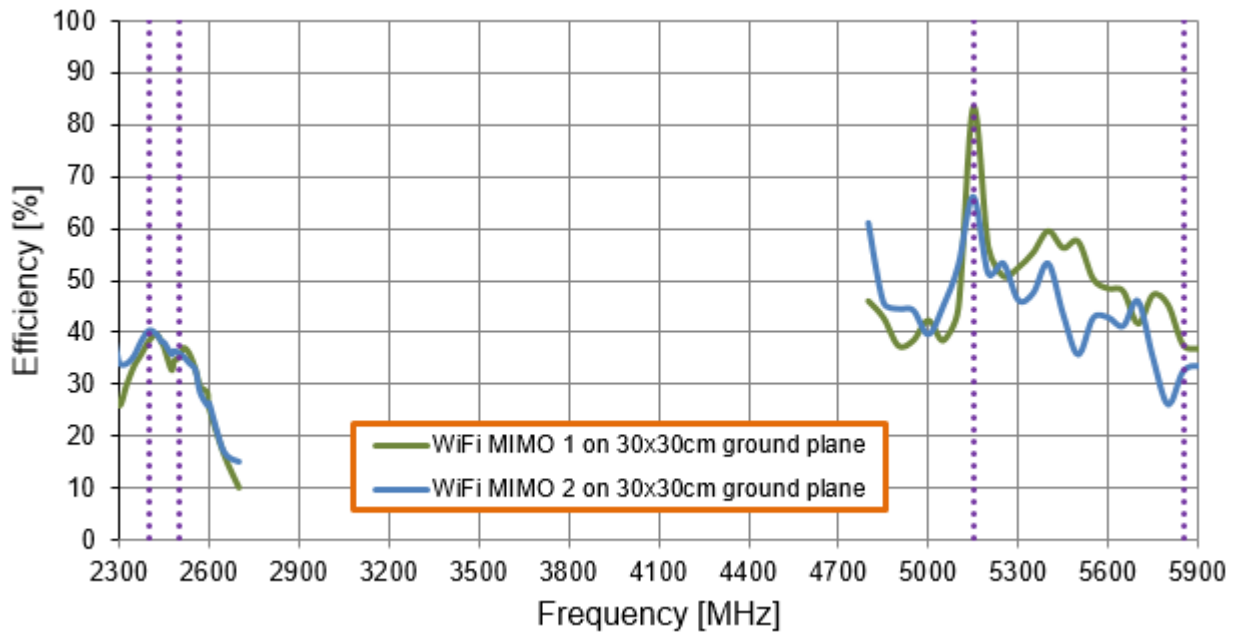

## 4.2. Wi-Fi Characteristics with different cable length

### 4.2.1. Average Gain

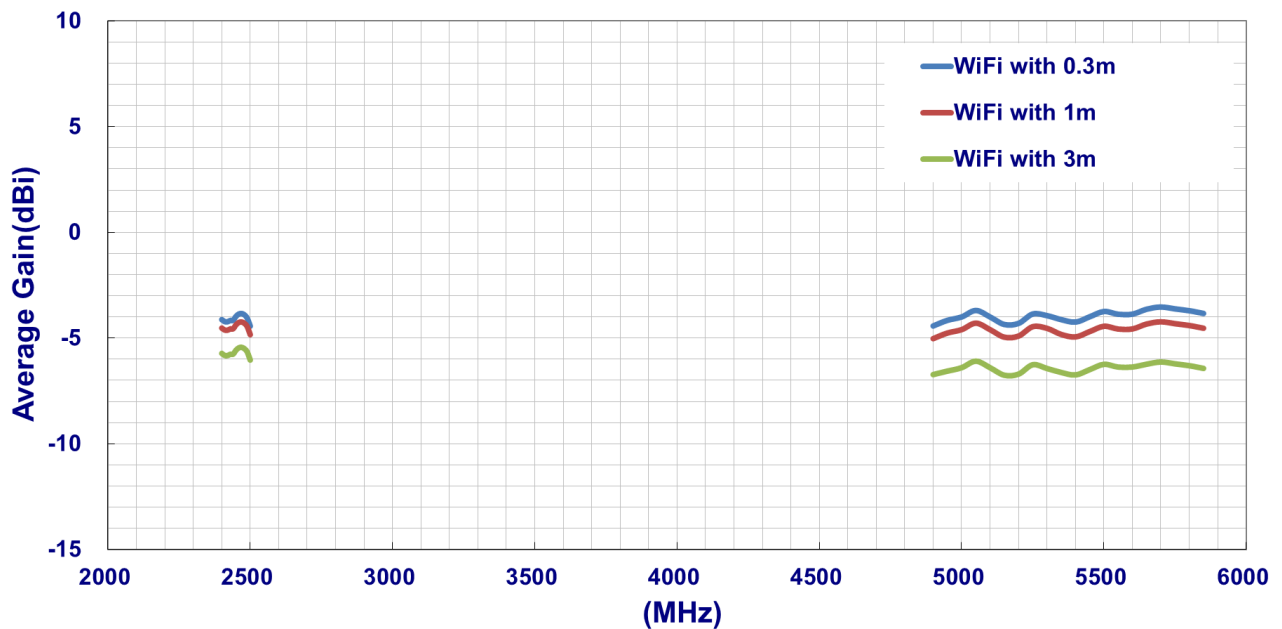

### 4.2.2. Peak Gain

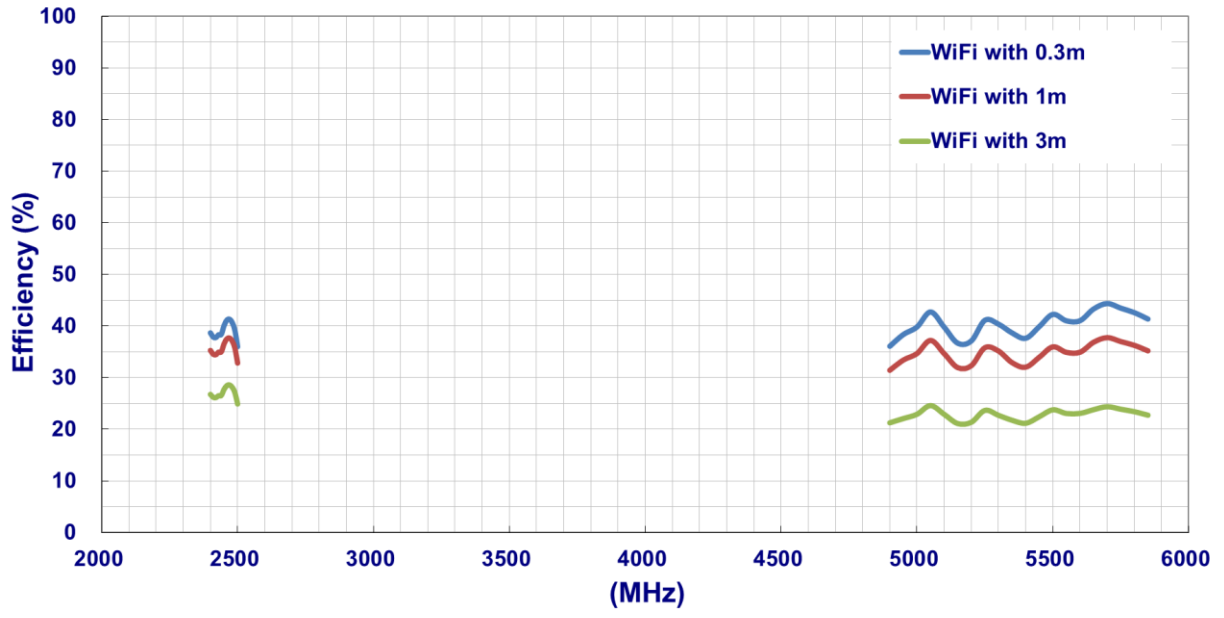

### 4.2.3. Efficiency

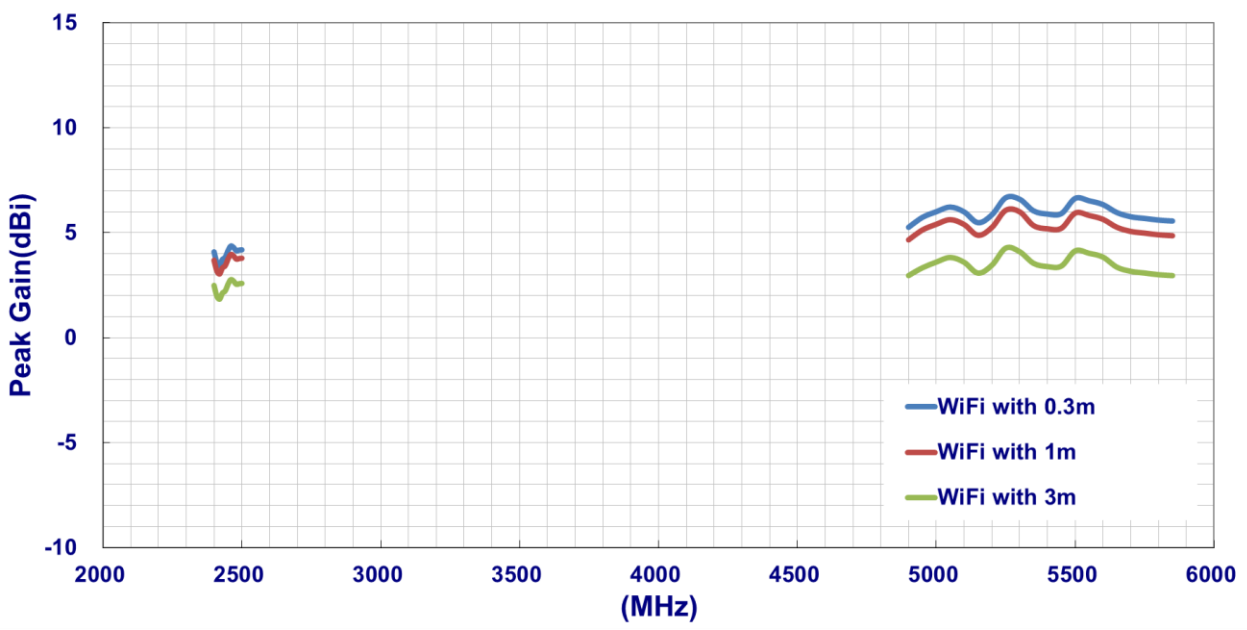

### 4.3. 3D Radiation Patterns

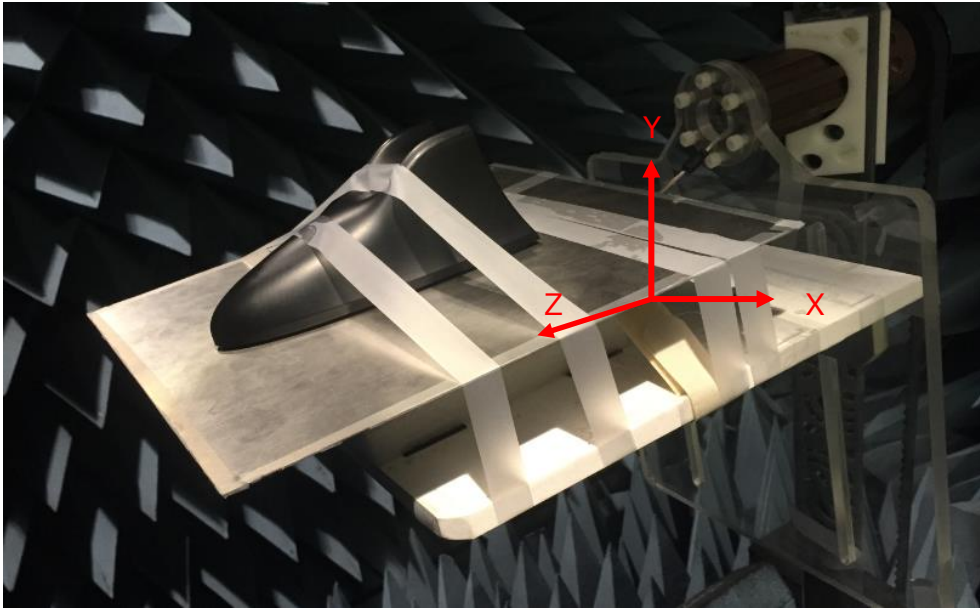



## 4.3.1. 2.4/5.8GHz Wi-Fi MIMO1 3D Radiation Pattern

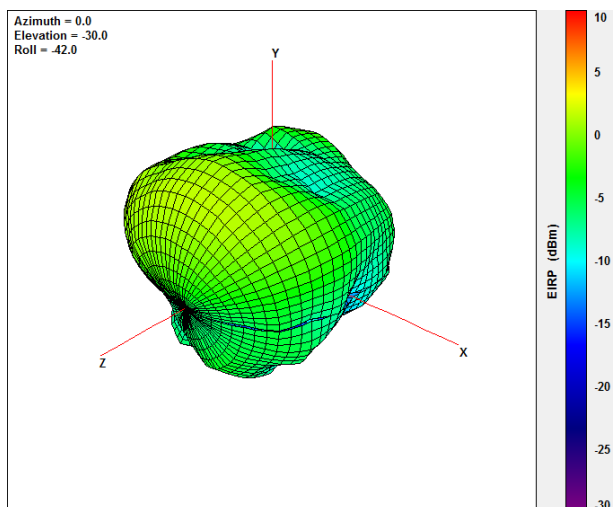

@2450MHz

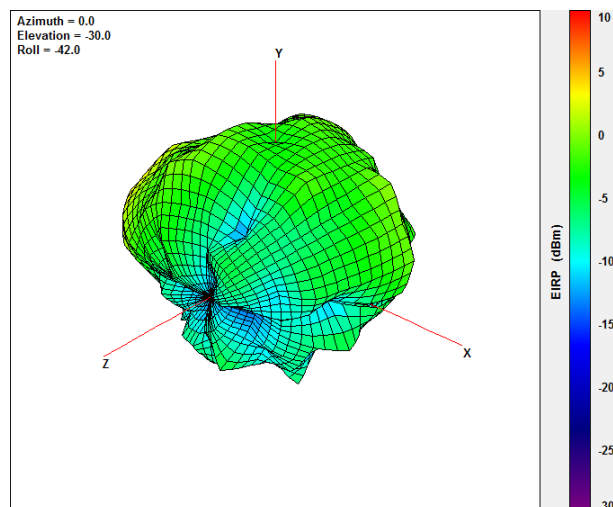

@5550MHz

## 4.3.2. 2.4/5.8GHz Wi-Fi MIMO2 3D Radiation Pattern

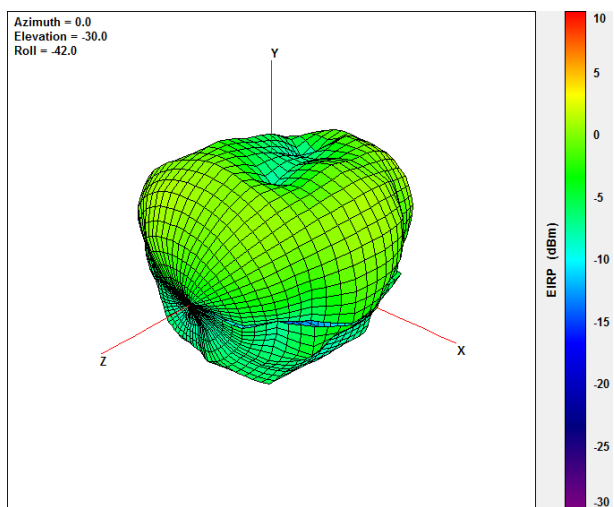

@2450MHz

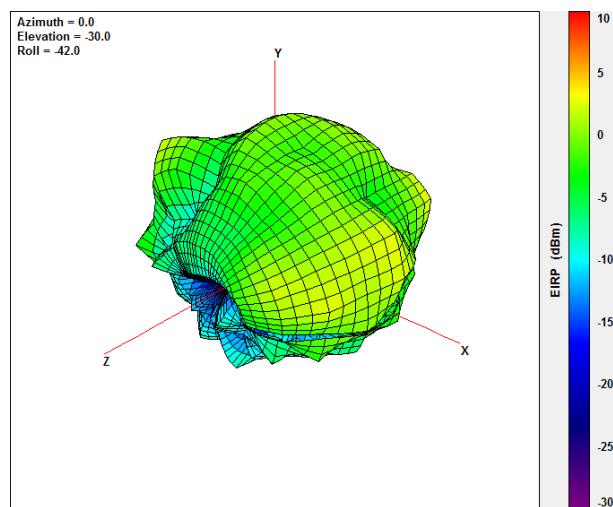

@5550MHz

## 5. C-V2X/DSRC 5.9GHz

### 5.1. C-V2X/DSRC 5.9GHz Characteristics

#### 5.1.1. Average Gain on 50\*50cm GND

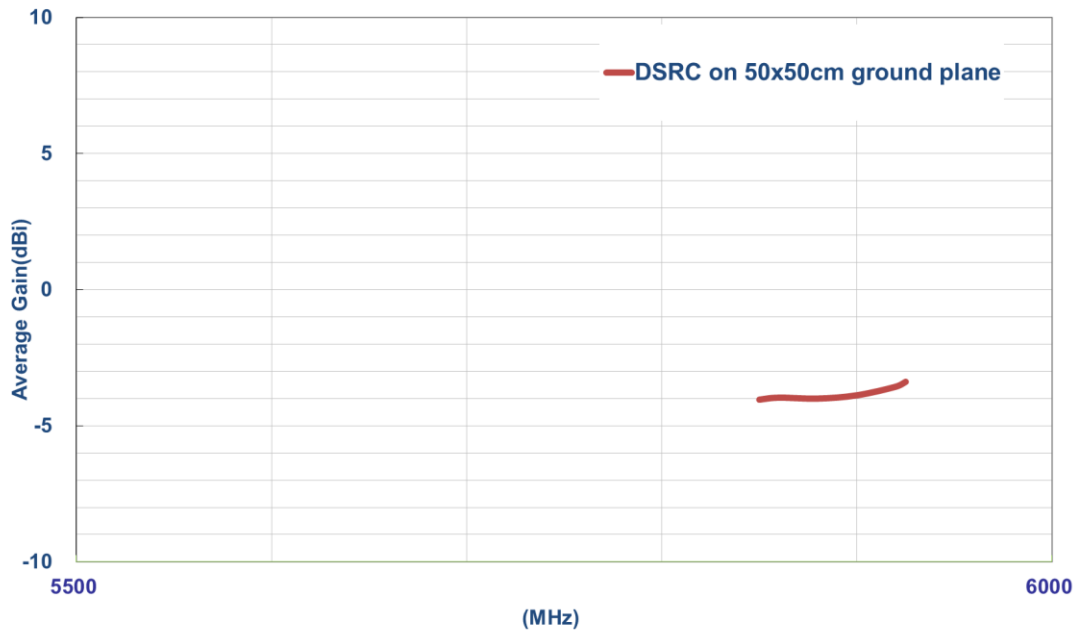

#### 5.1.2. Peak Gain on 50\*50cm GND

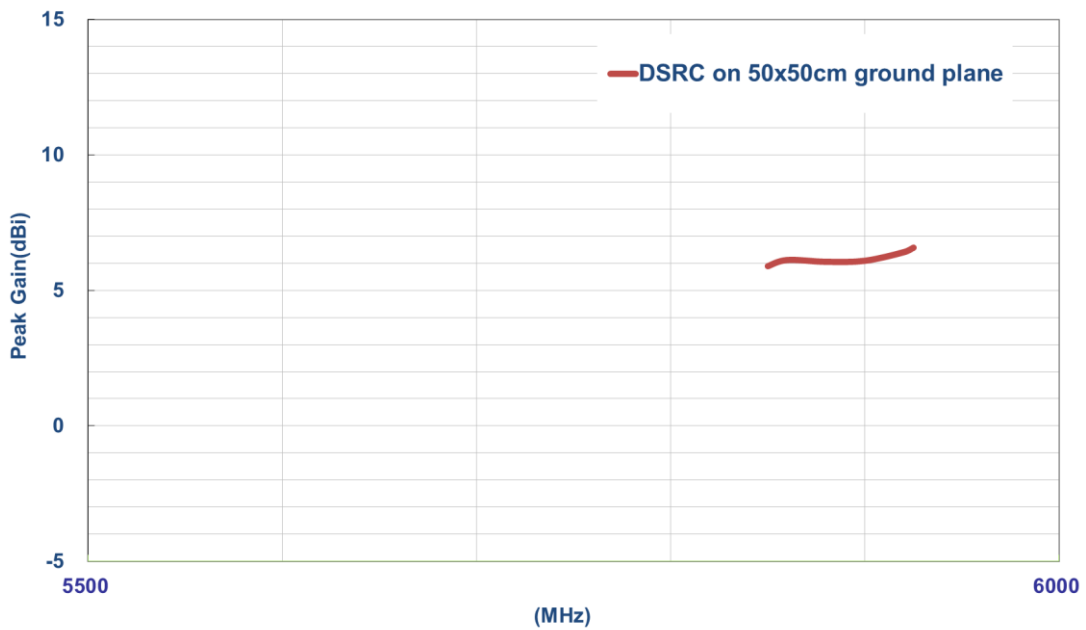



5.1.3. Efficiency on 50\*50cm GND

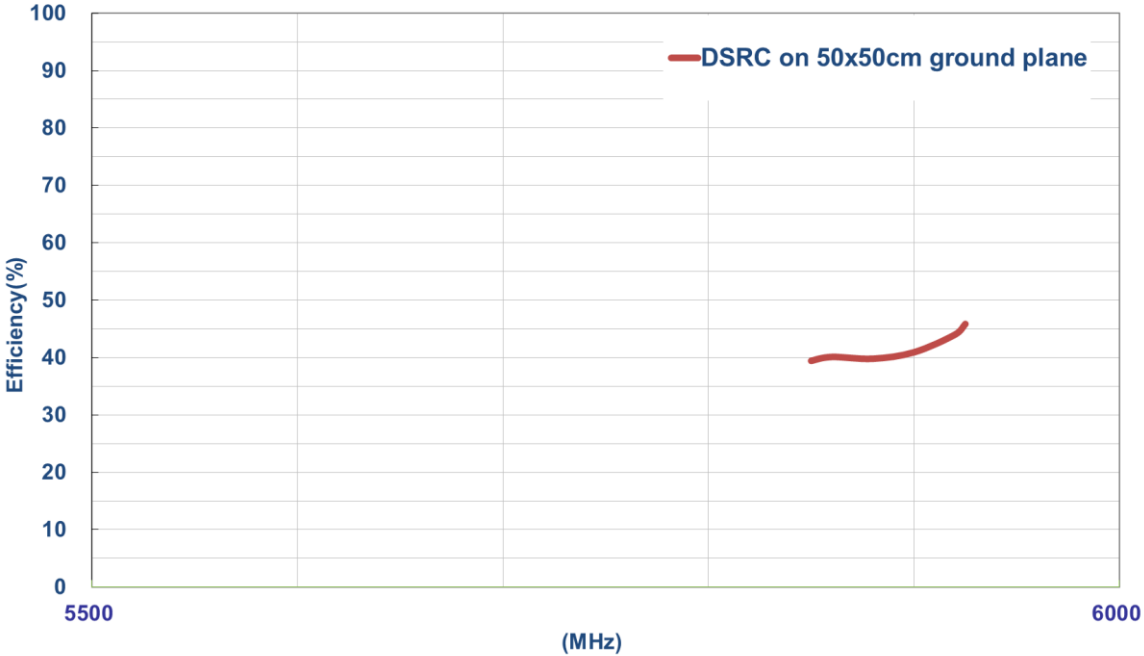

5.2. C-V2X/DSRC Characteristics with different cable length

5.2.1. Average Gain

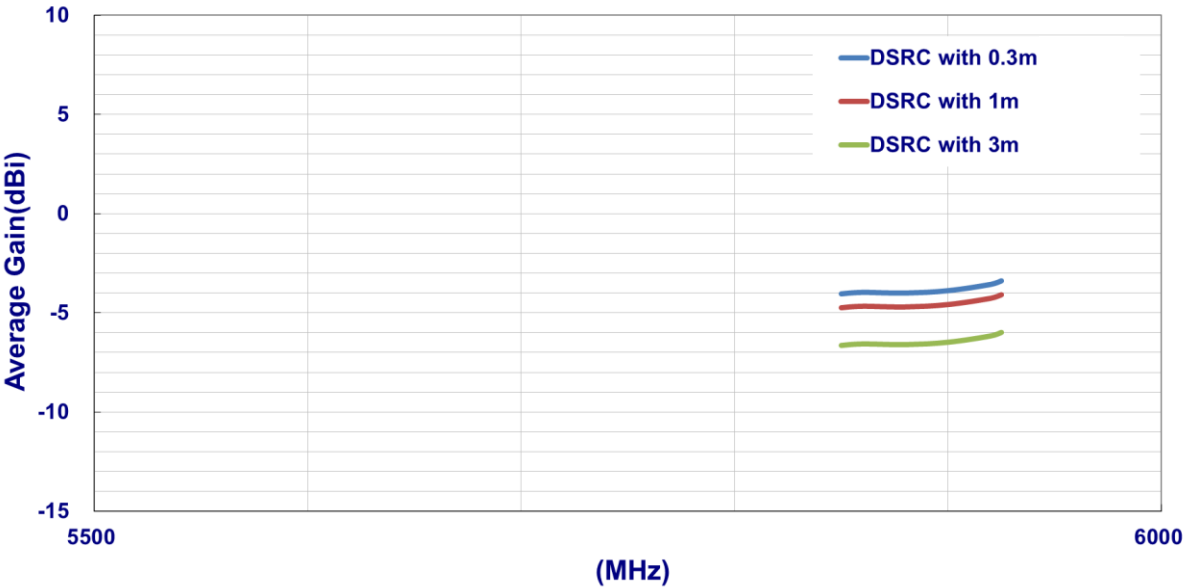

### 5.2.2. Peak Gain

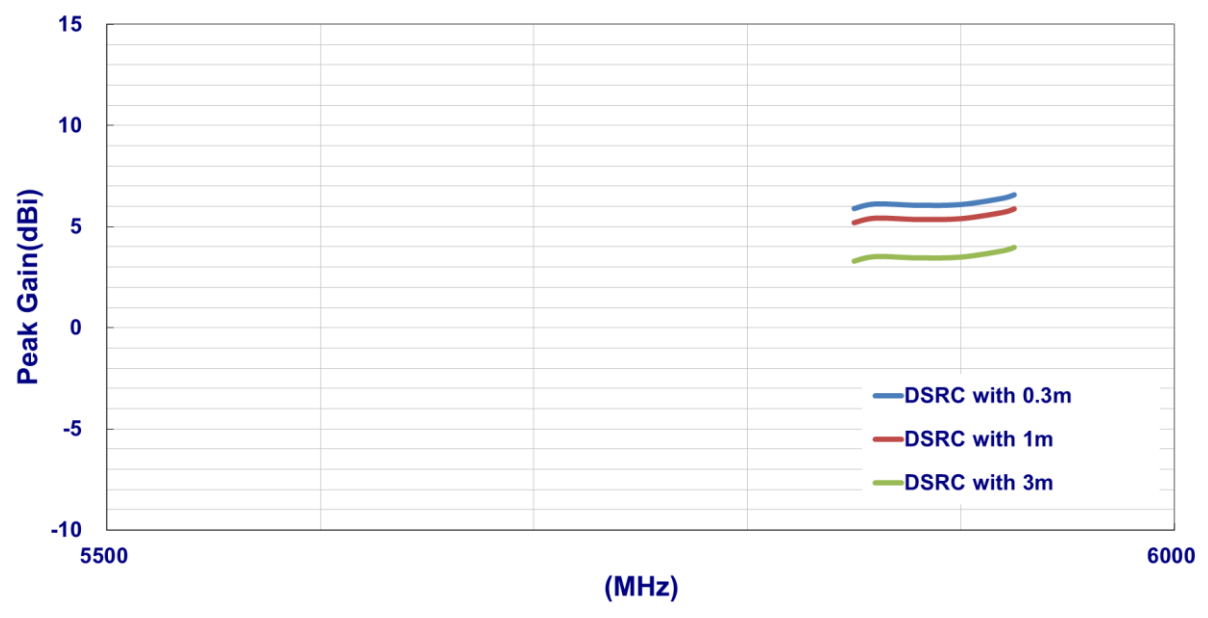

### 5.2.3. Efficiency

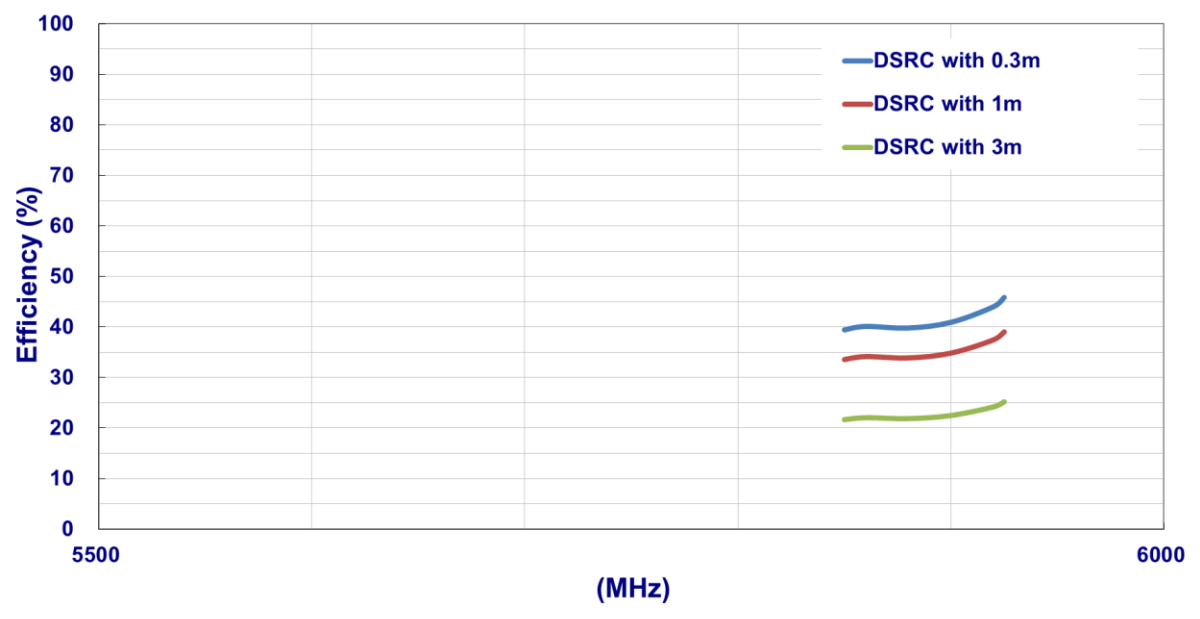



## 6. Drawing

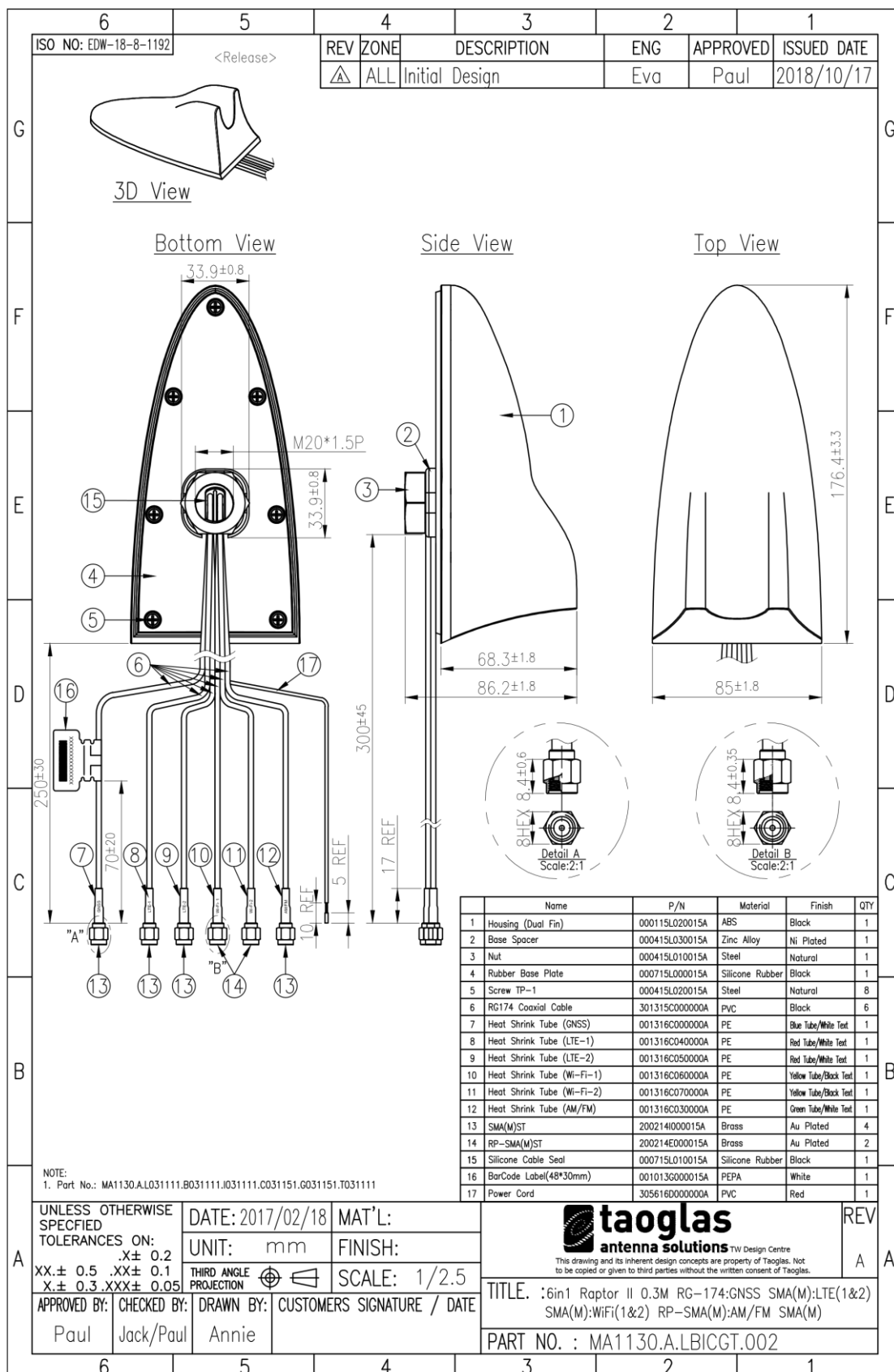

## 7. Packaging

1 pcs MA1130.A.LBICGT.002 per Blister Top Cover  
 Blister Top Dimensions - 211 x 110 x 85mm  
 Weight - 390g

16 pcs MA1130.A.LBICGT.002 per carton  
 Carton - 570 x 510 x 345mm  
 Weight - 10.8Kg

Pallet Dimensions 1140 x 1020 x 1200mm  
 12 Cartons per Pallet  
 6 Cartons per layer  
 2 Layers

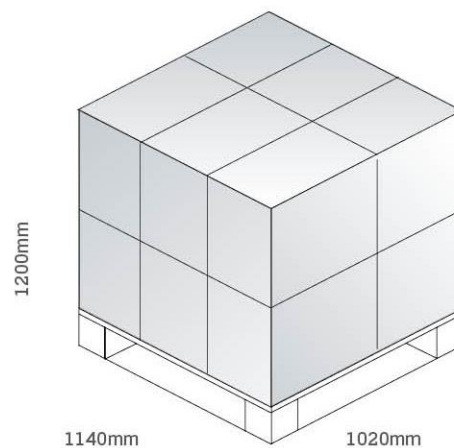
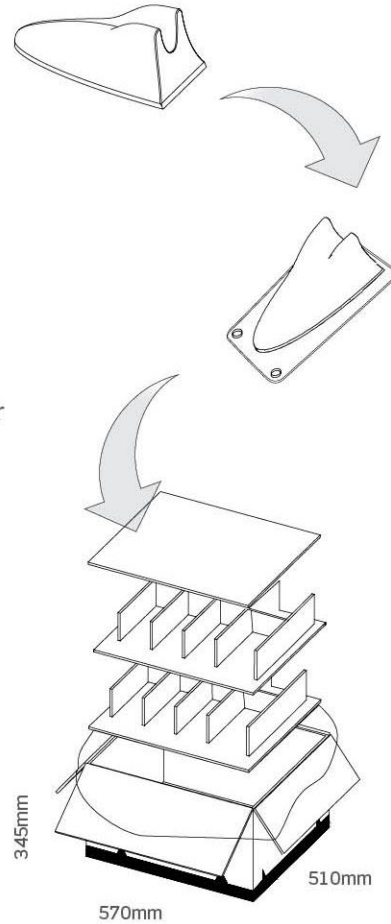

Taoglas makes no warranties based on the accuracy or completeness of the contents of this document and reserves the right to make changes to specifications and product descriptions at any time without notice. Taoglas reserves all rights to this document and the information contained herein.

Reproduction, use or disclosure to third parties without express permission is strictly prohibited.

© Taoglas