

SPECIFICATION

Part No.	:	MA530.A.CG.003
Product Name	:	Taoglas "Ultima" Antenna Heavy Duty Screw Mount Antenna 2 x MIMO Dual-Band 2.4/5.0GHz
Features	:	2.4GHz/5.0GHz suitable for ISM Bands/ZigBee/WLAN/Bluetooth IEEE.802.11n/IEEE.802.11ac High Isolation between Antenna Elements PC housing Waterproof IP67 & IP69K Rated Height 19.6mm Diameter 55.23mm

RoHS Compliant



1. Introduction

The MIMO communication system has been one of the most promising technologies, well suited for high data rate communication. A MIMO (Multiple-Input-Multiple-Output) system use at least two antenna structures and is more advantageous than single-input single-output (SISO) in an aspect of increasing channel capacity and reducing transmitting power. MIMO antennas should have compact structure, high radiation efficiency, low envelope correlation, and high isolation between the signal ports.

In small structures (antennas spaced closely), the application of MIMO technology has been restricted by high degree of coupling and spatial correlation between antenna elements due to the limited available space. The isolation between antennas become critical as it can deteriorate the system performance and decreases channel capacity.

The Ultima MA530 MIMO antenna is low profile, heavy-duty, fully IP67 waterproof external M2M antenna for use, transportation and remote monitoring applications. This unique omnidirectional antenna provide high efficiency and high isolation between antennas elements in a heavy-duty low profile compact structure, delivering powerful MIMO antenna technology for Wi-Fi 802.11n and emerging 802.11ac.

The antenna screws down permanently onto a roof or metal panel and can be pole or wall-mounted. One antenna elements is vertically polarized and one is horizontally polarized to increase the isolation between antennas.

For industries such as remote monitoring, smart meter systems, construction equipment, public safety at only 19.6mm high, the Ultima MA530 MIMO antenna provides an unobtrusive, robust, rugged antenna that is durable even in extreme environments.

2. Specification

Antenna Ultima MA530 MIMO		
MIMO 1		
Operation Frequency (GHz)	2.4~2.5	5.15~5.85
Polarization	Linear	
Impedance (ohms)	50	50
Max Isolation (dB) to other port	-11	-20
Max VSWR	3.0:1	3.0:1
Max Return Loss (dB)	-5	-5
Peak Gain (dBi)	3.5	1.6
Efficiency (%)	39.6	26.5
Average Gain (dB)	-4.0	-5.8
Radiation Properties	Omni	Omni
Max Input Power	5W max	
MIMO 2		
Operation Frequency (GHz)	2.4~2.5	5.15~5.85
Polarization	Linear	
Impedance (ohms)	50	50
Max Isolation (dB) to other port	-11	-20
Max VSWR	3.0:1	3.0:1
Max Return Loss (dB)	-5	-5
Peak Gain (dBi)	5.5	2.3
Efficiency (%)	45.1	26.8
Average Gain (dB)	-3.4	-5.7
Max Input Power	5W max	
MECHANICAL		
Dimensions (mm)	Height=19.6 Diameter=55.23	
Cable	1M RG-174, Fully Customizable	
Casing	PC	
Base and Thread	Plastic	
Weather proof gasket	CR4305 foam with 3M9448B double-side adhesive	
Connector	RP-SMA Male, Fully Customizable	
Thread Diameter (mm)	M24	
Sealant	Rubber Stopper	
Weight	0.06Kg	

ENVIRONMENTAL	
Protection	IP67 & IP69K rated
Temperature Range	40°C to +85°C
Thermal Shock	100 cycles -40 C to +885 C
Humidity	Non-condensing 65 C 95% RH
Shock (Drop Test)	1m drop on concrete 6 axes

* The Ultima MA.530 MIMO antenna performance was measured with RG174 coaxial cable at 1 meter cable length.

Table 1. Detail information of MA530 Antenna Characteristics.

3. Antenna Characteristics

3.1 Test set-up

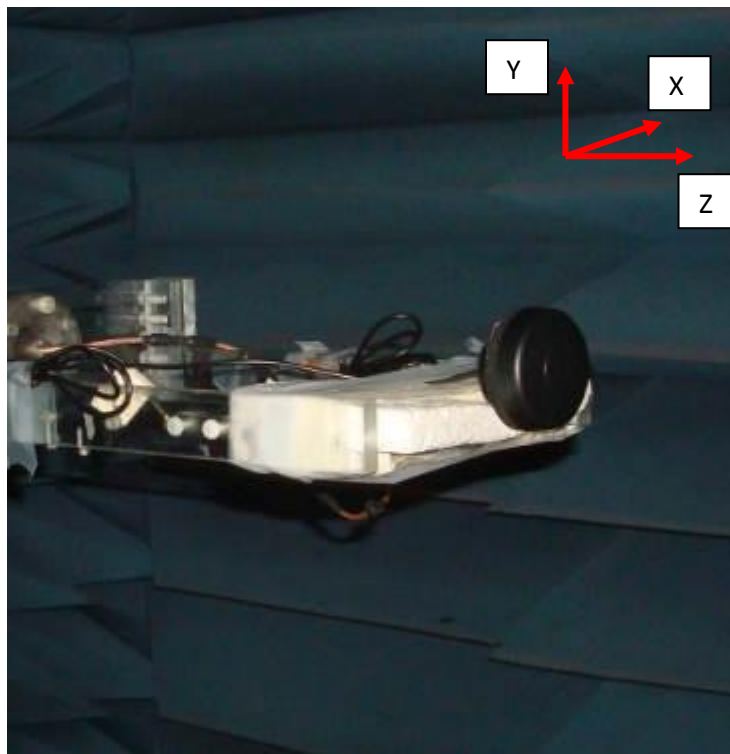

Figure 1. Peak gain, efficiency and radiation pattern measurements.

3.2 Return Loss

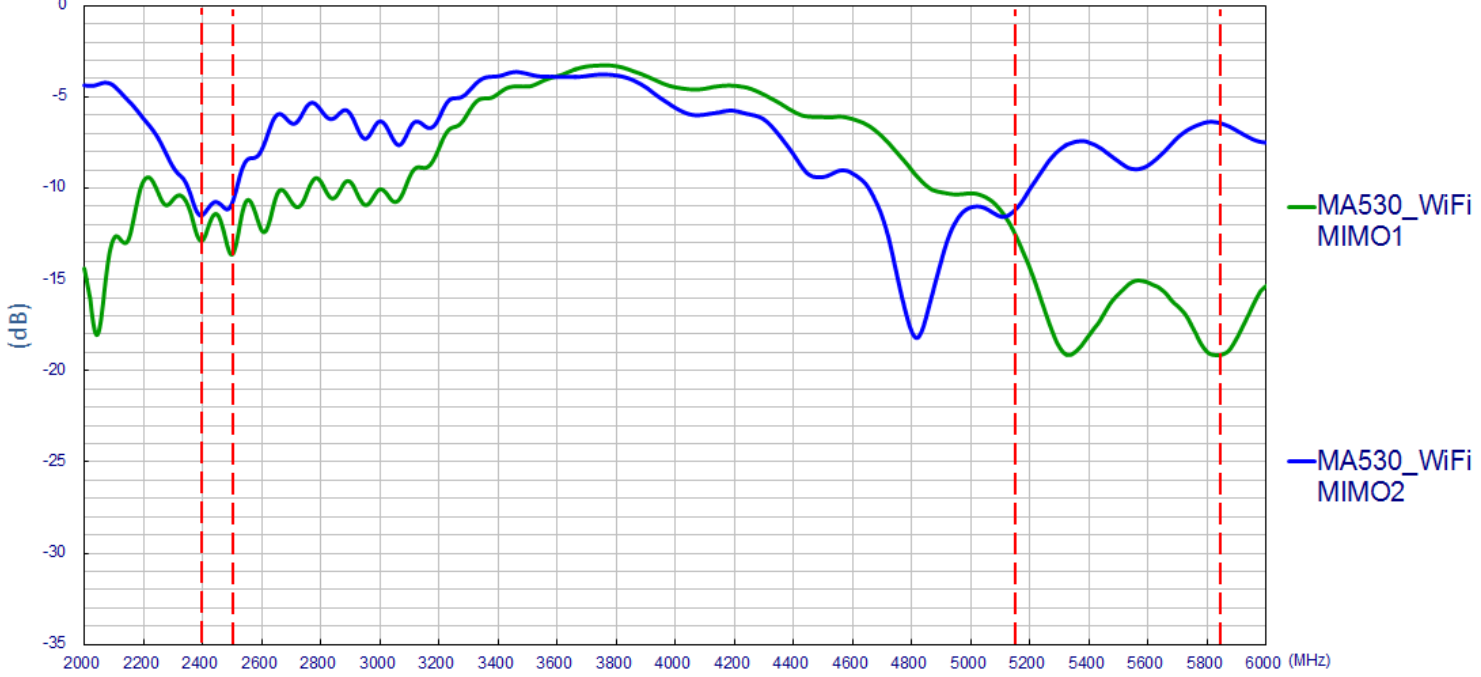

Figure 2. Return loss of the Ultima MA530 MIMO antenna.

3.3 Insertion Loss of Two Ports

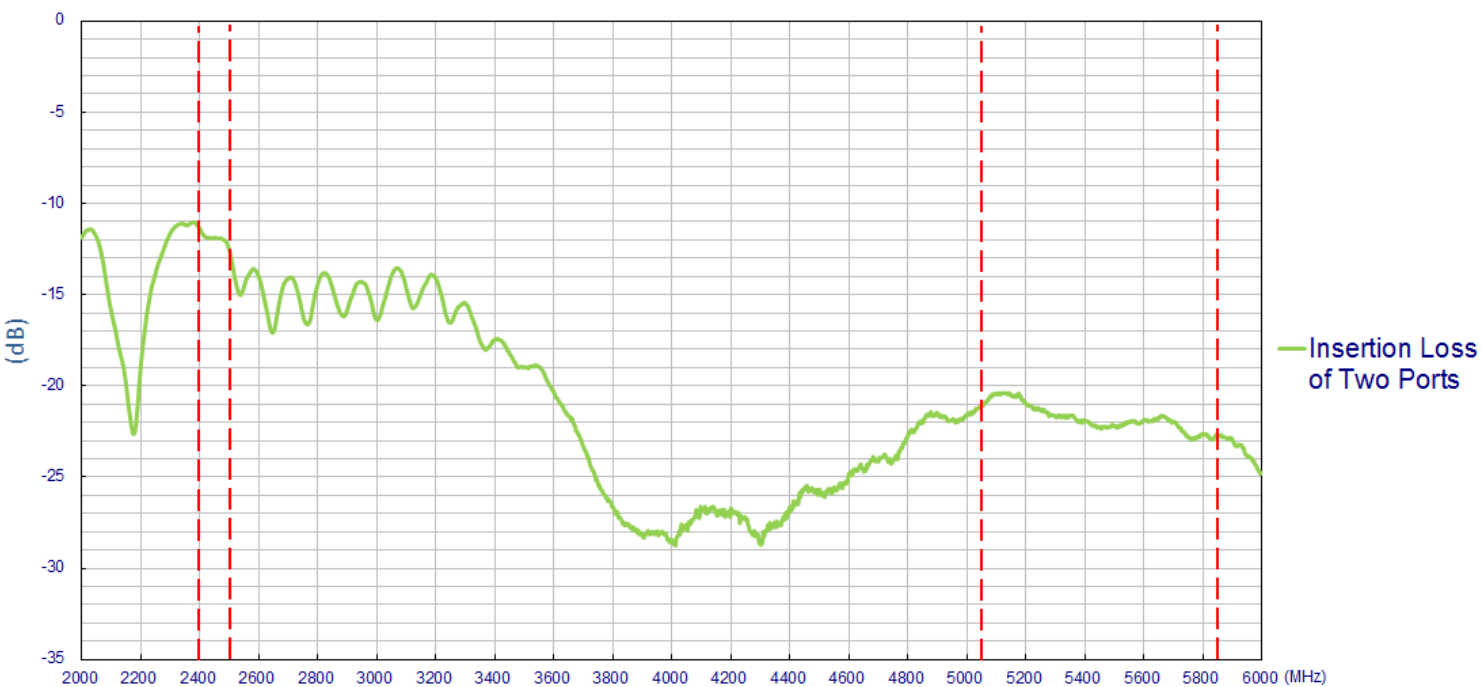

Figure 3. Insertion Loss of the Ultima MA530 MIMO antenna

3.4 Efficiency

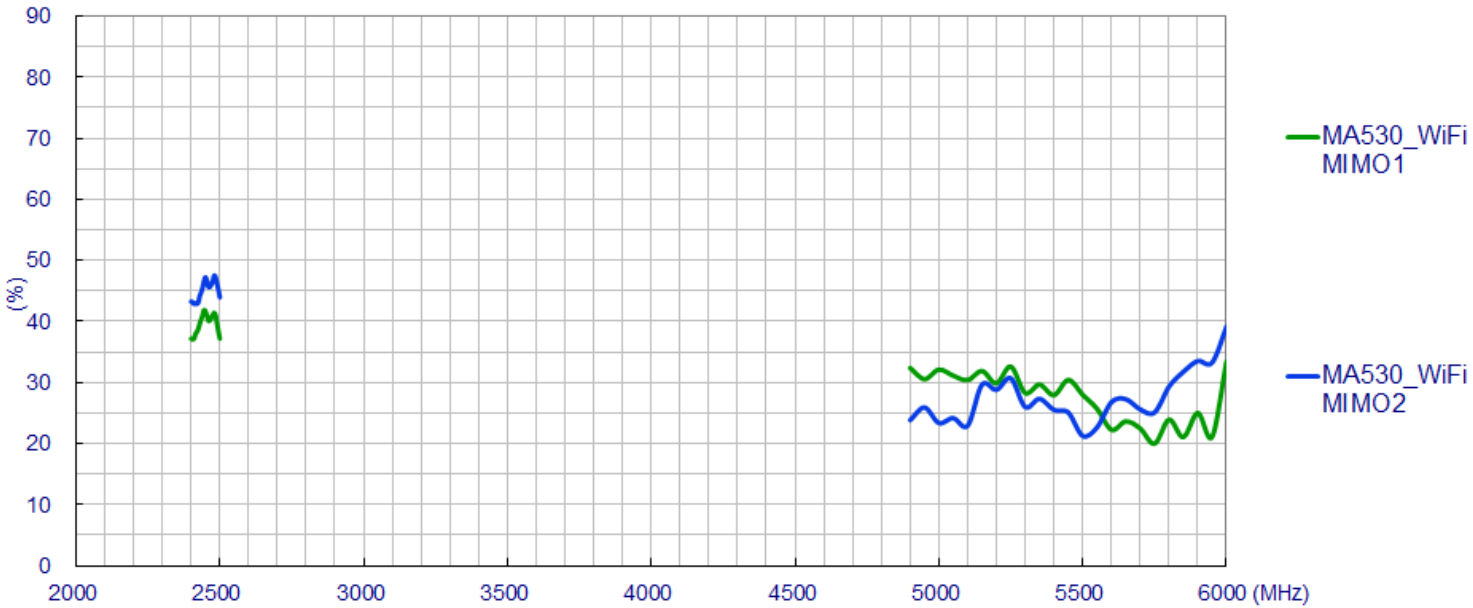

Figure 4. Efficiency of the Ultima MA530 MIMO antenna.

3.5 Peak Gain

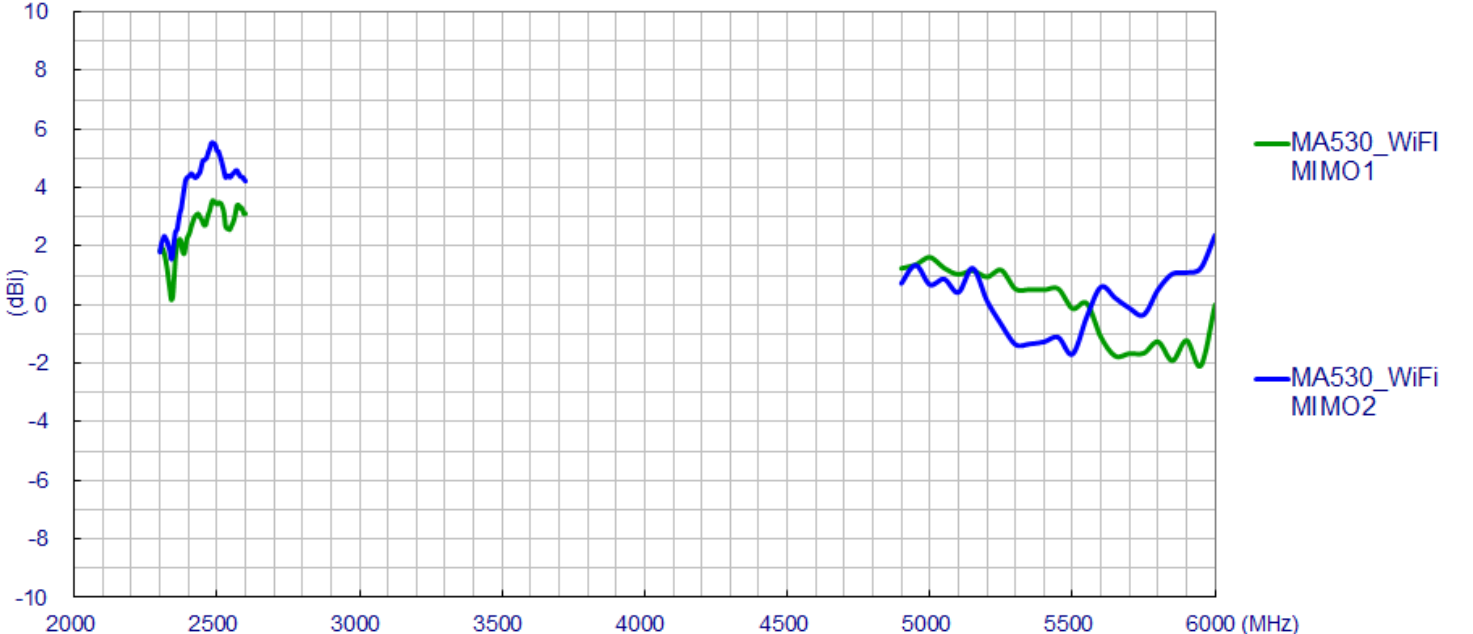

Figure 5. Peak Gain of the Ultima MA530 MIMO antenna.

3.6 Average Gain

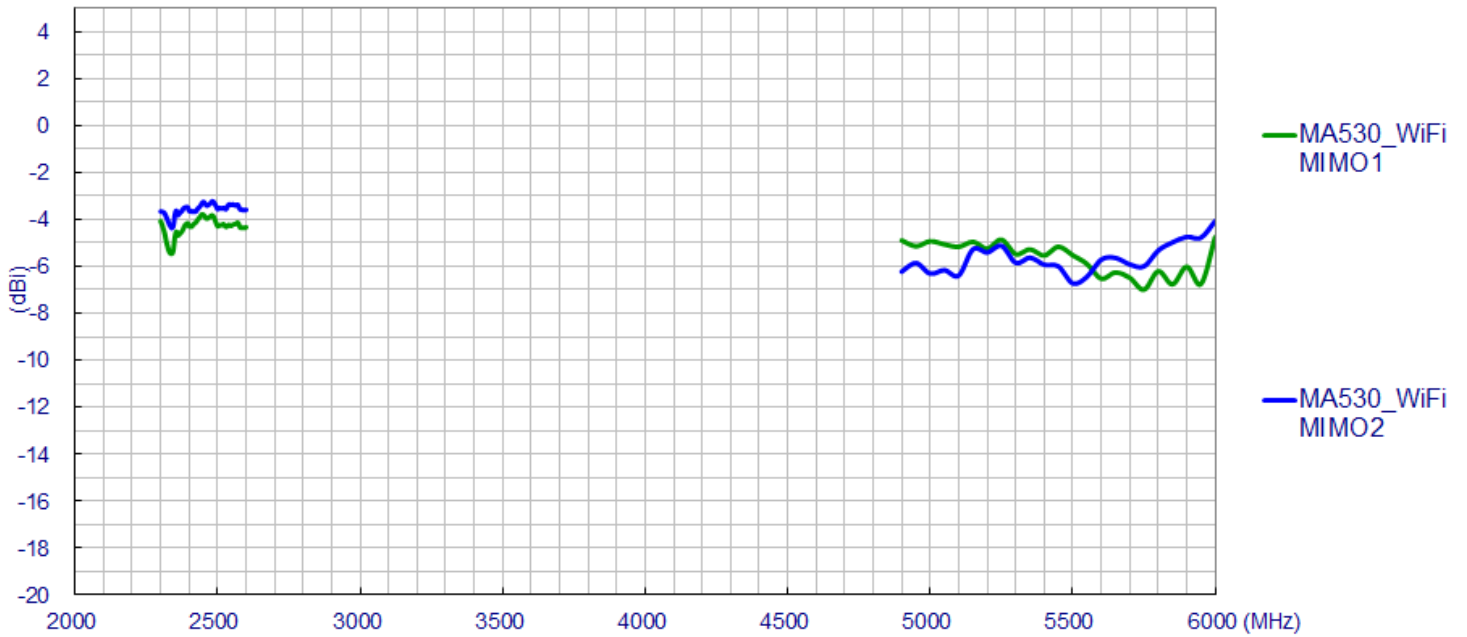
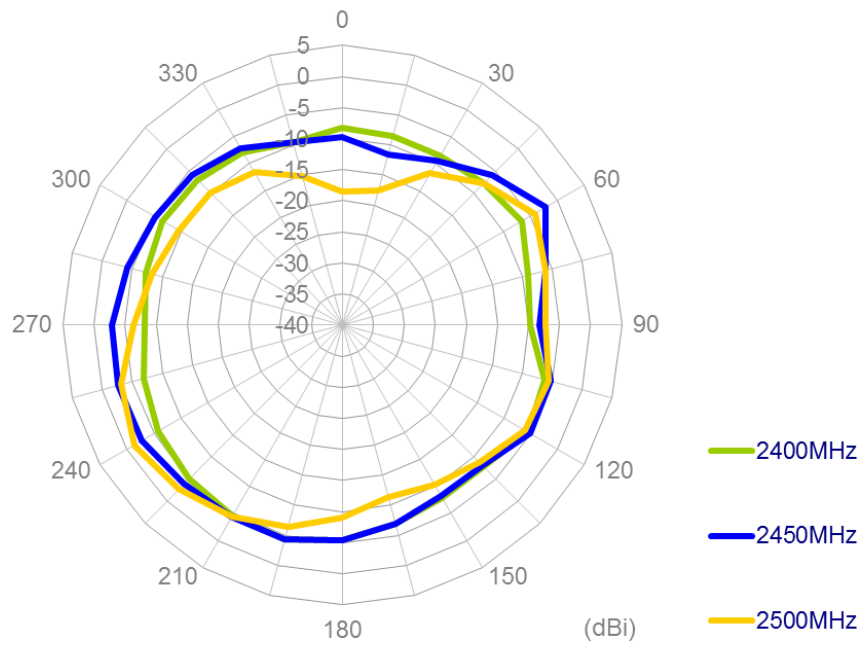

Figure 6. Average Gain of the Ultima MA530 MIMO antenna.

3.7 3D Radiation Patterns

3.7.1 MIMO Antenna 1

XY-Plane



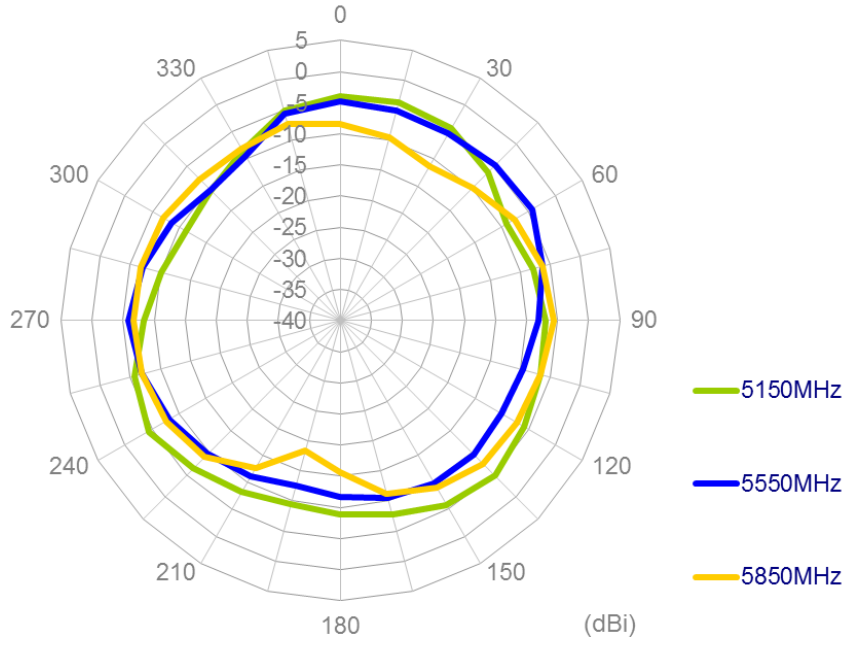

XZ-Plane

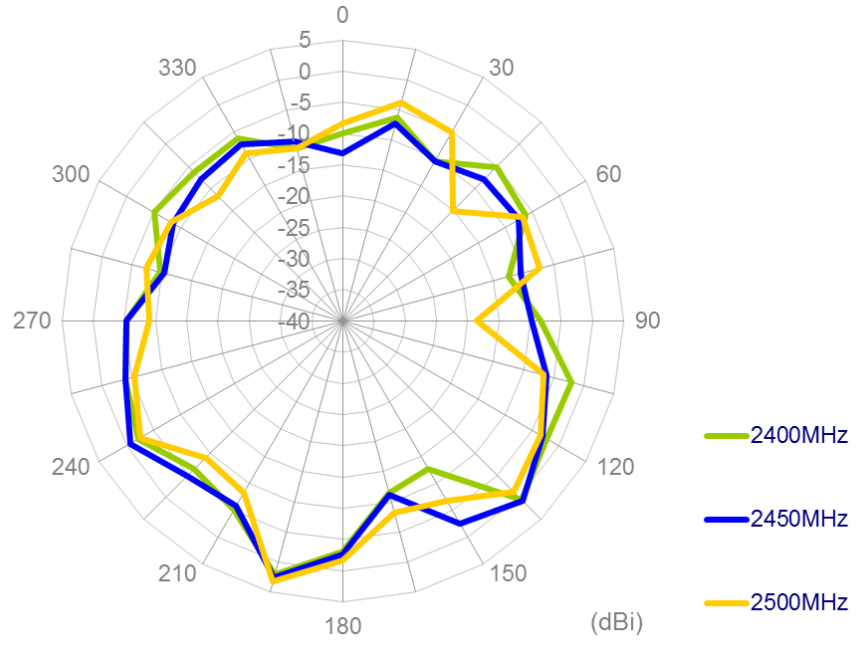

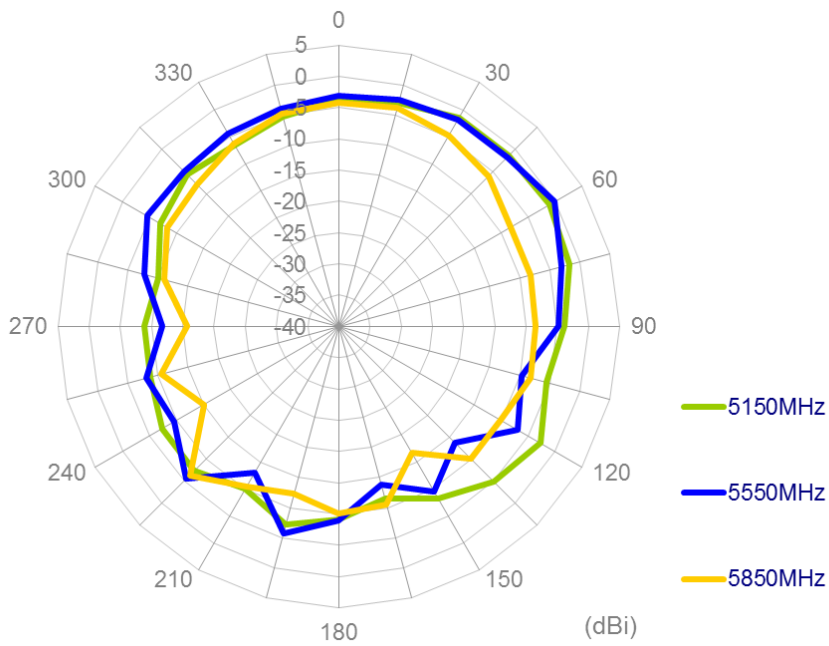

YZ-Plane

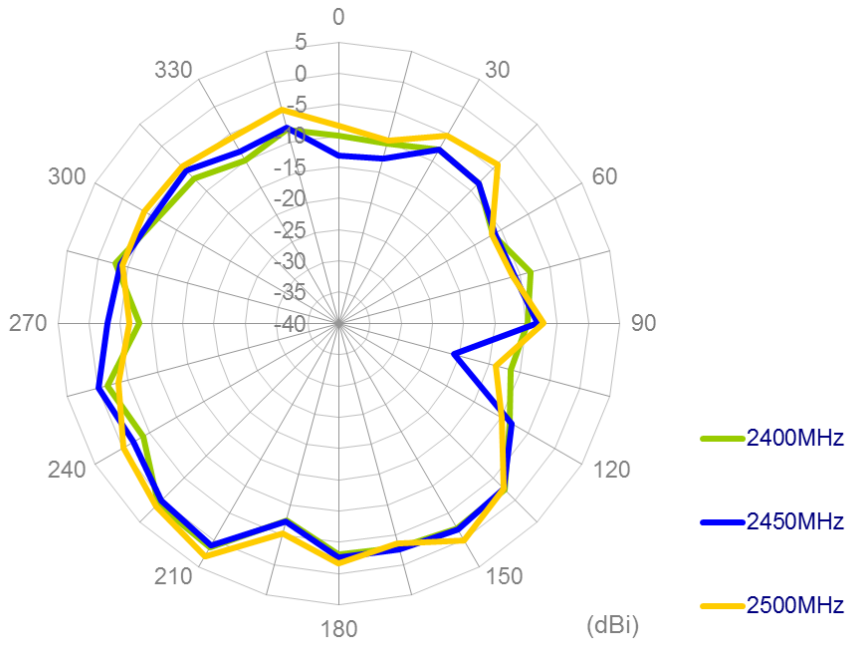

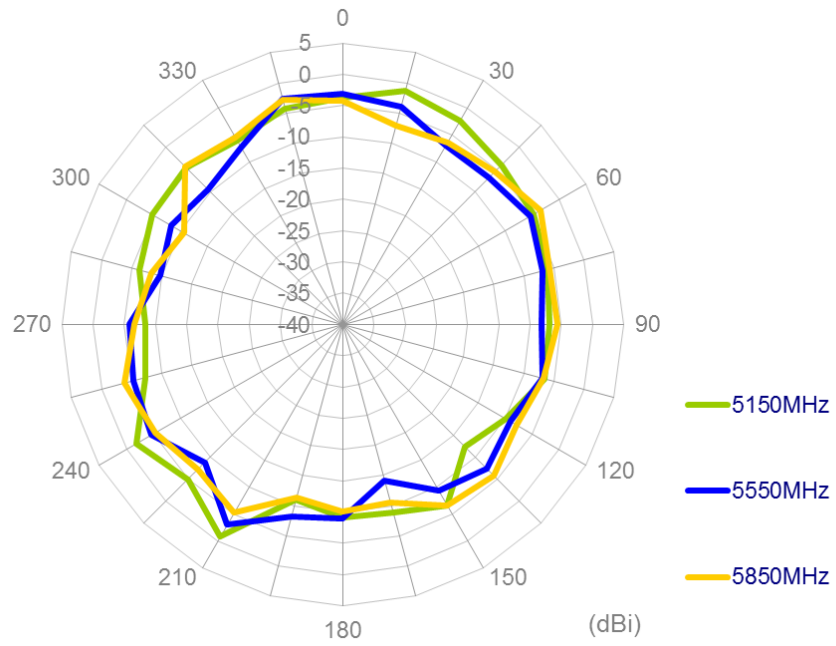
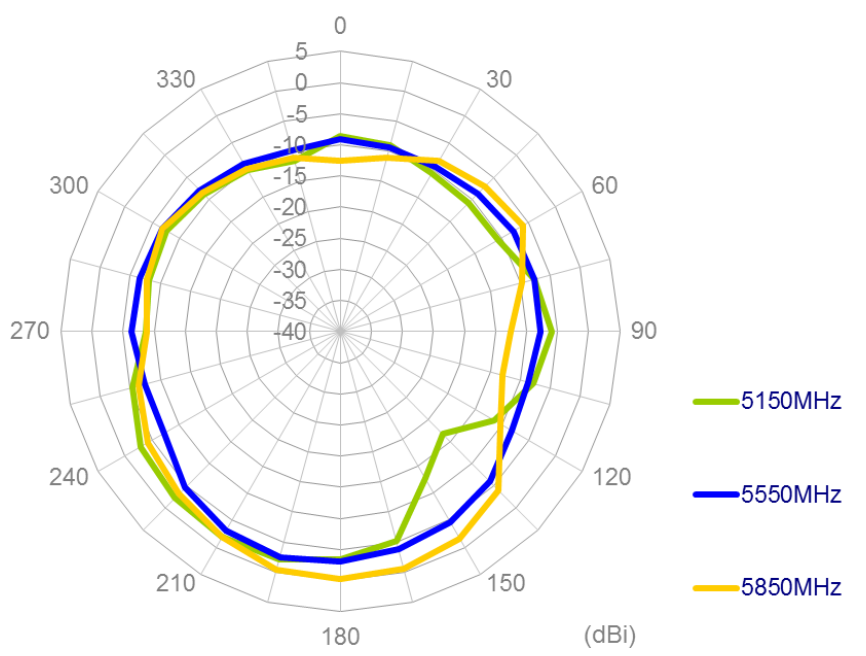
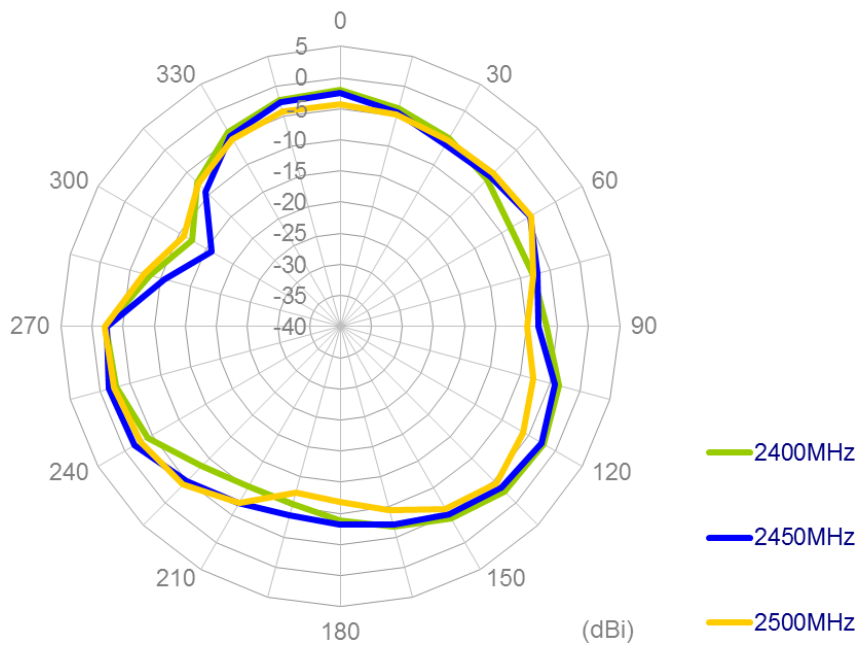

Figure 7. 2D Radiation Pattern of the MA530 MIMO1 Antenna.

3.7.2 MIMO Antenna 2

XY-Plane



XZ-Plane

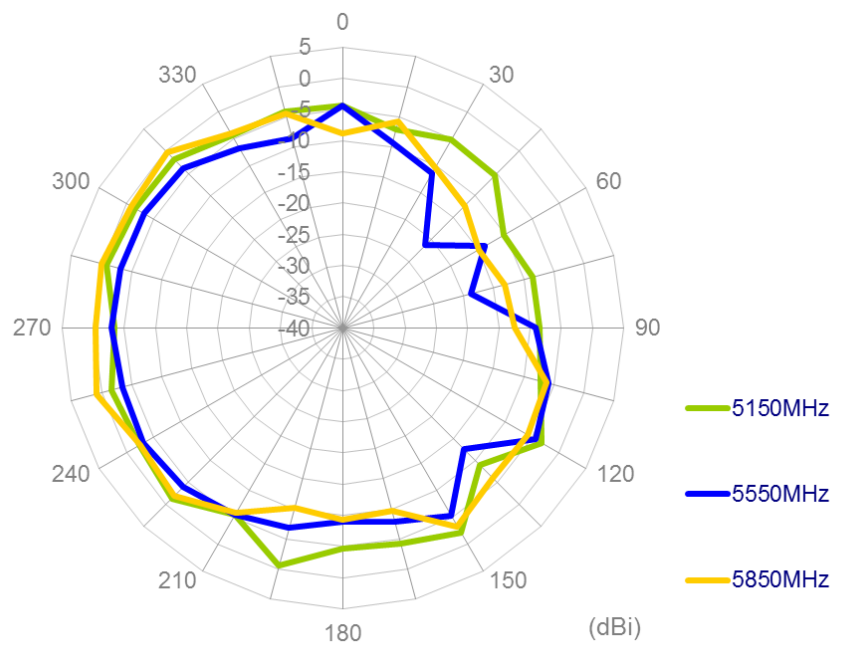
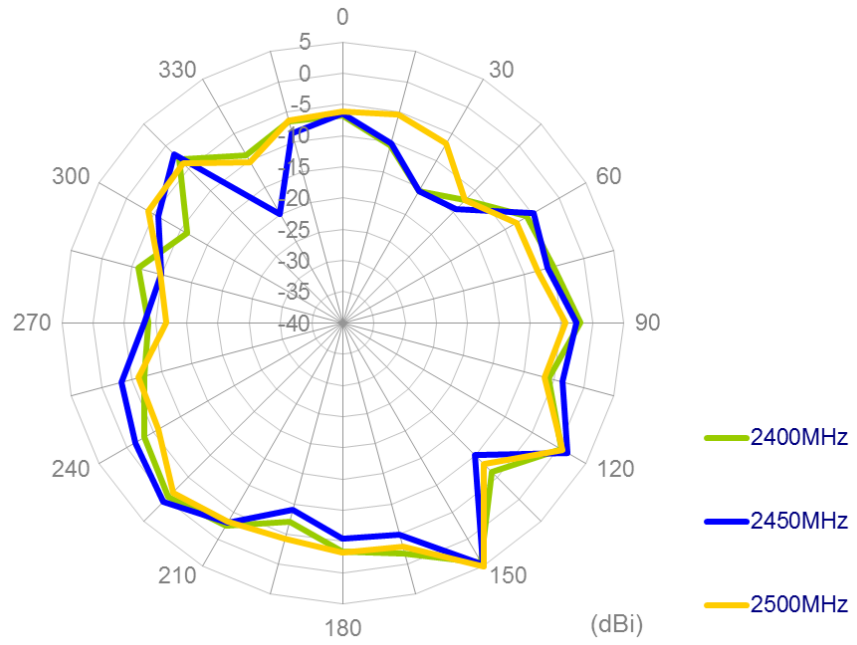

YZ-Plane

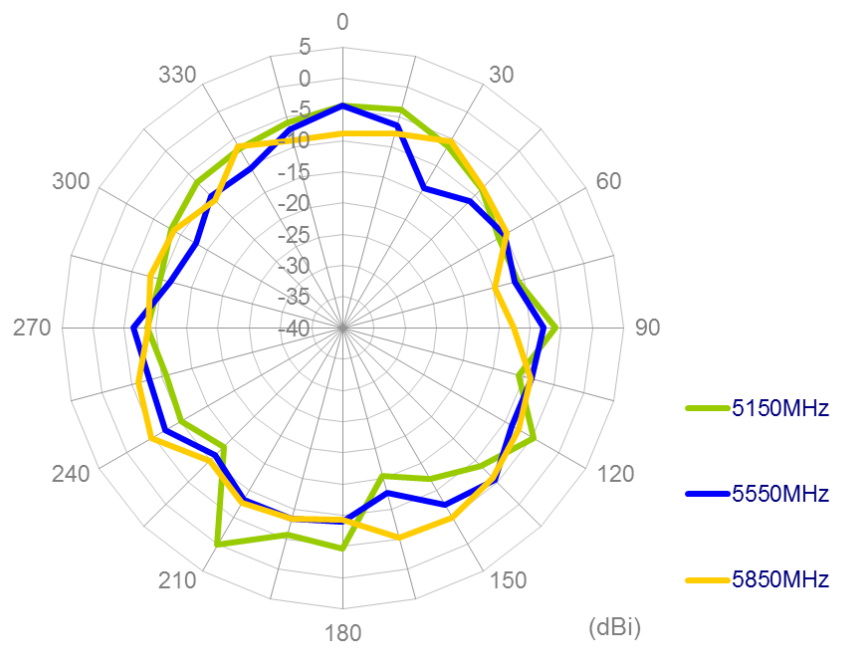
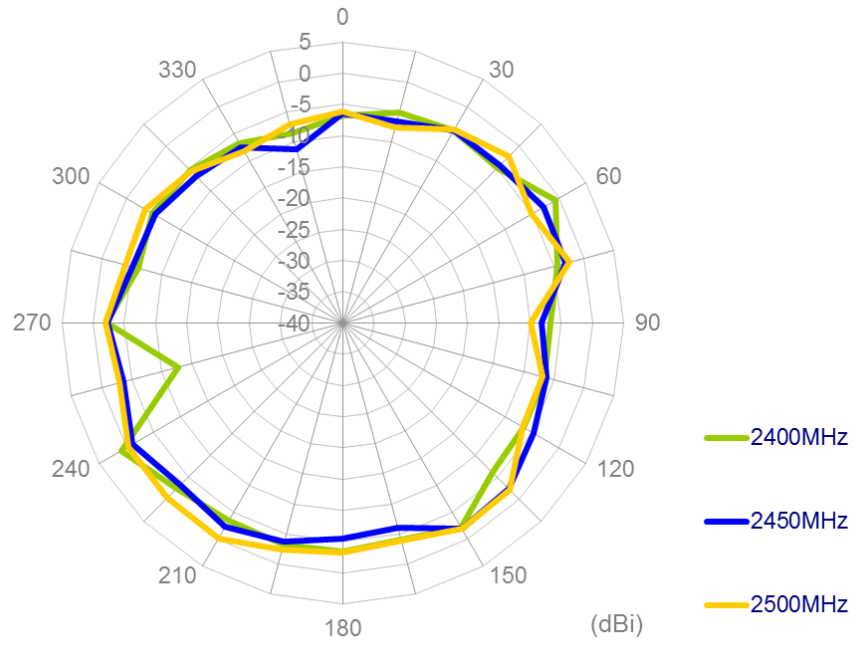

Figure 8. 2D Radiation Pattern of the MA530 MIMO2 Antenna.

4. Antenna Drawing

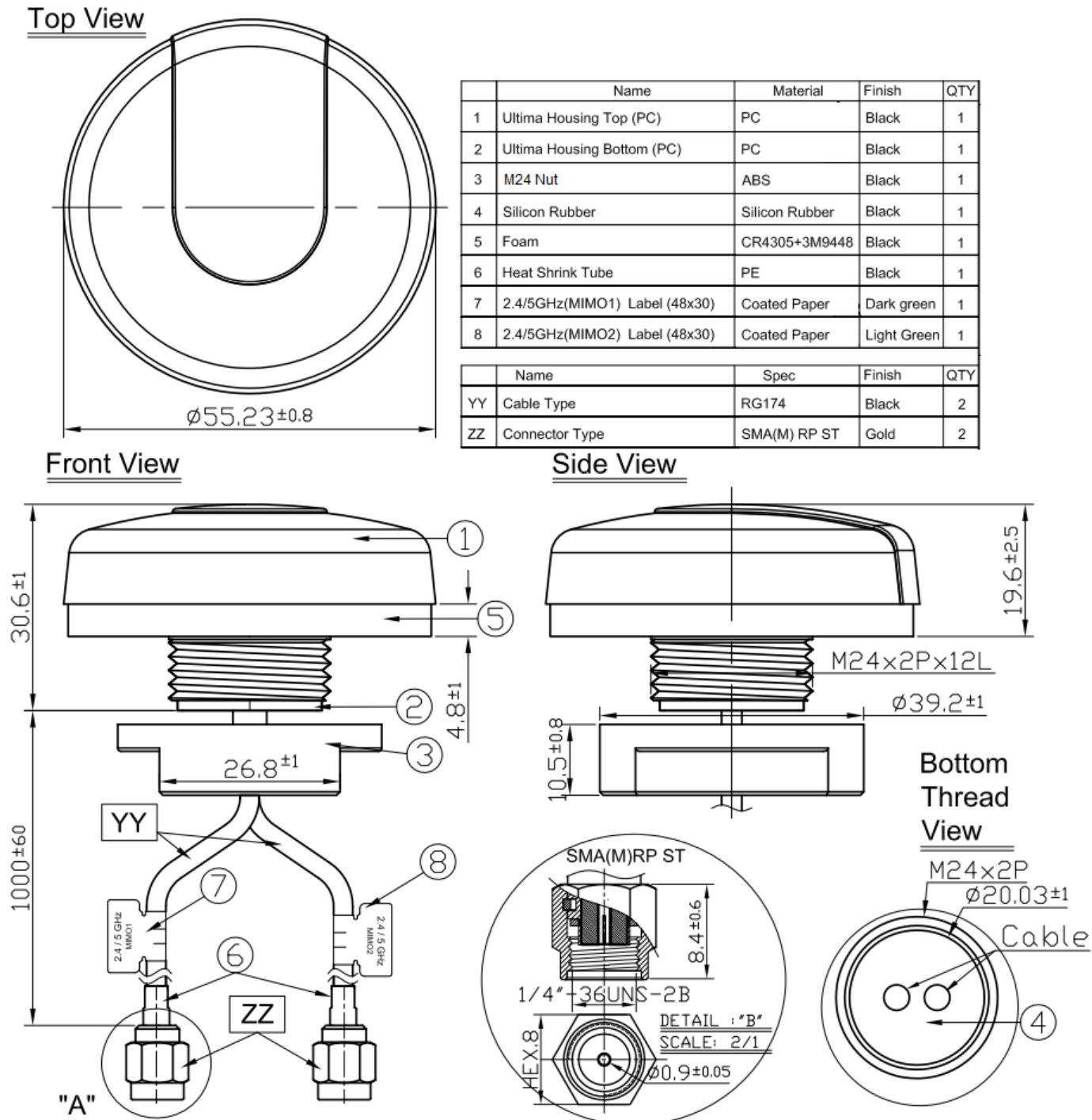
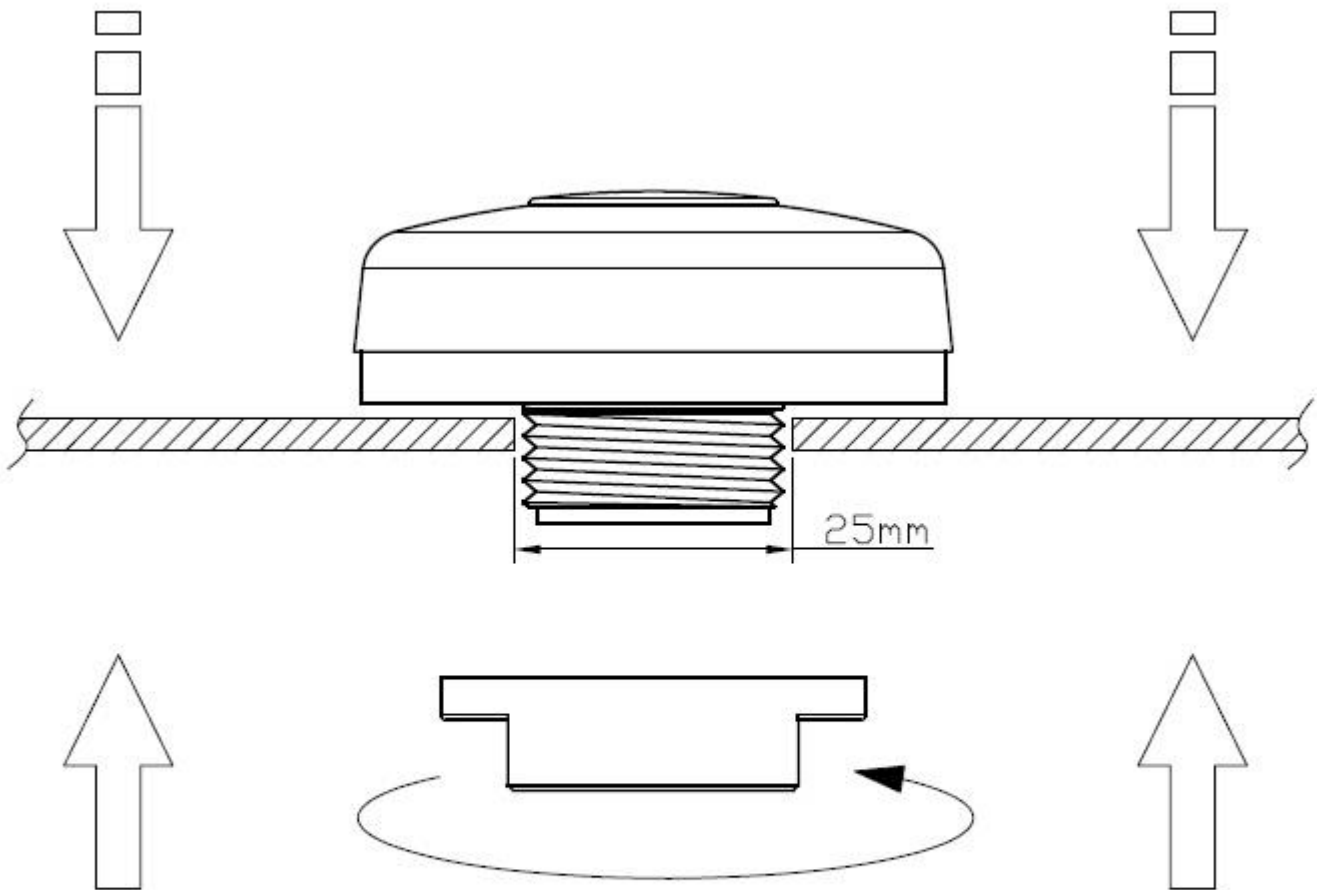

Figure 9. Antenna Drawing

5. Installation



Recommended torque for mounting is 3.92 N·m or 40 kgf.cm

Maximum torque for mounting is 4.9 N·m or 50 kgf.cm

Figure 10. Installation

6. Packaging

- 1 piece MA530 per PE Bag [Weight 0.06kg]
- 100 pieces per carton [Weight 7.2kg]
- 3600 pieces per Pallet [36 Cartons on 1 Pallet (4 layers of 9 Cartons)]

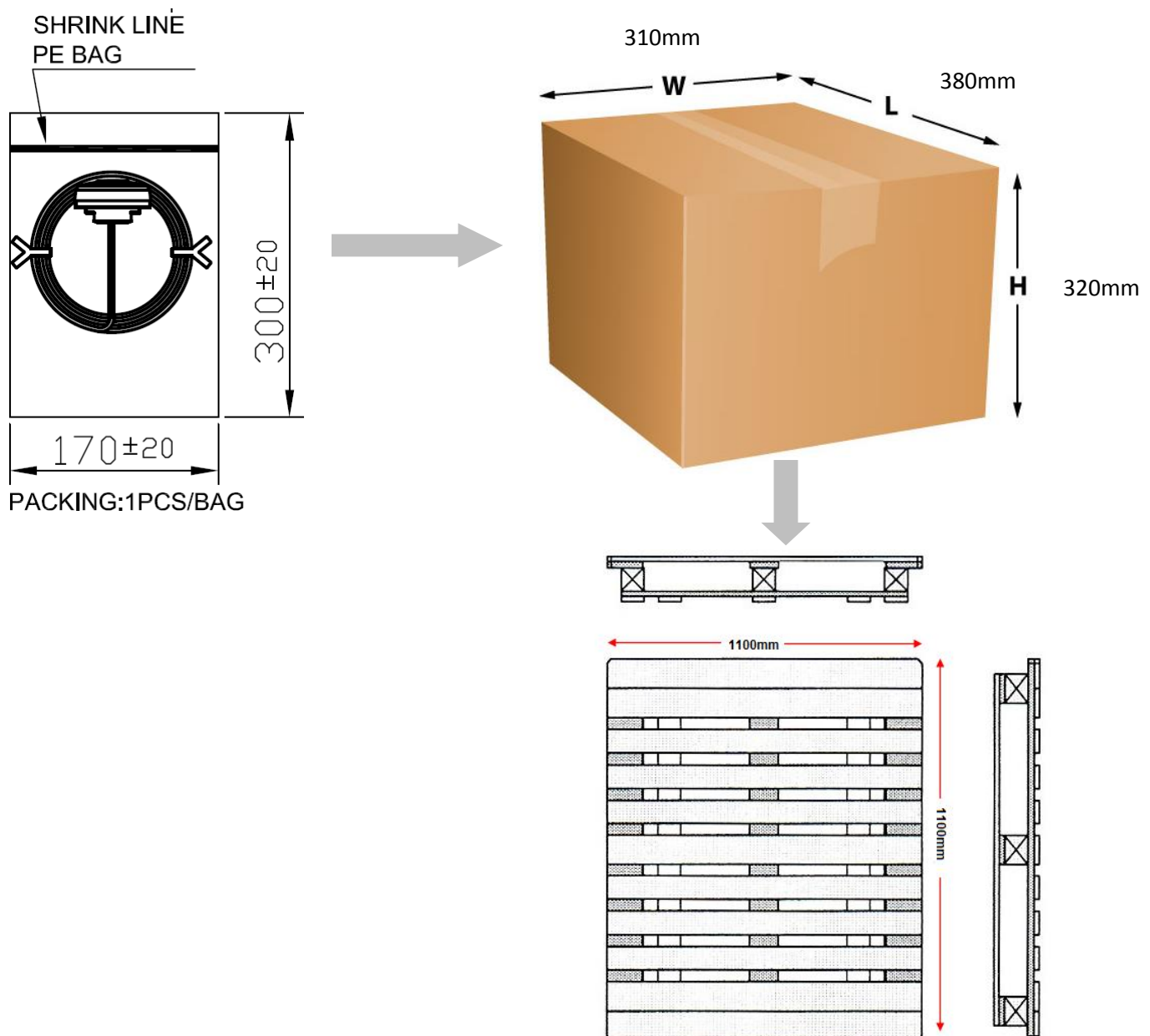

Figure 11. Packaging Info