

Specification

Part No. : **LMA100.A.BI.001**

Product Name : Gemini LTE 4G MIMO 2x2 Antenna for Routers and Access Points

Feature : Best solution for 4G 2x2 Worldwide LTE MIMO applications
Covers fallback 3G/2G frequencies too
(HSPA/UMTS/WCDMA/GSM/GPRS)
698-960MHz,1710-2170MHz,2490-2690MHz
High Efficiency Indoor and Outdoor Antenna
Waterproof IP65
Wall Mount or Desktop Mount
Dimension: 164mm*164mm*36.5mm
2* Low Loss 1M CFD-200 Cables - SMA(M)

RoHS compliant



1. Introduction

The Gemini LTE 4G MIMO 2X2 is a robust external antenna that is fully IP65 waterproof for use with all 4G/3G/2G MIMO cellular routers and Access points worldwide. It includes two embedded high efficiency LTE MIMO antennas. The antenna elements operate at all common and 4G LTE bands worldwide; 698-960MHz, 1710-2170MHz, 2490-2690MHz, which also include the 3G and 2G bands, meaning the antenna can also be used as fallback on 3G or 2G applications. High isolation and low ECC between the two embedded MIMO antennas prevents self-interference. Low loss cables are used to keep efficiency high over long cable lengths up to 5 meters.

This unique antenna offers two methods for easy installation, both indoors and outdoors. A bracket on the back of the antenna enables easy wall installation, keeping your work area clean and spacious. The antenna can also be placed on a flat surface using the stand holder for easy and quick installation.

Typical Applications:

- HD Real-time Streaming Video over LTE
- Intelligent Transport Systems
- Internet of Things (IoT market)
- Digital Signage
- HD Broadcast Systems
- Wireless 4G LTE MIMO M2M devices with legacy 3G Functionality

Cable length and connector types are customizable. Contact your regional Taoglas sales office for support.

2. Specification Table

4G/3G/2G MIMO1 Antenna								
Frequency (MHz)		LTE700	GSM850	GSM900	DCS	PCS	UMTS1	LTE2600
		698~824	824~894	880~960	1710~1880	1850~1990	1920~2170	2490~2690
Efficiency (%)								
MIMO1	0.3M	77.91	57.40	46.79	66.09	61.53	43.94	41.33
	1M	74.40	54.82	44.68	60.27	56.20	40.36	37.70
	2M	66.31	48.59	38.91	49.44	45.76	32.97	29.63
	3M	61.89	45.06	36.11	43.76	40.32	28.84	25.17
	5M	53.13	37.96	30.30	34.20	31.13	22.32	19.24
MIMO2	0.3M	73.17	46.21	37.12	71.80	59.28	45.79	45.25
	1M	69.88	44.13	35.45	65.48	54.17	42.14	41.27
	2M	62.28	39.09	30.87	53.75	44.11	34.45	32.49
	3M	58.12	36.23	28.63	47.54	38.89	30.14	27.63
	5M	49.90	30.55	24.07	37.19	30.01	23.33	21.11
Average Gain (dBi)								
MIMO1	0.3M	-1.12	-2.46	-3.32	-1.83	-2.20	-3.82	-3.92
	1M	-1.32	-2.66	-3.52	-2.23	-2.59	-4.18	-4.32
	2M	-1.82	-3.18	-4.12	-3.09	-3.48	-5.06	-5.36
	3M	-2.12	-3.51	-4.45	-3.62	-4.04	-5.64	-6.07
	5M	-2.79	-4.26	-5.20	-4.69	-5.16	-6.75	-7.23
MIMO2	0.3M	-1.42	-3.36	-4.35	-1.45	-2.37	-3.55	-3.48
	1M	-1.62	-3.56	-4.55	-1.85	-2.76	-3.91	-3.88
	2M	-2.12	-4.09	-5.15	-2.71	-3.65	-4.78	-4.92
	3M	-2.42	-4.42	-5.48	-3.24	-4.21	-5.37	-5.63
	5M	-3.08	-5.16	-6.23	-4.31	-5.33	-6.47	-6.80

Peak Gain (dBi)								
MIMO1	0.3M	4.76	3.42	3.07	4.68	4.68	4.20	2.41
	1M	4.56	3.22	2.87	4.28	4.28	3.80	2.01
	2M	4.06	2.72	2.27	3.38	3.38	2.90	1.01
	3M	3.76	2.42	1.97	2.88	2.88	2.30	0.31
	5M	3.16	1.62	1.17	1.78	1.78	1.20	-0.89
MIMO2	0.3M	4.62	2.94	2.89	5.04	5.12	5.08	2.20
	1M	4.42	2.74	2.69	4.64	4.72	4.68	1.80
	2M	3.92	2.24	2.09	3.74	3.82	3.78	0.80
	3M	3.62	1.84	1.79	3.24	3.32	3.28	0.10
	5M	3.02	1.14	1.09	2.14	3.32	2.08	-1.00
Impedance	50 Ω							
Polarization	Vertical							

MECHANICAL	
Casing	PC+ABS
Coaxial Cable	CFD-200
Cable Length	1 Meter Standard, Fully Customizable
Connector	SMA Male Standard, Fully Customizable
Waterproof	IP65
Weight	400 g (Antenna with 1 meter Cable and Stand)
Dimension	164mm*164mm*36.5mm
ENVIRONMENTAL	
Operation Temperature	-40°C to 85°C
Storage Temperature	-40°C to 85°C
Humidity	Non-condensing 65°C 95% RH

LTE BANDS				
Band Number	LTE / LTE-Advanced / WCDMA / HSPA / HSPA+ / TD-SCDMA			
	Uplink	Downlink	MIMO 1	MIMO 2
1	UL: 1920 to 1980	DL: 2110 to 2170	✓	✓
2	UL: 1850 to 1910	DL: 1930 to 1990	✓	✓
3	UL: 1710 to 1785	DL: 1805 to 1880	✓	✓
4	UL: 1710 to 1755	DL: 2110 to 2155	✓	✓
5	UL: 824 to 849	DL: 869 to 894	✓	✓
7	UL: 2500 to 2570	DL: 2620 to 2690	✓	✓
8	UL: 880 to 915	DL: 925 to 960	✓	✓
9	UL: 1749.9 to 1784.9	DL: 1844.9 to 1879.9	✓	✓
11	UL: 1427.9 to 1447.9	DL: 1475.9 to 1495.9	✗	✗
12	UL: 699 to 716	DL: 729 to 746	✓	✓
13	UL: 777 to 787	DL: 746 to 756	✓	✓
14	UL: 788 to 798	DL: 758 to 768	✓	✓
17	UL: 704 to 716	DL: 734 to 746 (LTE only)	✓	✓
18	UL: 815 to 830	DL: 860 to 875 (LTE only)	✓	✓
19	UL: 830 to 845	DL: 875 to 890	✓	✓
20	UL: 832 to 862	DL: 791 to 821	✓	✓
21	UL: 1447.9 to 1462.9	DL: 1495.9 to 1510.9	✗	✗
22	UL: 3410 to 3490	DL: 3510 to 3590	✗	✗
23	UL: 2000 to 2020	DL: 2180 to 2200 (LTE only)	✓	✓
24	UL: 1625.5 to 1660.5	DL: 1525 to 1559 (LTE only)	✗	✗
25	UL: 1850 to 1915	DL: 1930 to 1995	✓	✓
26	UL: 814 to 849	DL: 859 to 894	✓	✓
27	UL: 807 to 824	DL: 852 to 869 (LTE only)	✓	✓
28	UL: 703 to 748	DL: 758 to 803 (LTE only)	✓	✓
29	UL: -	DL: 717 to 728 (LTE only)	✓	✓
30	UL: 2305 to 2315	DL: 2350 to 2360 (LTE only)	✓	✓
31	UL: 452.5 to 457.5	DL: 462.5 to 467.5 (LTE only)	✗	✗
32	UL: -	DL: 1452 - 1496	✗	✗
35		1850 to 1910	✓	✓
38		2570 to 2620	✓	✓
39		1880 to 1920	✓	✓
40		2300 to 2400	✓	✓
41		2496 to 2690	✓	✓
42		3400 to 3600	✗	✗
43		3600 to 3800	✗	✗

*Covered bands represent an efficiency greater than 20%

3. Antenna Characteristics

3.1. Return Loss

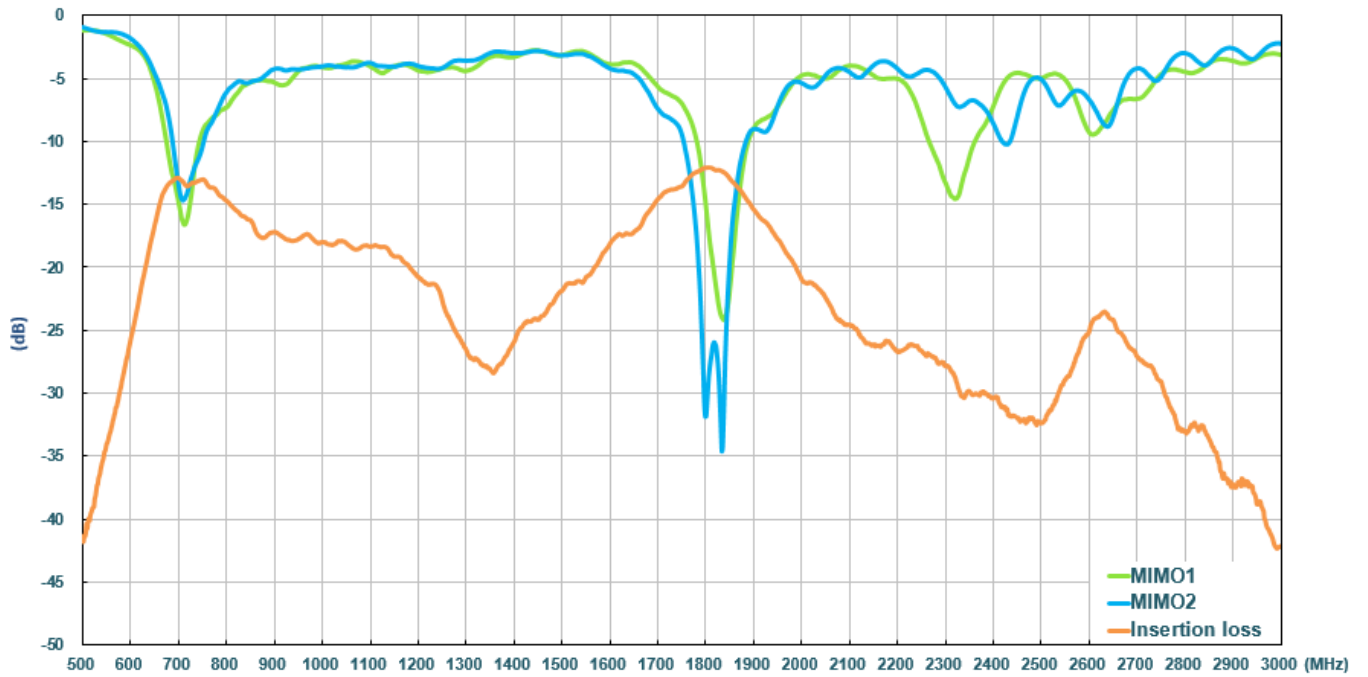

3.2. Efficiency

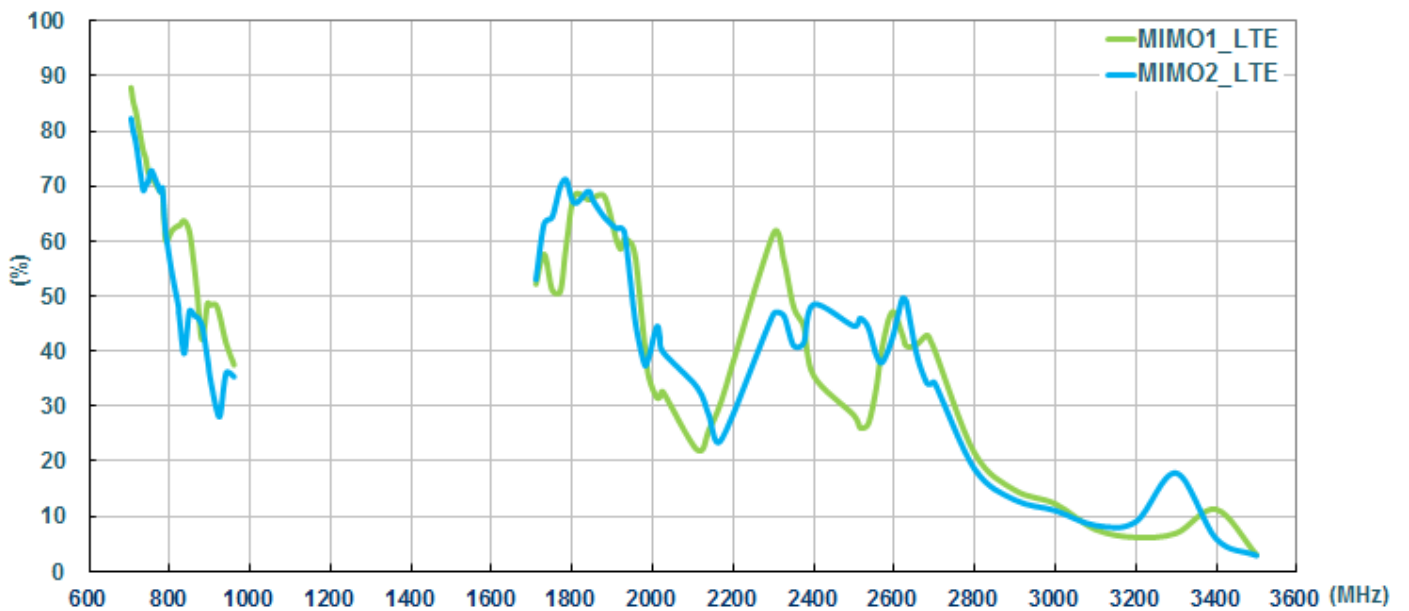

3.3. Average Gain

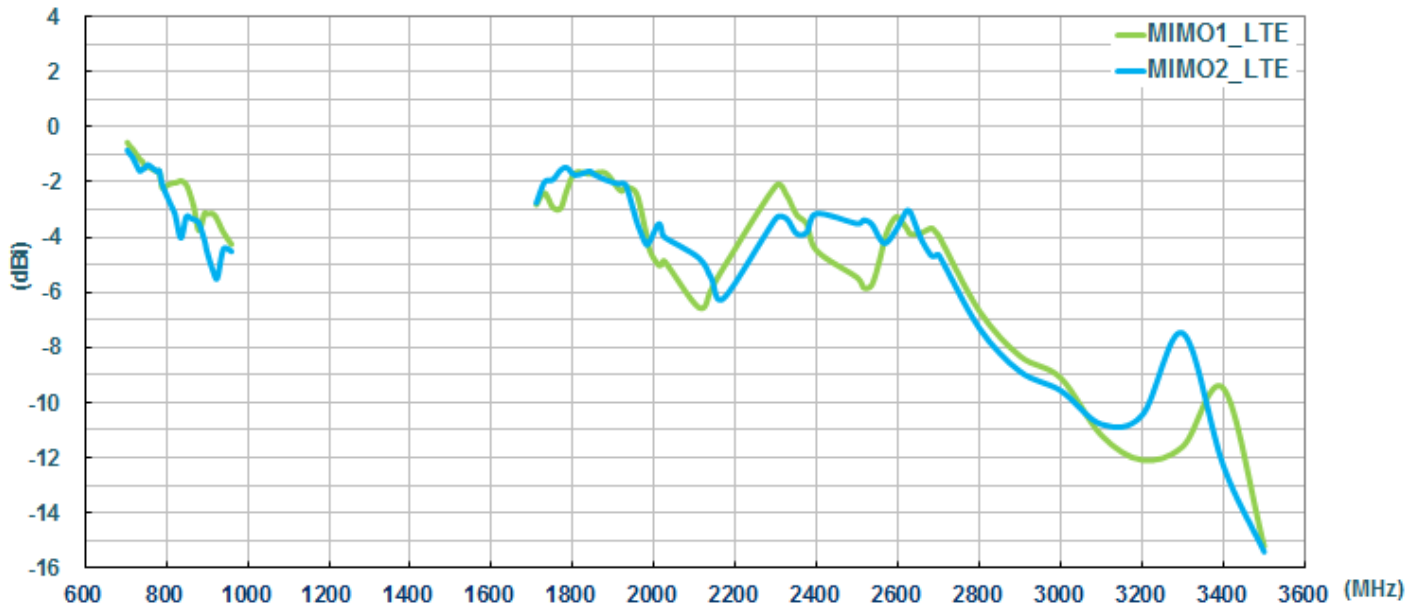

3.4. Peak Gain

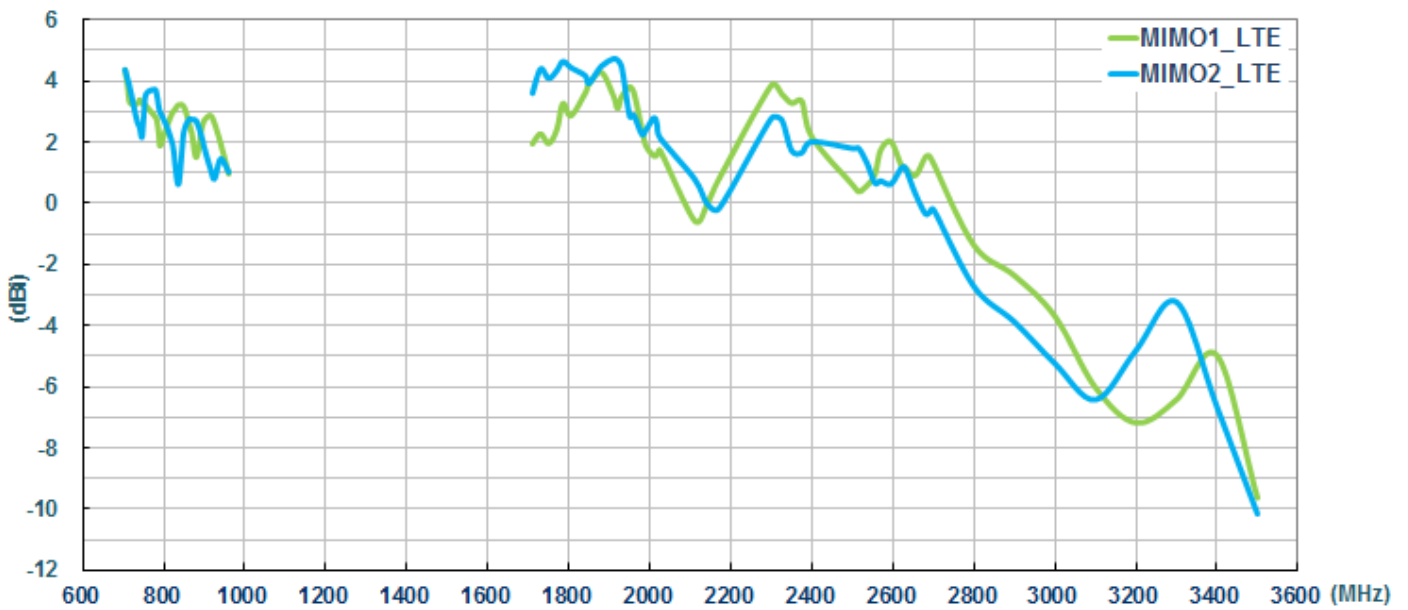

4. Radiation Patterns

4.1. Test Setup

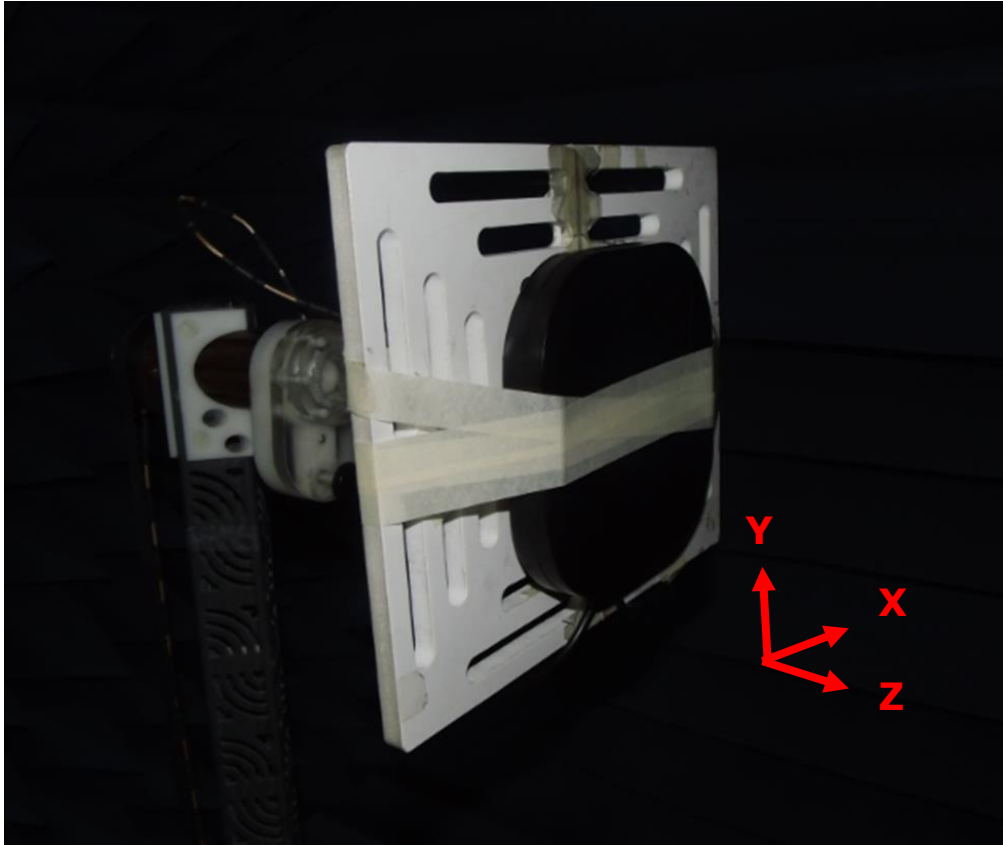

4.2. LTE MIMO1 (2D Radiation Pattern)

XY Plane

XZ Plane

YZ Plane

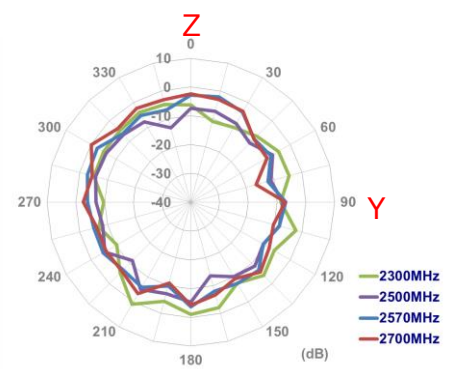
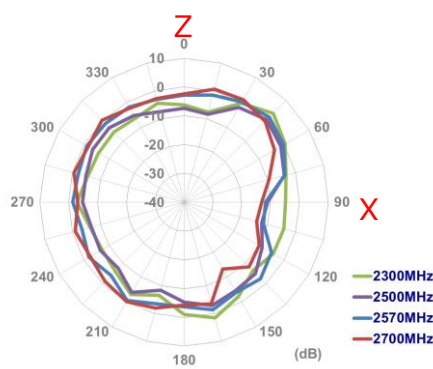
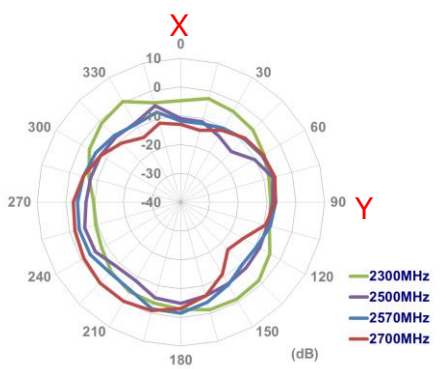
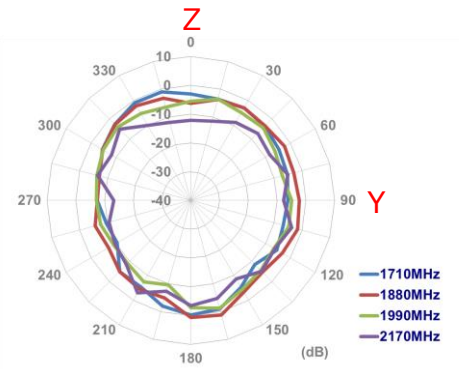
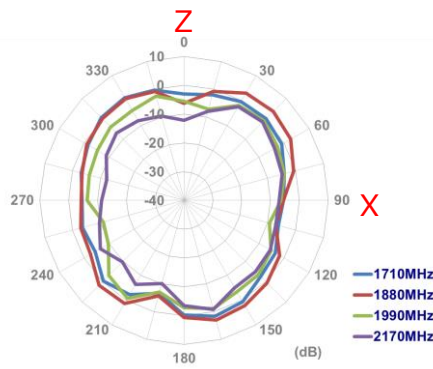
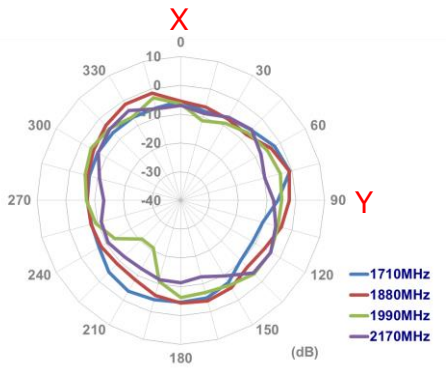
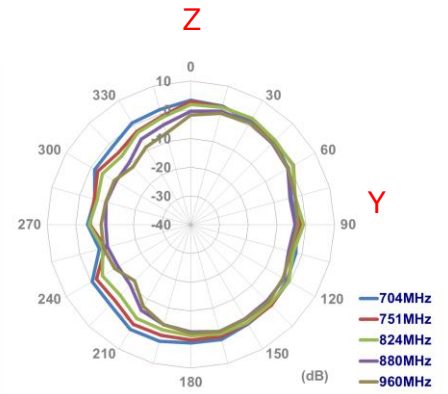
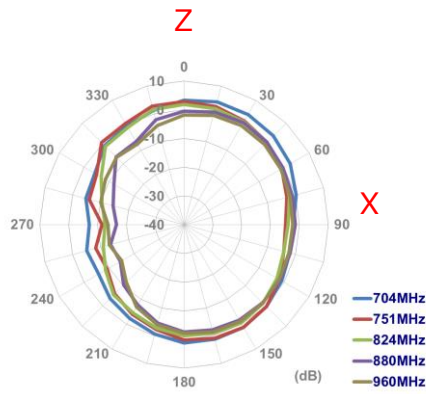
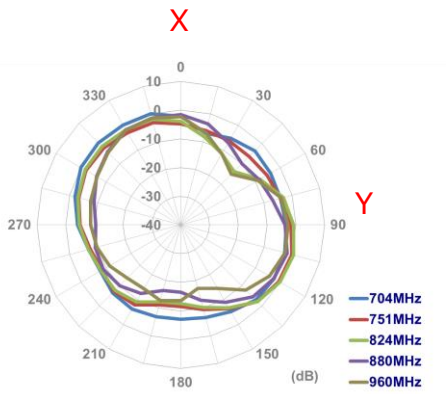



4.3. LTE MIMO 1 (3D Radiation Pattern)

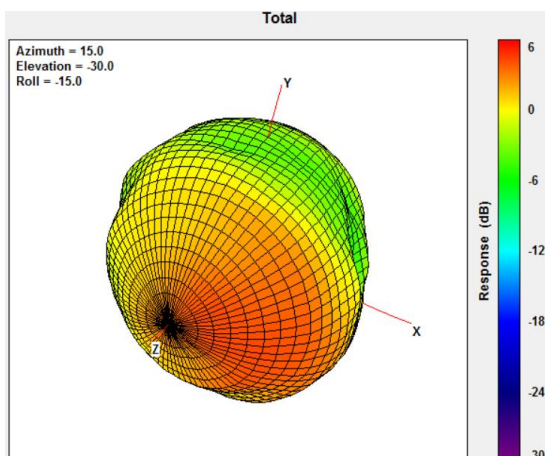

704MHz

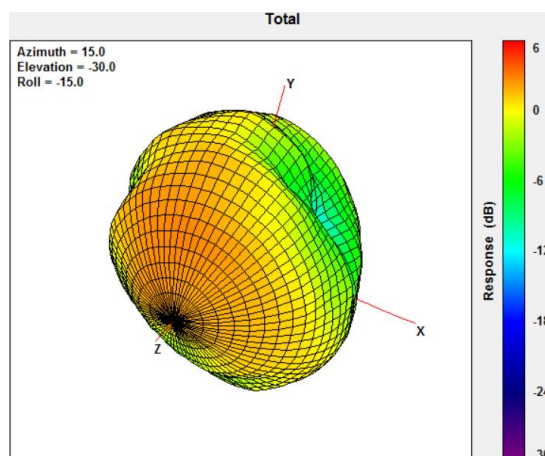

824MHz

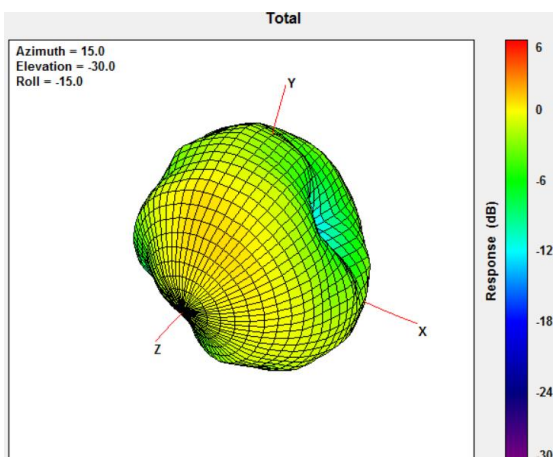

960MHz

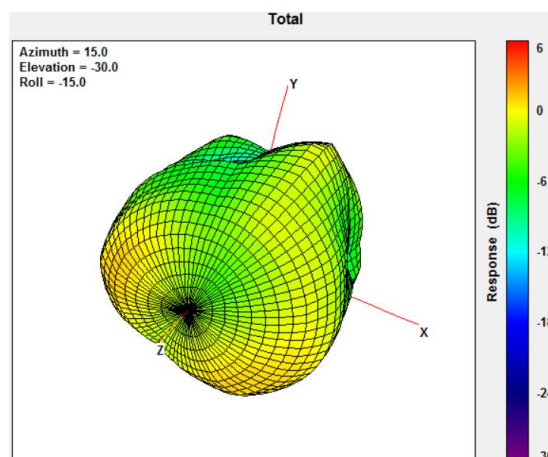

1710MHz

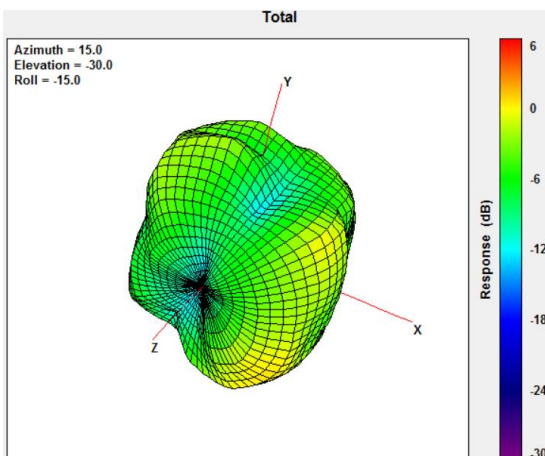

2170MHz

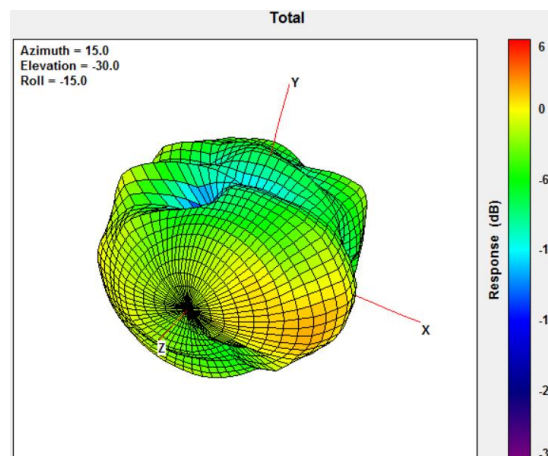

2600MHz

4.4. LTE MIMO2 (2D Radiation Pattern)

XY Plane

XZ Plane

YZ Plane

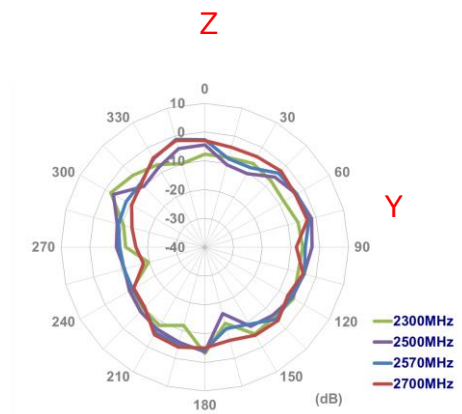
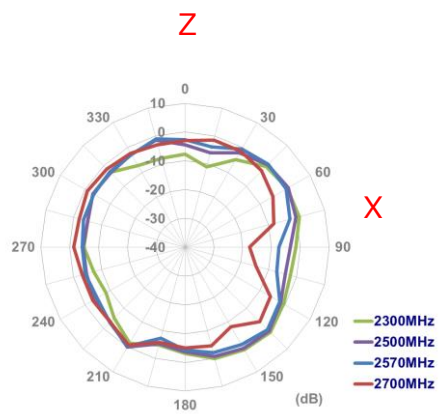
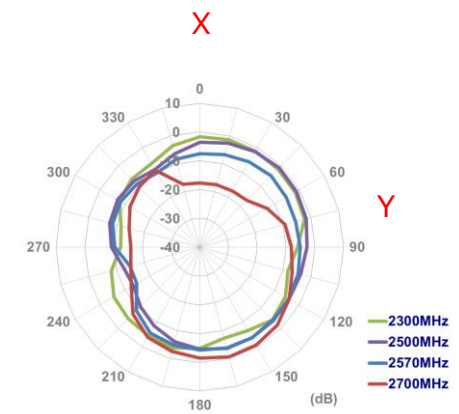
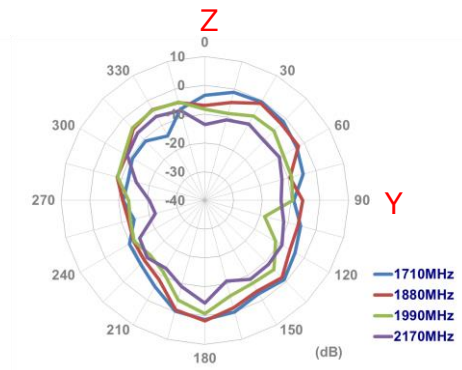
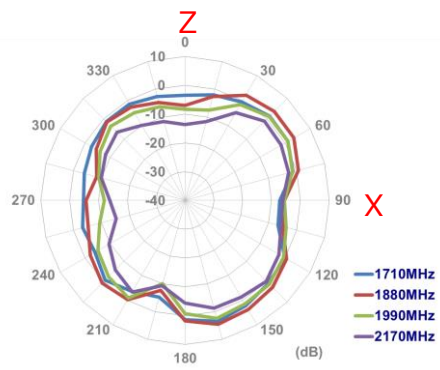
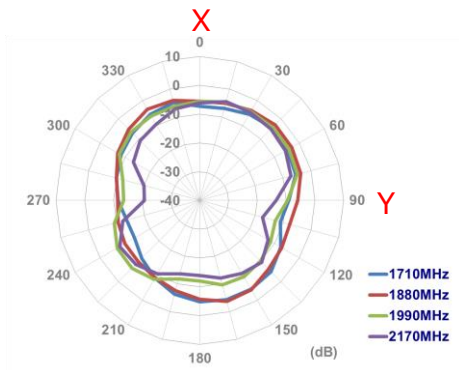
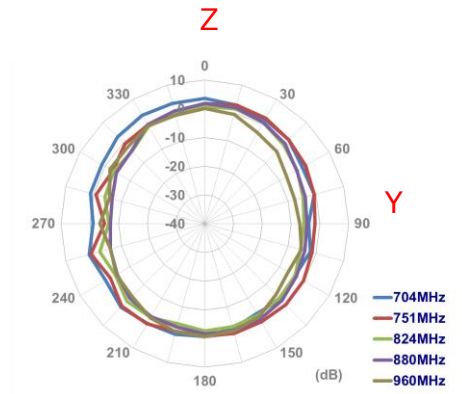
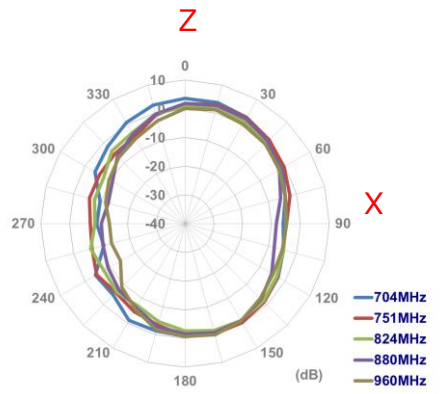
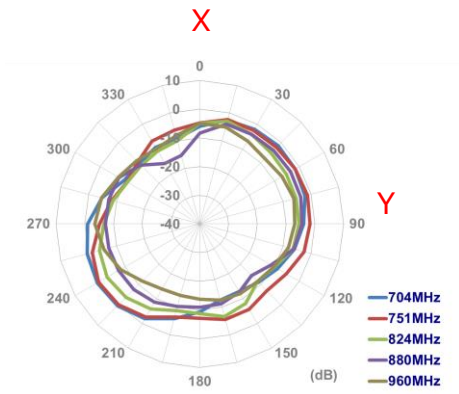



4.5. LTE MIMO 2 (3D Radiation Pattern)

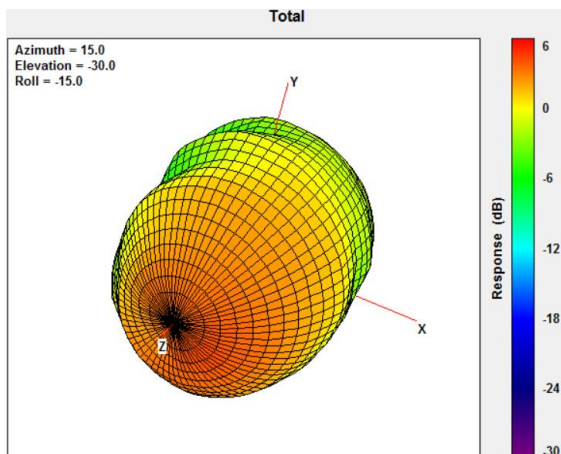

704MHz

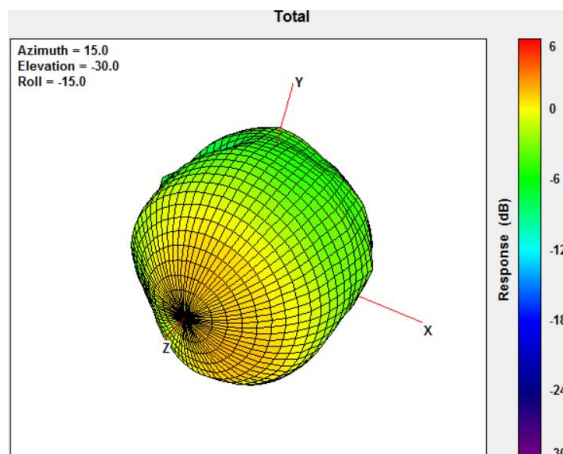

824MHz

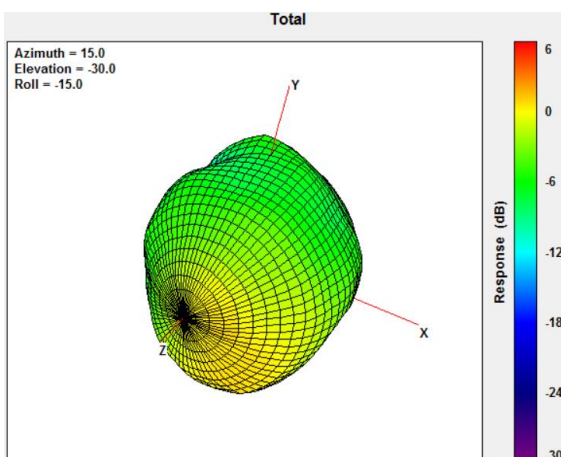

960MHz

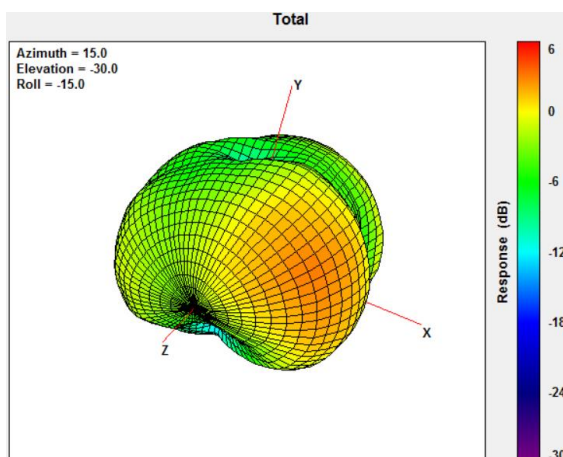

1710MHz

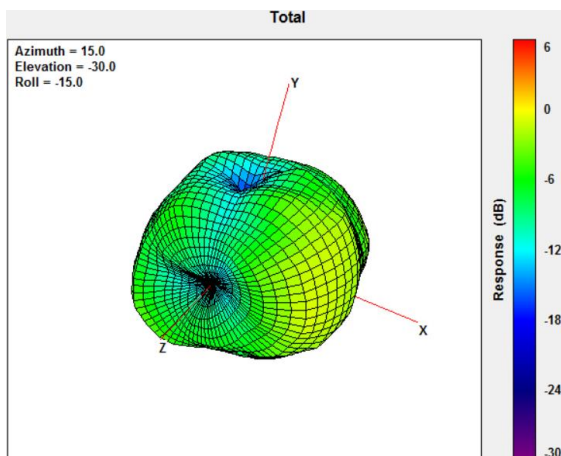

2170MHz

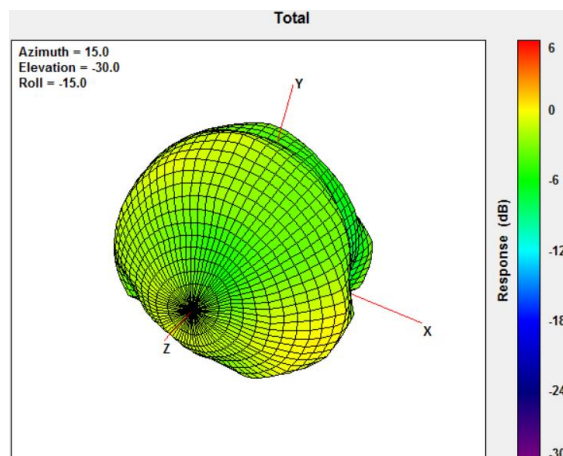

2600MHz



TAOGLAS

5. Mechanical Drawing

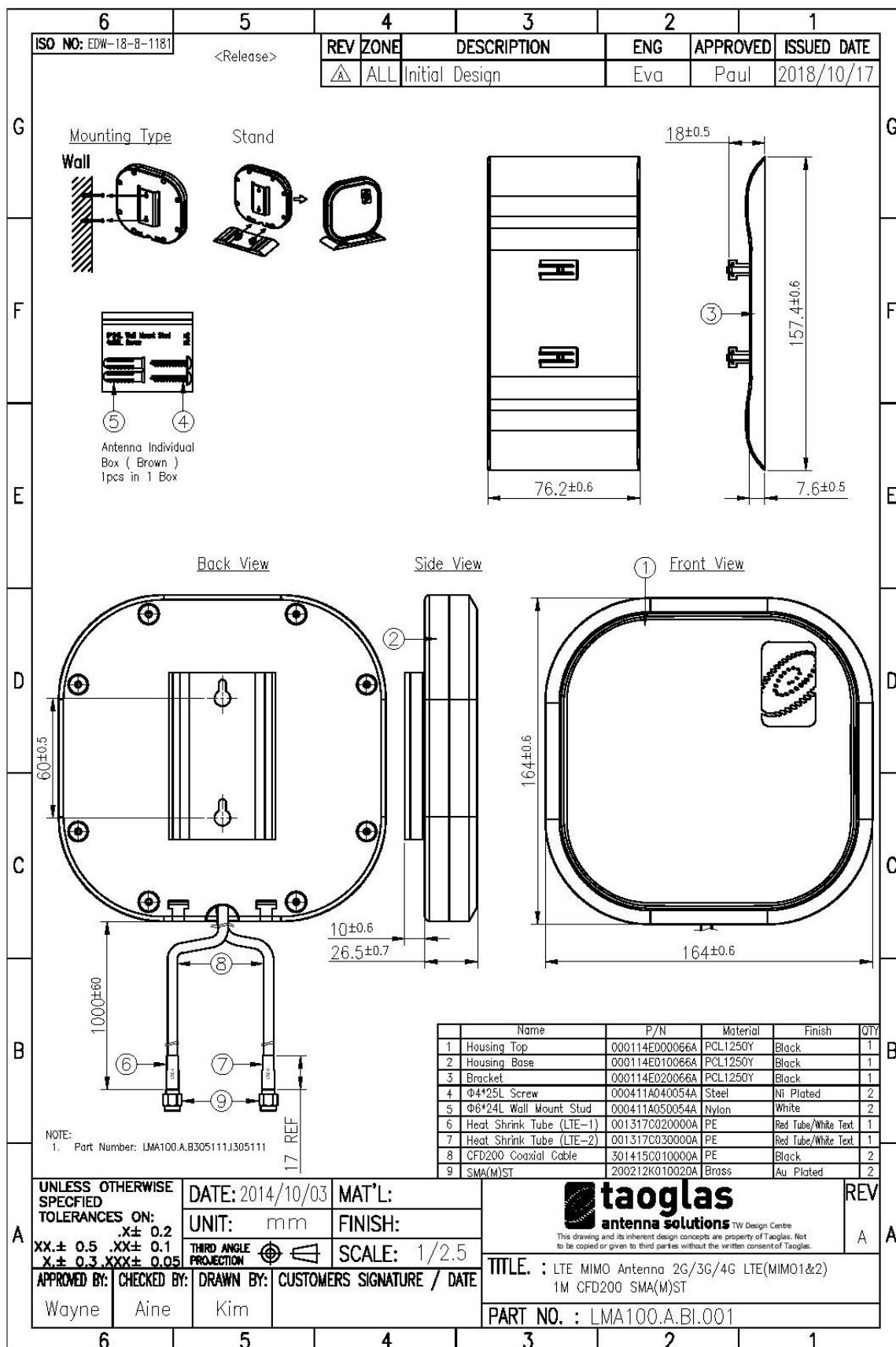

6. Packaging

LMA100.A.BI.001

Packaging Specifications

1pc LMA100.A.BI.001 per small box
 Box Dimensions - 235*170*110mm
 Weight - 650g

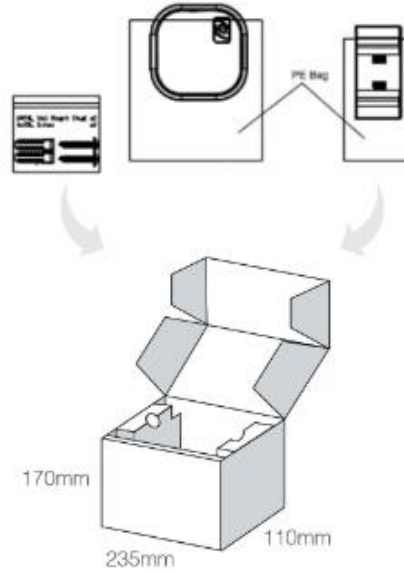

5 small boxes in one carton
 Carton Dimensions - 360*290*260mm
 Weight - 3.8Kg

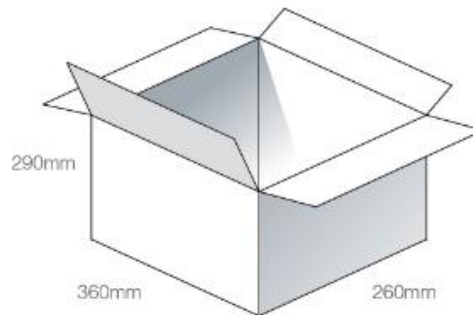

Pallet Dimensions 1100*1100*1290mm
 48 Cartons per Pallet
 12 Cartons per layer
 4 Layers

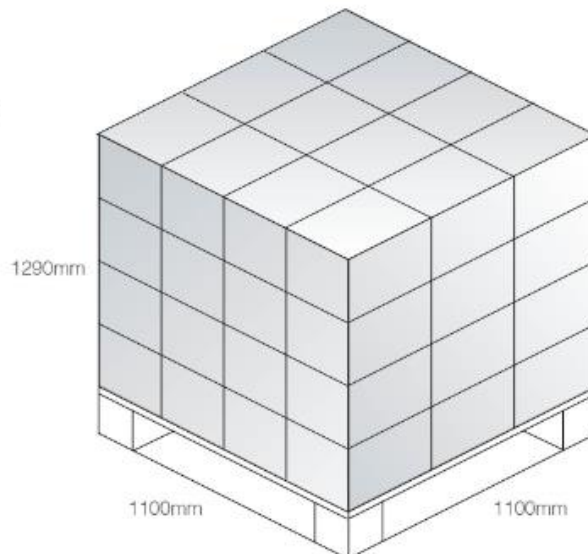

7. Installation Instructions

7.1. Package Contents

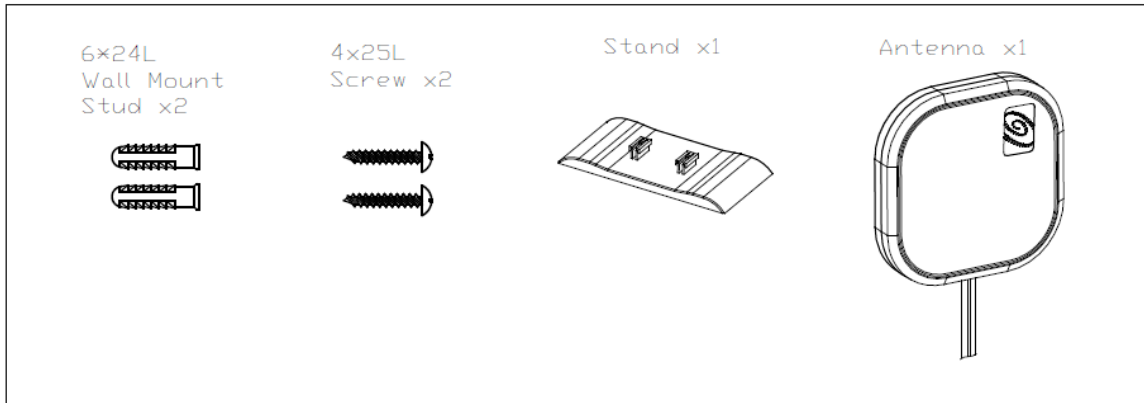

7.2. Desktop Stand Installation

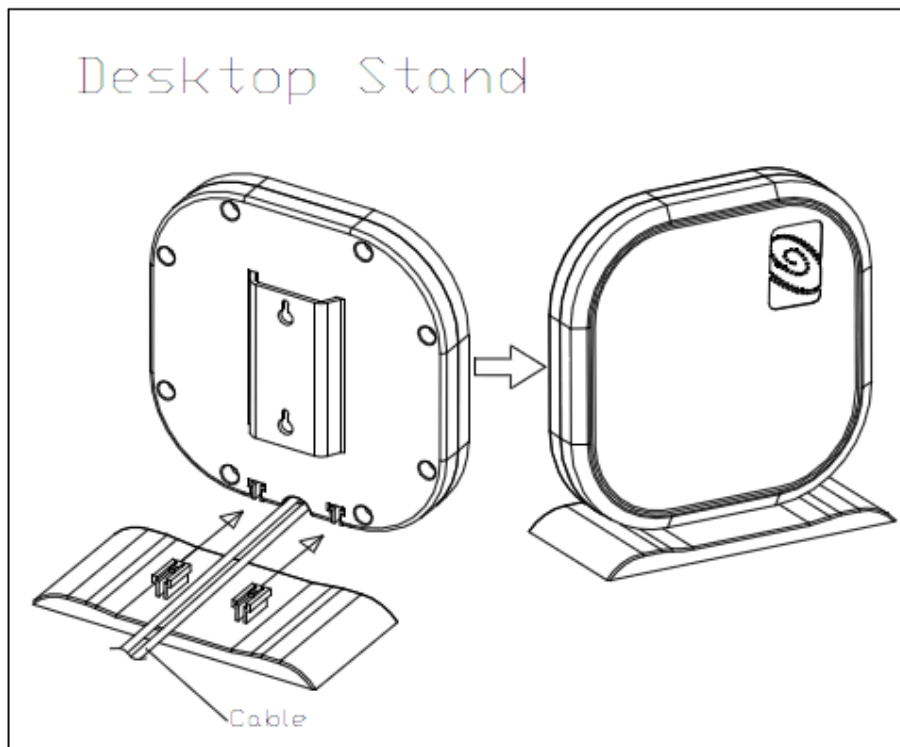

7.3. Wall Mount Installation

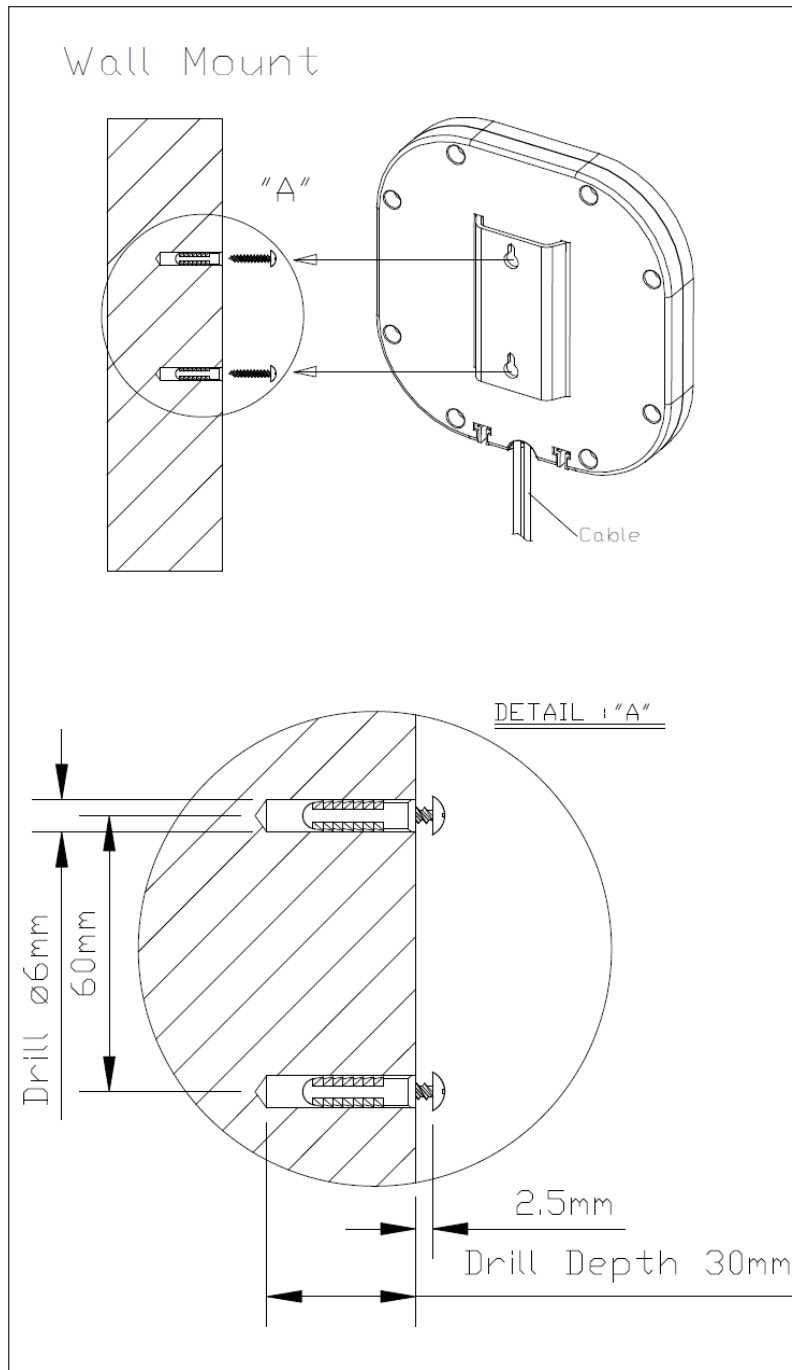

8. Application Note

The LMA.100 antenna performance with different cable lengths is shown below.

8.1. Isolation (Insertion Loss)

8.1.1. S21

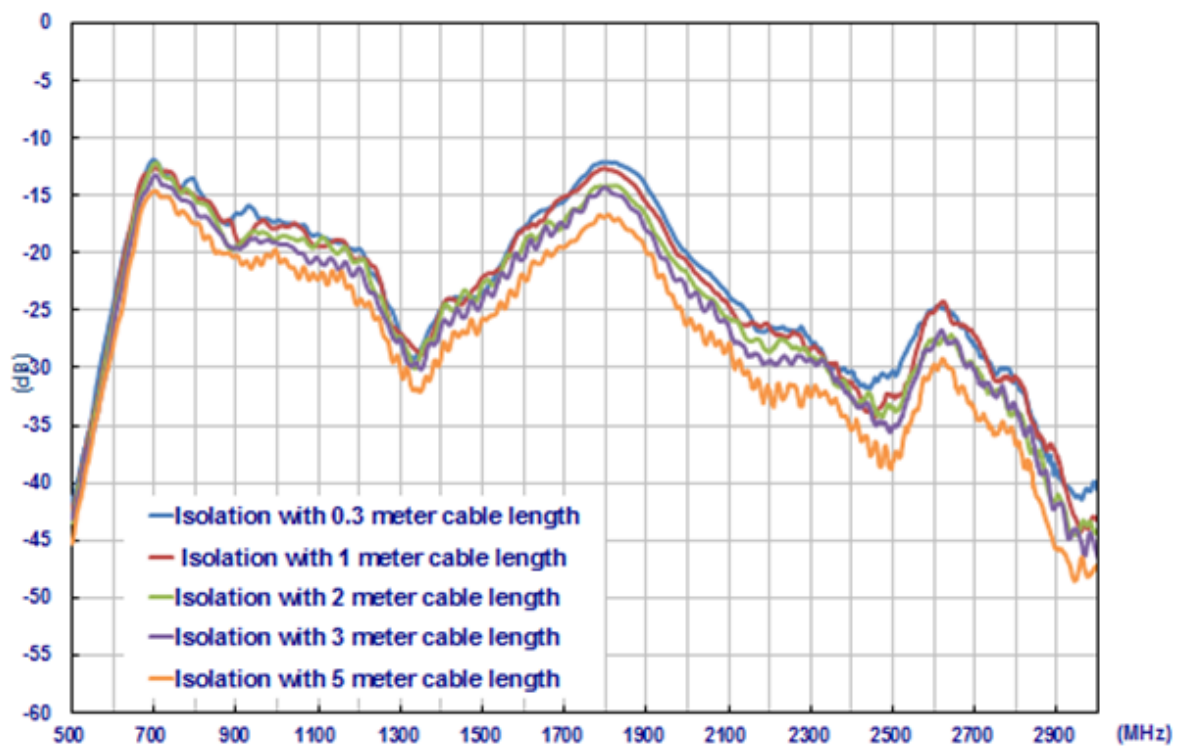

8.2. Return Loss

8.2.1. MIMO1

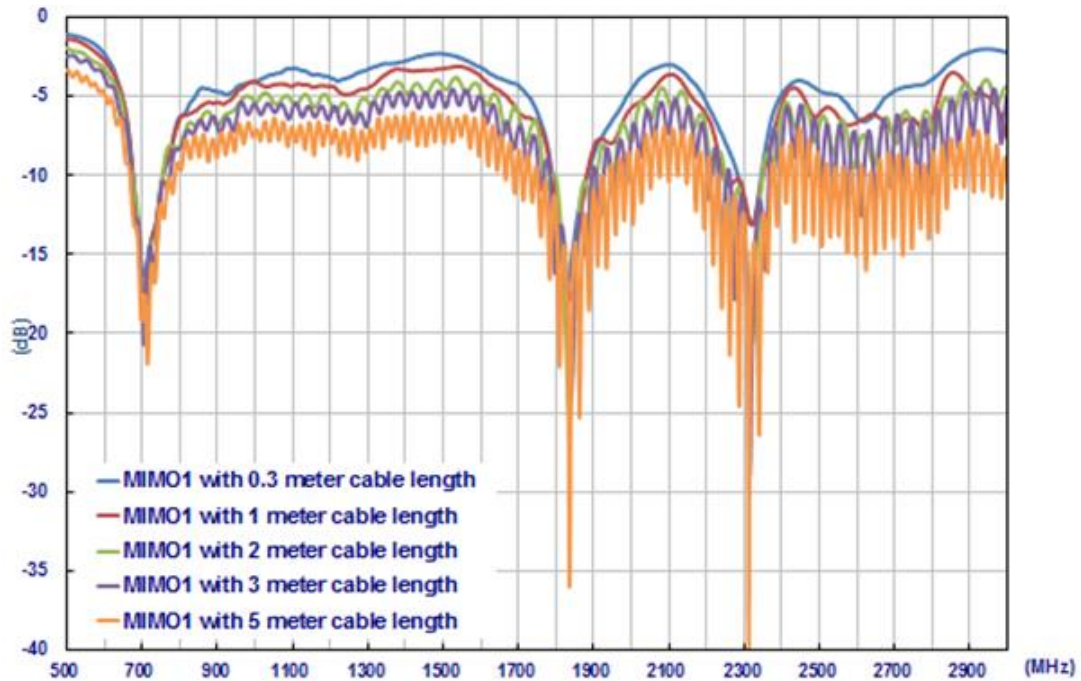

8.2.2. MIMO2

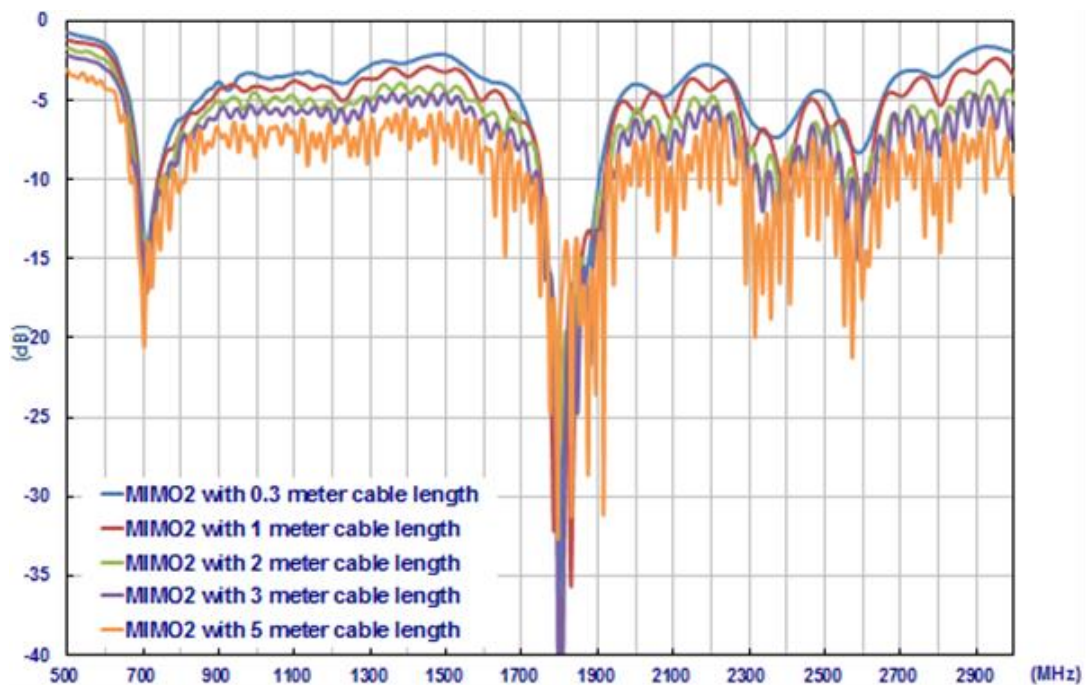

8.3. Efficiency

8.3.1. MIMO1

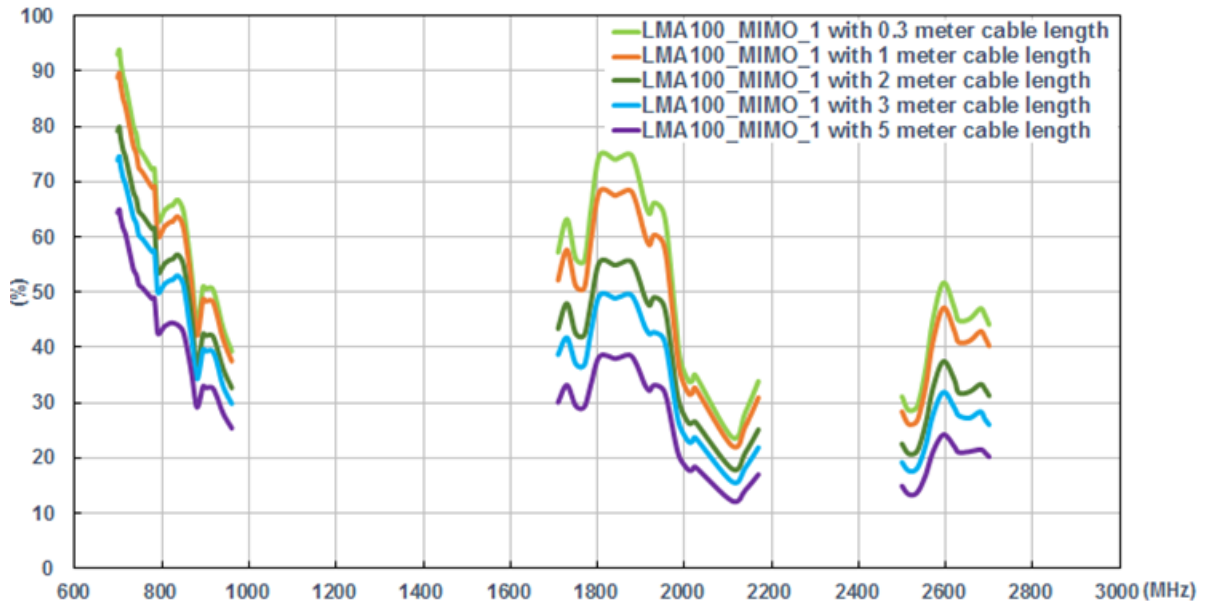

8.3.2. MIMO2

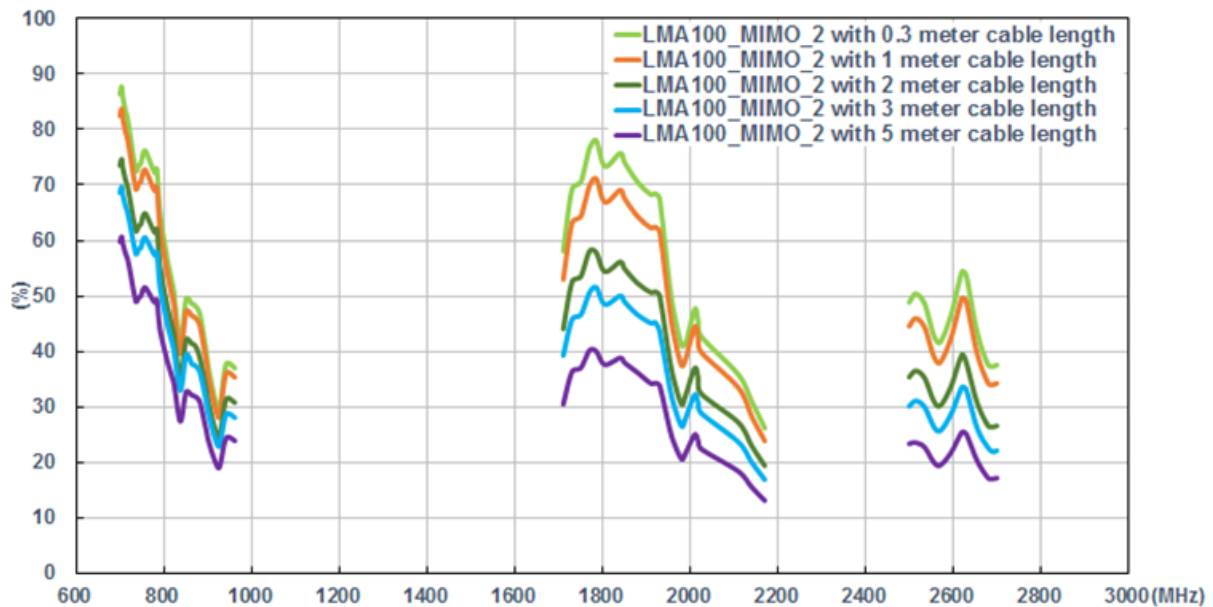

8.4. Average Gain

8.4.1. MIMO1

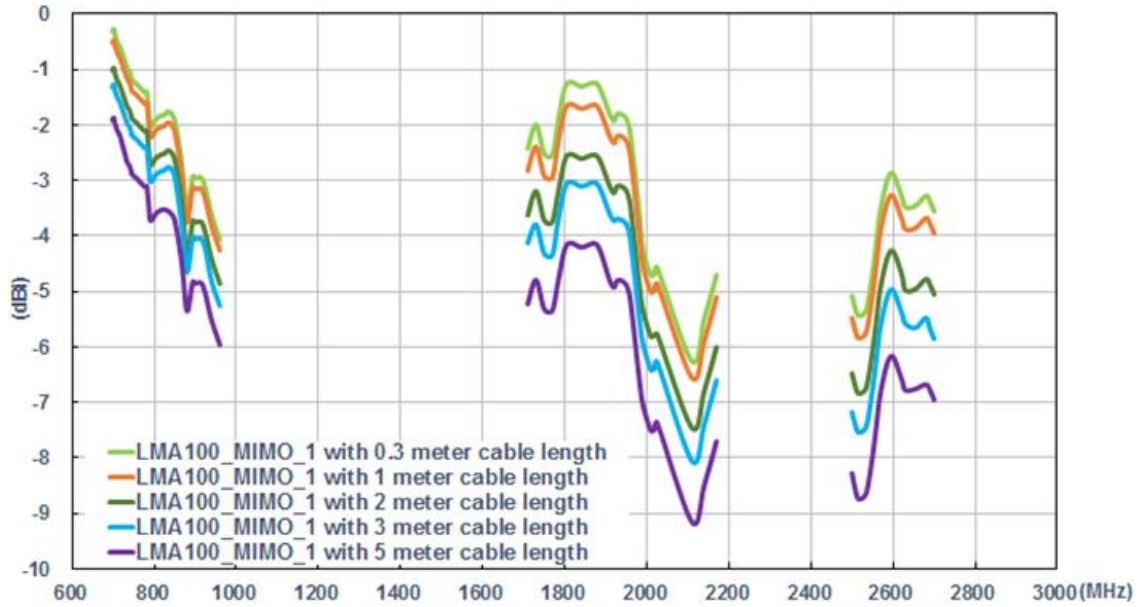

8.4.2. MIMO2

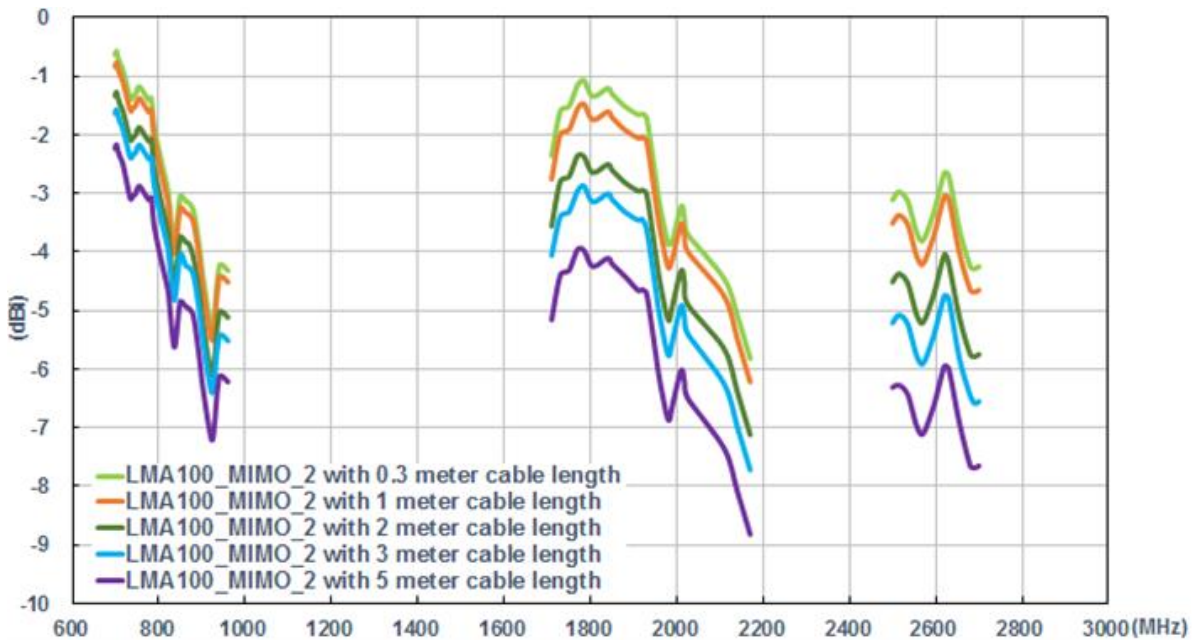

8.5. Peak Gain

8.5.1. MIMO1

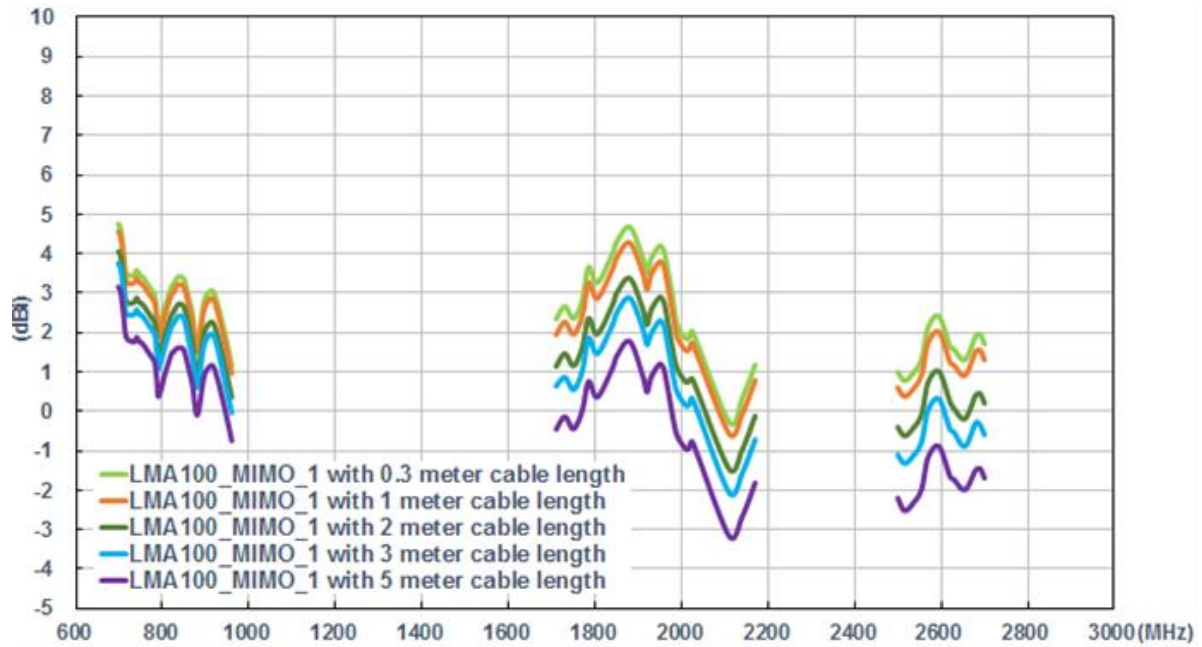

8.5.2. MIMO2

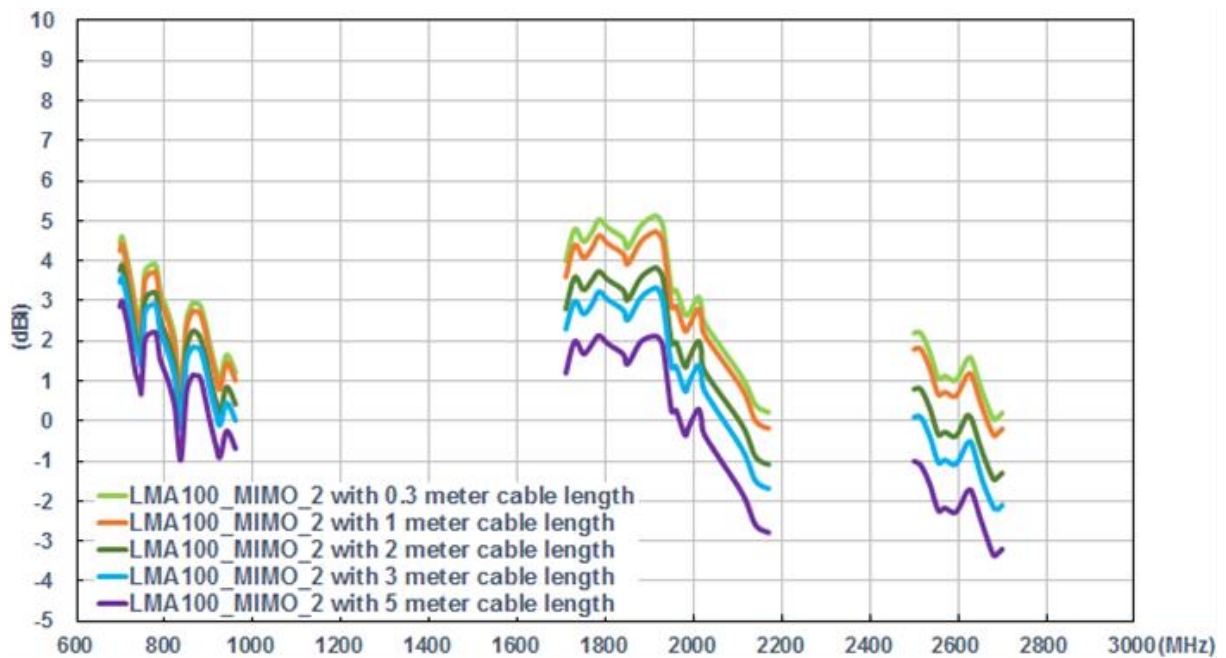

Taoglas makes no warranties based on the accuracy or completeness of the contents of this document and reserves the right to make changes to specifications and product descriptions at any time without notice. Taoglas reserves all rights to this document and the information contained herein.

Reproduction, use or disclosure to third parties without express permission is strictly prohibited.

Copyright © Taoglas Ltd.