

Specification

Part No.	:	GW.15.2113
Product Name	:	2.4GHz 3dBi Terminal Mount Dipole Antenna
Description	:	SMA Male Straight Connector Peak Gain 3dBi High Efficiency up to 85% Works well with or without ground plane Hinged Design for Straight or 90° Degree Mounting Robust TPU Housing Dimensions: 108.5 x 10mm RoHS & REACH Compliant



1. Introduction

The GW.15 2.4GHz dipole SMA terminal mount antenna is ideal for 2.4GHz wireless applications such as Bluetooth and Wireless LAN. At only 108mm in length, an omnidirectional 3dBi gain across all bands ensures constant reception and transmission. The antenna structure is designed for robust handling and the housing is made with TPU giving superior environmental reliability and a quality finish. The antenna can be rotated 90 degrees on the base hinge for ease of placement.

Many module manufacturers specify peak gain limits for any antennas that are to be connected to that module. Those peak gain limits are based on free-space conditions. In practice, the peak gain of an antenna tested in free-space can degrade by at least 1 or 2dBi when put inside a device. So ideally you should go for a slightly higher peak gain antenna than mentioned on the module specification to compensate for this effect, giving you better performance.

Upon testing of any of our antennas with your device and a selection of appropriate layout, integration technique, or cable, Taoglas can make sure any of our antennas' peak gain will be below the peak gain limits. Taoglas can then issue a specification and/or report for the selected antenna in your device that will clearly show it complying with the peak gain limits, so you can be assured you are meeting regulatory requirements for that module.

For example, a module manufacturer may state that the antenna must have less than 2dBi peak gain, but you don't need to select an embedded antenna that has a peak gain of less than 2dBi in free-space. This will give you a less optimized solution. It is better to go for a slightly higher free-space peak gain of 3dBi or more if available. Once that antenna gets integrated into your device, performance will degrade below this 2dBi peak gain due to the effects of GND plane, surrounding components, and device housing.

If you want to be absolutely sure, contact Taoglas and we will test. Choosing a Taoglas antenna with a higher peak gain than what is specified by the module manufacturer and enlisting our help will ensure you are getting the best performance possible without exceeding the peak gain limits. It is better not to select an embedded antenna with very low free-space peak gain (<2dBi) directly, as this antenna would have worse performance in your device, and lead to compromised performance compared to using a Taoglas antenna.

2. Specification

ELECTRICAL	
Frequency	2.4~2.5 GHz
Peak Gain*	3 dBi
VSWR	≤ 1.8
Return Loss**	≥12dB
Polarization	Vertical
Impedance	50 Ω
Radiation Pattern	Omni-directional
Power Handling	10W
MECHANICAL	
Antenna Length	108.5 mm (Straight) / 87.5mm (Hinged)
Antenna Weight	9g
Antenna Cover	TPU Black
Connector	SMA (M)
Antenna Base	Nylon
ENVIRONMENTAL	
Operating Temperature	-40°C to +85°C
Storage Temperature	-40°C to +90°C

*Tested on a 500mm x 500mm Ground Plane

**Tested on a 150mm x 90mm Ground Plane

3. Test Setup

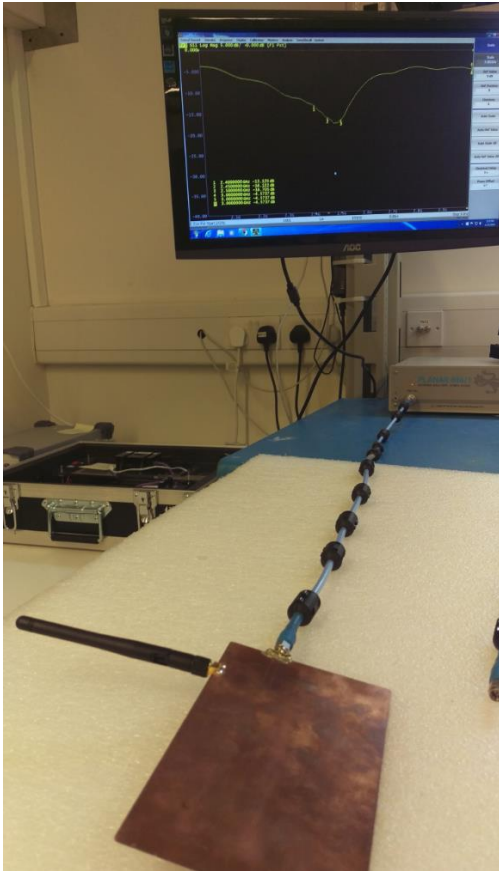

Return Loss Measurement

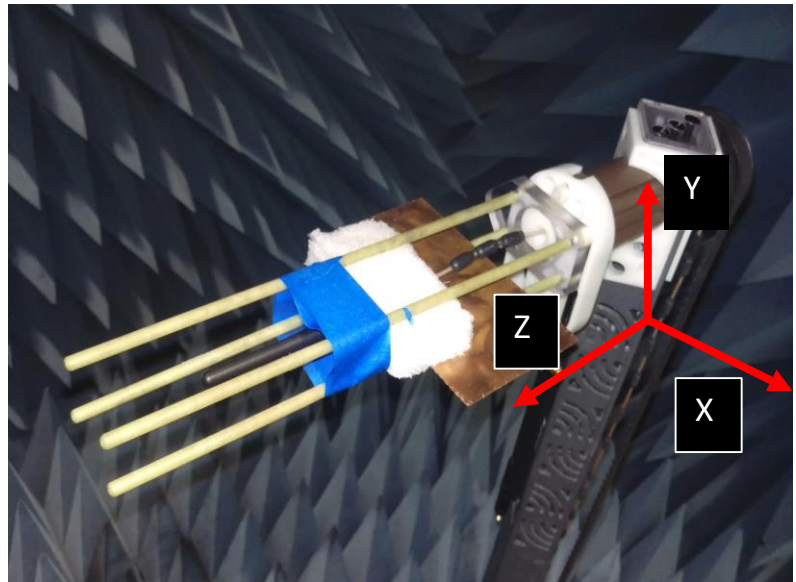

Chamber Setup

4. Antenna Characteristics

4.1 Return Loss

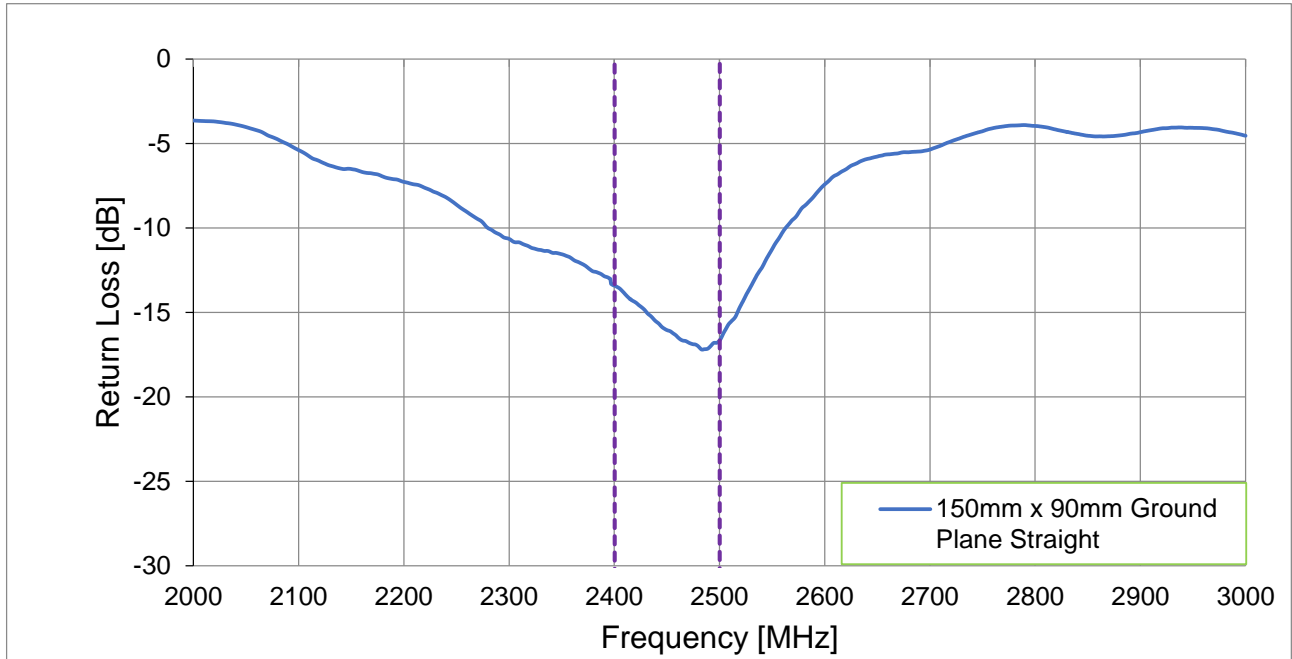

4.2 VSWR

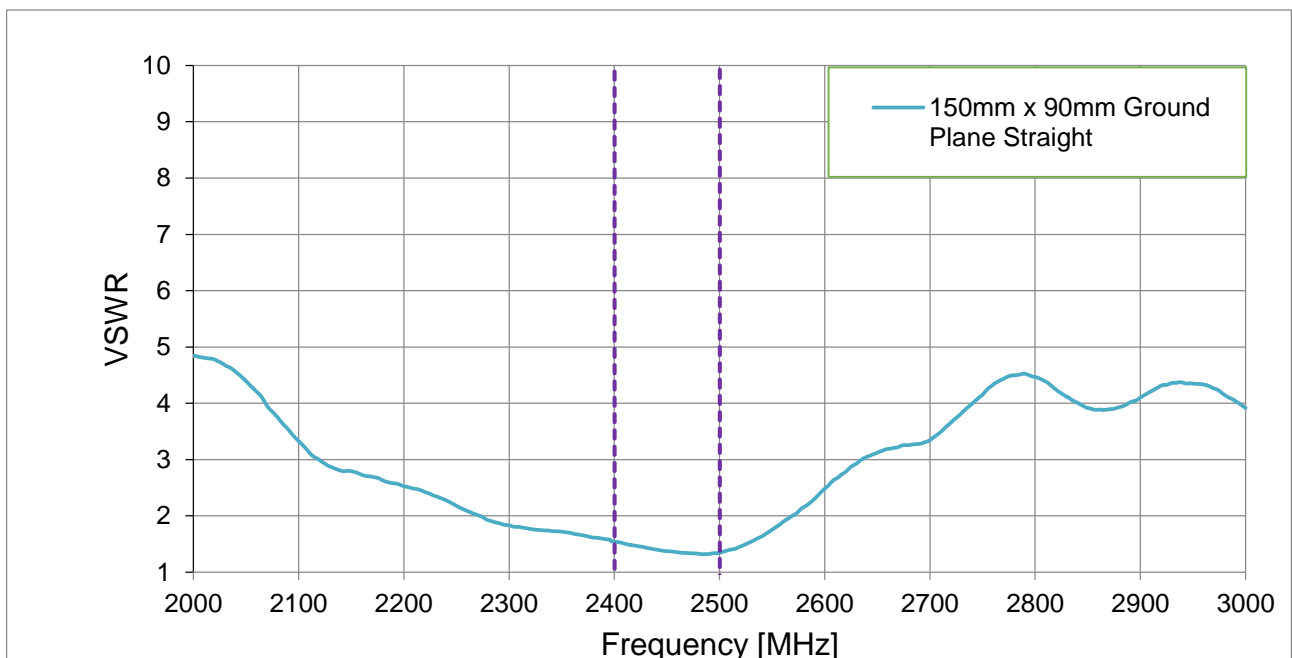

4.3 Efficiency

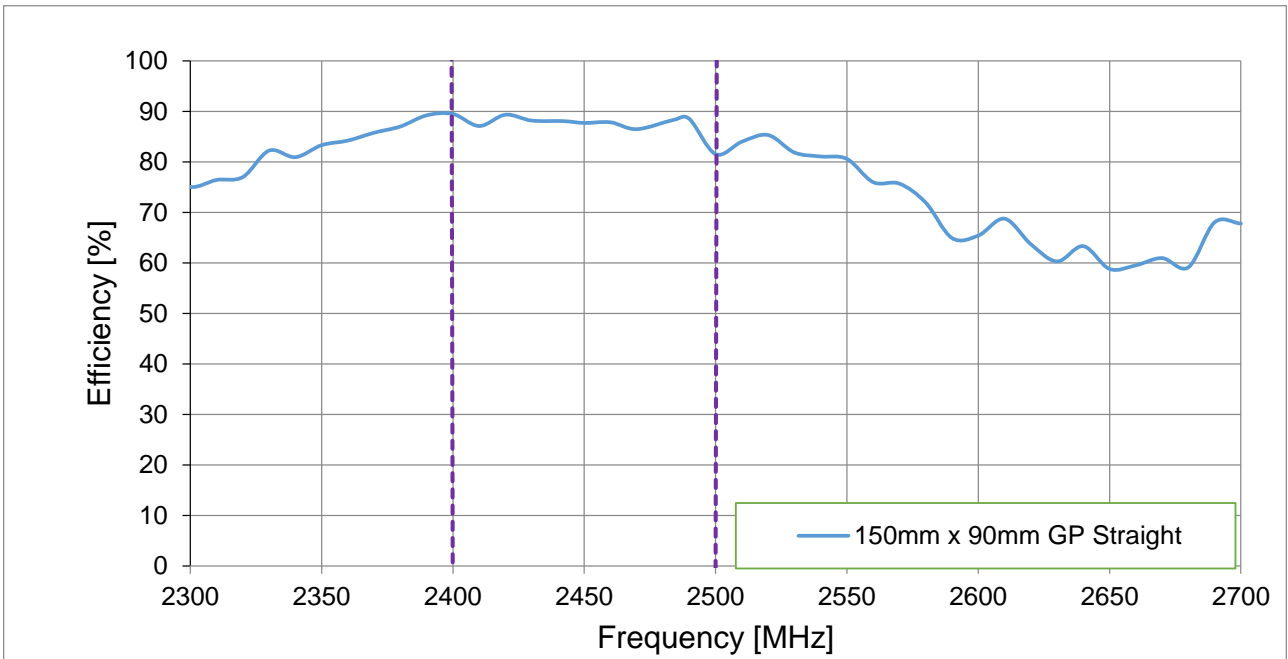

4.4 Peak Gain

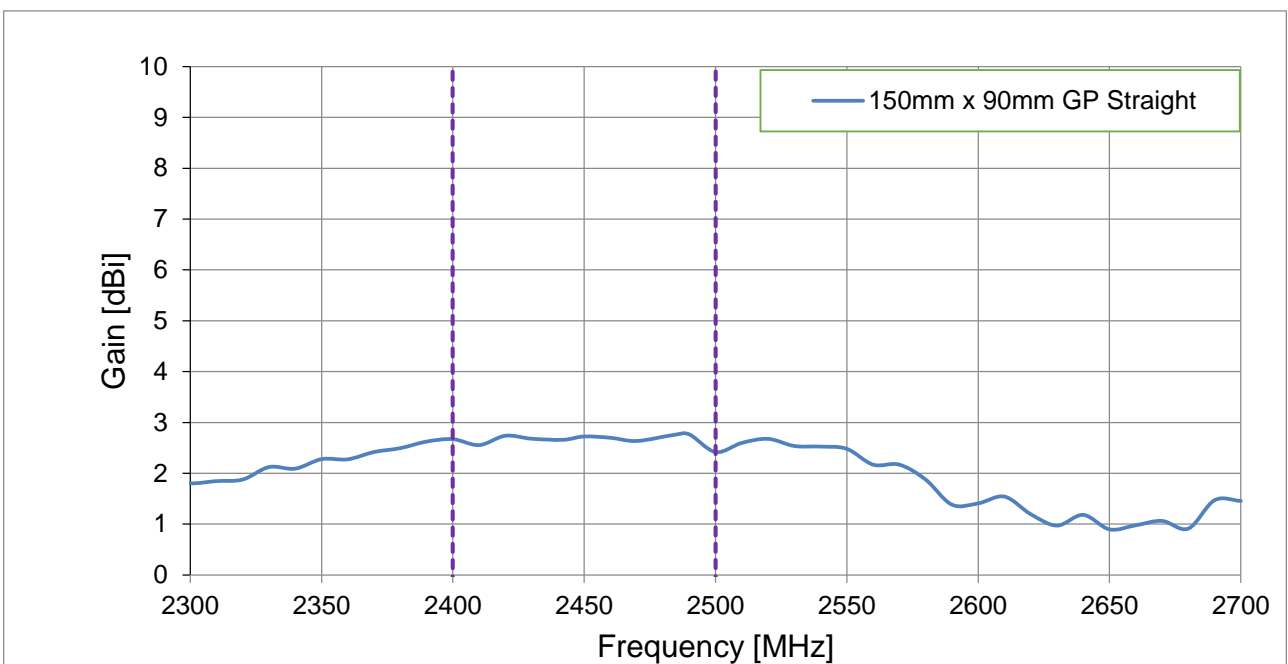

4.5 Average Gain

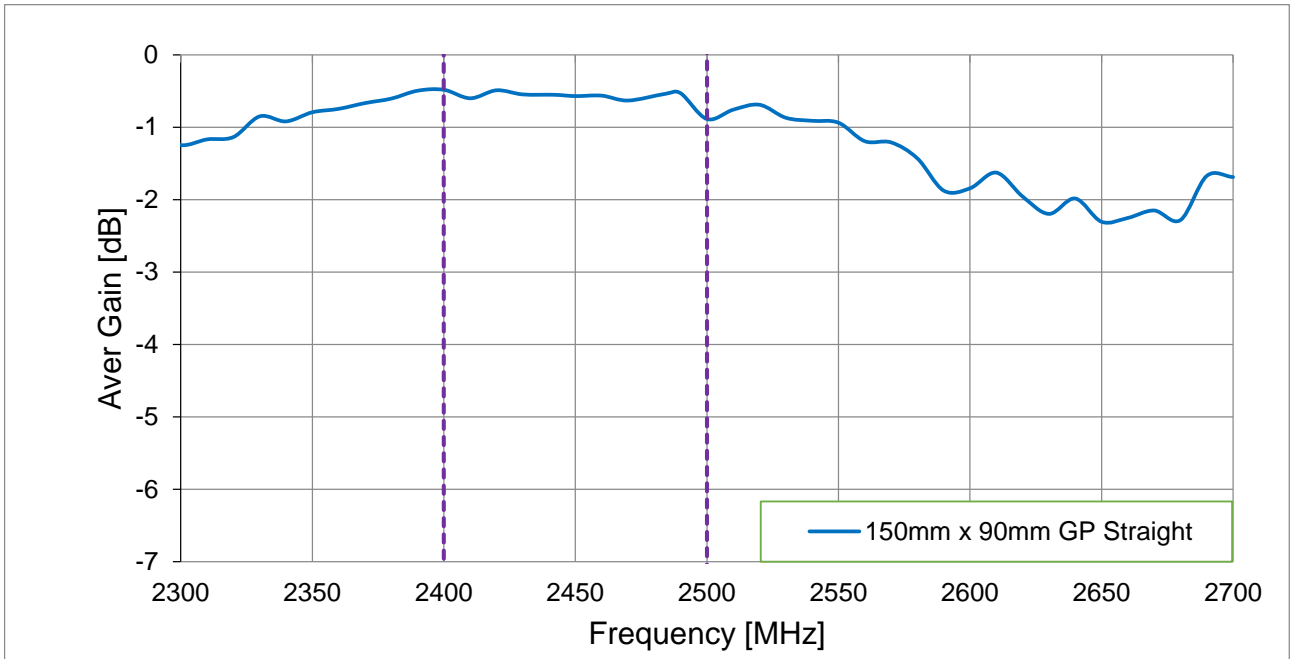

5. Radiation Patterns

5.1 Straight Position XY Plane

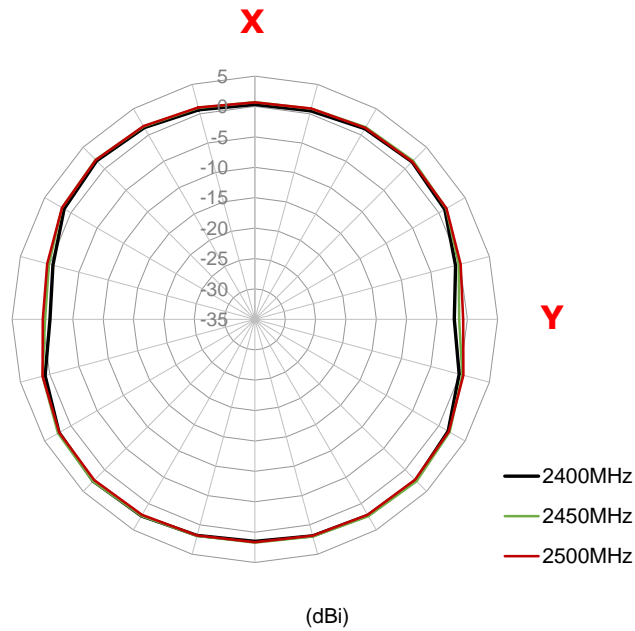

5.2 Straight Position ZX Plane

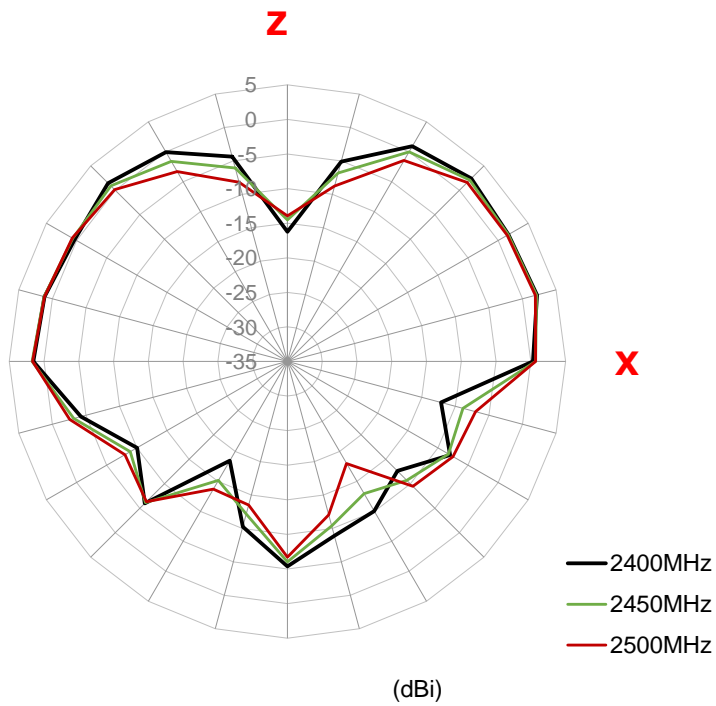

5.3 Straight Position ZY Plane

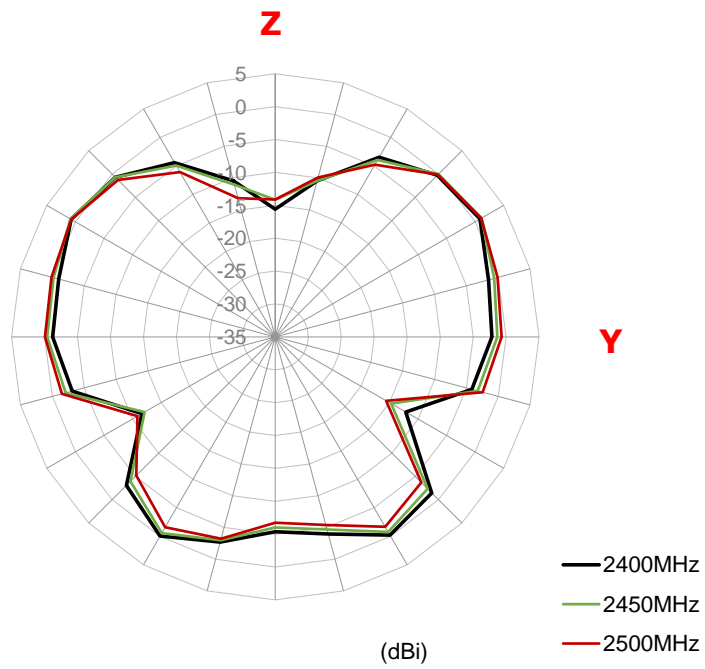

6. Ground Plane Effect

Six ground setups are used to see the effect of positioning the GW.15 close to a ground plane.

1. Extra Small Ground (30mm x 30mm) – common size of Bluetooth devices
2. Small Ground (15 x 9cm) – common size of IoT devices. GW.15 is mounted at the longer edge for testing.
3. Ground Edge (30cm x 30cm) – simulate the effect of mounting antenna on a gateway/router.
4. Ground Centre (30cm x 30cm) – simulate the effect of mounting antenna in the centre of a big ground plane.
5. Large Ground Edge (50cm x 50cm) - simulate the effect of mounting antenna on a large gateway/router.
6. Large Ground Center (50cm x 50cm) - simulate the effect of mounting antenna in the centre of a large ground plane e.g. vehicle body.



Free Space

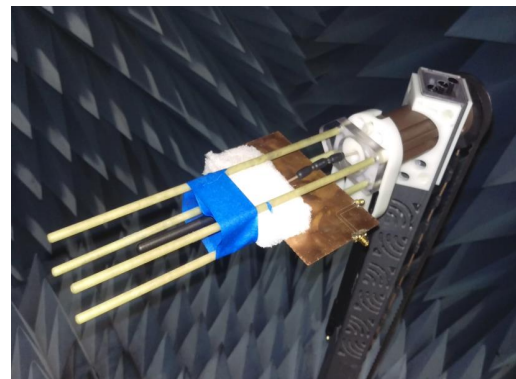

15cm x 9cm Ground Plane Edge

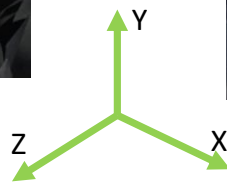

30mm x 30mm Ground Plane Edge

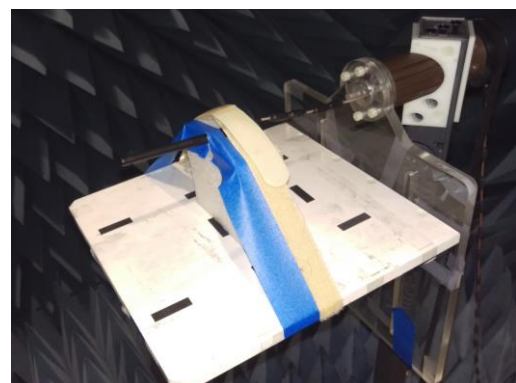

30mm x 30mm Ground Plane Center

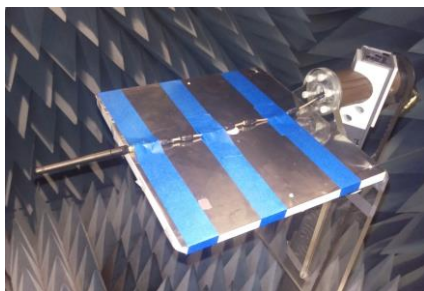

30cm x 30cm Ground Plane Edge

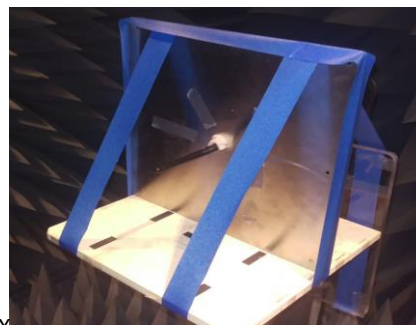

30cm x 30cm Ground Plane Center

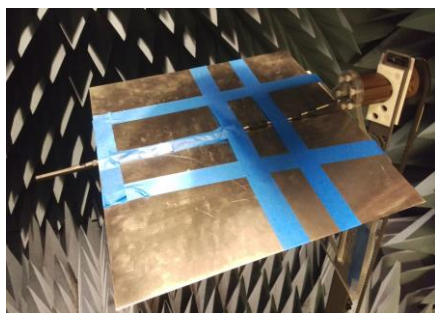

50cm x 50cm Ground Plane Edge



50cm x 50cm Ground Plane Center

6.1 Return Loss (Straight Antenna)

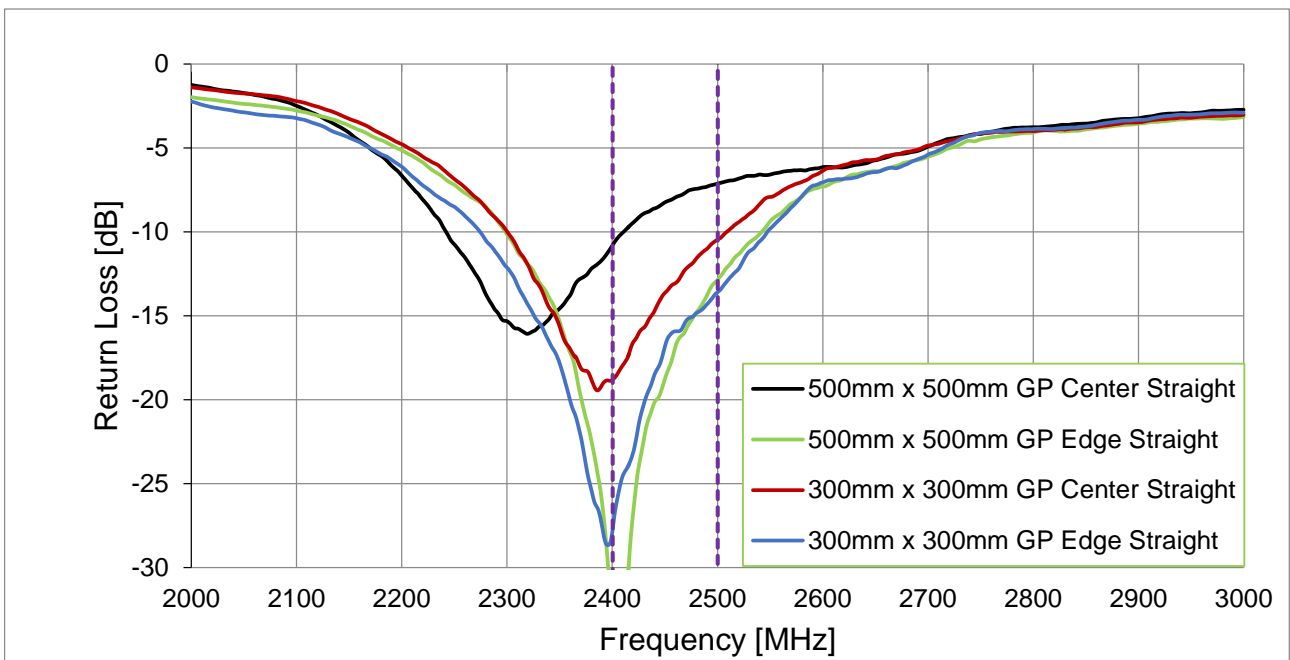
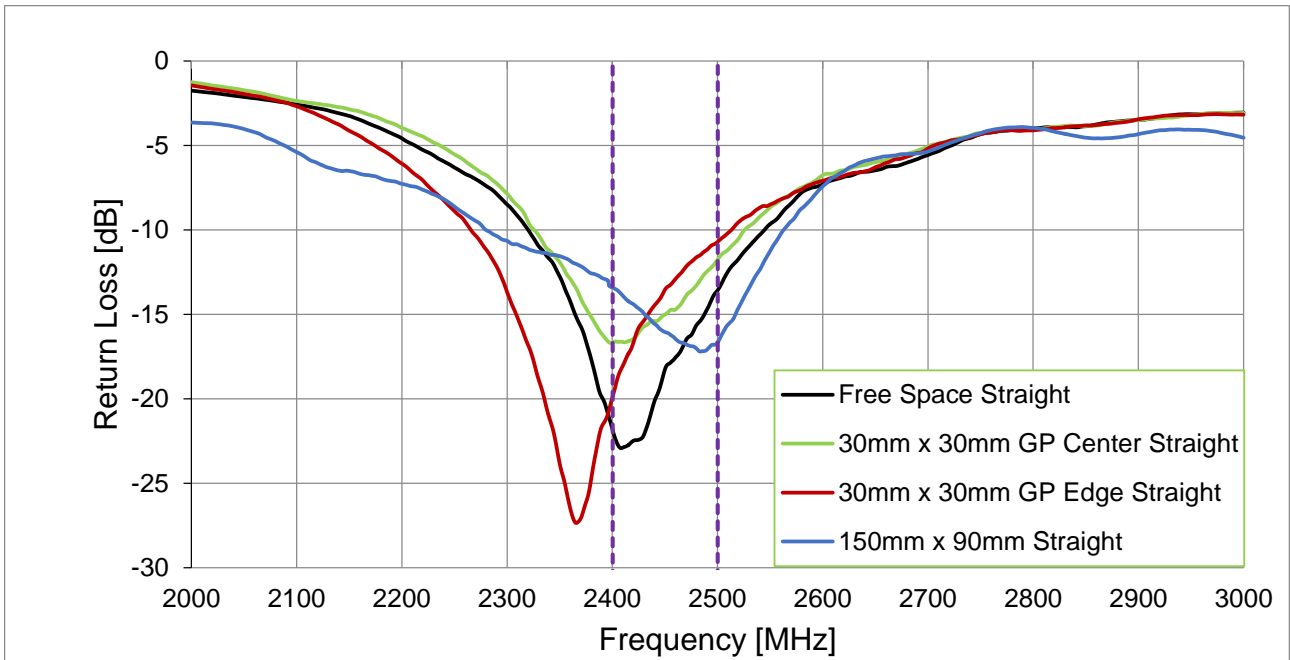

6.2 VSWR (Straight Antenna)

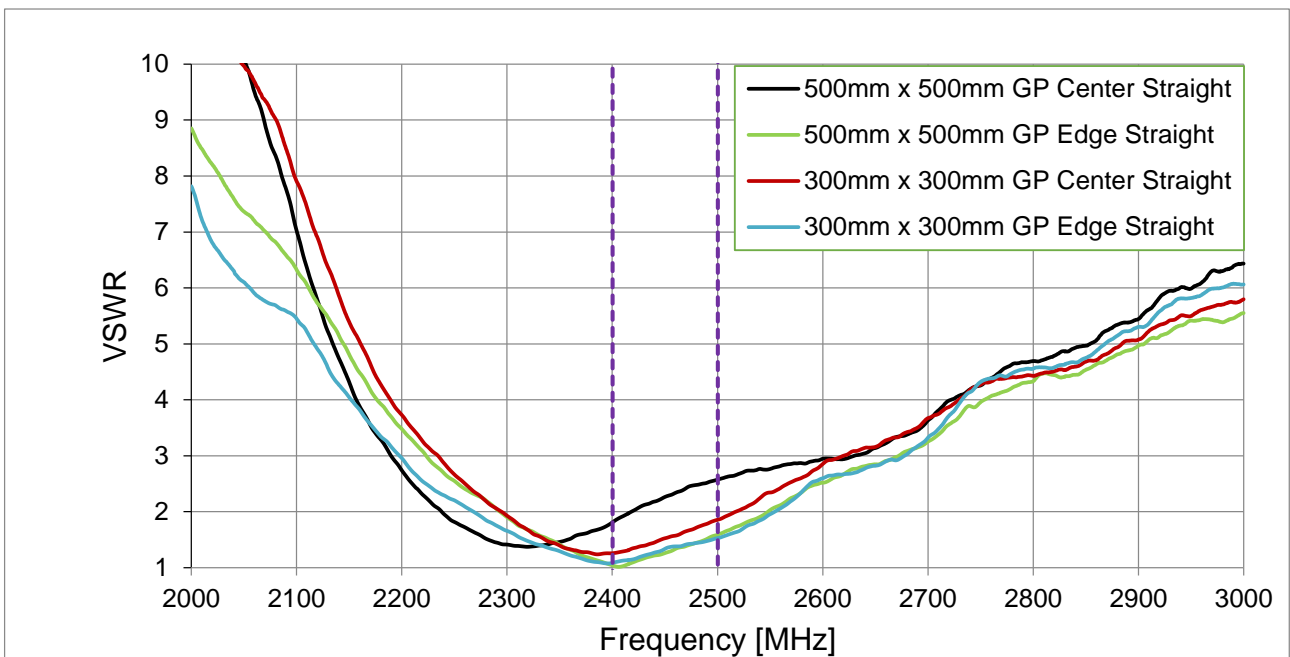
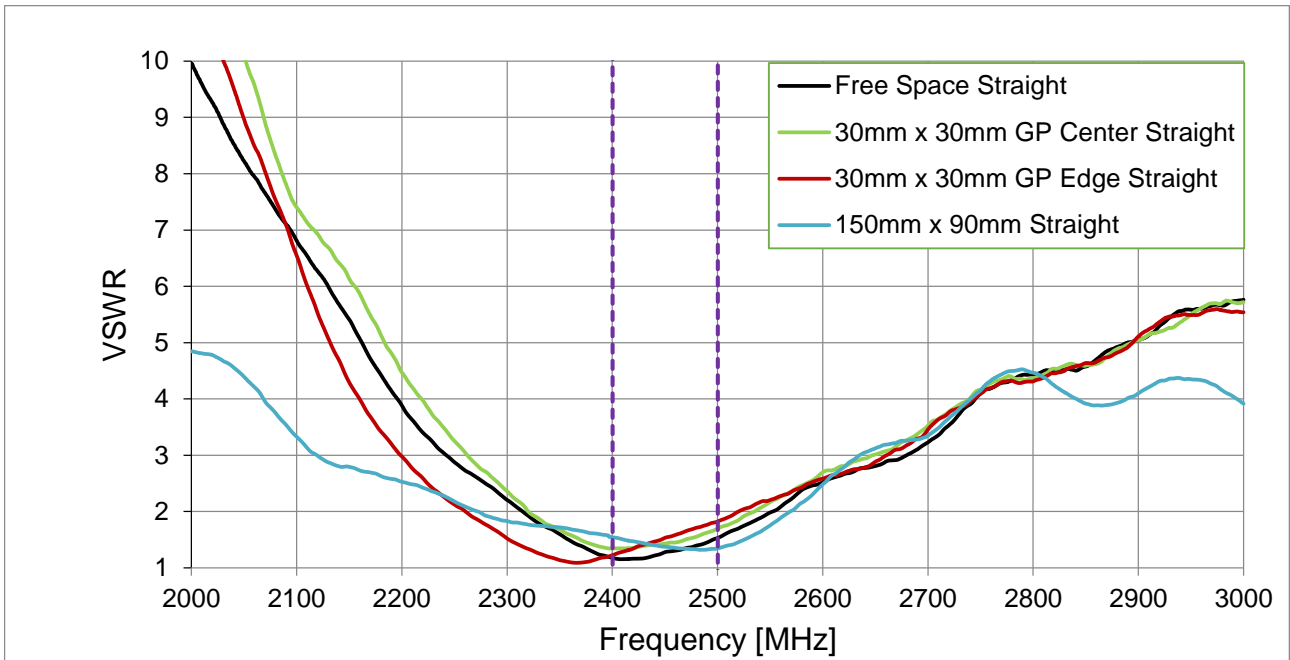



6.3 Efficiency (Straight Antenna)

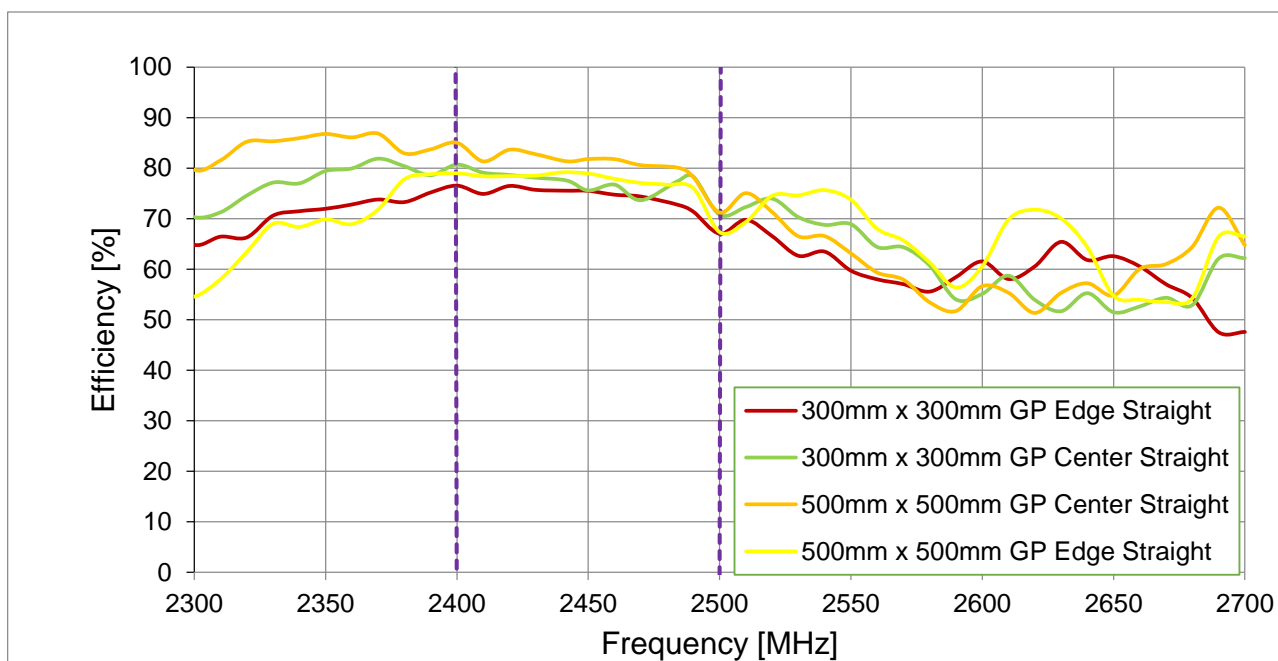
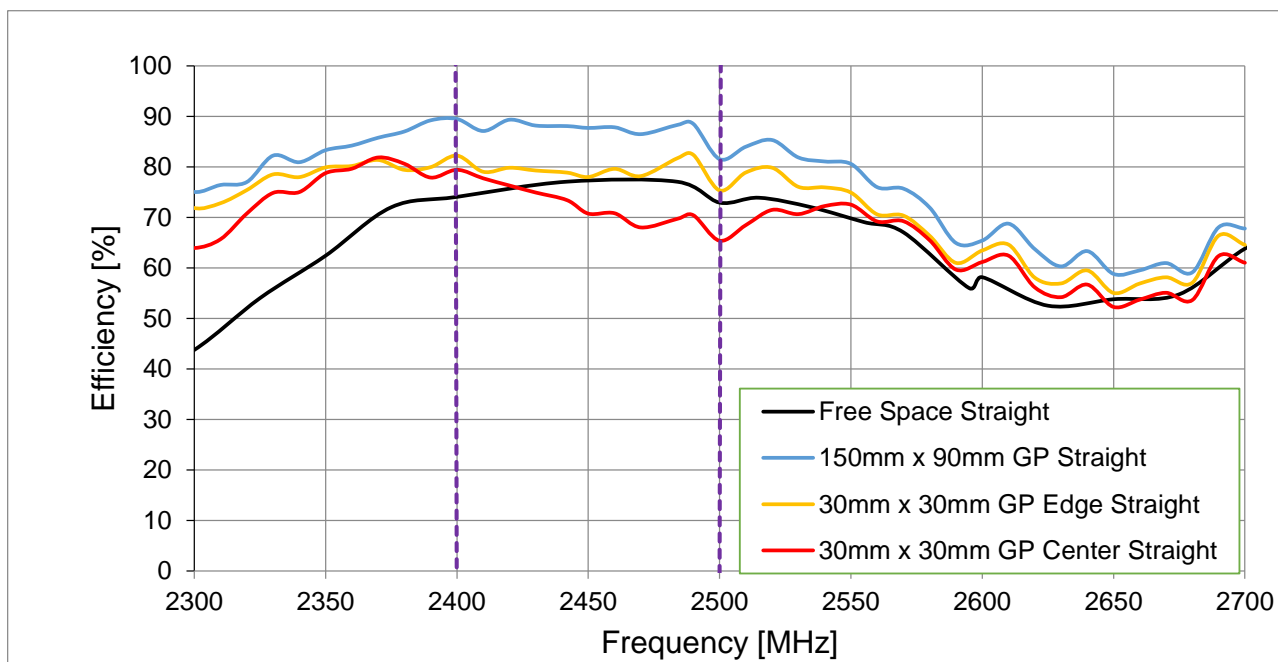

6.4 Peak Gain (Straight Antenna)

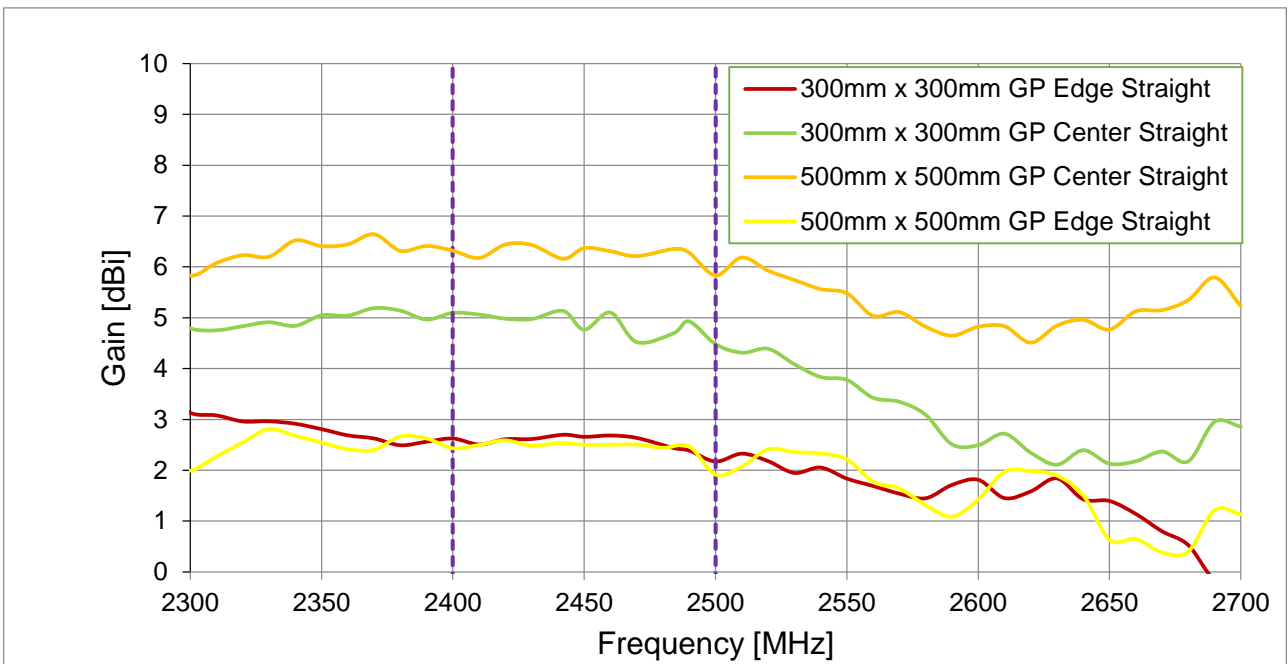
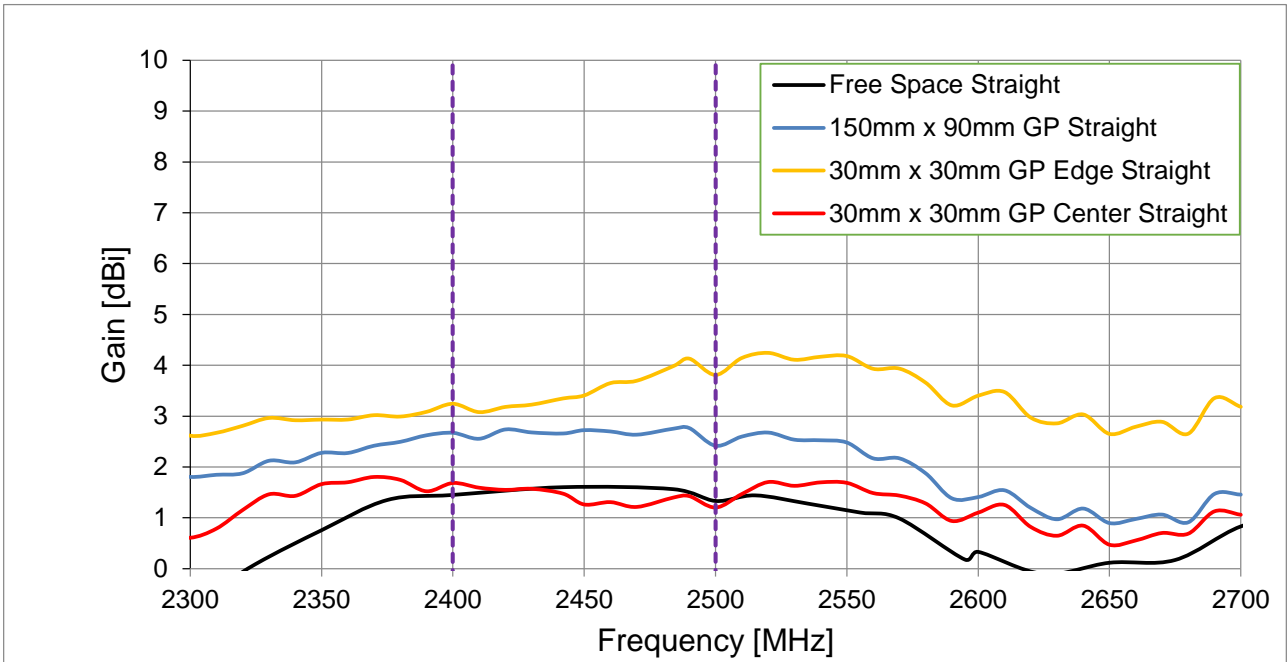



6.5 Average Gain (Straight Antenna)

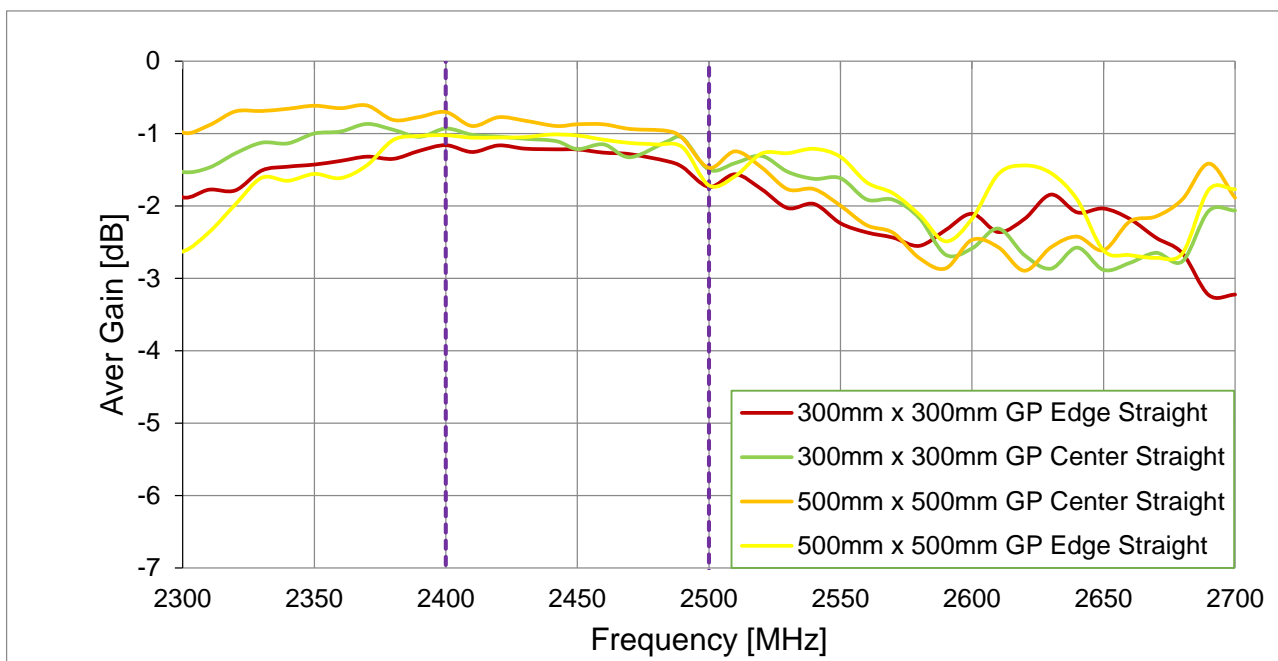
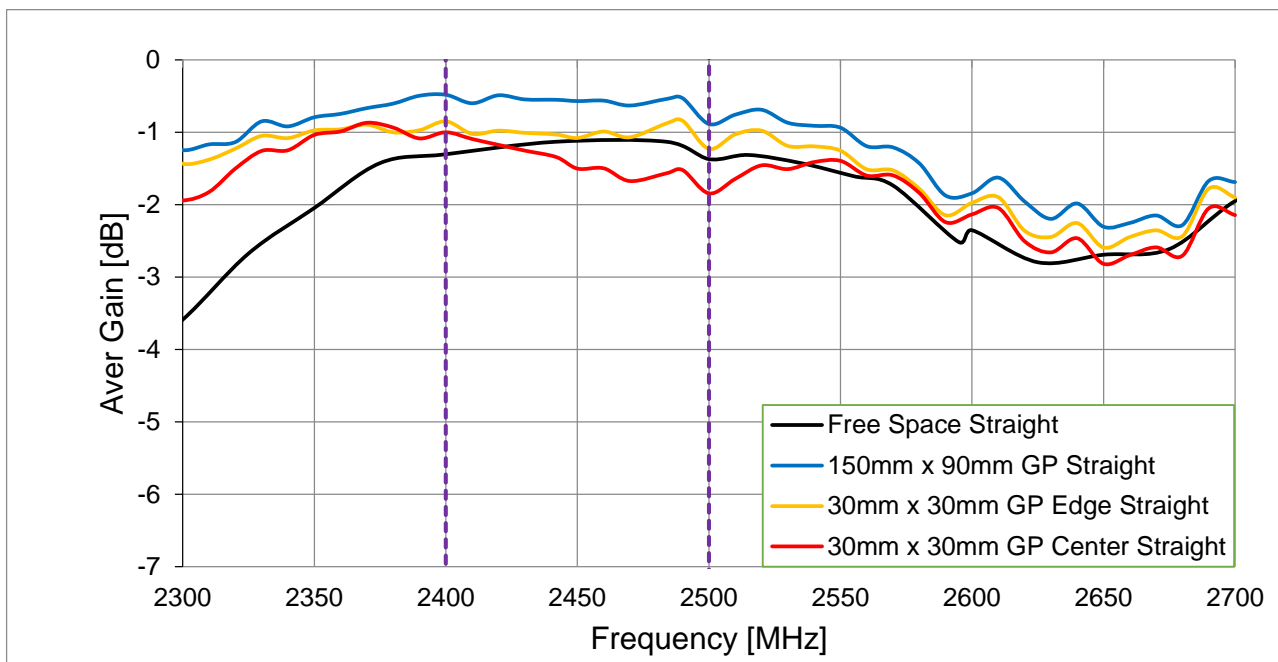



6.6 Return Loss (90° Bend)

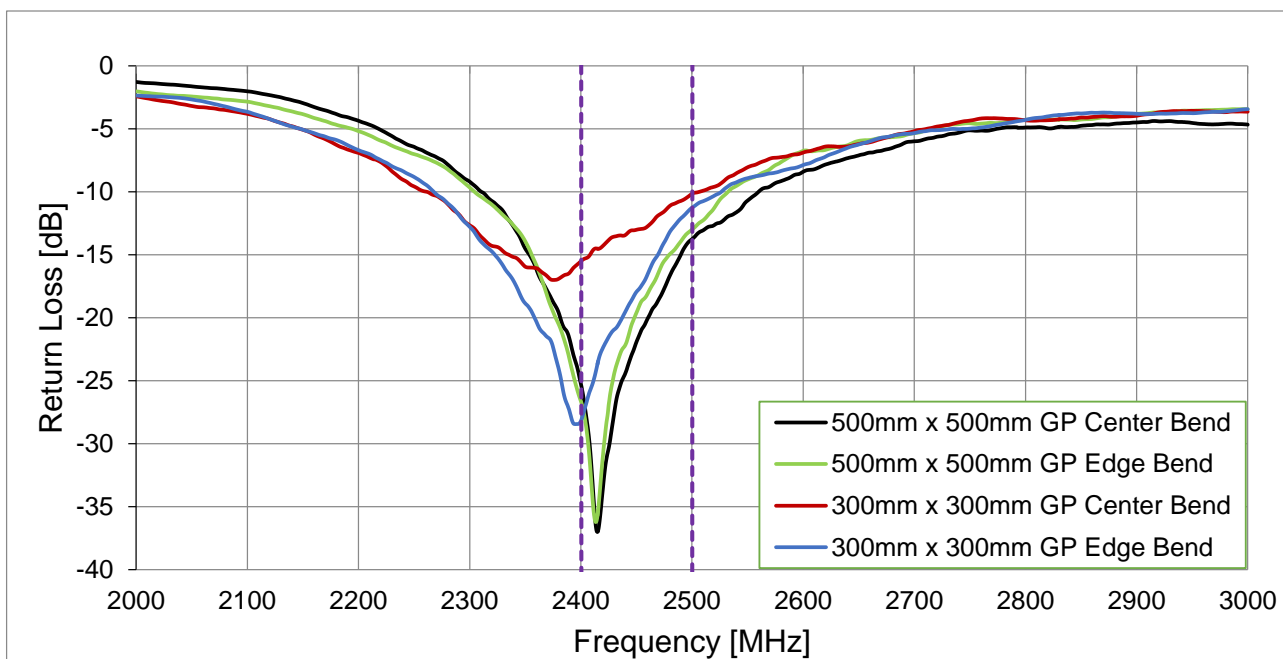
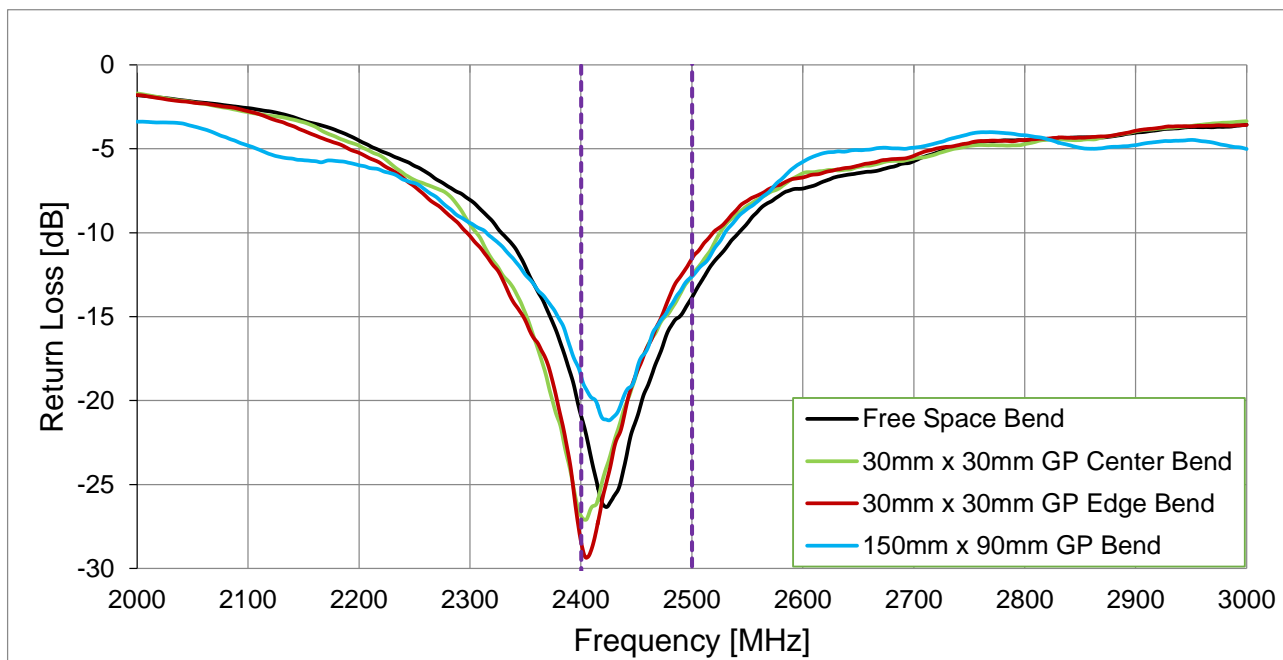

6.7 VSWR (90° Bend)

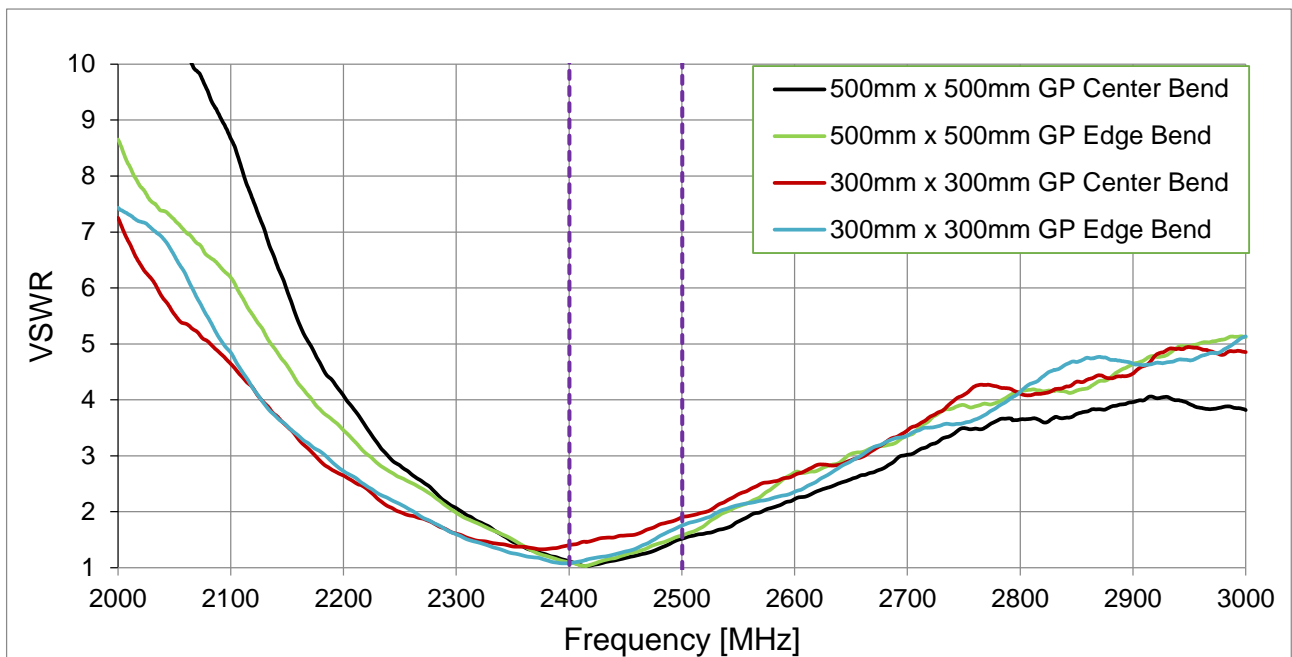
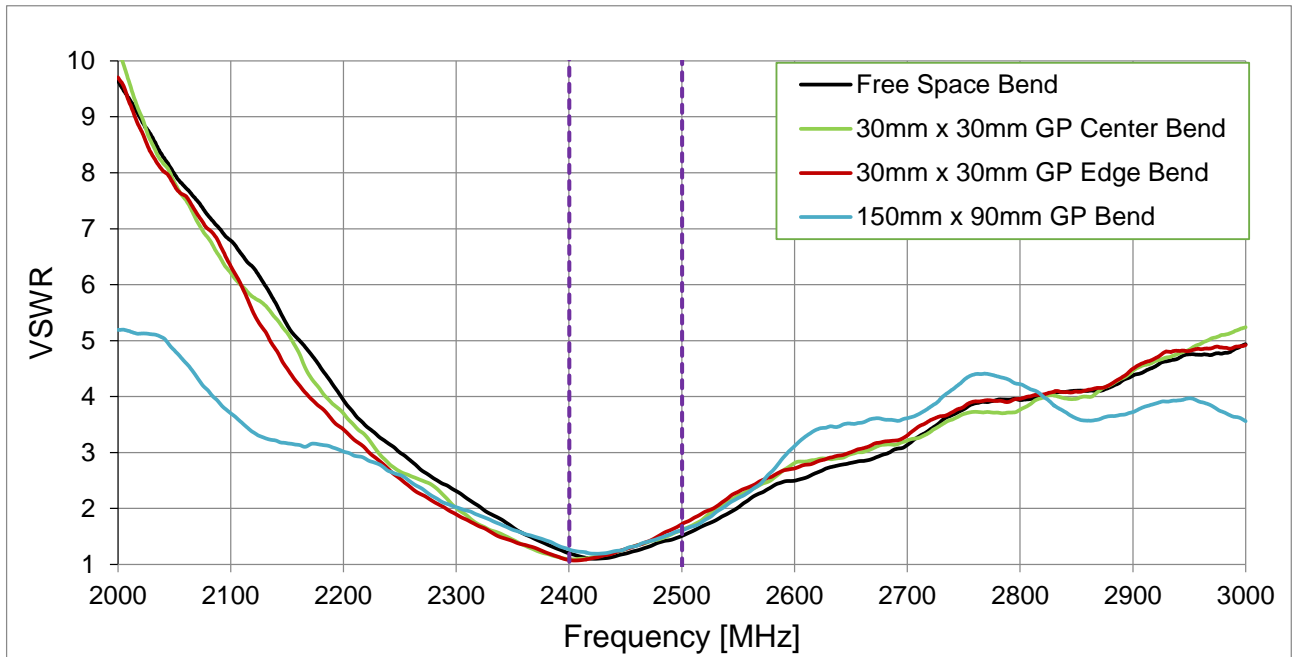

6.8 Efficiency (90° Bend)

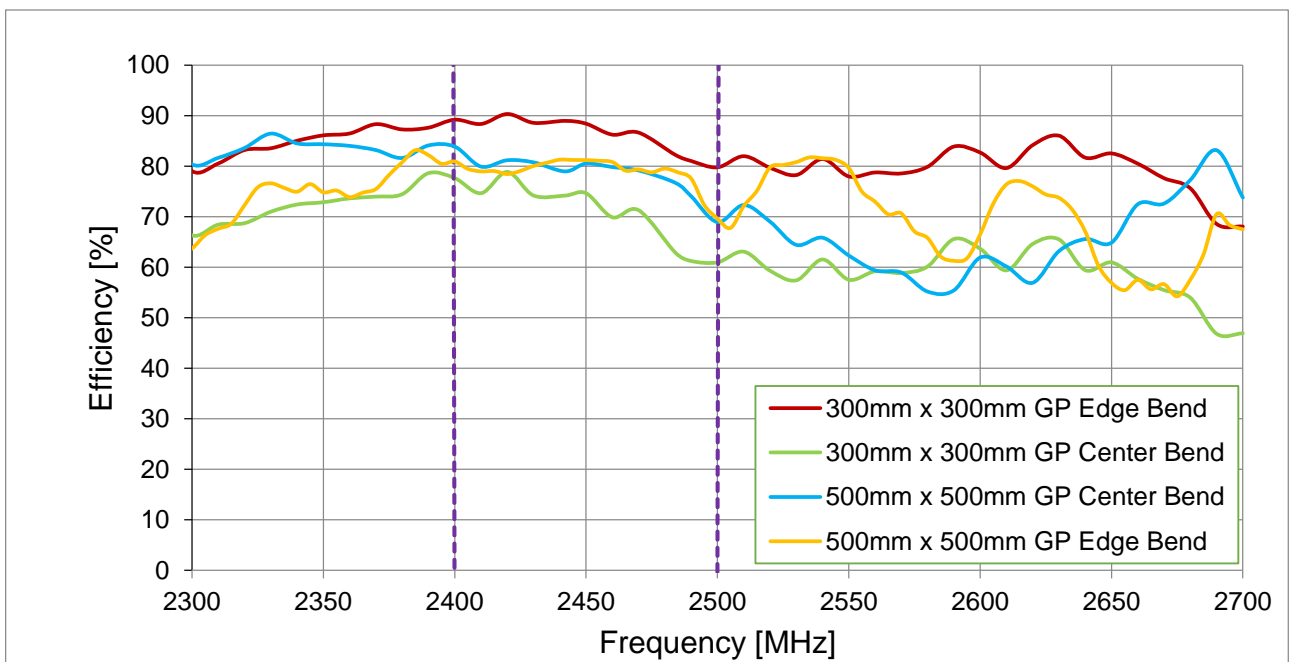
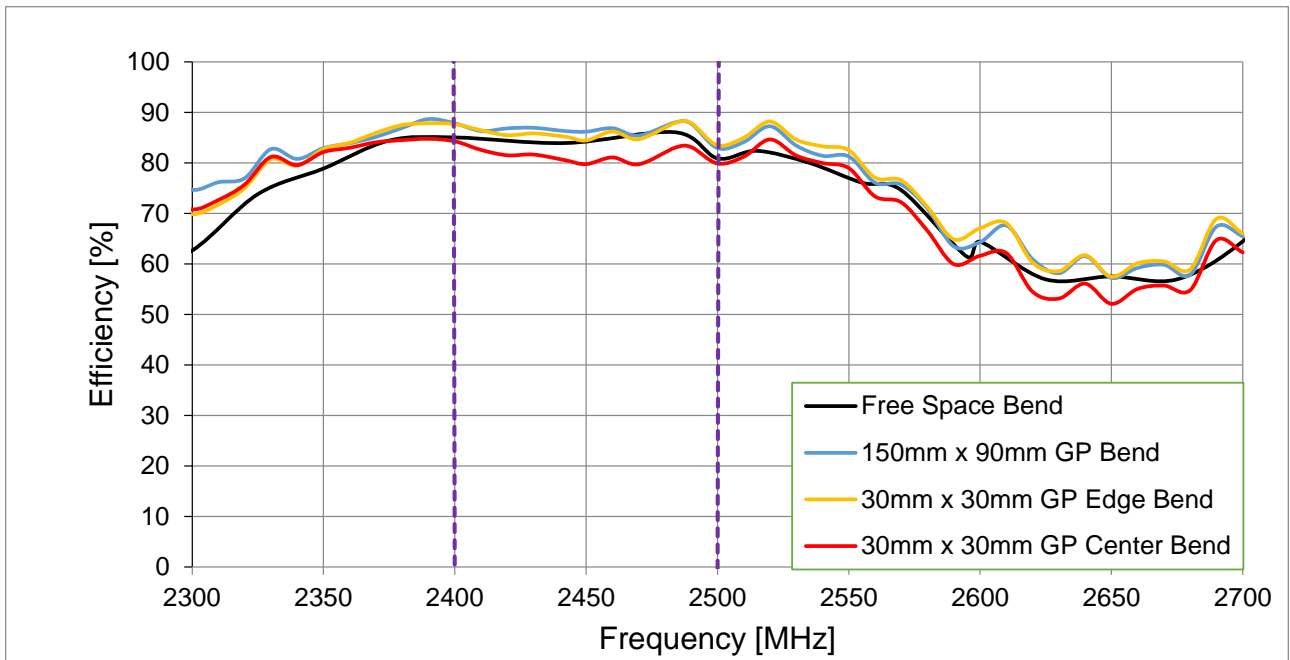

6.9 Peak Gain (90° Bend)

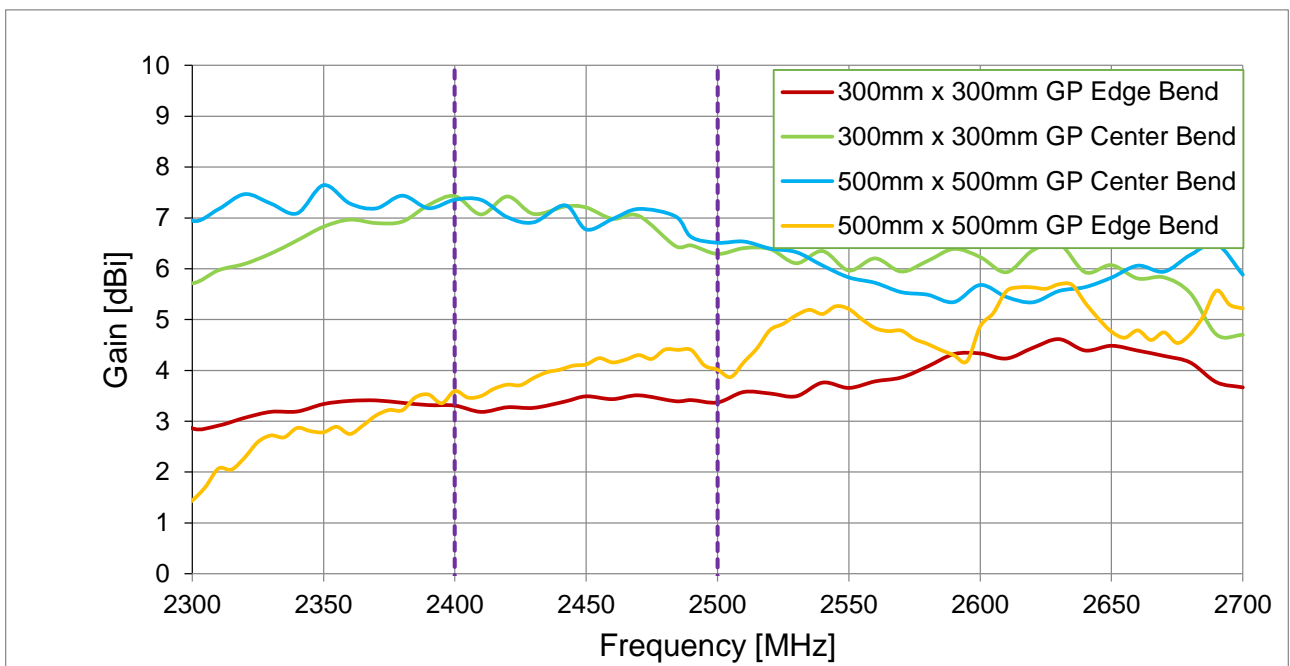
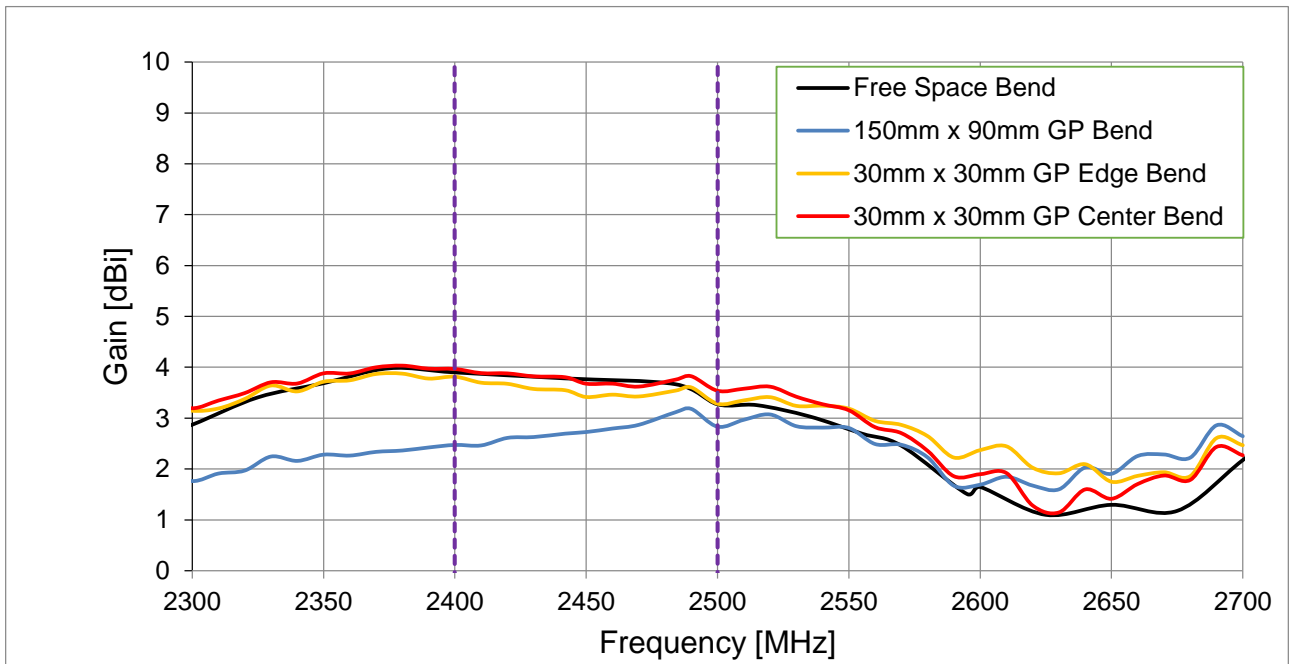



6.10 Average Gain (90° Bend)

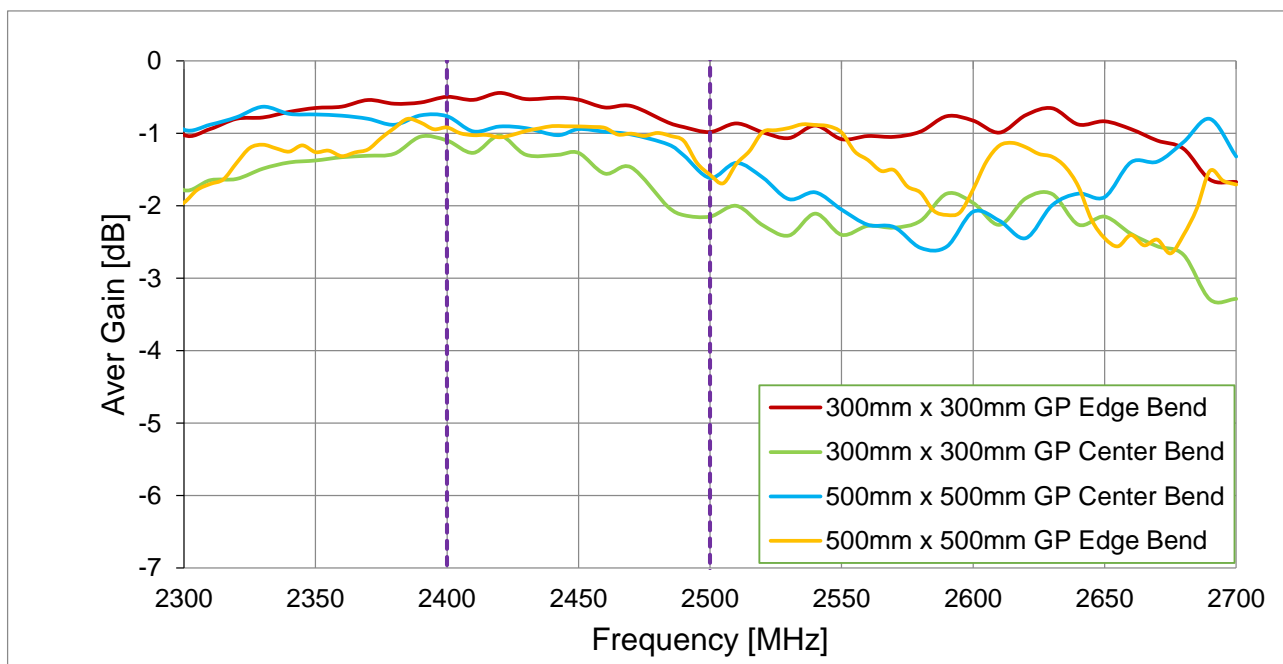
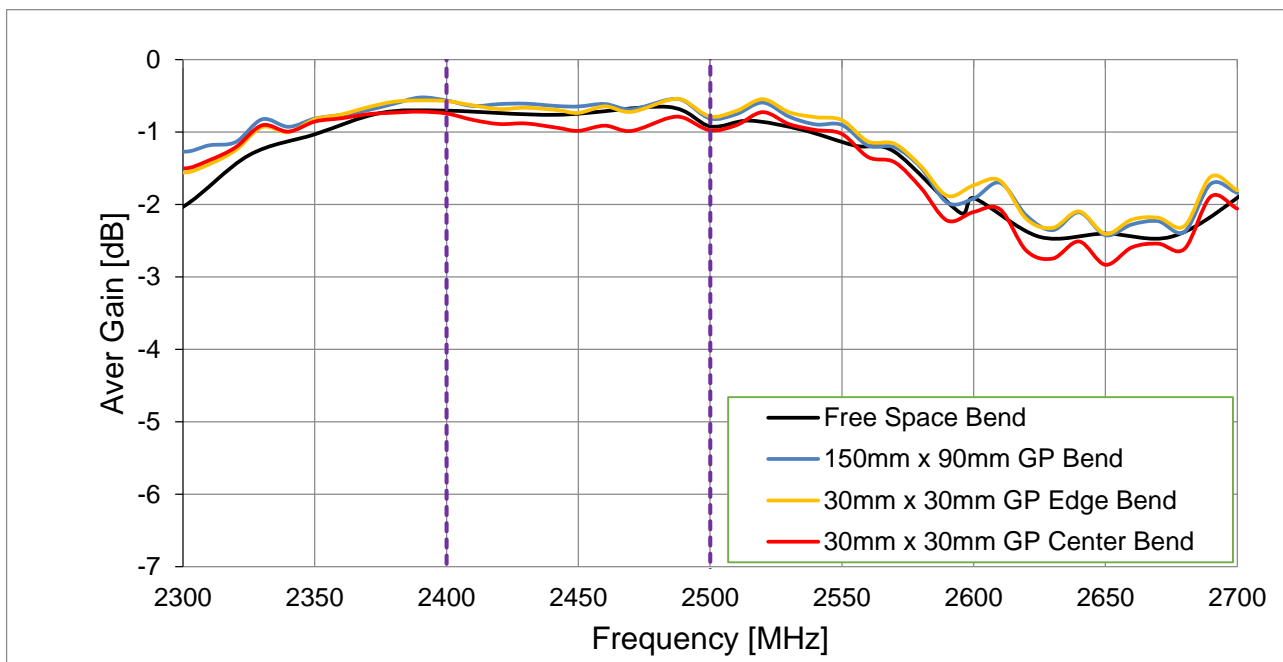

7. Radiation Patterns

7.1 GW.15 Straight at 2.4GHz

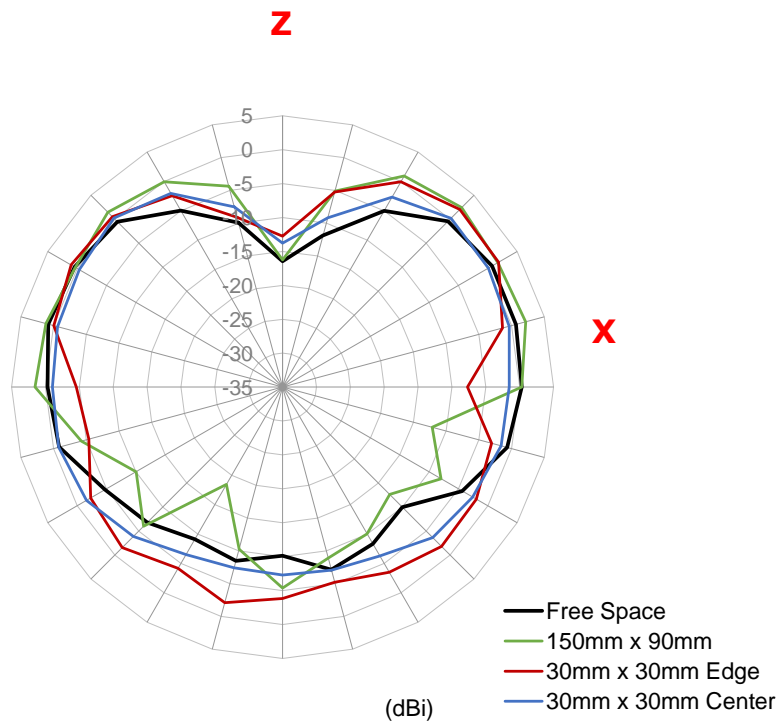
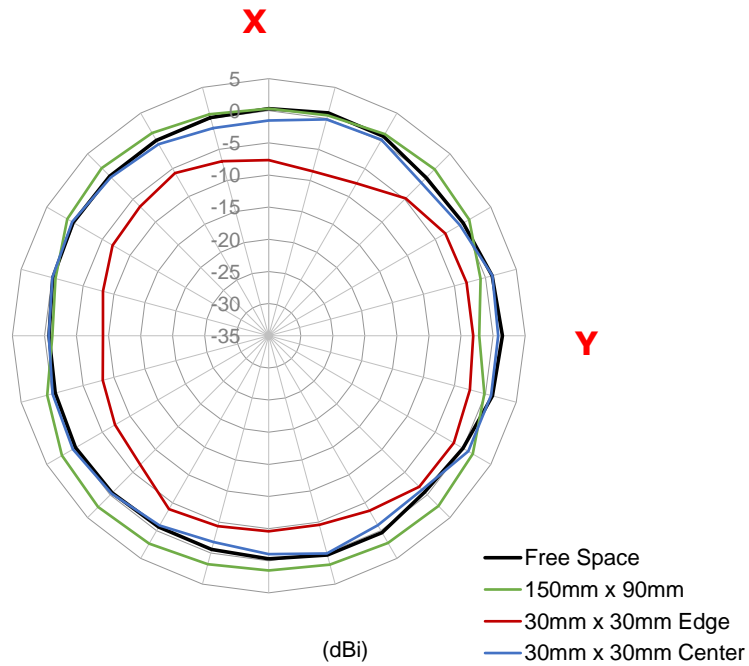

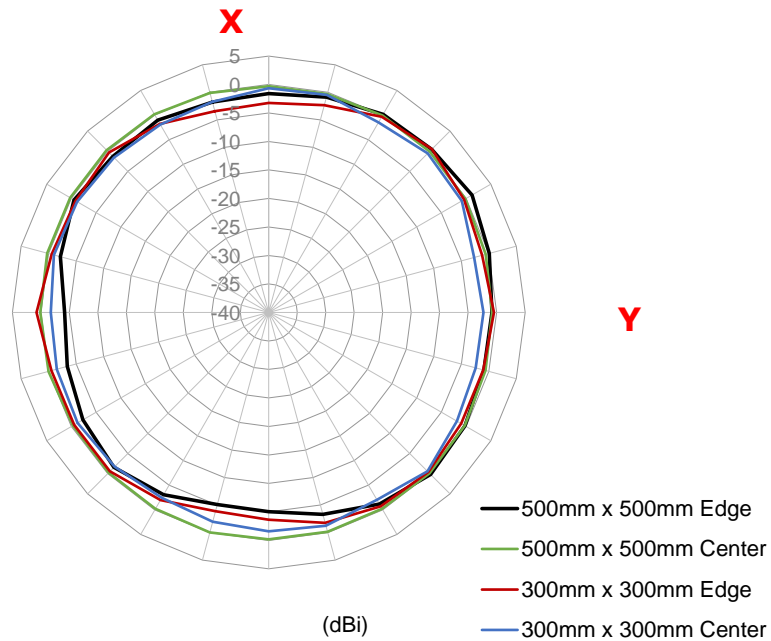
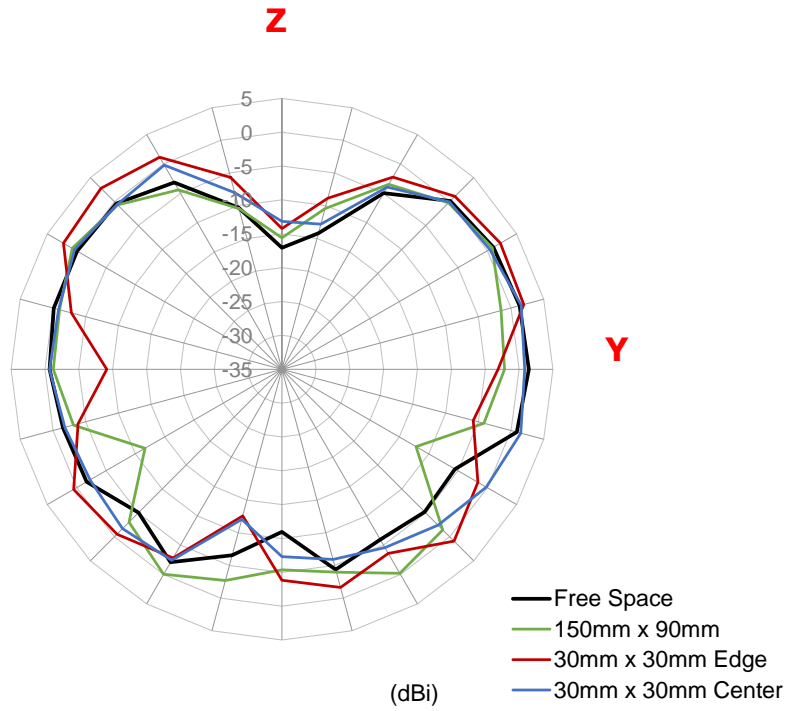

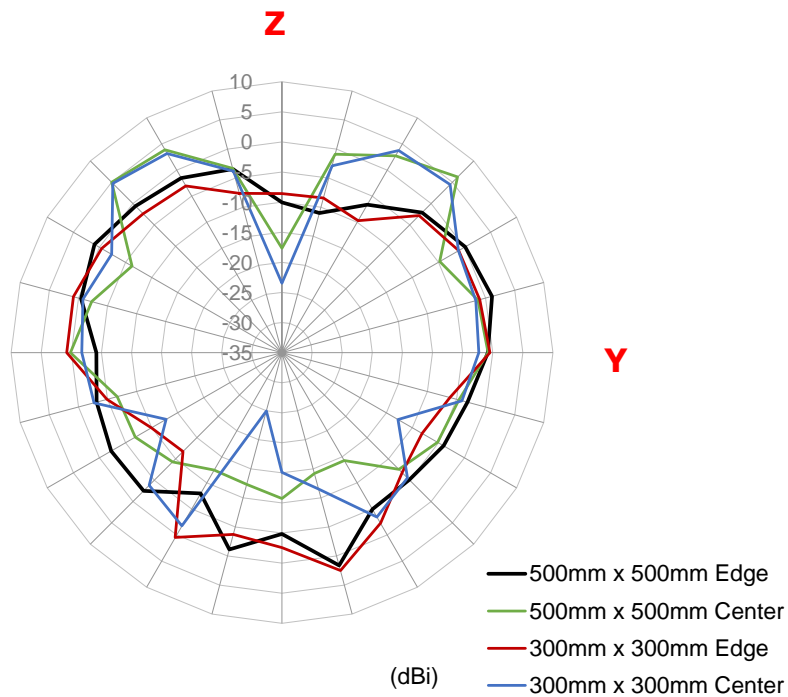
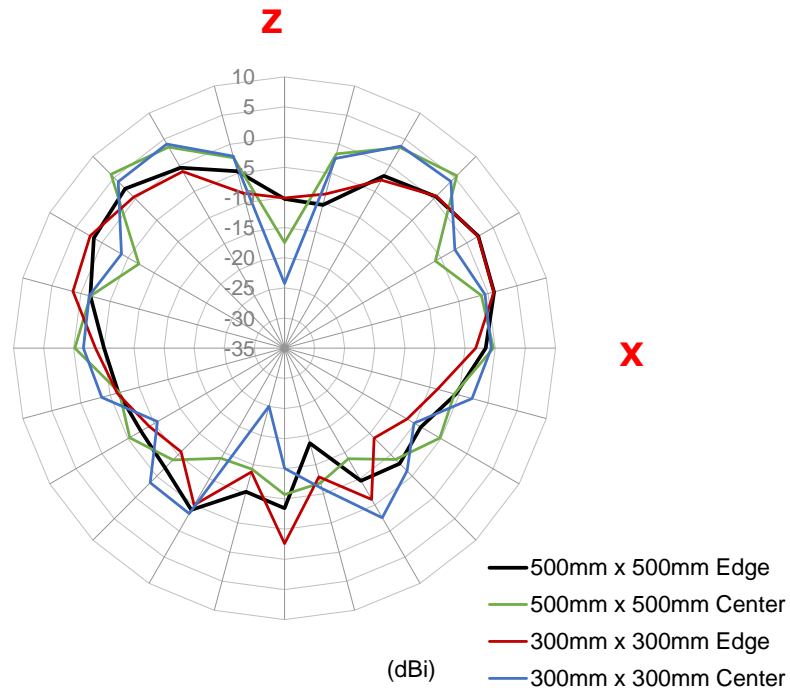

7.2 GW.15 Straight at 2.45GHz

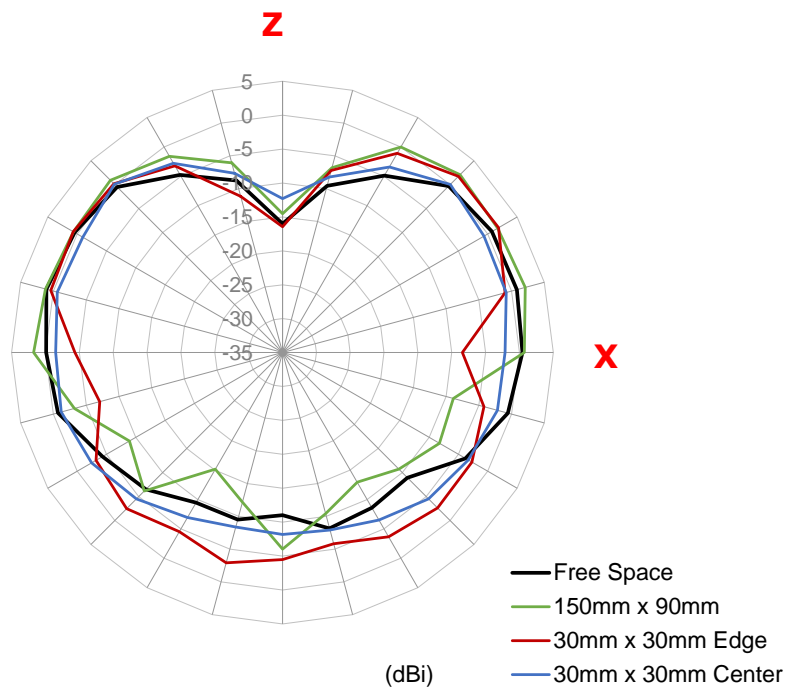
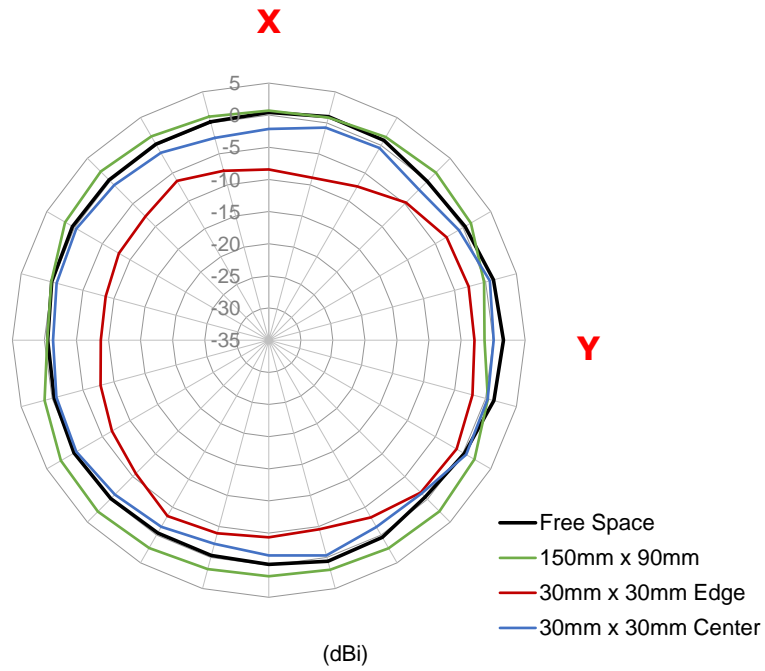

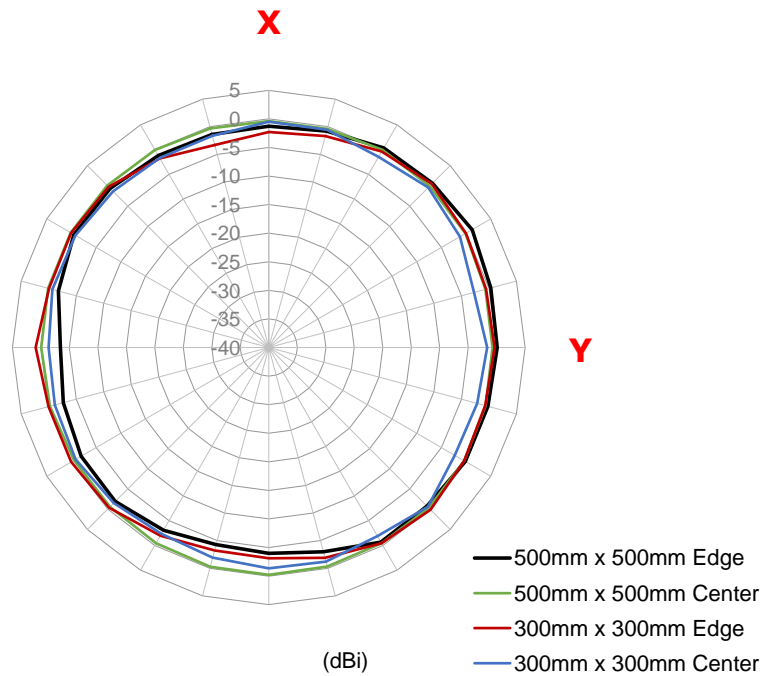
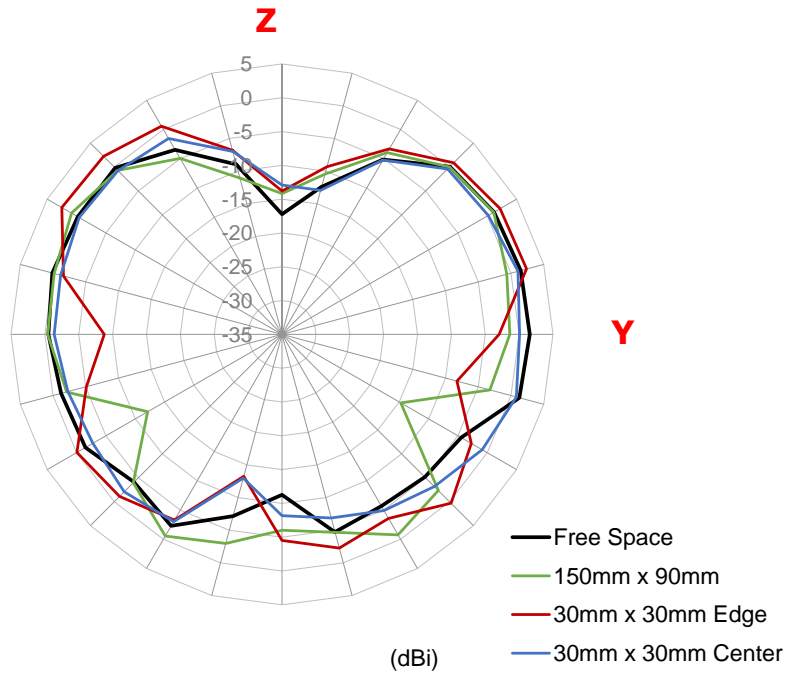

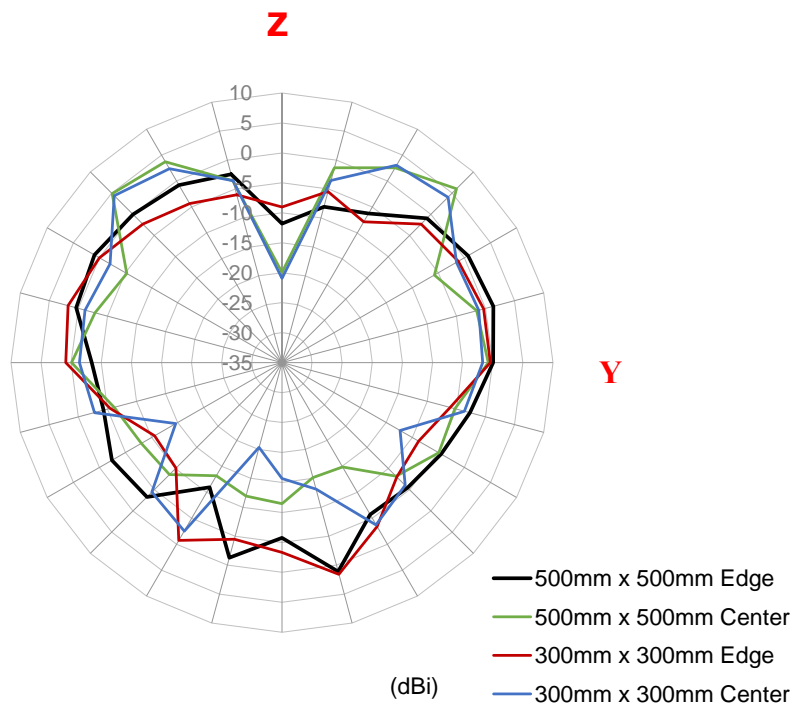
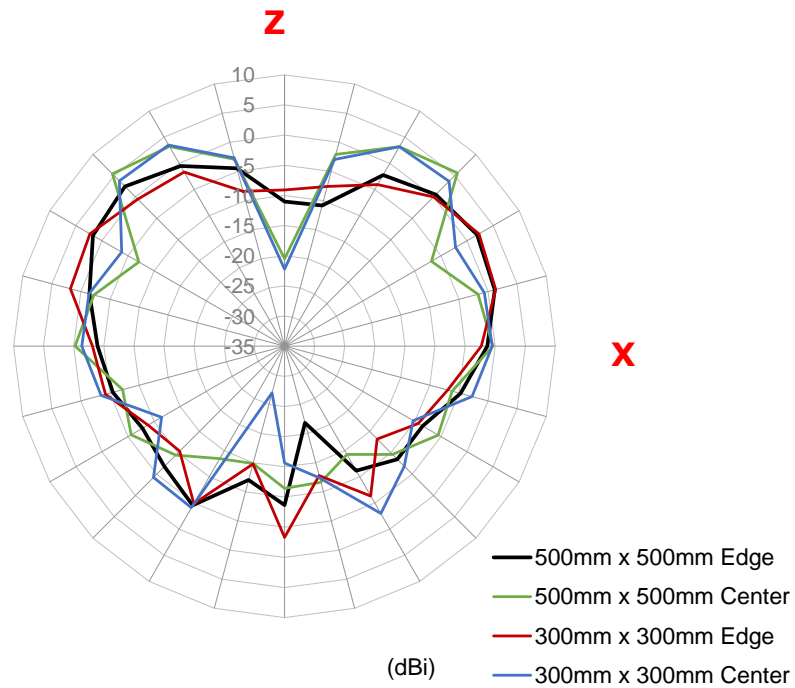

7.3 GW.15 Straight at 2.5GHz

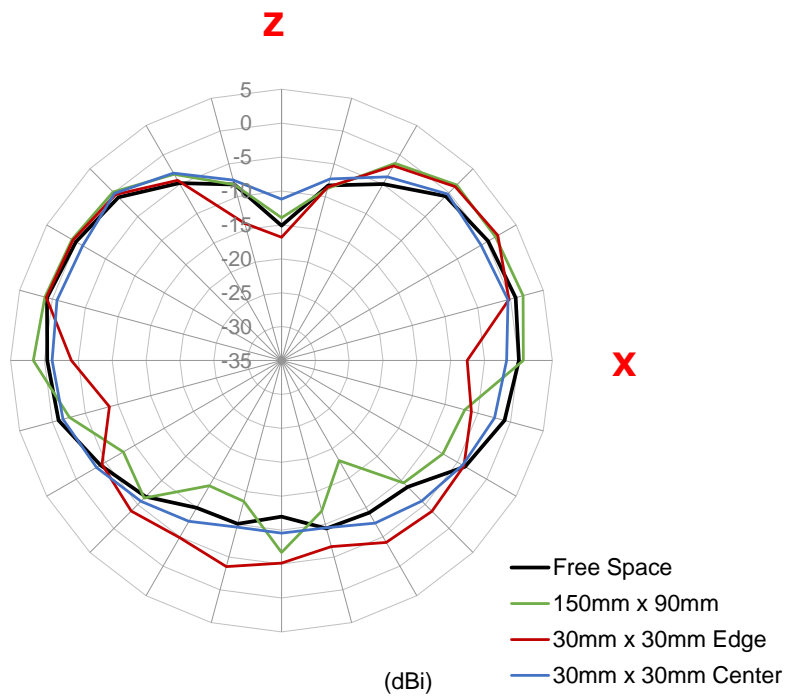
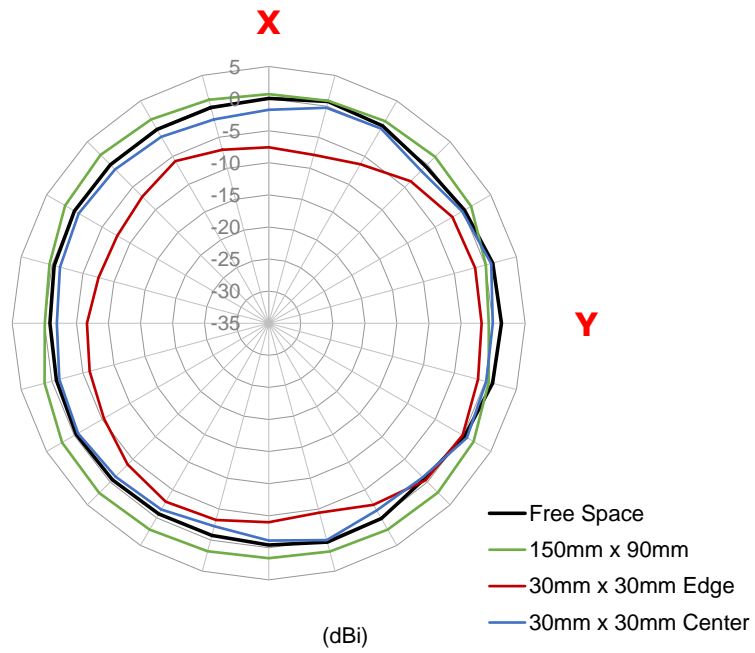

Z

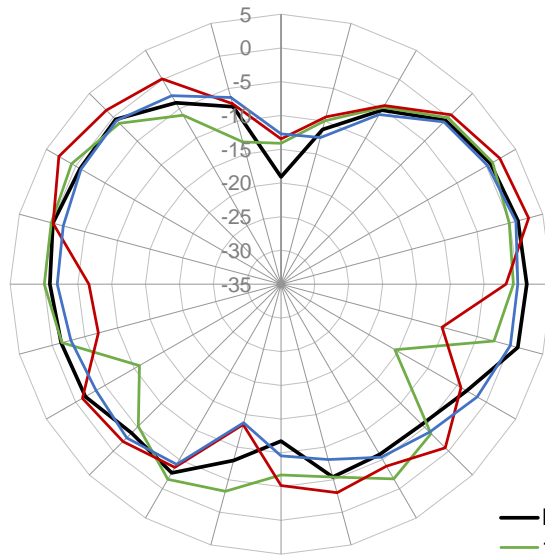

Y

- Free Space
 - 150mm x 90mm
 - 30mm x 30mm Edge
 - 30mm x 30mm Center
- (dBi)

X

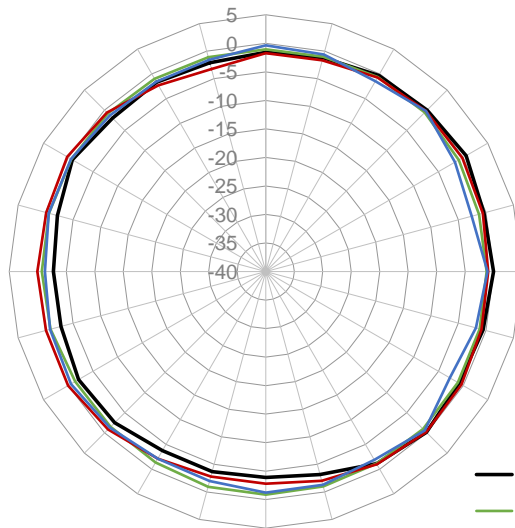

Y

- 500mm x 500mm Edge
 - 500mm x 500mm Center
 - 300mm x 300mm Edge
 - 300mm x 300mm Center
- (dBi)

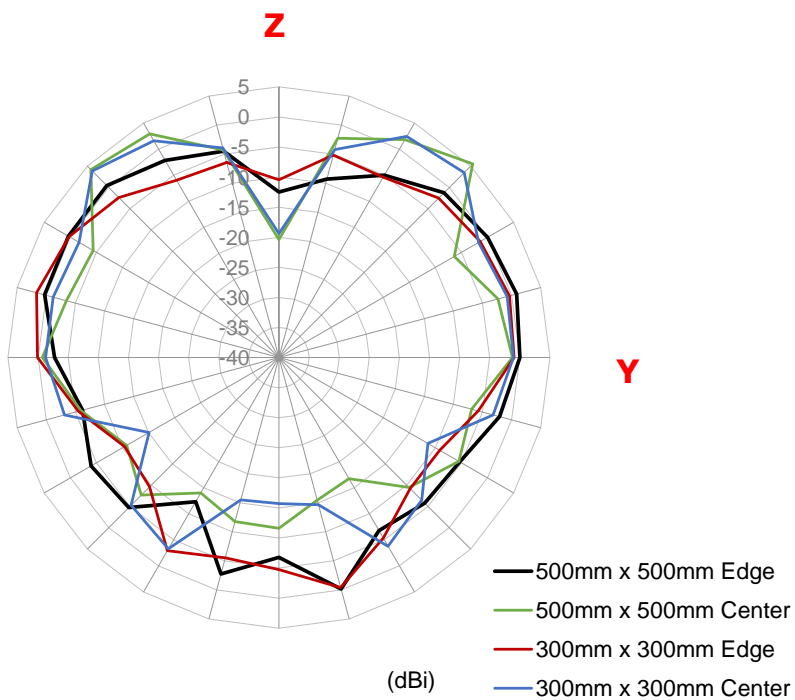
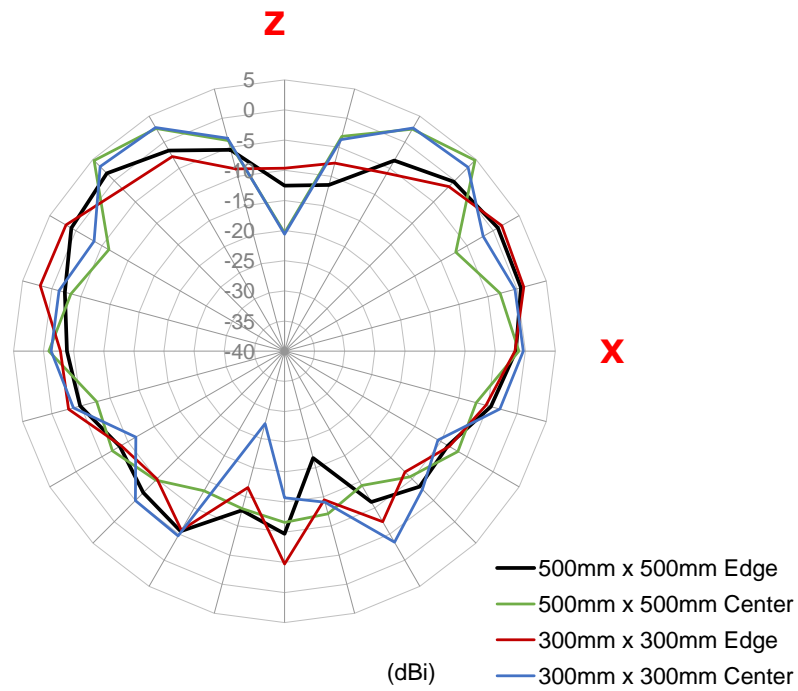



7.4 GW.15 90° Bend at 2.4GHz

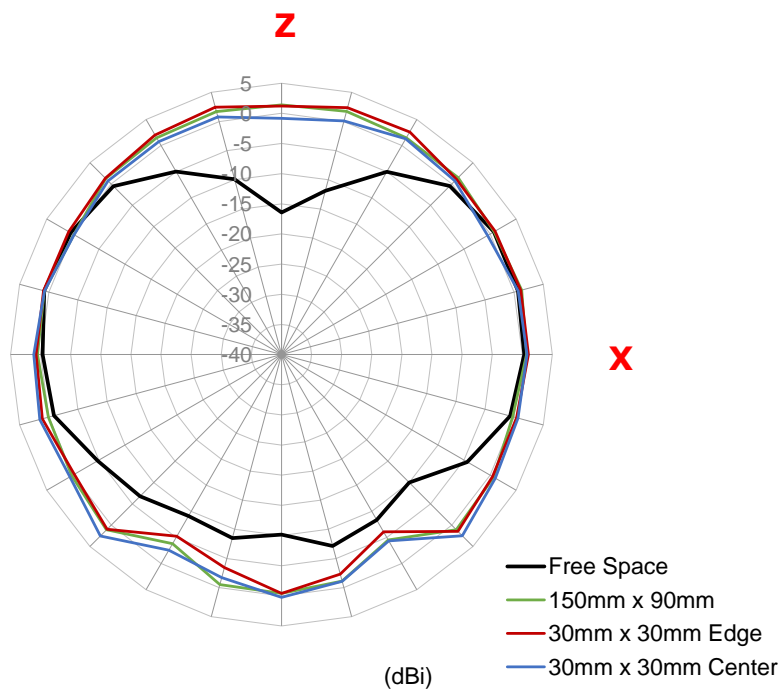
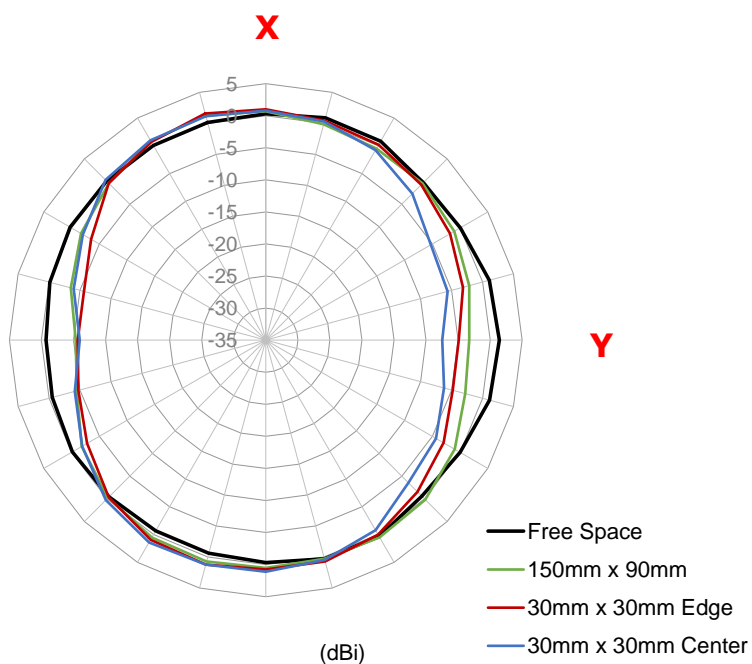

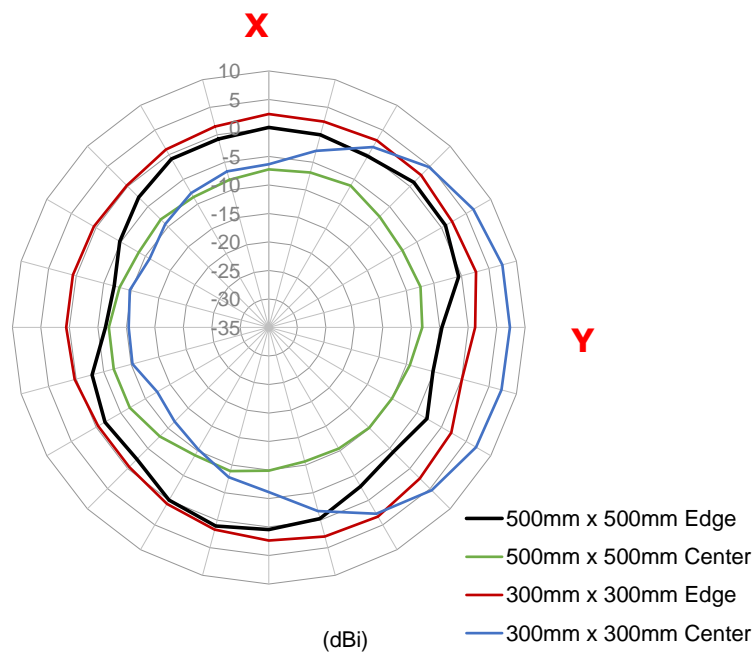
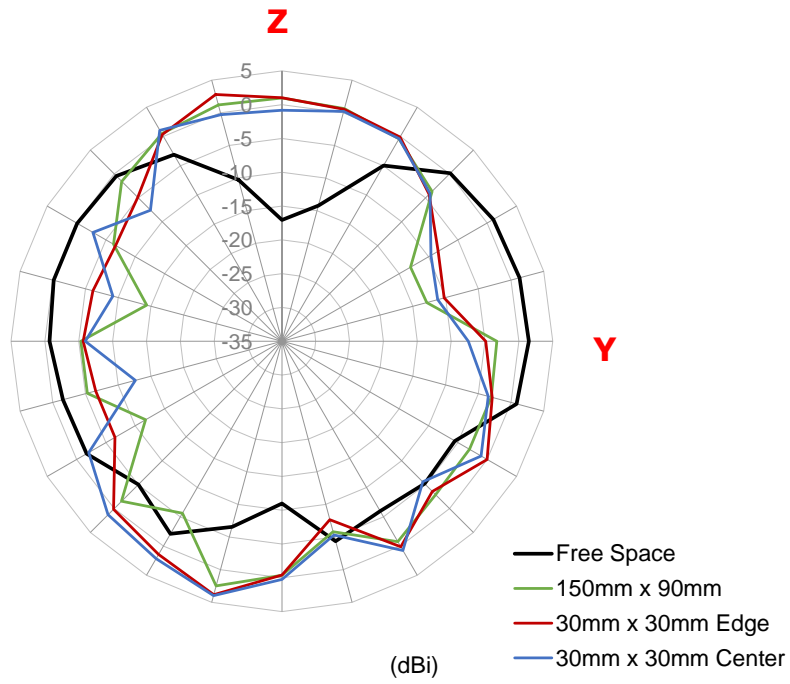

Z

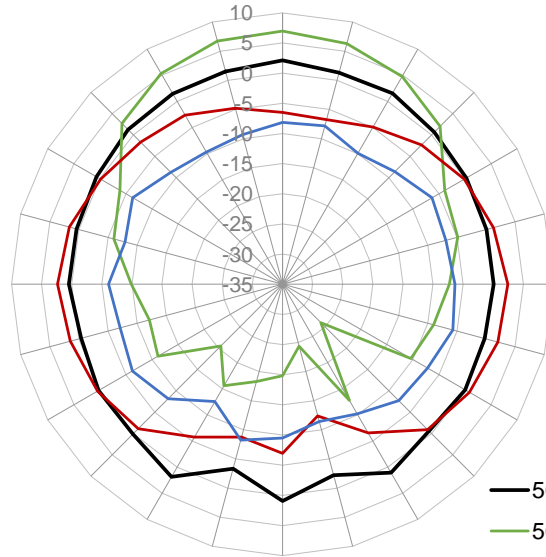

X

- 500mm x 500mm Edge
 - 500mm x 500mm Center
 - 300mm x 300mm Edge
 - 300mm x 300mm Center
- (dBi)

Z

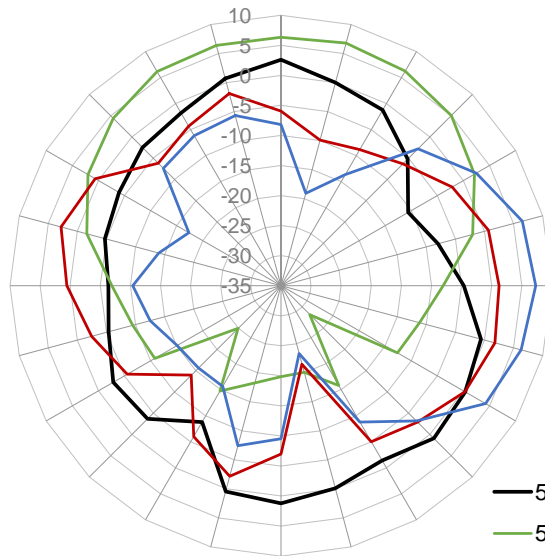

Y

- 500mm x 500mm Edge
 - 500mm x 500mm Center
 - 300mm x 300mm Edge
 - 300mm x 300mm Center
- (dBi)



7.5 GW.15 90° Bend at 2.45GHz

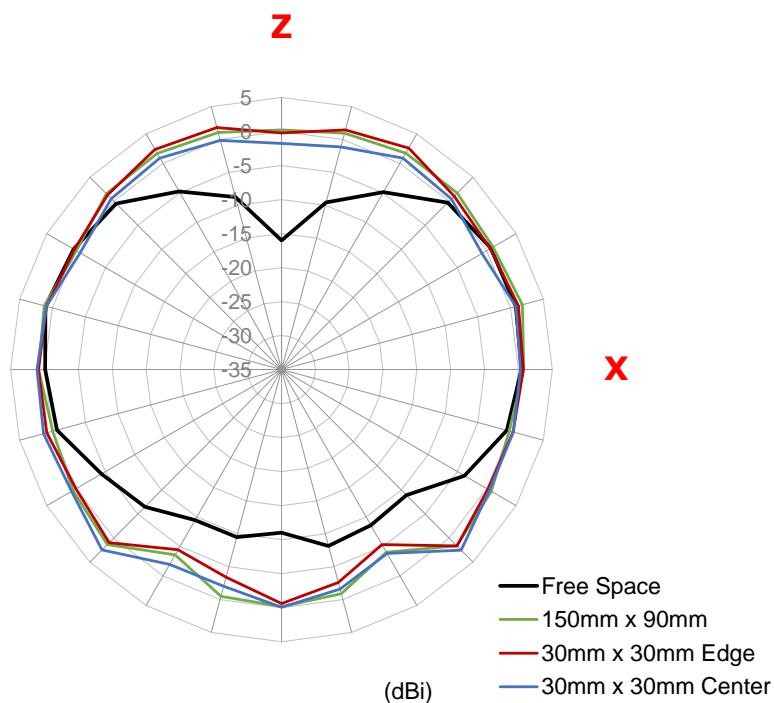
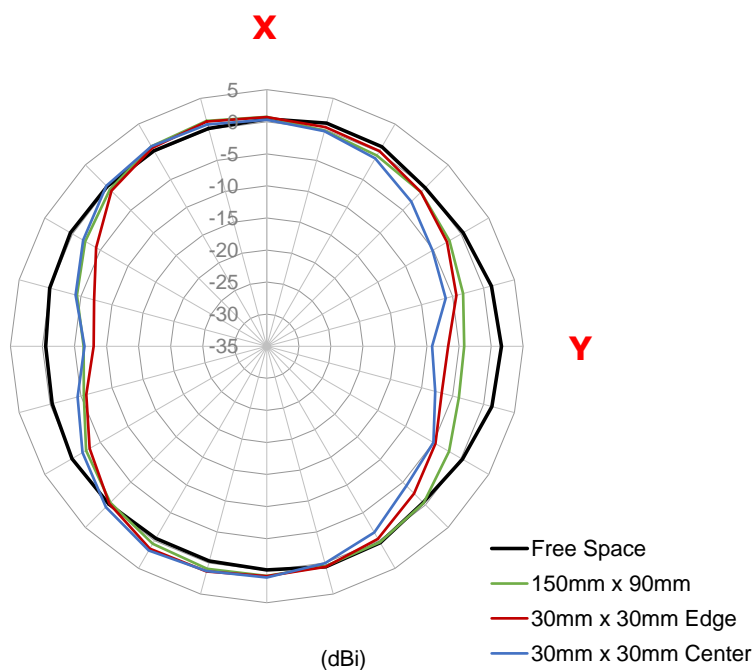

Z

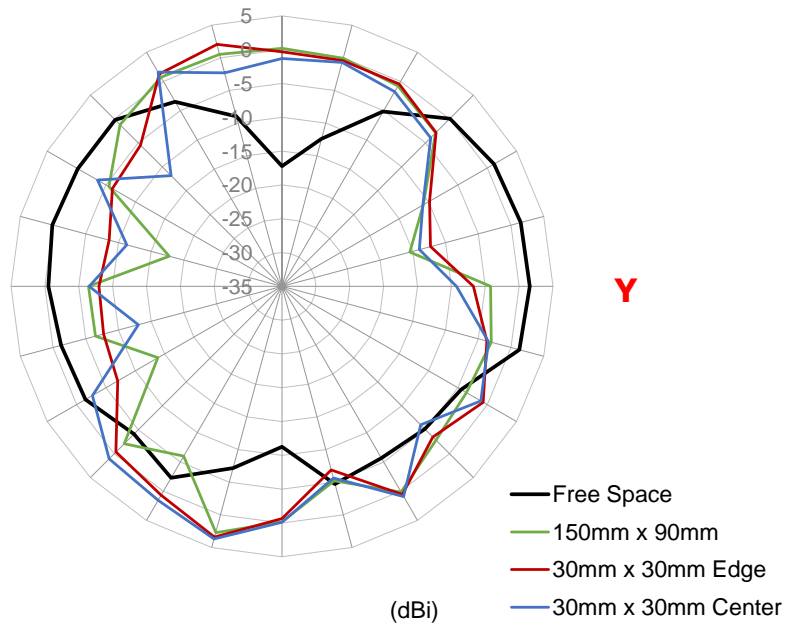

Y

X

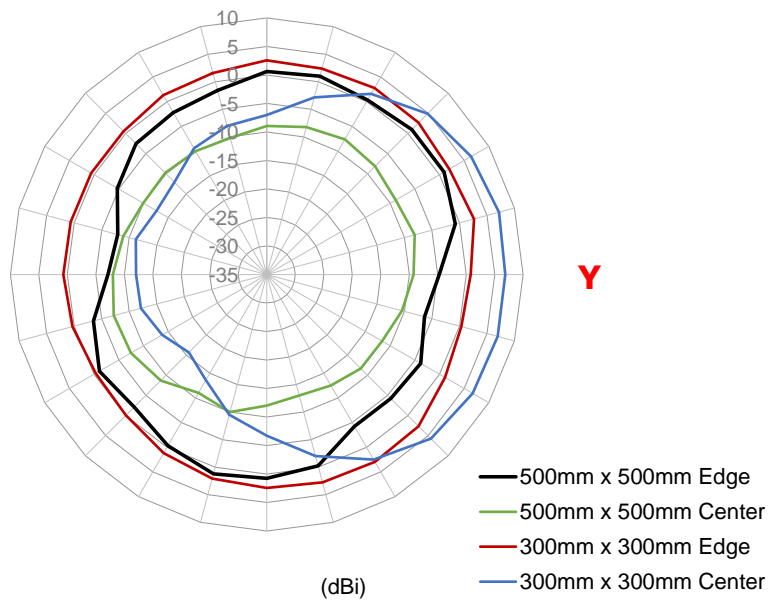

Y

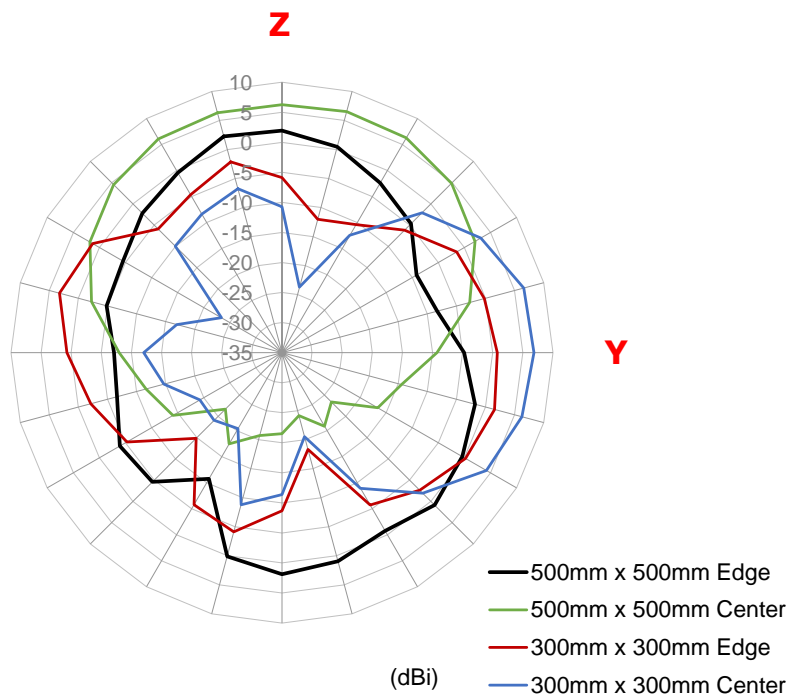
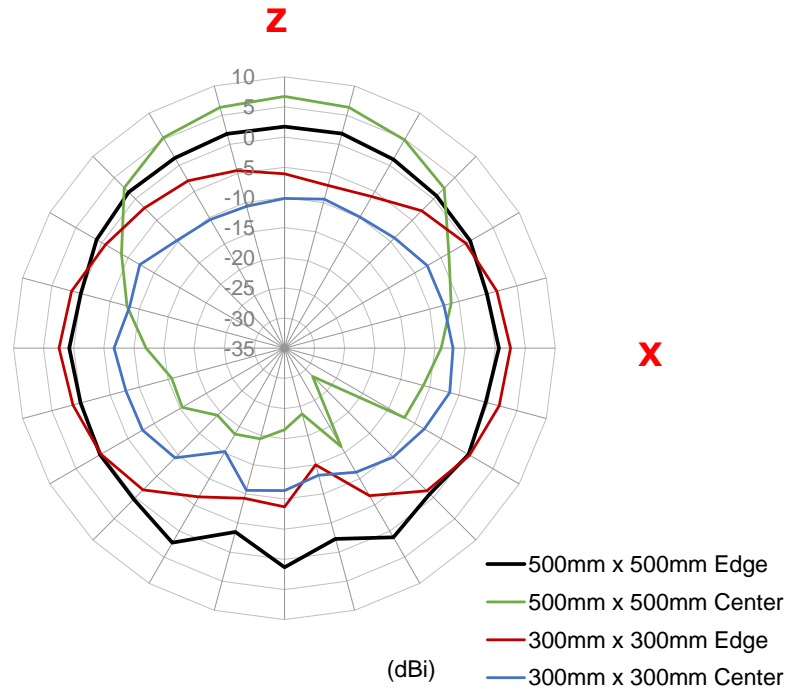



7.6 GW.15 90° at 2.5GHz

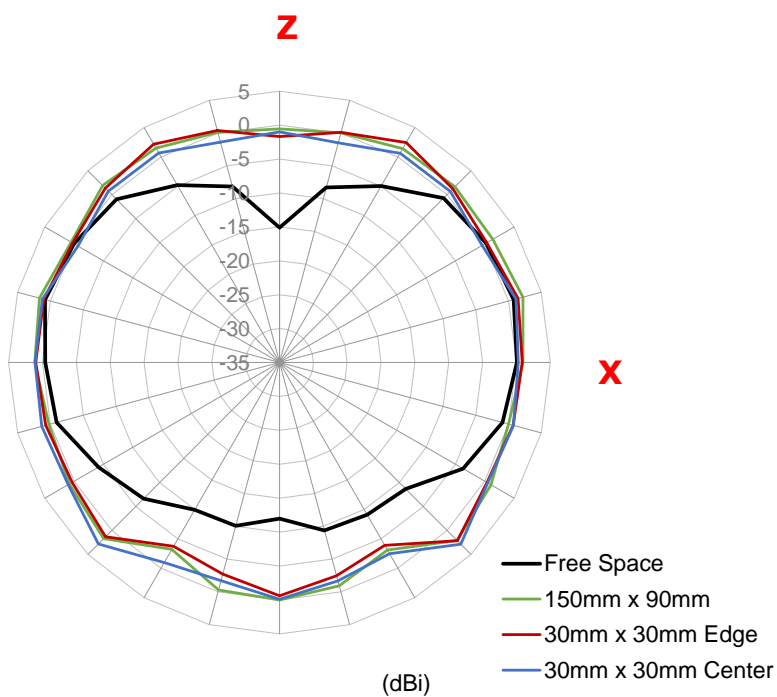
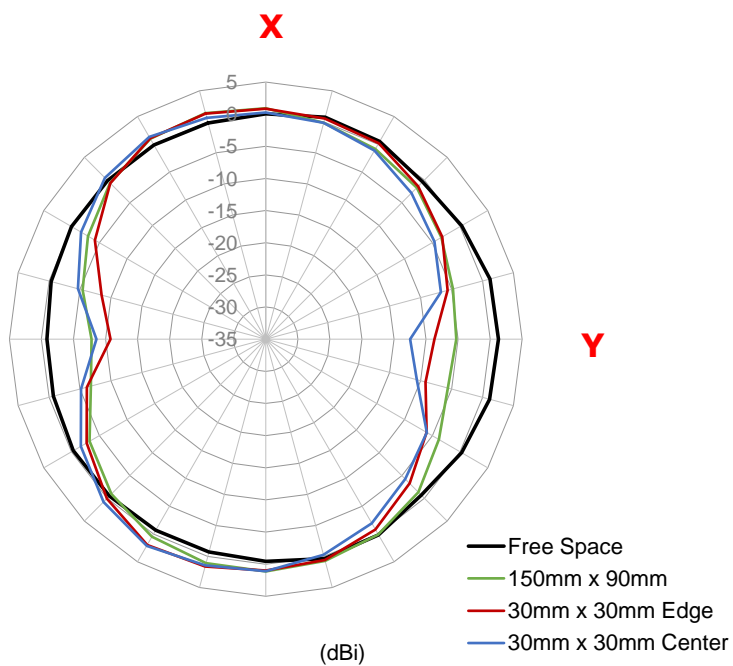

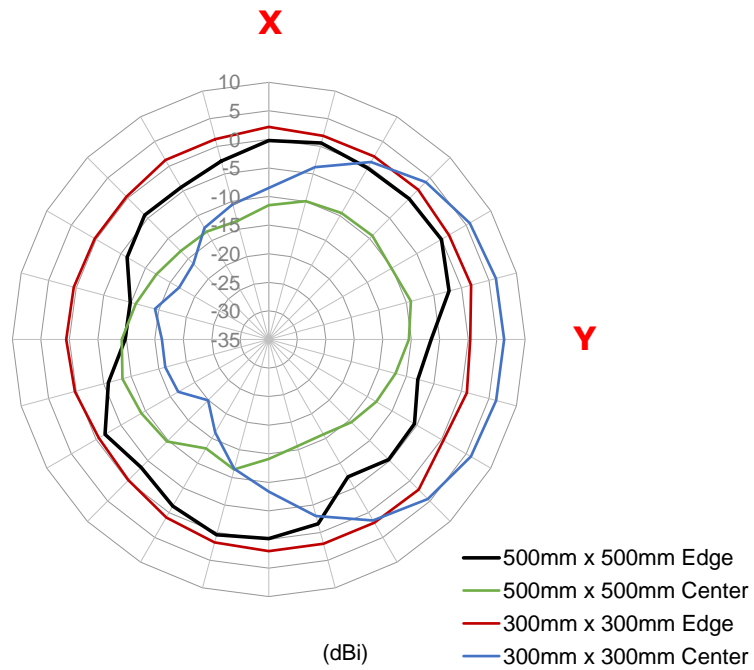
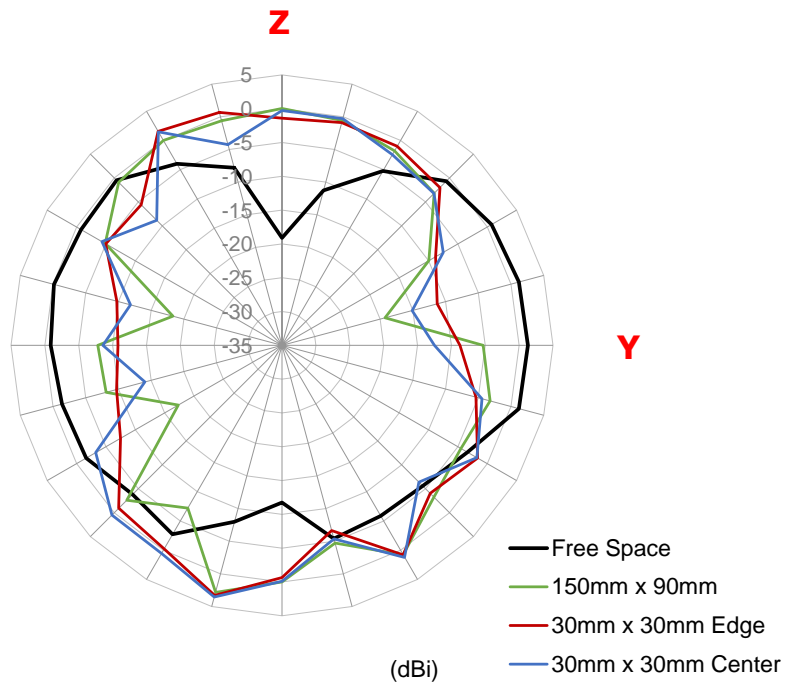

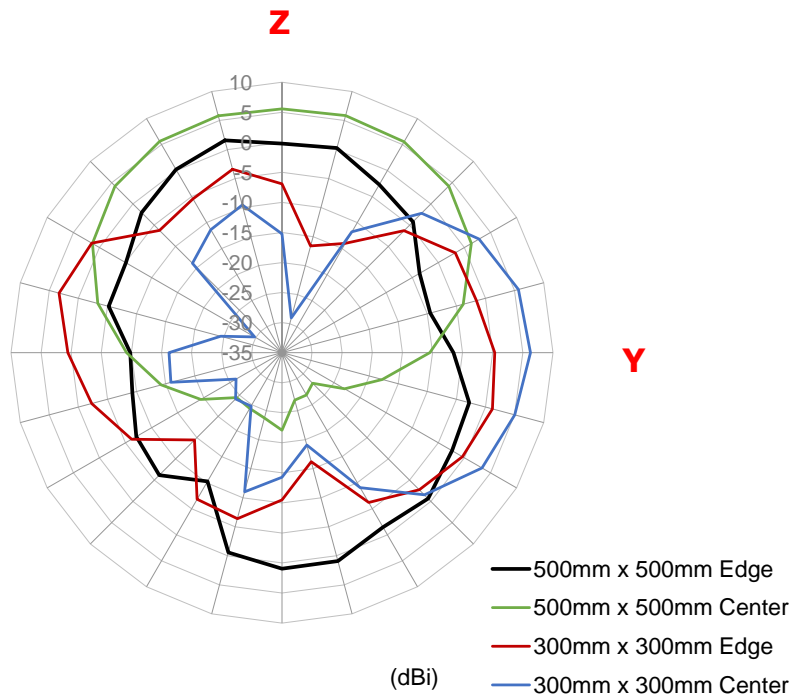
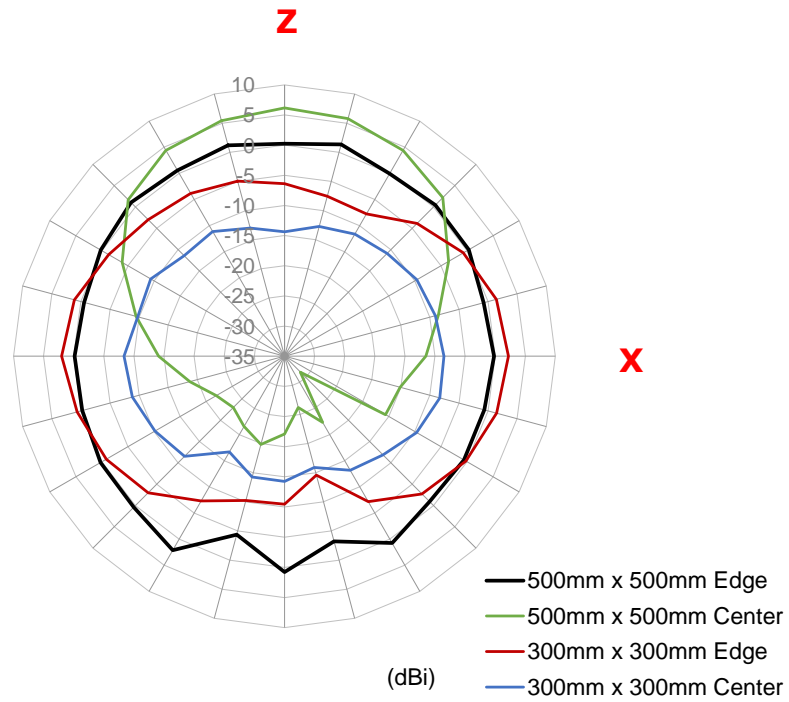

8. 3D Radiation Pattern

8.1 Free Space - Straight

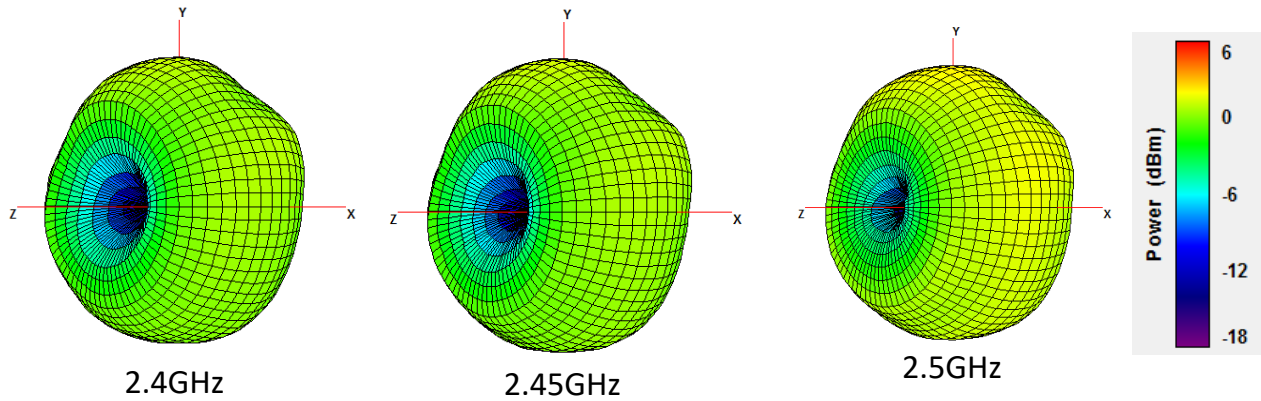

8.2 Free Space 90° Bend

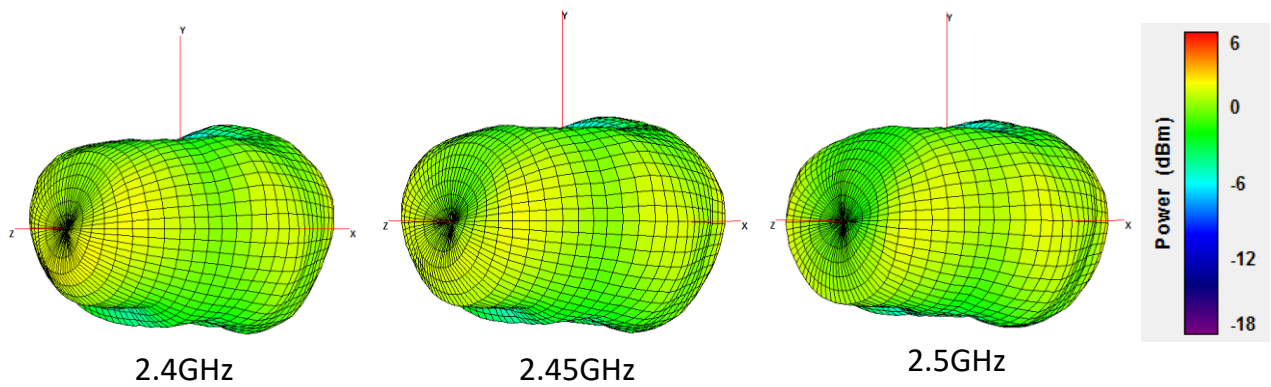

8.3 150mm x 90mm Ground Plane Straight

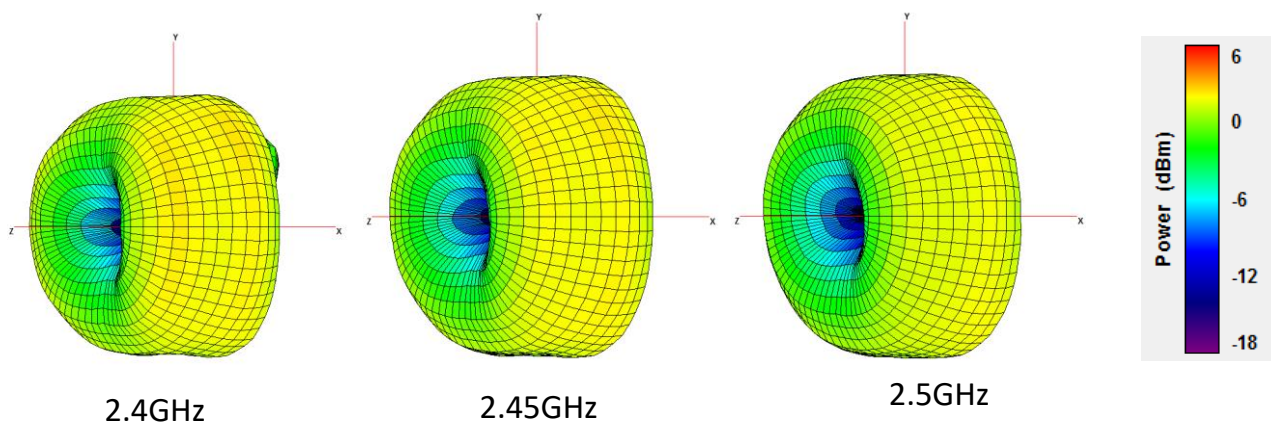



8.4 150mm x 90mm Ground Plane 90° Bend

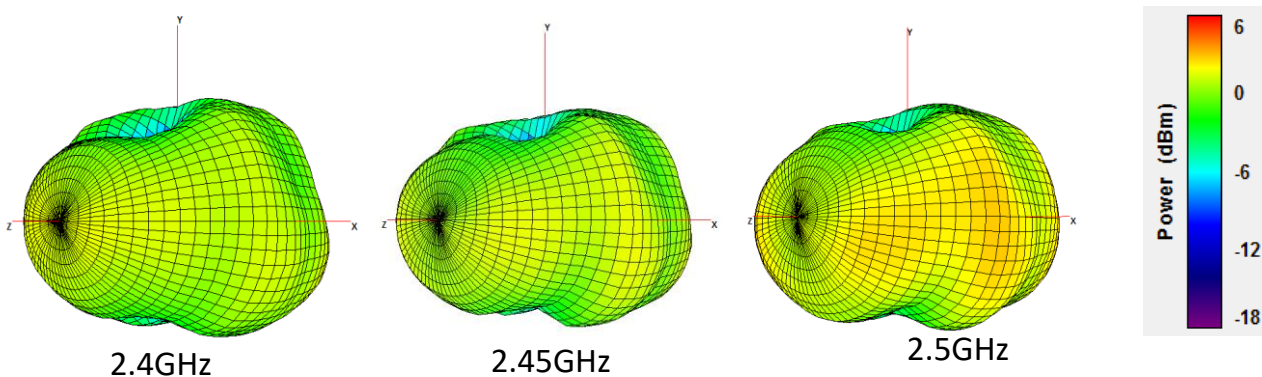

8.5 30mm x 30mm Ground Plane Straight Edge Mount

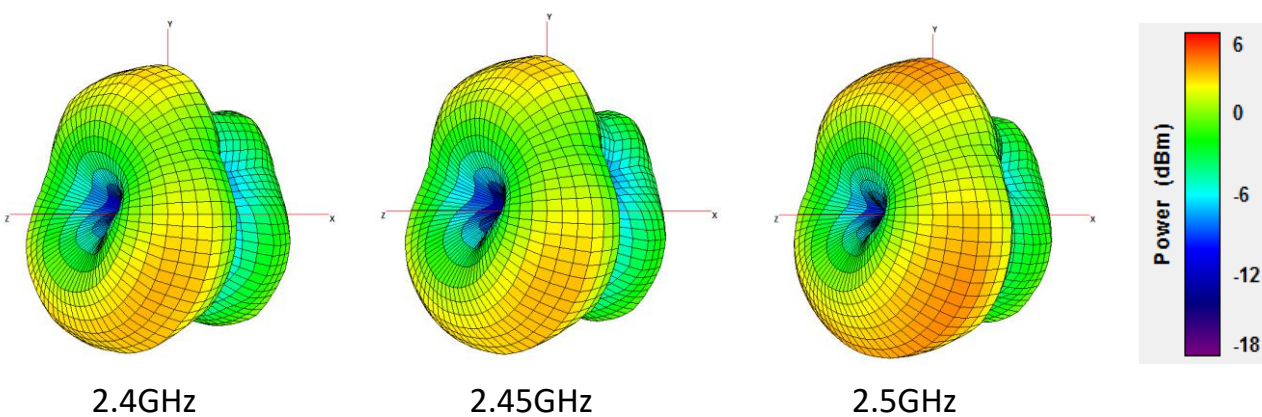

8.6 30mm x 30mm Ground Plane 90° Bend Edge Mount

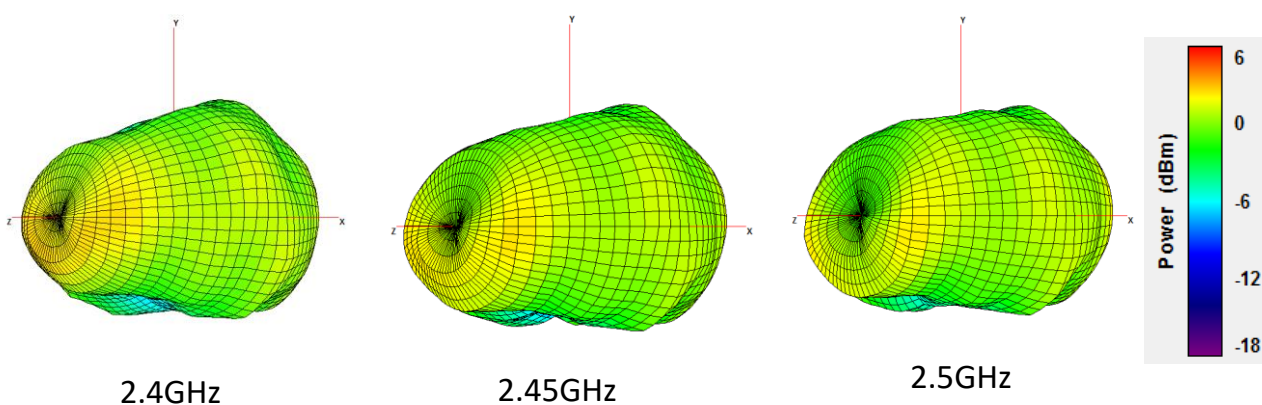



8.7 30mm x 30mm Ground Plane Straight Center Mount

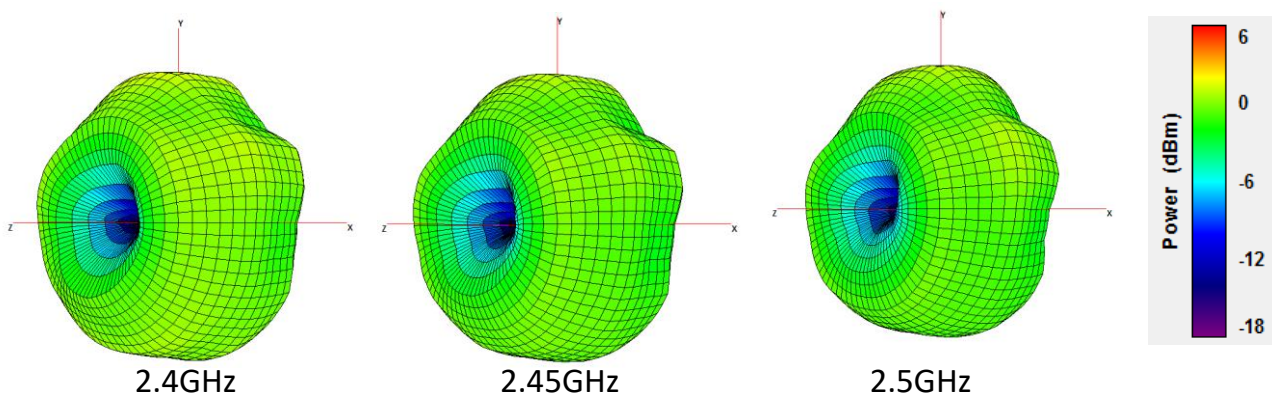

8.8 30mm x 30mm Ground Plane 90° Bend Center Mount

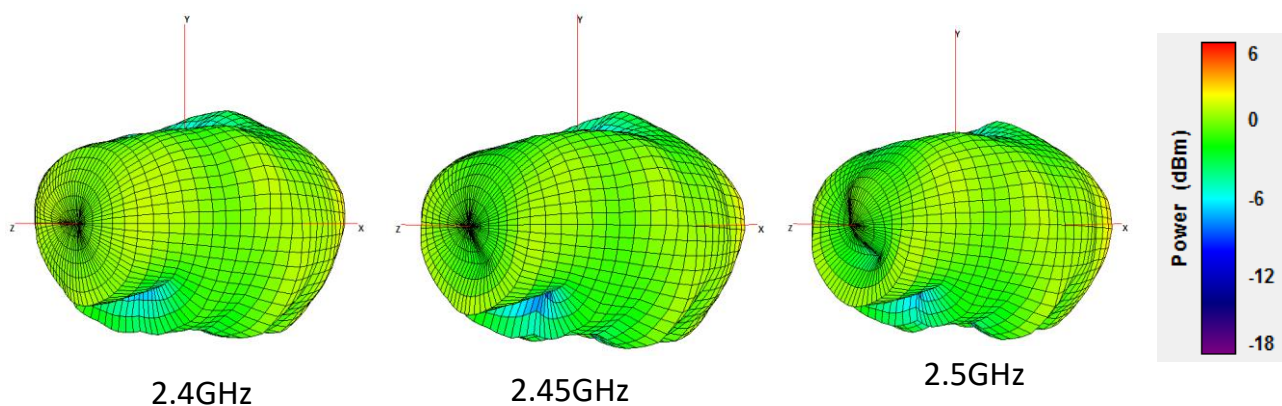

8.9 300mm x 300mm Ground Plane Straight Edge Mount

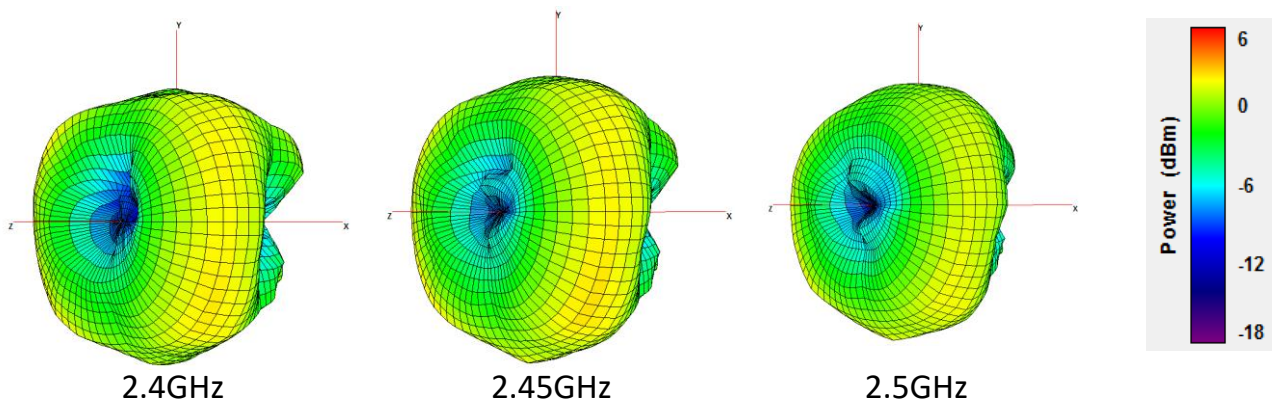



8.10 300mm x 300mm Ground Plane 90° Bend Edge Mount

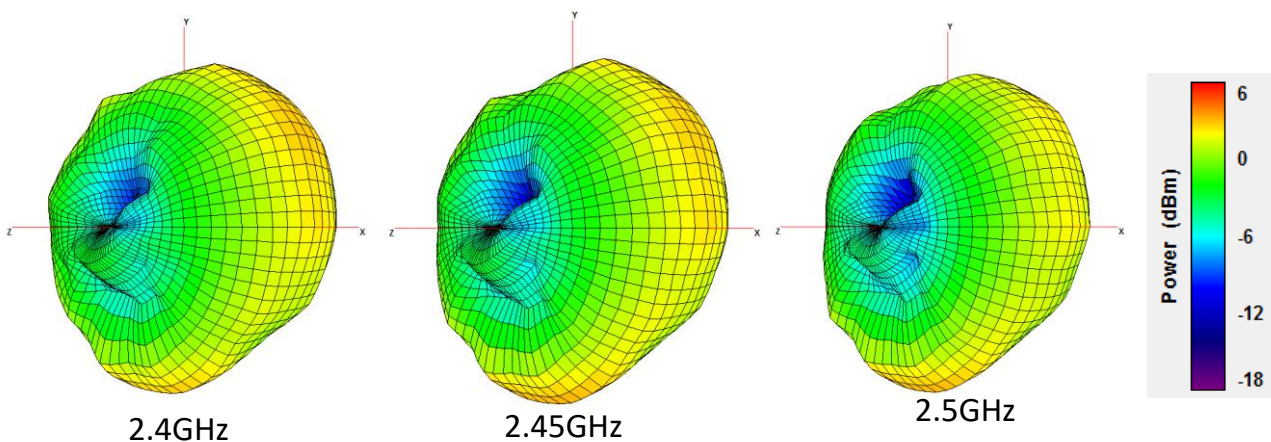

8.11 300mm x 300mm Ground Plane Straight Center Mount

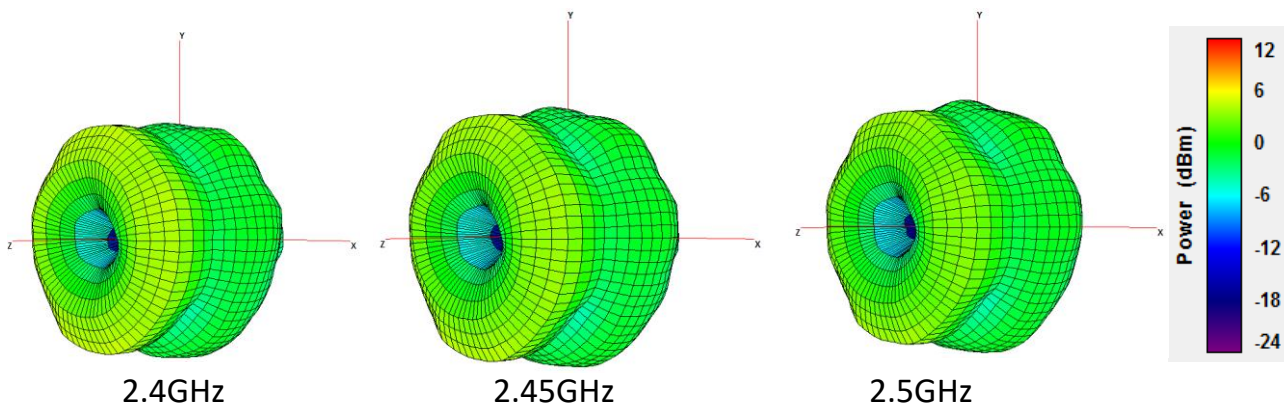

8.12 300mm x 300mm Ground Plane 90° Bend Center Mount

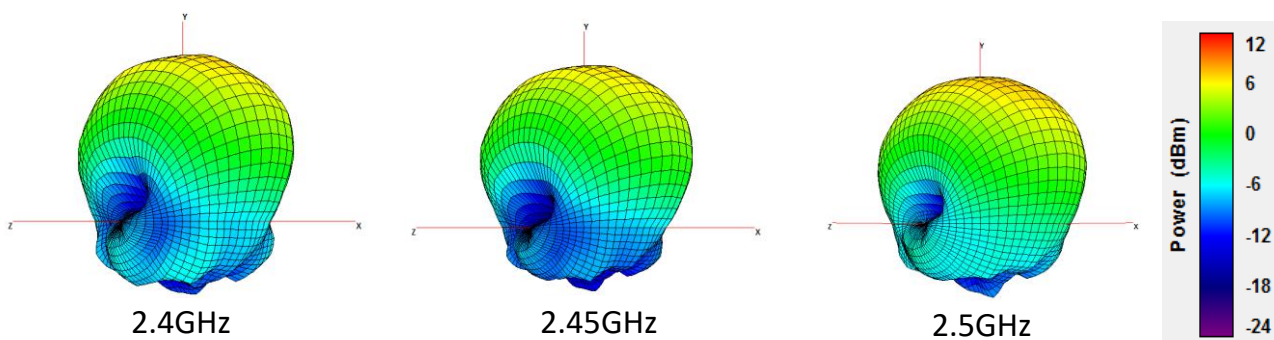



8.13 500mm x 500mm Ground Plane Straight Center Mount

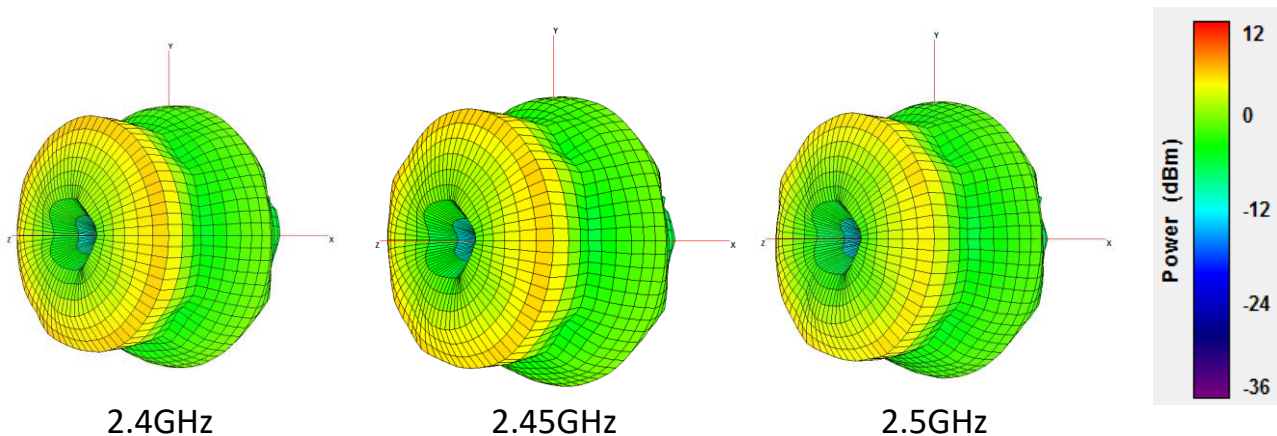

8.14 500mm x 500mm Ground Plane 90° Bend Center Mount

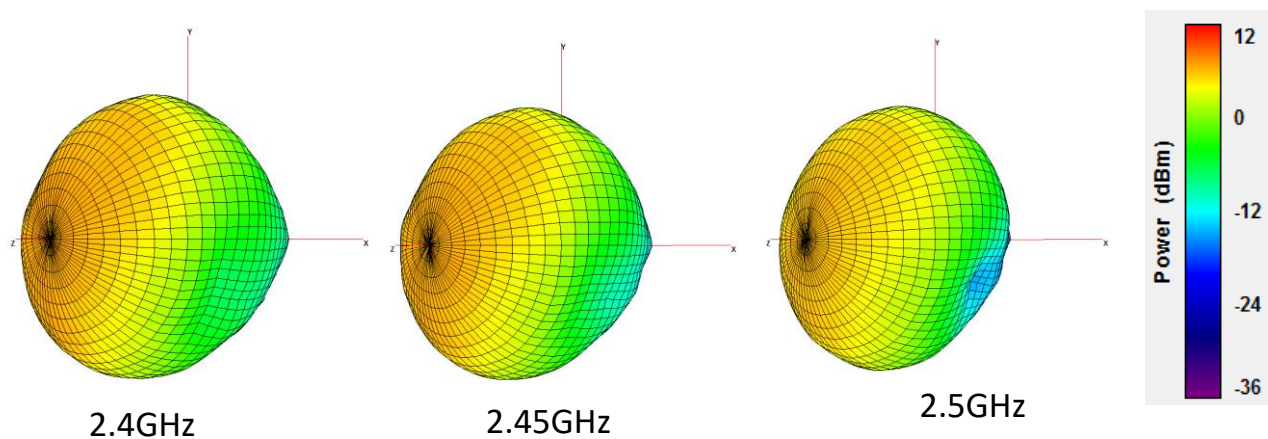

8.15 500mm x 500mm Ground Plane Straight Center Mount

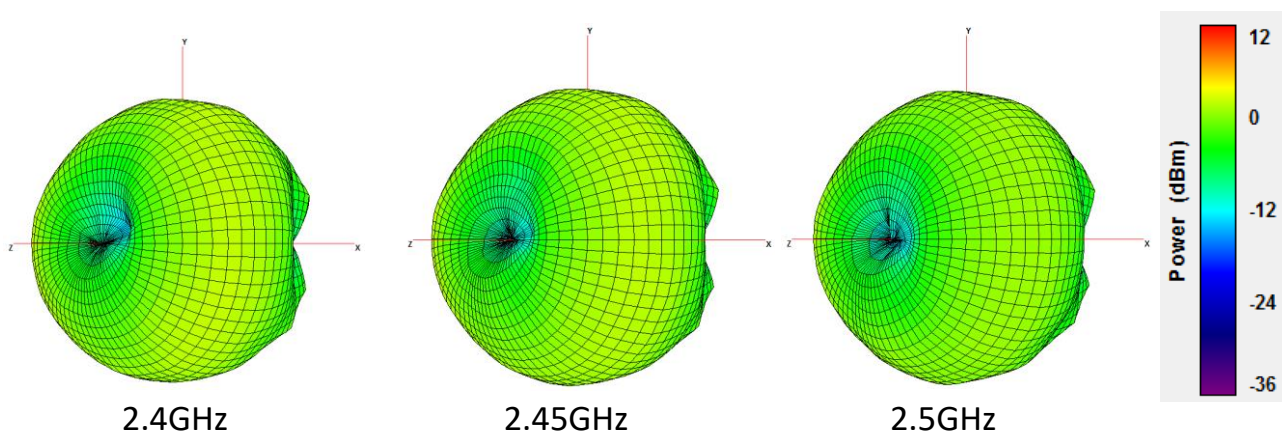



8.16500mm x 500mm Ground Plane 90° Bend Edge Mount

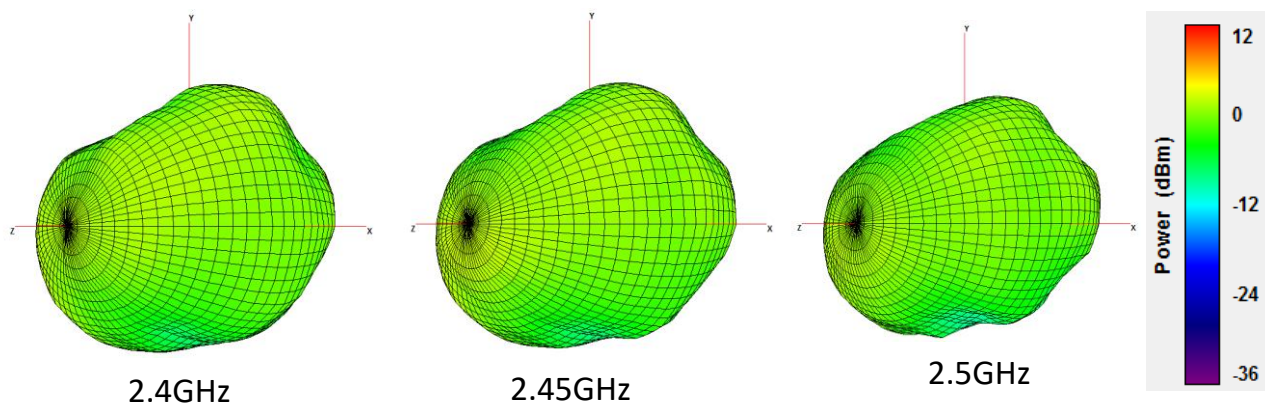



TAOGLAS

8. Drawing (Unit: mm)

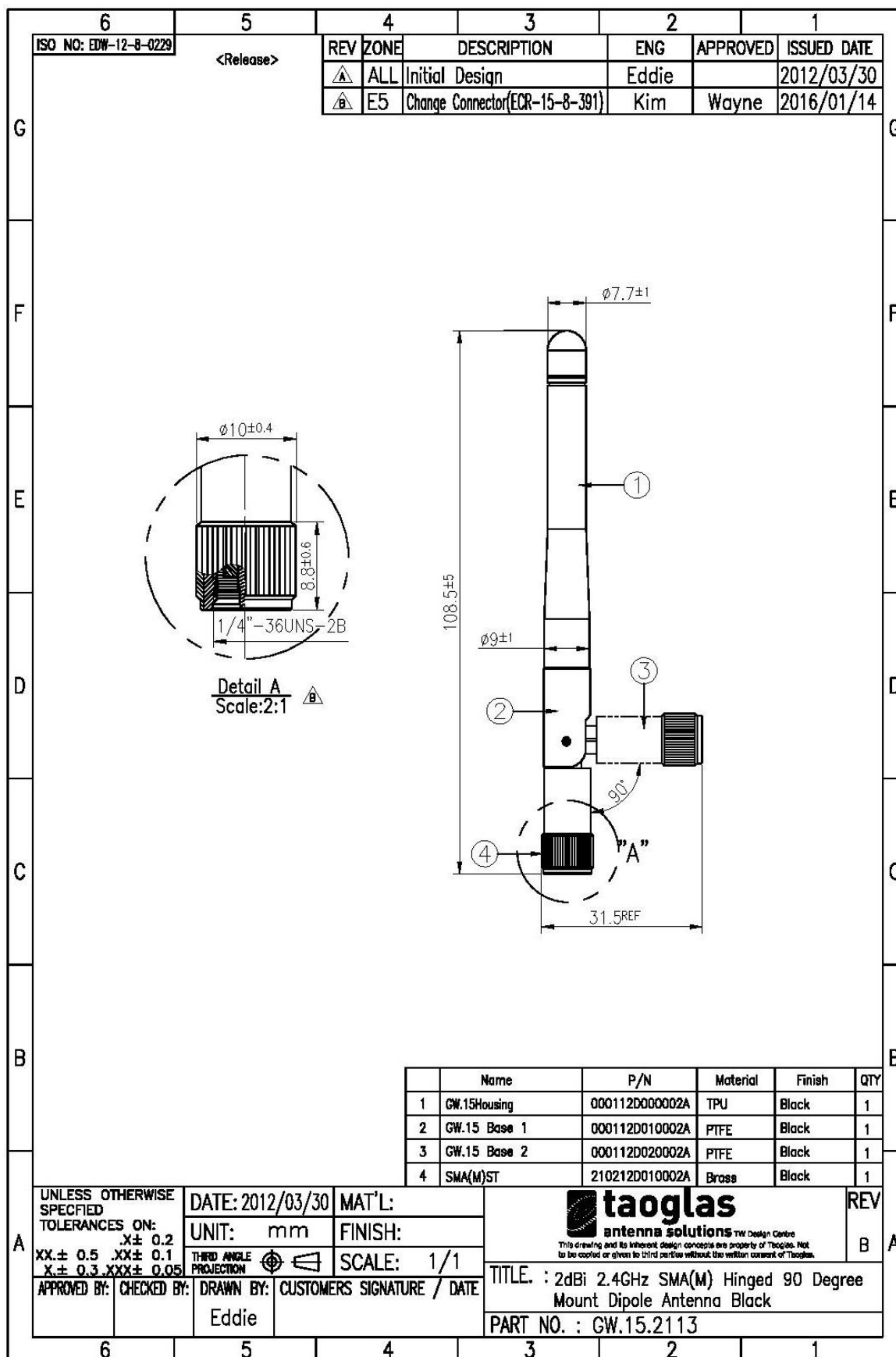



9. Packaging

GW.15.2113 Packaging Specifications

10 pcs GW.15.2113 per PE bag
PE Bag Dimensions - 100*160mm
Weight - 81g

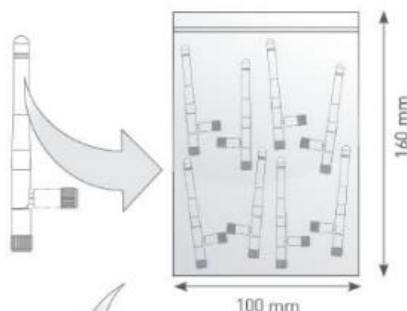

100 PE bags per large PE bag
100 pcs GW.15.2113 per large PE bags
Large PE bag Dimensions - 180*280mm
Weight - .82kg

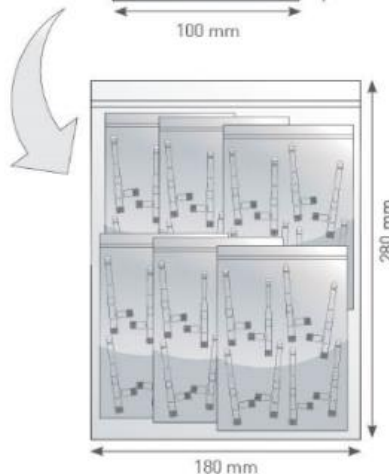

10 Large PE bags per carton
1000 pcs GW.15.2113 per carton
Carton Dimensions - 360*310*160mm
Weight - 8.2kg

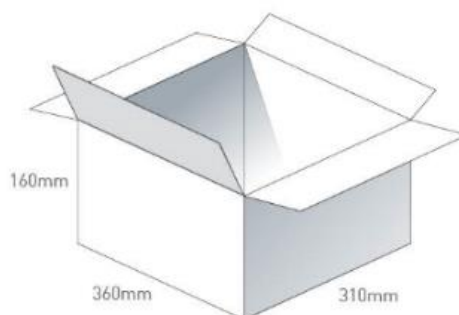

Pallet Dimensions 1200*1000*1430mm
63 Cartons per Pallet
12 Cartons per layer
6 Layers

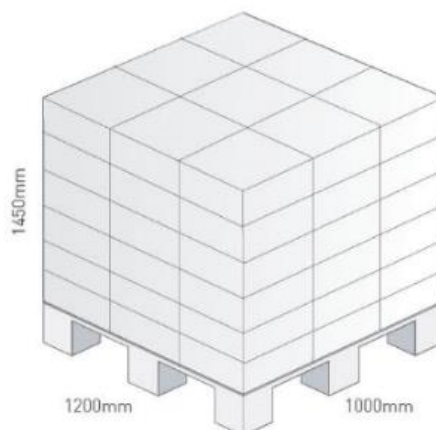

Taoglas makes no warranties based on the accuracy or completeness of the contents of this document and reserves the right to make changes to specifications and product descriptions at any time without notice. Taoglas reserves all rights to this document and the information contained herein.

Reproduction, use or disclosure to third parties without express permission is strictly prohibited.

© Taoglas