

**Customer Part:**



**Description**

- Surface mount temperature compensated voltage controlled crystal oscillator.
- Freq Adj option  
Option A (standard):  
Ageing adjustment by means of external Control Voltage applied to pad 1  
Range (frequency ≤ 20MHz) ≥ ±5ppm  
Range (frequency > 20MHz) ≥ ±7ppm  
Linearity ≤2%  
Slope Positive  
Input resistance ≥100kΩ  
Modulation bandwidth ≥2kHz  
Standard control voltage range 1.5V±1V
- Model CFPT-9301-A
- Model Issue number 7

**Frequency Parameters**

- Frequency 10.0MHz
- Frequency Tolerance ±1.00ppm
- Frequency Stability ±1.00ppm
- Operating Temperature Range -40.00 to 85.00°C
- Ageing ±1ppm max in 1st year (see Note 1)
- Supply Voltage Variation (@ ±5% change):  
Frequency <20MHz: ±0.1ppm typ  
Frequency 20MHz to <35MHz: ±0.3ppm typ  
Frequency 35MHz to 52MHz: ±0.5ppm typ
- Load Variation (@ ±5pF change):  
Frequency <20MHz: ±0.2ppm typ  
Frequency 20MHz to <35MHz: ±0.3ppm typ  
Frequency 35MHz to 52MHz: ±0.5ppm typ
- Note 1 Ageing:  
Frequency ≤20MHz: ±1ppm max in 1st year  
Frequency ≤20MHz: ±3ppm max for 10 years (including the 1st year)  
Frequency >20MHz: ±2ppm max in 1st year  
Frequency >20MHz: ±5ppm max for 10 years (including the 1st year)

**Electrical Parameters**

- Supply Voltage 3.3V ±10%
- Supply Current (typical):  
HCMOS:  $1 + \text{Frequency(MHz)} * \text{Supply(V)} * \{\text{Load(pF)} + 15\} * 1E-3\text{mA}$   
i.e @ 20MHz, 3.3V, 15pF ≈ 3mA  
Calculation:  $1 + (20 \times 3.3 \times (15 + 15) \times 0.001) = 2.98\text{mA}$
- Supply Voltage Tolerance: Parts will operate correctly with ±10% supply voltage variation but supply coefficient is measured with ±5% variation
- Frequency Adjustment - option B  
No frequency adjustment  
Initial calibration: ≤ ±1.0ppm

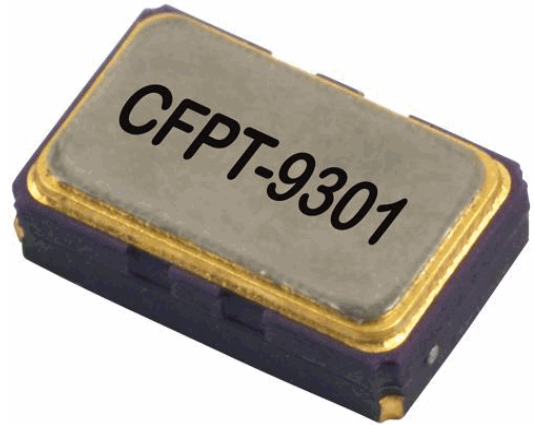

**Outline (mm)**

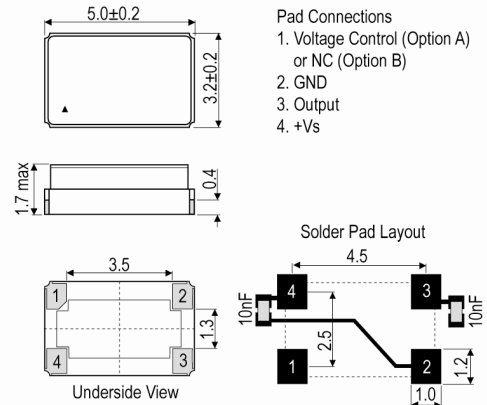

**Test Circuit**

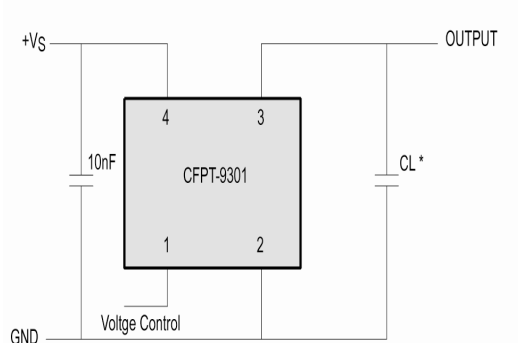

\* Load 15pF (HCMOS), inclusive of probe and jig capacitance

**Sales Office Contact Details:**

UK: +44 (0)1460 270200  
Germany: 0800 1808 443

France: 0800 901 383  
USA: +1.760.318.2824

Email: [info@iqdfrequencyproducts.com](mailto:info@iqdfrequencyproducts.com)  
Web: [www.iqdfrequencyproducts.com](http://www.iqdfrequencyproducts.com)



**Customer Part:**

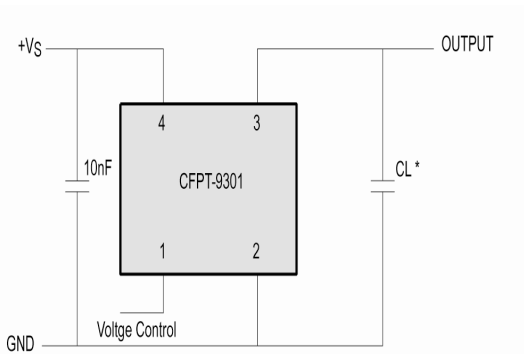

\* Load 15pF (HCMOS), inclusive of probe and jig capacitance

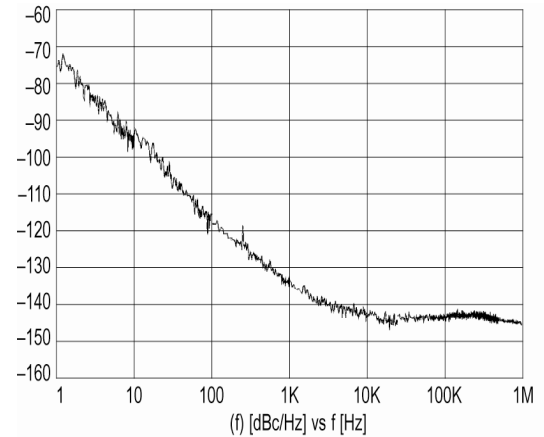

**Chipset Approval Table**

Ref No.	Frequency	Chipset Type	IC Supplier
E4190LF	12.8MHz	ACS1790T, ACS9510, ACS9520T, ACS9522T, ACS9550, ACS9593T, ACS8522BT, ACS8509, ACS8510, ACS8514, ACS8515, ACS8520, ACS8520A, ACS8522	Semtech
E4191LF	12.8MHz	ACS1790T, ACS9510, ACS9520T, ACS9522T, ACS9550, ACS9593T, ACS8522BT, ACS8509, ACS8510, ACS8514, ACS8515, ACS8520, ACS8520A, ACS8522	Semtech
E4437LF	12.8MHz	ACS1790T, ACS9510, ACS9520T, ACS9522T, ACS9550, ACS9593T, ACS8522BT, ACS8509, ACS8510, ACS8514, ACS8515, ACS8520, ACS8520A, ACS8522	Semtech
E4438LF	20MHz	ZL30152, ZL30155, ZL30157, ZL30159, ZL30160, ZL30165	Microsemi
E4439LF	20MHz	ZL30152, ZL30155, ZL30157, ZL30159, ZL30160, ZL30165	Microsemi
E4441LF	20MHz	ZL30152, ZL30155, ZL30157, ZL30159, ZL30160, ZL30165	Microsemi
E4698LF	12.8MHz	ACS1790T, ACS9510, ACS9520T, ACS9522T, ACS9550, ACS9593T, ACS8522BT, ACS8509, ACS8510, ACS8514, ACS8515, ACS8520, ACS8520A, ACS8522	Semtech

**Sales Office Contact Details:**

UK: +44 (0)1460 270200  
Germany: 0800 1808 443

France: 0800 901 383  
USA: +1.760.318.2824

Email: [info@iqdfrequencyproducts.com](mailto:info@iqdfrequencyproducts.com)  
Web: [www.iqdfrequencyproducts.com](http://www.iqdfrequencyproducts.com)