

General Description

The AAT3176A is a high output current, high efficiency, low noise, low profile charge pump converter IC, ideal for multi-function LED photo-flash applications where solution cost, size, and efficiency are critical. The charge pump is capable of delivering up to 500mA of output current and can be easily programmed in 16 steps with a single GPIO output through Skyworks' S²Cwire™ (Simple Serial Control) interface. This allows smooth transitions and flexible adjustment of brightness in flash or other lighting modes. Operating at a fast 1MHz switching frequency, the dual-mode (1x/2x) operation of the internal charge pump offers excellent power efficiency for both flash and movie modes and combined with a low external parts count (one 1μF flying capacitors and small bypass capacitors at VIN and OUT), the AAT3176A is ideally suited for small, battery-powered applications.

The maximum current for both Flash and Movie mode is set by two independent external resistors. The MODE pin is adopted to select the LED current between Movie (Torch) and Flash mode.

The AAT3176A has a thermal management system to protect the device in the event of short-circuit, open-circuit, and over-temperature condition. Built-in soft-start circuitry prevents excessive in-rush current during start-up. The shutdown feature disconnects the load from V_{IN} and reduces quiescent current to less than 1.0μA.

The AAT3176A is available in the 2.2 x 2.2mm Pb-free 10-pin TDFN package.

Features

- 2.7V to 5.5V Supply Voltage Range
- Up to 500mA Output Drive Capability at 3.6V V_{IN}
- Flexible Brightness Control
 - 16 Step Output Current by S²Cwire
- Separate External Resistors to Set Maximum Flash and Movie-Mode Current
- Dual Mode 1x/2x Charge Pump
- < 1.0μA in Shutdown
- Small Application Circuit
- Automatic Soft-Start Limits Inrush Current
- Open- and Short-Circuit Protection
- Thermal Shutdown Protection
- -40 to +85°C Temperature Range
- 10-pin TDFN2.2x2.2 Package

Applications

- Digital Still Cameras (DSC)
- LED Photo Flash/Torch
- Mobile Handsets
- PDAs and Notebook PCs

Typical Application

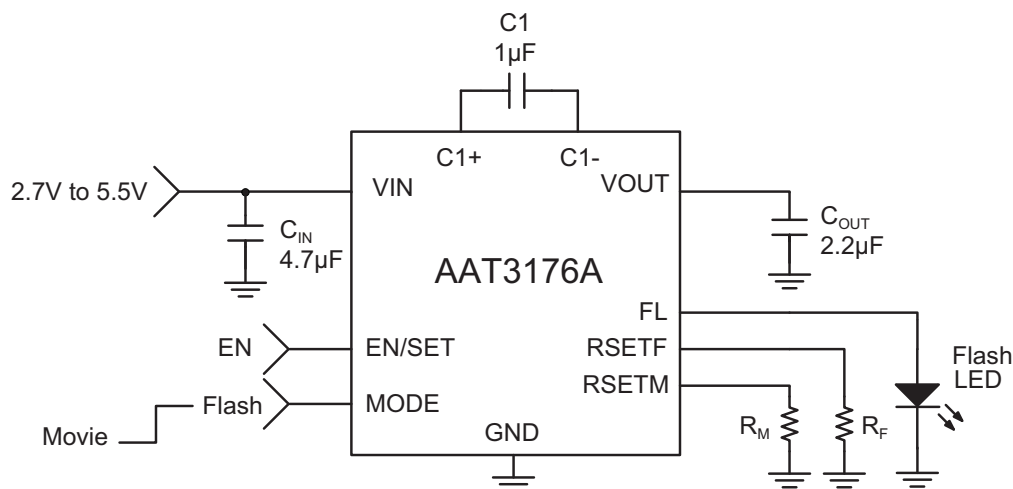

AAT3176A**500mA LED Flash Driver****Pin Descriptions**

Pin #	Symbol	Description
1	C1+	Flying capacitor C1 positive terminal. Connect a 1.0 μ F capacitor between C1+ and C1-.
2	VOUT	Charge-pump output. Requires 2.2 μ F bypass capacitor to ground.
3	FL	Output current source. Connect the flash LED anode to this pin.
4	RSETF	Connect a resistor to GND to set maximum FLASH output current.
5	RSETM	Connect a resistor to GND to set maximum MOVIE-MODE output current.
6	MODE	Selects between Flash and Movie Mode: When MODE is HIGH, it is in Flash Mode with RSETF for maximum current. When MODE is LOW, it is in Movie Mode with RSETM for maximum current .
7	EN/SET	Charge Pump enable / set input control pin. When in the low state, the AAT3176A is shut down, and consumes less than 1 μ A. When connected logic high level, the AAT3176A is active. This pin must be connected.
8	GND	Ground connection and flash LED cathode.
9	C1-	Flying capacitor C1 negative terminal.
10	VIN	Input power supply pin. Requires 4.7 μ F bypass capacitor to ground.
EP		Exposed pad. Connect directly to ground beneath the package.

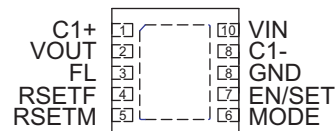
Pin Configuration**TDFN2.2x2.2-10
(Top View)**

DATA SHEET

AAT3176A

500mA LED Flash Driver

Absolute Maximum Ratings¹

$T_A = 25^\circ\text{C}$ unless otherwise noted.

Symbol	Description	Value	Units
V_{IN}	Input Voltage	-0.3 to 6.0	V
V_{EN}	EN to GND Voltage	-0.3 to 6.0	V
$V_{EN(MAX)}$	Maximum EN to Input Voltage	$V_{IN} + 0.3$	V
I_{OUT}	Maximum DC Output Current ²	150	mA
	Maximum Peak Output Current (lasting 1 second)	550	mA
T_J	Maximum Junction Operating Temperature	-40 to 150	°C
T_S	Storage Temperature Range	-65 to 150	
T_{LEAD}	Maximum Soldering Temperature (at leads, 10 sec)	300	

Thermal Information³

Symbol	Description	Value	Units
Θ_{JA}	Thermal Resistance ⁴	71.4	°C/W
P_D	Maximum Power Dissipation ($T_A = 25^\circ\text{C}$)	1.4	W

1. Stresses above those listed in Absolute Maximum Ratings may cause permanent damage to the device. Functional operation at conditions other than the operating conditions specified is not implied. Only one Absolute Maximum Rating should be applied at any one time.

2. Based on long-term current density limitation.

3. Mounted on an FR4 board.

4. Derate 71.4mW/°C above 25°C.

DATA SHEET

AAT3176A

500mA LED Flash Driver

Electrical Characteristics¹

$V_{IN} = 3.6V$; $C_{IN} = 4.7\mu F$; $C_{OUT} = 2.2\mu F$; $C_{FLY} = 1\mu F$; $R_{SETF} = 21k\Omega$; $R_{SETM} = 105k\Omega$; $T_A = -40^\circ C$ to $85^\circ C$, unless otherwise noted. Typical values are $T_A = 25^\circ C$.

Symbol	Description	Conditions	Min	Typ	Max	Units
Power Supply						
V_{IN}	Input Voltage Range		2.7		5.5	V
$V_{OUT(max)}$	Maximum Output Voltage			5.5		V
I_{INQ}	Input Operating Current	EN/SET = IN, 1x mode, $I_f = 100mA$		0.5		mA
		EN/SET = IN, 2x mode, $I_f = 100mA$		3.0		
$I_{SHDN(MAX)}$	VIN Pin Shutdown Current	EN = GND			1.0	μA
I_{IN_Short}	Input Current at Short Circuit	$V_f = 0V$		25		mA
I_{DM}	Movie Output Current	$R_{SETM} = 105k\Omega$		100		mA
I_{DF}	Flash Output Current	$R_{SETF} = 21k\Omega$, $T_A = 25^\circ C$	450	500	550	mA
		$R_{SETF} = 21k\Omega$, $V_{IN} = 3.0V$		350		mA
$I_{OUT(MAX)}$	Maximum Output Current	$V_f = 3.6V$	500			mA
I_{LED}/I_{SET}	LED Current Ratio			8652		
F_{CLK}	Charge Pump Clock Frequency in 2X Mode		0.5	1	1.5	MHz
T_{SS}	Soft-Start Time			100		μs
EN/SET, MODE						
V_{RSET}	R_{SETF} and R_{SETM} Pin Voltage			1.22		V
$V_{EN/MODE(L)}$	EN/MODE Threshold Low				0.4	V
$V_{EN/MODE(H)}$	EN/MODE Threshold High		1.4			V
I_{LEAK}	EN/SET, MODE input leakage		-1		1	μA
S²C Control						
$T_{EN/SET LO}$	EN/SET Low Time		0.3		75	μs
$T_{EN/SET HI(MIN)}$	Minimum EN/SET High Time			50		ns
$T_{EN/SET HI(MAX)}$	Maximum EN/SET High Time				75	μs
T_{OFF}	EN/SET Off Timeout				500	μs
T_{LAT}	EN/SET Latch Timeout				500	μs
Thermal Protection						
T_{SD}	Thermal Shutdown Threshold			140		$^\circ C$
T_{HYS}	Thermal Shutdown Hysteresis			15		

1. The AAT3176A is guaranteed to meet performance specifications over the $-40^\circ C$ to $+85^\circ C$ operating temperature range and is assured by design, characterization, and correlation with statistical process controls.

AAT3176A

500mA LED Flash Driver

Typical Characteristics

Quiescent Current vs. Input Voltage
($V_F = 3.6V$; $R_{SET} = 105k\Omega$)

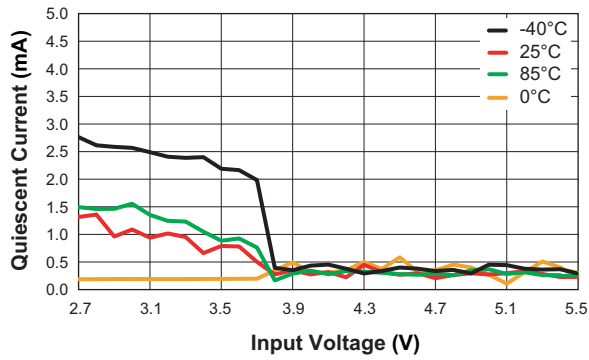

Shutdown Current vs. Input Voltage
($V_F = 3.6V$; $EN = 0V$)

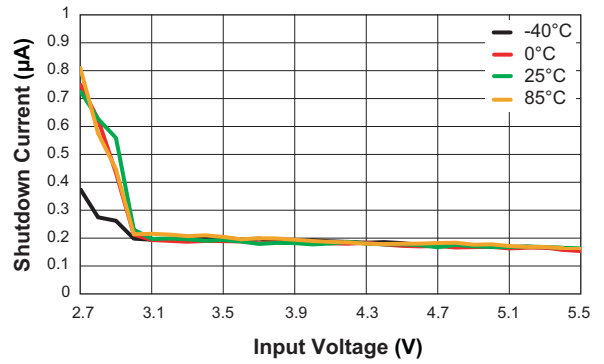

Efficiency vs. Input Voltage
($R_{SET} = 105k\Omega$; $I_F = 100mA$)

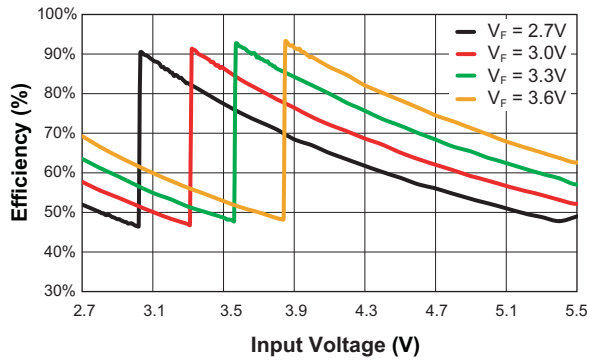

Efficiency vs. Input Voltage
($R_{SETF} = 52.3k\Omega$; $I_F = 200mA$)

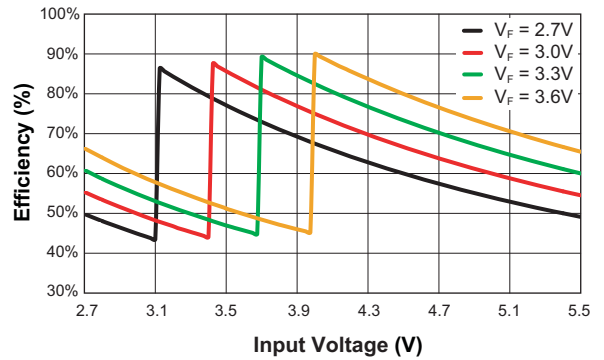

Efficiency vs. Input Voltage
($R_{SETF} = 35.7k\Omega$; $I_F = 300mA$)

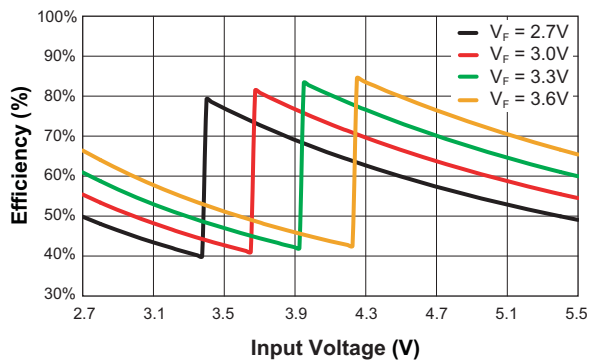

Efficiency vs. Input Voltage
($R_{SETF} = 21k\Omega$; $I_F = 500mA$)

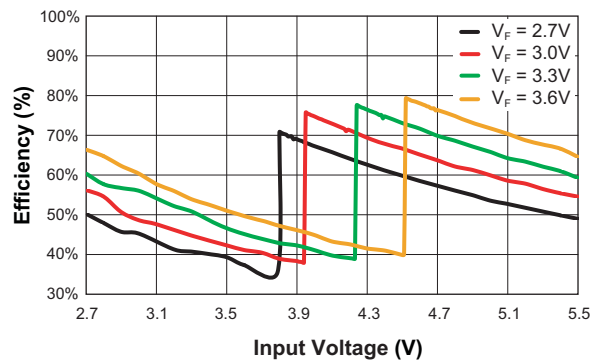

AAT3176A

500mA LED Flash Driver

Typical Characteristics

LED Current vs. Input Voltage
($R_{SET} = 105k\Omega$; $I_F = 100mA$)

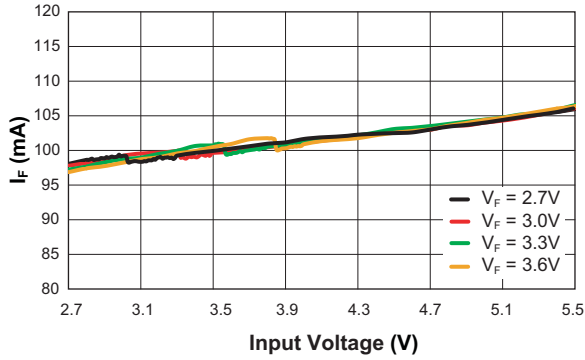

LED Current vs. Input Voltage
($R_{SET} = 52.3k\Omega$; $I_F = 200mA$)

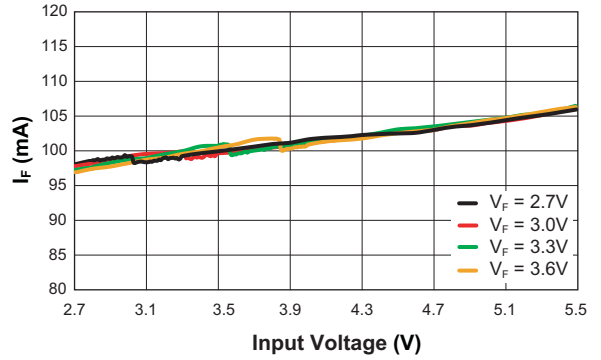

LED Current vs. Input Voltage
($R_{SET} = 35.7k\Omega$; $I_F = 300mA$)

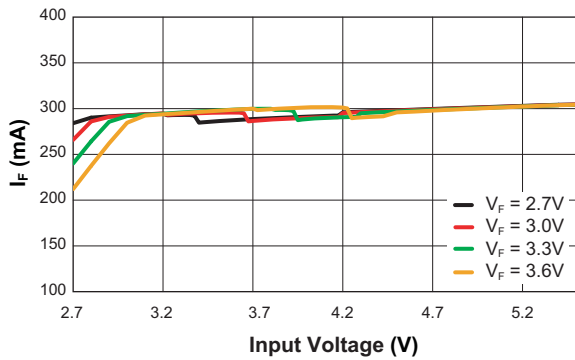

LED Current vs. Input Voltage
($R_{SET} = 21k\Omega$; $I_F = 500mA$)

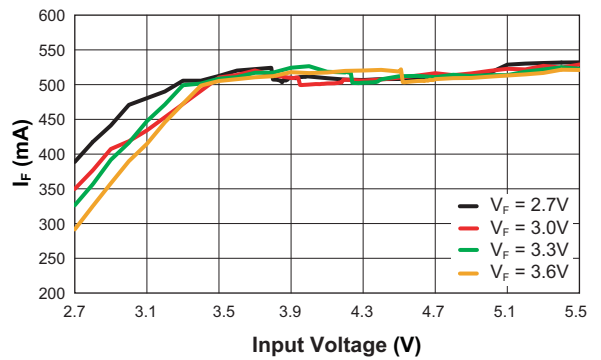

Maximum Output Current vs. Input Voltage
($R_{SETM} = 105k\Omega$; $V_F = 3.6V$)

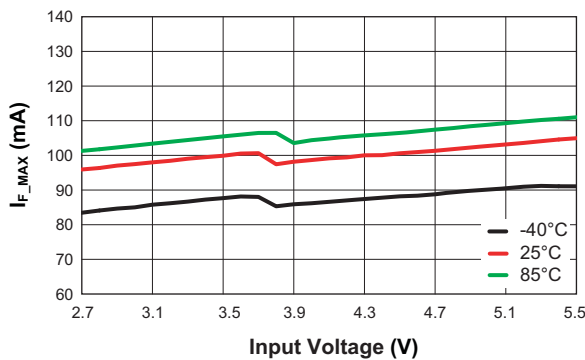

Maximum Output Current vs. Input Voltage
($R_{SETF} = 21k\Omega$; $V_F = 3.6V$)

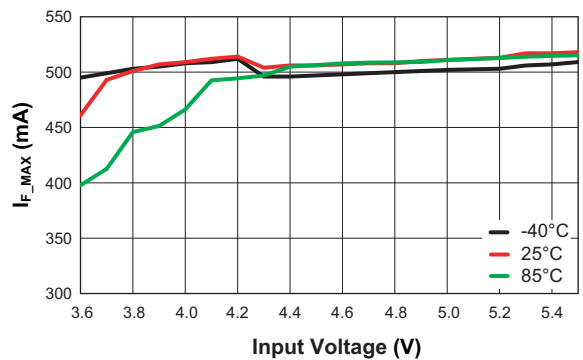

Typical Characteristics

EN/MODE Threshold High vs. Temperature

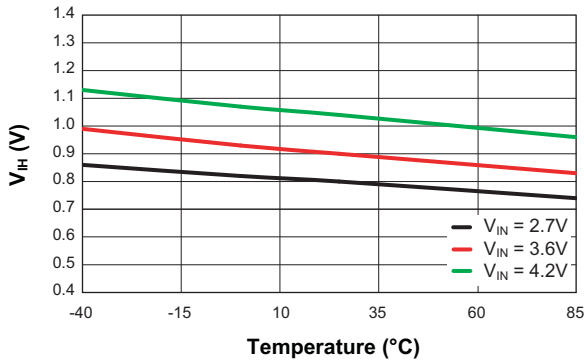

EN/MODE Threshold Low vs. Temperature

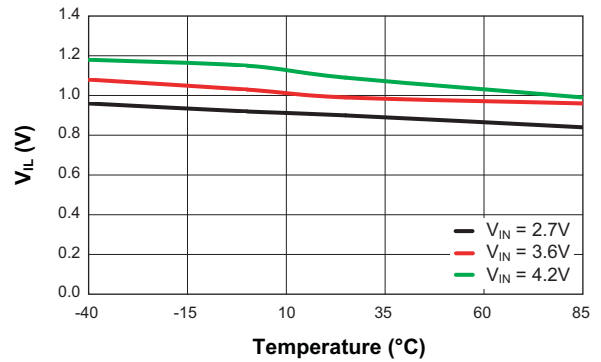

LED Current vs. R_{SET}

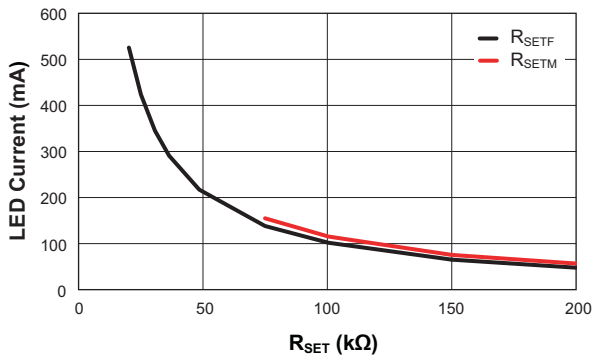

EN Leakage Current vs. Input Voltage
(V_F = 3.6V; V_{EN} = 5.5V; R_{SET} = 21kΩ)

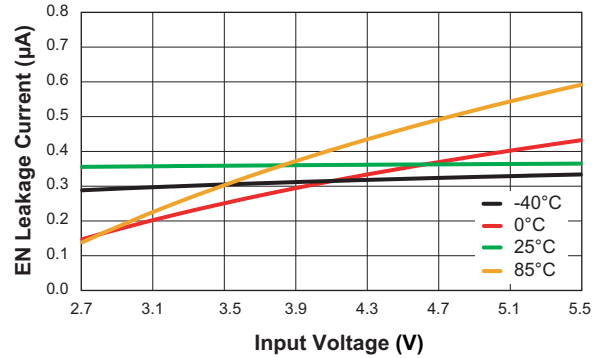

Oscillator Frequency vs. Input Voltage

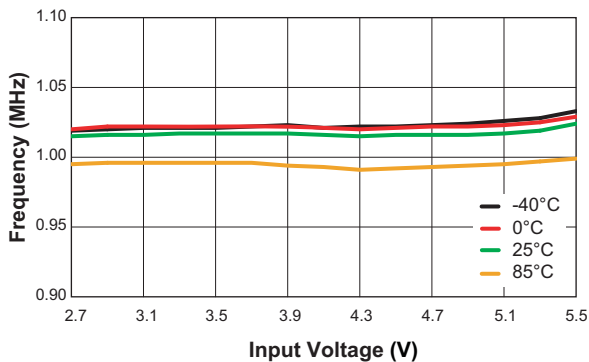

Typical Characteristics

LED Current Transient by MODE Change

($V_{IN} = 5.0V$; $V_F = 3.6V$; $R_{SETF} = 20k\Omega$; $R_{SETM} = 105k\Omega$)

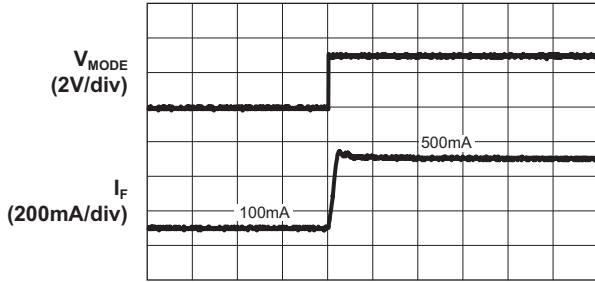

Time (40µs/div)

LED Current Transient by MODE Change

($V_{IN} = 5.0V$; $V_F = 3.6V$; $R_{SETF} = 20k\Omega$; $R_{SETM} = 105k\Omega$)

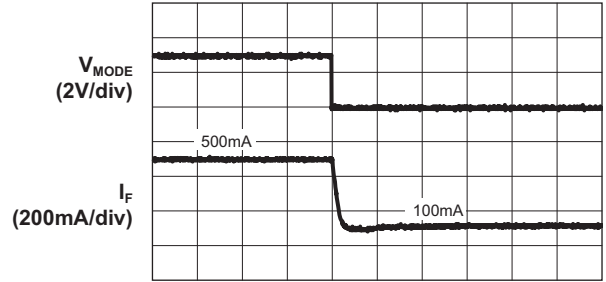

Time (40µs/div)

LED Current Transient by EN/SET

($V_{IN} = 5.0V$; $V_F = 3.6V$; $R_{SETF} = 20k\Omega$; $V_{MODE} = 3.6V$)

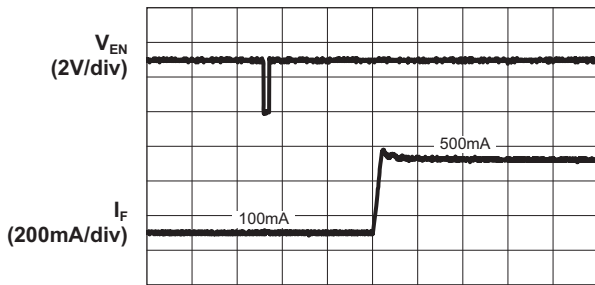

Time (40µs/div)

LED Current Transient by EN/SET

($V_{IN} = 5.0V$; $V_F = 3.6V$; $R_{SETF} = 20k\Omega$; $V_{MODE} = 3.6V$)

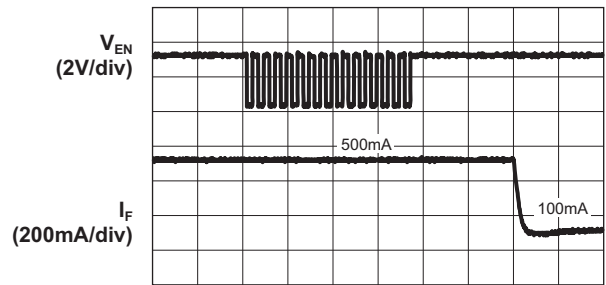

Time (40µs/div)

Functional Block Diagram

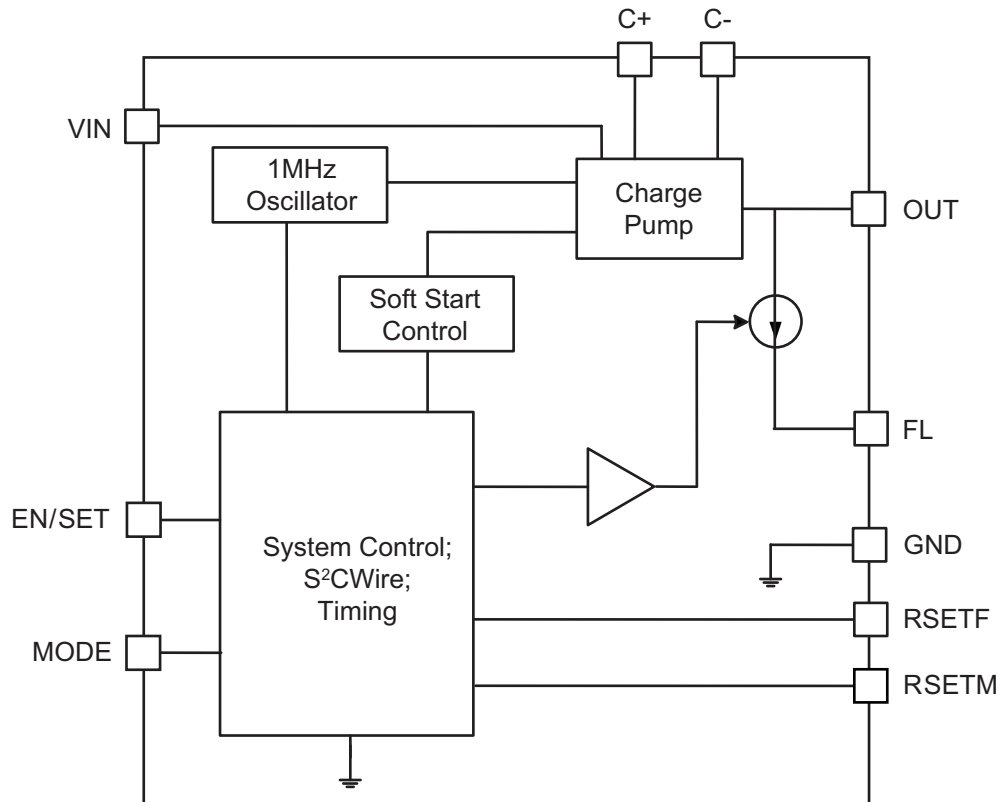

Functional Description

The AAT3176A is a high efficiency, low noise, 1x/2x regulating charge pump device intended for photo flash LED applications. The AAT3176A requires only 3 external components: one 1.0 μ F ceramic capacitor for the charge pump flying capacitor, one 4.7 μ F ceramic capacitor for C_{IN} , and one 2.2 μ F to 4.7 μ F ceramic capacitor for C_{OUT} filtering.

The charge pump is designed to deliver up to 500mA load current at $V_{IN} = 3.6V$. The dual mode charge pump section contains soft start circuitry to prohibit an excessive inrush current during start up. System efficiency is maximized with a 1x/2x mode, dual mode charge-pump topology. The internal clock oscillator frequency of 1MHz allows the use of small external components.

Depending upon the variation of load current (at different modes), input voltage, and LED forward voltage, the charge pump will operate in 1x or 2x mode to generate the output voltage required to power the load for the

required current. This results in significant power savings over pure voltage doubling architectures, especially when the LEDs are operated at lower current levels in movie, viewing, or flash modes.

The AAT3176A also includes open- and short-circuit protection to deal with fault situations. When the flash LED is not connected (an open fault occurs), the V_{OUT} will be limited to 6V; When a flash LED short fault occurs, the total input current is limited to typical 25mA.

S²Cwire Serial Interface

The AAT3176A utilizes Skyworks' single-wire S²Cwire interface to enable/disable the charge pump and adjust the output current level to one of sixteen different current levels. Each DATA defines the output current as a percentage of the maximum current set by the resistor at the R_{SET} pin, as detailed in Table 1.

The S²Cwire interface records rising edges of the EN/SET pin and decodes them into 16 individual current level

settings, with DATA 1 reserved for maximum current. Once EN/SET has been held in the logic high state for time T_{LAT} , the programmed current is set at the current source outputs. For subsequent current level programming, the number of rising edges corresponding to the desired DATA must be entered on the EN/SET pin. Figure 1 shows the S²Cwire™ interface timing.

When EN/SET is held low for an amount of time greater than T_{OFF} , the AAT3176A enters shutdown mode and draws less than 1µA from VIN. Data and Address registers are reset to 0 during shutdown.

DATA	Output Current (% of I_{MAX})
1	100.0%
2	89.1%
3	79.4%
4	70.8%
5	63.1%
6	56.2%
7	50.1%
8	44.7%
9	39.8%
10	35.5%
11	31.6%
12	28.2%
13	25.1%
14	22.4%
15	20.0%
16	7.5%

Table 1: Output Current at Different S²Cwire DATA.¹

Application Information

Flash and Movie Mode LED Current Setting

The AAT3176A has two independent LED current setting pins for LED current in flash and movie mode: R_{SETF} and R_{SETM} . The MODE pin is designed to select which current set flows through the LED. When MODE is high, the current set by R_{SETF} is the maximum LED current; when MODE is low, the maximum current is set by R_{SETM} . The calculation method of the LED current set resistor value R_{SET} is the same for either mode and can be calculated using the following formula:

$$R_{SETF} = R_{SETM} = \frac{1.22}{I_{LED}} \cdot 8652$$

Table 2 shows some examples of 1% standard metal film resistor values for different maximum LED currents (DATA = 1) in movie and flash mode.

R_{SETM} (kΩ)	Maximum LED Current (mA)	R_{SETF} (kΩ)	Maximum LED Current (mA)
210.0	50	105.0	100
174.0	60	69.8	150
150.0	70	52.3	200
130.0	80	42.2	250
118.0	90	35.7	300
105.0	100	30.1	350
		26.1	400
		23.7	450
		21.0	500

Table 2: Example of Maximum LED Current Set by R_{SETM} and R_{SETF} .²

S²Cwire Serial Interface Timing

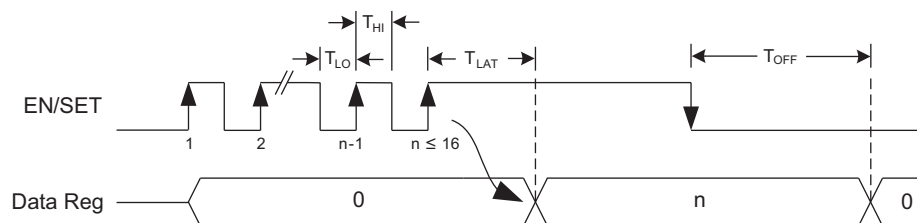

Figure 1: S²Cwire Interface Timing.

1. The flash LED accuracy is compromised at high DATA settings.
 2. The flash LED accuracy is compromised at high resistor values.

AAT3176A

500mA LED Flash Driver

LED current can be set to levels lower than maximum via S²C DATA transferred through the EN/SET pin, corresponding to percentage of the maximum setting value. In movie mode, continuous high level of EN/SET lights the LED light continuously at the programmed current. In flash mode, EN/SET high level duration controls flash time; the maximum flash time is 1 second for 500mA LED current limited by the thermal characteristics of the package. Figure 2 shows the operating waveform of the AAT3176A driving an LED for 500ms flash time in flash mode with 500mA LED current at 3.6V V_{IN} (2x mode).

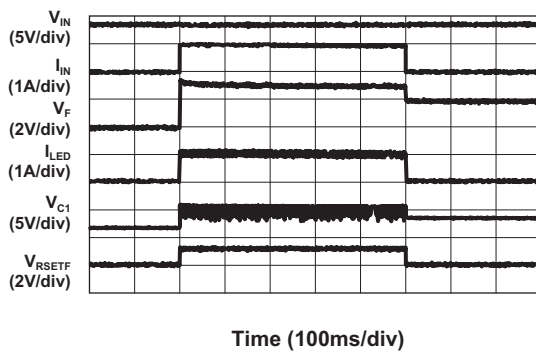

Figure 2: AAT3176A Operating Waveform at 500mA LED Current with 500ms Flash Time (R_{SETF} = 21kΩ).

Thermal Considerations

The AAT3176A is designed to deliver continuous LED current in movie mode. The limiting characteristic for maximum safe operating output LED current is package power dissipation. In order to obtain high operating currents, careful device layout and circuit operating conditions must be taken into account. The following discussions assume that the AAT3176A is mounted on a printed circuit board utilizing the minimum recommended footprint as stated in the "Printed Circuit Board Layout Recommendations" section of this datasheet.

At any given ambient temperature (T_A), the maximum package power dissipation can be determined by the following equation:

$$P_{D(MAX)} = \frac{(T_{J(MAX)} - T_A)}{\theta_{JA}}$$

The AAT3176A is available in the TDFN2.2x2.2-10 package, which has 71.4°C/W of thermal resistance (θ_{JA}). With 125°C T_{J(MAX)}, its P_{D(MAX)} is 1.4W. The maximum

power dissipation occurs when the mode transfers from 1x to 2x. If the die temperature rises above the thermal limit of 140°C, the internal thermal protection circuit activates to shut down the charge pump and recovers when the die temperature drops below 125°C.

To avoid entering thermal protection in flash mode at the 500mA high flash LED current setting, the flash time should not exceed 1 second at 25°C ambient temperature. Longer flash time causes the junction temperature to increase quickly, causing thermal shutdown. The LED current recovers automatically when the junction temperature decreases.

In movie mode, maximum continuous current value is not limited by the package thermal resistance but by the integrated metal current density. The maximum value should not exceed 150mA.

Charge Pump Efficiency

The power conversion efficiency of the AAT3176A depends on the charge pump mode. By definition, device efficiency is expressed as the output power delivered to the LED divided by the total input power consumed.

$$\eta = \frac{P_{OUT}}{P_{IN}}$$

When the input voltage is sufficiently greater than the LED forward voltage, the device optimizes efficiency by operating in 1x mode. In 1x mode, the device is working as a bypass switch and passing the input supply directly to the output. Due to the very low 1x mode quiescent current, the input current nearly equals the current delivered to the LED. Further, the low-impedance bypass switch introduces negligible voltage drop from input to output. The power conversion efficiency can be approximated by:

$$\eta = \frac{V_F \cdot I_{LED}}{V_{IN} \cdot I_{IN}} \approx \frac{V_F}{V_{IN}}$$

The AAT3176A maintains optimized performance and efficiency by detecting. When the input voltage is not sufficient to sustain LED current, the device automatically switches to 2x mode. For ideal conversion, the 2x mode efficiency is given by:

$$\eta = \frac{V_F \cdot I_{LED}}{V_{IN} \cdot I_{IN}} = \frac{V_F \cdot I_{LED}}{V_{IN} \cdot 2 \cdot I_{LED}} \approx \frac{V_F}{2 \cdot V_{IN}}$$

AAT3176A

500mA LED Flash Driver

LED Selection

A good LED lighting application circuit not only determined by the LED driver but also the LED selected. A higher luminous efficacy LED emits a higher amount of luminous flux (lumens) for a given power. Most LED manufacturers' datasheets provide the luminous efficacy by the luminous flux curve (LED forward current vs luminous flux). From the luminous flux curve, increasing the LED forward current may increase the LED light; increased LED forward current also increases LED forward voltage with higher rating.

The AAT3176A is designed to drive high-intensity white LEDs. It is particularly suitable for LEDs with an operating forward voltage V_F in the range of 4.2V to 1.5V. Low forward voltage (V_F) flash LED may make the 1x/2x mode automatically transfer voltage point lower and get higher efficiency at the mode transfer input voltage.

Capacitor Selection

Careful selection of the three external capacitors C_{IN} , C_1 , and C_{OUT} is important because they will affect turn-on time, output ripple and transient performance. Optimum performance is obtained when low ESR ceramic capacitors are used; in general, low ESR may be defined as less than 100m Ω . A capacitor value of 1 μ F for all three capacitors is a good starting point when choosing capacitors; a 2.2 μ F to 4.7 μ F value is suitable for input and output capacitance.

Ceramic composition capacitors are highly recommended over all other types of capacitors for use with the AAT3176A. Ceramic capacitors offer many advantages over their tantalum and aluminum electrolytic counterparts. A ceramic capacitor typically has very low ESR, is lowest cost, has a smaller PCB footprint and is non-polarized. Low ESR ceramic capacitors help to maximize charge pump transient response. Since ceramic capacitors are non-polarized, they are not prone to incorrect connection damage.

Equivalent Series Resistance (ESR)

ESR is an important characteristic to consider when selecting a capacitor. ESR is resistance internal to a capacitor, which is caused by the leads, internal connections, size or area, material composition, and ambient temperature. Capacitor ESR is typically measured in milliohms for ceramic capacitors and can range to more than several ohms for tantalum or aluminum electrolytic capacitors.

Printed Circuit Board Layout Recommendations

When designing a PCB for the AAT3176A, the key requirements are:

1. Place the flying capacitor C_p as close to the chip as possible; otherwise 2x mode performance will be compromised.
2. Place input and output decoupling capacitors as close to the chip as possible to reduce switching noise and output ripple.
3. Connect the exposed pad to the GND plane to achieve the best power dissipation.

AAT3176A**500mA LED Flash Driver**

Component	Part Number	Description	Manufacturer
U1	AAT3176AIDH	500mA LED Flash Driver with Flash and Movie Mode	Skyworks
U2	PIC12F675	8-Pin Flash-Based 8-Bit CMOS Microcontrollers	Microchip
C1	GRM188R71C104K	Cap Ceramic 0.1 μ F 0603 X7R 16V 10%	Murata
CIN	GRM188R60J475K	Cap Ceramic 4.7 μ F 0603 X5R 6.3V 10%	
COU1	GRM188R61A225K	Cap Ceramic 2.2 μ F 0603 X5R 10V 10%	
CP	GRM188R71C105K	Cap Ceramic 1 μ F 0603 X7R 16V 10%	
CYCLE, UP, DOWN	6*6*5	12V 50mA Pushbutton	E-LT
D1	FCW401Z4	Max 300mA Forward Current, Max 1500mA/300ms Peak Forward Current	Seoul
LED1	0805KGCT	Green LED 0805	HB
LED2	0805KRCT	Red LED 0805	
R1 - R5	RC0603FR-071KL	Res 1K Ω 1/10W 1% 0603 SMD	Yageo
R6	RC0603FR-0720KL	Res 20K Ω 1/10W 1% 0603 SMD	
R7	RC0603FR-070RL	Res 0 Ω 1/10W 1% 0603 SMD	
RSETF	RC0603FR-0721KL	Res 21K Ω 1/10W 1% 0603 SMD	
RSETM	RC0603FR-07105KL	Res 105K Ω 1/10W 1% 0603 SMD	

Table 3: AAT3176A Evaluation Board Bill of Materials (BOM).

DATA SHEET

AAT3176A

500mA LED Flash Driver

Ordering Information

Package	Part Marking ¹	Part Number (Tape and Reel) ²
TDFN2.2x2.2-10	J5XYY	AAT3176AIDH-T1



Skyworks Green™ products are compliant with all applicable legislation and are halogen-free. For additional information, refer to *Skyworks Definition of Green™*, document number SQ04-0074.

Package Information

TDFN2.2x2.2-10

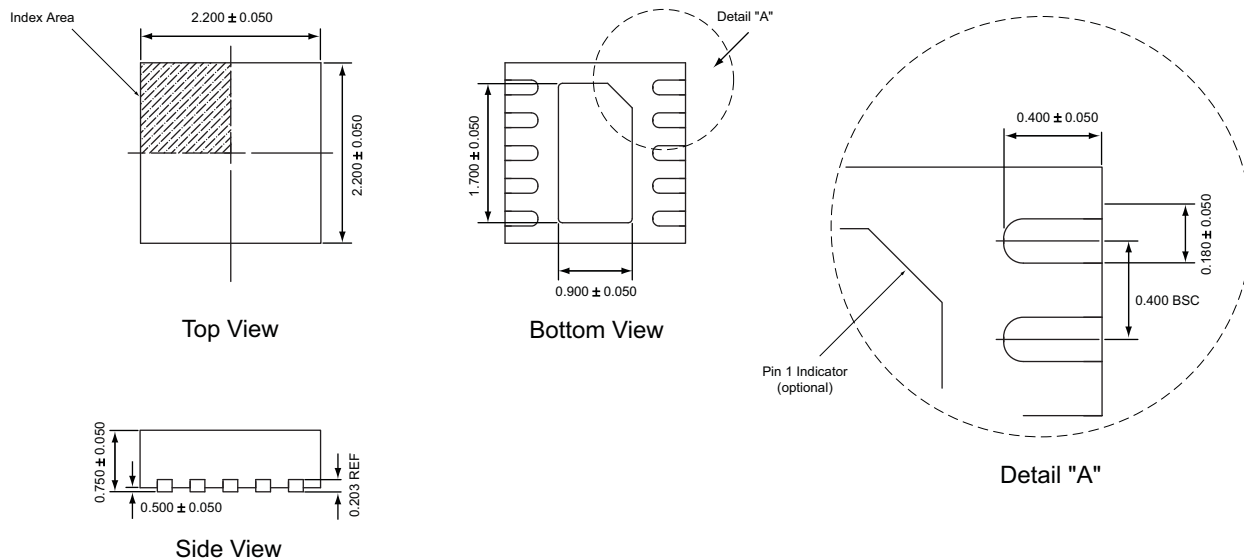

All dimensions in millimeters.

1. XYY = assembly and date code.
2. Sample stock is generally held on part numbers listed in **BOLD**.
3. The leadless package family, which includes QFN, TQFN, DFN, TDFN and STDFN, has exposed copper (unplated) at the end of the lead terminals due to the manufacturing process. A solder fillet at the exposed copper edge cannot be guaranteed and is not required to ensure a proper bottom solder connection.

Copyright © 2012 Skyworks Solutions, Inc. All Rights Reserved.

Information in this document is provided in connection with Skyworks Solutions, Inc. ("Skyworks") products or services. These materials, including the information contained herein, are provided by Skyworks as a service to its customers and may be used for informational purposes only by the customer. Skyworks assumes no responsibility for errors or omissions in these materials or the information contained herein. Skyworks may change its documentation, products, services, specifications or product descriptions at any time, without notice. Skyworks makes no commitment to update the materials or information and shall have no responsibility whatsoever for conflicts, incompatibilities, or other difficulties arising from any future changes.

No license, whether express, implied, by estoppel or otherwise, is granted to any intellectual property rights by this document. Skyworks assumes no liability for any materials, products or information provided hereunder, including the sale, distribution, reproduction or use of Skyworks products, information or materials, except as may be provided in Skyworks Terms and Conditions of Sale.

THE MATERIALS, PRODUCTS AND INFORMATION ARE PROVIDED "AS IS" WITHOUT WARRANTY OF ANY KIND, WHETHER EXPRESS, IMPLIED, STATUTORY, OR OTHERWISE, INCLUDING FITNESS FOR A PARTICULAR PURPOSE OR USE, MERCHANTABILITY, PERFORMANCE, QUALITY OR NON-INFRINGEMENT OF ANY INTELLECTUAL PROPERTY RIGHT; ALL SUCH WARRANTIES ARE HEREBY EXPRESSLY DISCLAIMED. SKYWORKS DOES NOT WARRANT THE ACCURACY OR COMPLETENESS OF THE INFORMATION, TEXT, GRAPHICS OR OTHER ITEMS CONTAINED WITHIN THESE MATERIALS. SKYWORKS SHALL NOT BE LIABLE FOR ANY DAMAGES, INCLUDING BUT NOT LIMITED TO ANY SPECIAL, INDIRECT, INCIDENTAL, STATUTORY, OR CONSEQUENTIAL DAMAGES, INCLUDING WITHOUT LIMITATION, LOST REVENUES OR LOST PROFITS THAT MAY RESULT FROM THE USE OF THE MATERIALS OR INFORMATION, WHETHER OR NOT THE RECIPIENT OF MATERIALS HAS BEEN ADVISED OF THE POSSIBILITY OF SUCH DAMAGE.

Skyworks products are not intended for use in medical, lifesaving or life-sustaining applications, or other equipment in which the failure of the Skyworks products could lead to personal injury, death, physical or environmental damage. Skyworks customers using or selling Skyworks products for use in such applications do so at their own risk and agree to fully indemnify Skyworks for any damages resulting from such improper use or sale.

Customers are responsible for their products and applications using Skyworks products, which may deviate from published specifications as a result of design defects, errors, or operation of products outside of published parameters or design specifications. Customers should include design and operating safeguards to minimize these and other risks. Skyworks assumes no liability for applications assistance, customer product design, or damage to any equipment resulting from the use of Skyworks products outside of stated published specifications or parameters.

Skyworks, the Skyworks symbol, and "Breakthrough Simplicity" are trademarks or registered trademarks of Skyworks Solutions, Inc., in the United States and other countries. Third-party brands and names are for identification purposes only, and are the property of their respective owners. Additional information, including relevant terms and conditions, posted at www.skyworksinc.com, are incorporated by reference.