

# 3M™ Wiremount Socket

.100" × .200" for .050" Pitch Cable

3000 Series

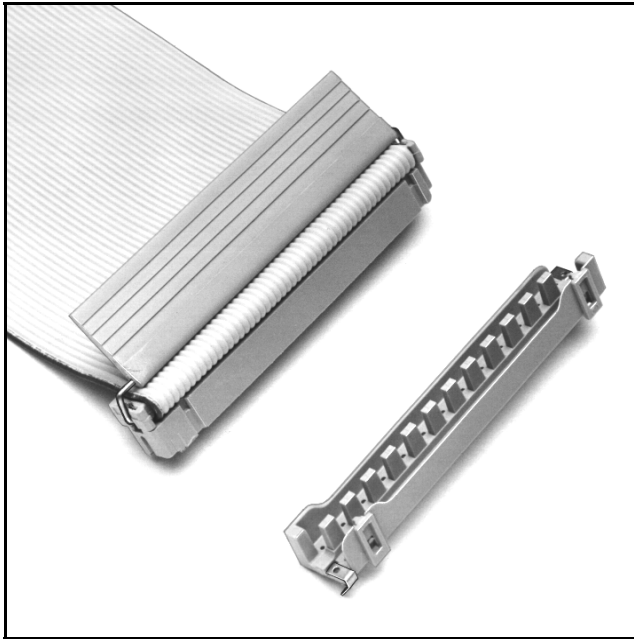

- Available in 20, 26, 34, 40 and 50 position
- Keying pinless shroud provides polarization
- Keying plug 3497-1 allows keying without pin loss
- Positive locking metal “J” clip provides high cover retention
- Optional strain relief and pull tab
- Retainer clips add up to 20 pounds pin retention for the pin shroud
- Pin shroud corner stops ensure proper pin height for mating socket
- Optional polarizing key 3518 provides polarization of socket connectors
- RoHS\* compliant

Date Modified: January 25, 2011

TS-0097-B  
Sheet 1 of 4

## Physical

### Insulation

Material: Glass Filled Polyester (PBT)

Flammability: UL 94V-0

Color: Gray

### Contact

Material: Copper Alloy

J-Clip Material: Stainless Steel

### Plating:

Underplating and U-Slot: 100 μ" [ 2.54 μm ] Nickel

Wiping Area: 30 μ" [ 0.76 μm ] Gold

Wire Accommodation: 26 and 28 AWG Stranded

Marking: 3M Logo, Part Identification Number, and Orientation Triangle

## Electrical

Current Rating: 1 A

Insulation Resistance:  $> 1 \times 10^9 \Omega$  at 500 V<sub>DC</sub>

Withstanding Voltage: 1000 V<sub>RMS</sub> at Sea Level

## Environmental

Temperature Rating: -55°C to +105°C

\*\*RoHS compliant" means that the product or part does not contain any of the following substances in excess of the following maximum concentration values in any homogeneous material, unless the substance is in an application that is exempt under RoHS: (a) 0.1% (by weight) for lead, mercury, hexavalent chromium, polybrominated biphenyls or polybrominated diphenyl ethers; or (b) 0.01% (by weight) for cadmium. Unless otherwise stated by 3M in writing, this information represents 3M's knowledge and belief based upon information provided by third party suppliers to 3M.

UL File No.: E68080

# 3M™ Wiremount Socket

.100" × .200" for .050" Pitch Cable

3000 Series

Contact Quantity	3M Part Number		Dimensions			Keying Slots Provided
	Socket	Strain Relief	A	B	C Ref	
20	3575-0000	3448-30	1.18 [ 30.0 ]	1.06 [ 26.9 ]	1.0 [ 25 ]	4
26	3501-0000	3448-28	1.48 [ 37.6 ]	1.36 [ 34.5 ]	1.3 [ 33 ]	6
34	3310-0000	3448-29	1.88 [ 47.8 ]	1.76 [ 44.7 ]	1.7 [ 43 ]	8
40	3318-0000	3448-27	2.18 [ 55.4 ]	2.06 [ 52.3 ]	2.0 [ 51 ]	9
50	3307-0000	3448-17	2.68 [ 68.1 ]	2.56 [ 65.0 ]	2.5 [ 64 ]	12

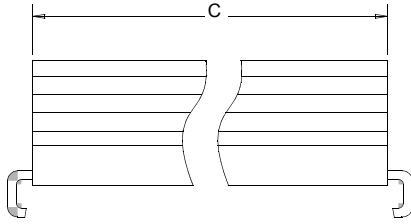

Optional Strain Relief 3M Part No. 3448-XX

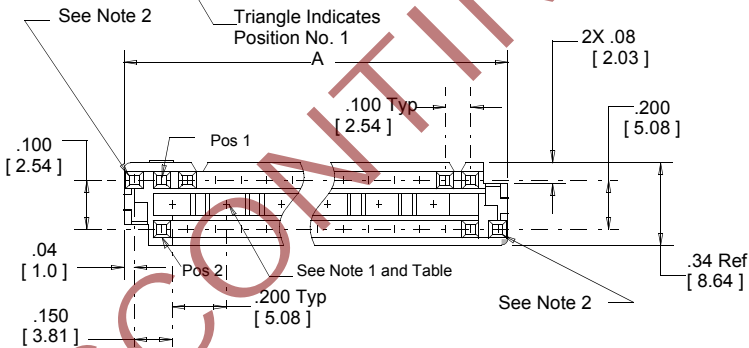
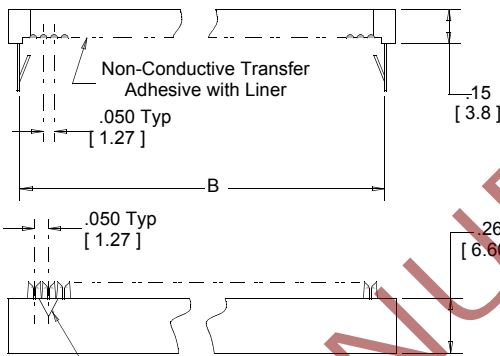
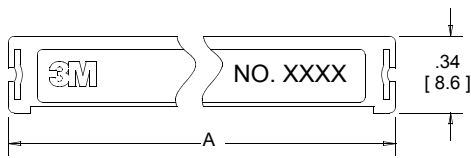

Material:  
Gray Extruded  
Polyvinyl Chloride

.620 ± .025  
[ 15.75 ]

Inch  
[mm]

Tolerance Unless Noted			
	.0	.00	.000
inch	±.1	±.01	±.005

[ ] Dimensions for Reference Only

Material:  
Nickel Plated Steel Music  
Wire, Ø .043 [ 1.09 ]

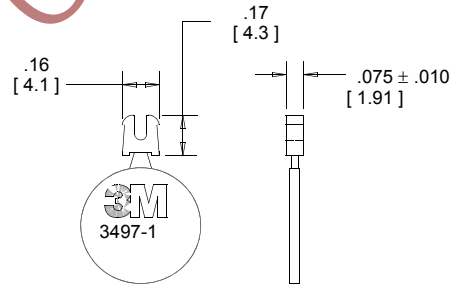

Optional Keying Plug  
3M Part No. 3497-1

Material: Gray Polyester (PBT)

Notes:

1. These holes accept 3M Keying Plug 3497-1 for keying the socket connector without pin loss.
2. Guide holes for Pinless Shroud.
3. Order Pinless Shroud separately.

## Ordering Information

**Sockets  
XXXX-0000**

Socket Series: See Table for 3M Part Number

**Strain Relief  
3448-XX**

3M Part Number:  
See Table

Assembly tools: 3M™ Press 3640 (or equivalent), 3M™ Locator Plate 3443-94, 3M™ Platen 3442-9.

TS-0097-B  
Sheet 2 of 4

# 3M™ Wiremount Socket

.100" x .200" Shroud For Keying Wiremount Socket

3000 Series

**Pinless Shroud**

Material: Gray Polyester (PBT)

**Retainer Clip - 3M Part No. 3619**

Material: .010 [0.25] Stainless Steel

**Section A-A**

Contact Quantity	3M Part Number	Dimension A	Keying Bumps Provided
20	<b>3670</b>	1.18 [30.0]	4
26	<b>3556</b>	1.48 [37.6]	6
34	<b>3321</b>	1.88 [47.8]	8
40	<b>3396</b>	2.18 [55.4]	9
50	<b>3404</b>	2.68 [68.1]	12

**Optional Polarizing Key 3M Part No. 3518**

Material: Gray Polyester (PBT)

**Notes:**

1. Accepts .025 ± .001 [0.64] Square Post.
2. Notches will accommodate 3M Polarizing Key 3518.
3. Provides Keying without pin loss.
4. Retainer Clips (3M Part No. 3619) snaps on the two opposing corners for retention to pins.
5. Two corner pins act as stand-offs to control pin length for mating socket.

**Ordering Information**

**Pinless Shroud**  
**XXXX**

3M Part Number:  
See Table

**Retainer Clip**  
**3619**

**Polarizing Keys**  
**3518**

TS-0097-B  
Sheet 3 of 4

# 3M™ Wiremount Socket

.100" × .200" for .050" Recommended Board Pin Pattern

3000 Series

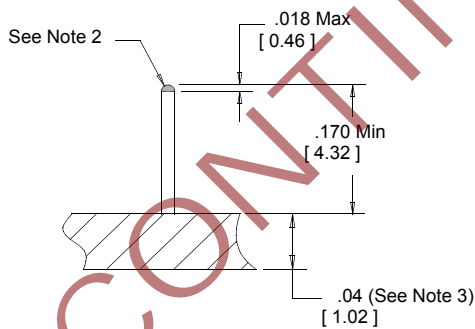
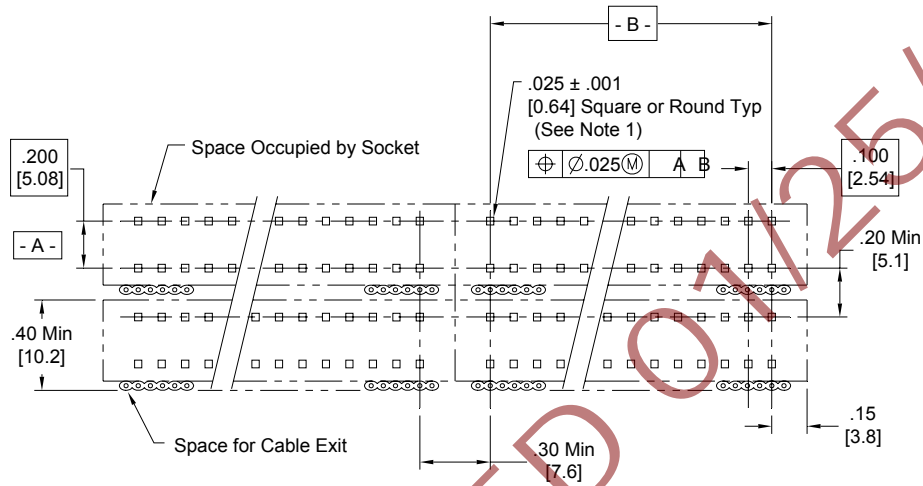

Notes:

1. Measured at tip.
2. Tapered Pin Tip configuration recommended.
3. Pinless Shroud base thickness; When the Header Retainer Clip is used, the minimum overall pin length is .36" [9.14].

TS-0097-B  
Sheet 4 of 4

DESIGN CONTINUED 01/25/2017

### Important Notice

All statements, technical information, and recommendations related to 3M's products are based on information believed to be reliable, but the accuracy or completeness is not guaranteed. Before using this product, you must evaluate it and determine if it is suitable for your intended application. You assume all risks and liability associated with such use. Any statements related to the product which are not contained in 3M's current publications, or any contrary statements contained on your purchase order shall have no force or effect unless expressly agreed upon, in writing, by an authorized officer of 3M.



### 3M Electronics

6801 River Place Blvd.  
Austin, TX 78726-9000  
800/225-5373  
[www.3M.com/electronics](http://www.3M.com/electronics)

### Warranty; Limited Remedy; Limited Liability.

This product will be free from defects in material and manufacture for a period of one (1) year from the time of purchase. **3M MAKES NO OTHER WARRANTIES INCLUDING, BUT NOT LIMITED TO, ANY IMPLIED WARRANTY OF MERCHANTABILITY OR FITNESS FOR A PARTICULAR PURPOSE.** If this product is defective within the warranty period stated above, your exclusive remedy shall be, at 3M's option, to replace or repair the 3M product or refund the purchase price of the 3M product. **Except where prohibited by law, 3M will not be liable for any indirect, special, incidental or consequential loss or damage arising from this 3M product, regardless of the legal theory asserted.**



Minimum 10%  
Post-Consumer Fiber

Printed in USA.

© 3M 2007