

TAS5132DDV6EVM

This user's guide describes the operation of the evaluation module for the TAS5132 Digital Amplifier Power Output Stage using the TAS5086 Digital Audio PWM Processor from Texas Instruments. The document also provides measurement data and design information including the schematic, the bill of materials, and the PCB layout.

Contents

1	Overview	2
2	Quick Setup Guide	4
3	Protection	6
4	TAS5132DDV6EVM Performance.....	7
5	Relevant Texas Instruments Data Sheets	21
Appendix A	Design Documents	23

List of Figures

1	Integrated PurePath Digital™ Amplifier System	3
2	Physical Structure for TAS5132DDV6EVM (Approximate Layout).....	4
3	TAS5086 GUI Window	6
4	THD+N vs Power (SE – 3 Ω)	9
5	THD+N vs Power (SE – 4 Ω)	10
6	THD+N vs Power (BTL – 6 Ω).....	10
7	THD+N vs Power (BTL –8 Ω)	11
8	THD+N vs Frequency (SE – 3 Ω).....	11
9	THD+N vs Frequency (SE – 4 Ω).....	12
10	THD+N vs Frequency (BTL – 6 Ω)	12
11	THD+N vs Frequency (BTL – 8 Ω)	13
12	FFT Spectrum With –60-dBFS Tone (SE)	13
13	FFT Spectrum With –60-dBFS Tone (BTL).....	14
14	Idle Noise FFT Spectrum (SE)	14
15	Idle Noise FFT Spectrum (BTL).....	15
16	Channel Separation (1-2)	15
17	Channel Separation (4-5)	16
18	Channel Separation (5-6)	16
19	Frequency Response (SE).....	17
20	Frequency Response (BTL)	17
21	High-Current Protection (SE)	18
22	High-Current Protection (BTL).....	18
23	Pop/Click (SE) Time Domain	19
24	Pop/Click (SE) FFT ($V_{REF} = 5.49$ Vrms).....	19
25	Pop/Click (BTL) Time Domain.....	20
26	Pop/Click (BTL) FFT ($V_{REF} = 11.19$ Vrms).....	21
27	Output Stage Efficiency	21

List of Tables

1	TAS5132DDV6EVM Specification.....	2
2	Recommended Supply Voltages	5

3	TAS5132 Warning/Error Signal Decoding.....	7
4	General Test Conditions	7
5	TAS5086 Register Settings	7
6	Electrical Data.....	8
7	Audio Performance	8
8	Thermal Specification	8
9	Physical Specifications.....	9

1 Overview

The TAS5132DDV6EVM PurePath Digital™ customer evaluation module demonstrates the integrated circuits TAS5132DDV and TAS5086DBT from Texas Instruments (TI).

The TAS5132 is an integrated stereo digital amplifier power stage with an advanced protection system. The TAS5132 is capable of driving a 6-Ω bridge-tied load at up to 25 W per channel with low integrated noise at the output, low THD+N, and low idle power dissipation.

The TAS5086 is a six-channel digital pulse-width modulator (PWM) that provides advanced performance and a high level of system integration. The TAS5086 is designed to interface seamlessly with most audio digital signal processors and MPEG decoders, accepting a wide range of input data and clock formats.

This EVM is configured with four single-ended (SE) channels and two bridge-tied load (BTL) channels for center and subwoofer channel.

Together with a TI input-USB board, this EVM is a complete 5.1-channel digital audio amplifier system which includes digital input (S/PDIF), analog inputs, interface to PC, and DAP features like digital volume control, input and output multiplexers, and automute. A configuration option is available for power-stage failure protection.

Table 1. TAS5132DDV6EVM Specification

Key Parameters	
Output stage supply voltage	0 V – 18 V
System supply Voltage	15 V – 20 V
Number of channels	4x SE, 2x BTL
Load impedance SE	3 Ω– 4 Ω
Load impedance BTL	6 Ω– 8 Ω
Output power SE	9 W/ 4 Ω/ 10% THD or 12.5 W/ 3 Ω/ 10% THD
Output power BTL	20 W/ 8 Ω / 10% THD or 26 W/ 6 Ω / 10% THD
DNR	>105 dB
PWM processor	TAS5086DBT
Output stage	TAS5132DDV

This 5.1-channel system is designed for home theater applications such as DVD receivers, DVD mini-component systems or home theater in a box (HTIB), and LCD TVs.

This document covers EVM specifications, audio performance, and power-efficiency measurement graphs, and design documentation that includes schematics, parts list, layout, and mechanical design.

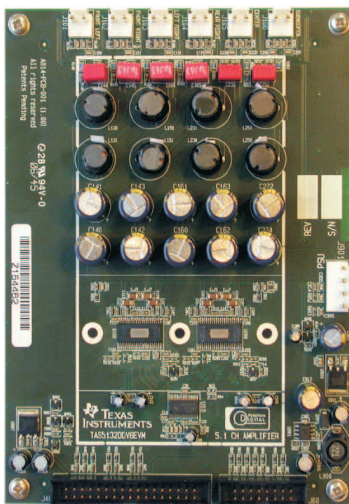

Gerber (layout) files are available on the TI Web site at www.ti.com.

The EVM is delivered with cables and an input-USB board for connection to an input source and for control by a personal computer.

1.1 TAS5132DDV6EVM Features

- 6-channel PurePath Digital™ evaluation module (double-sided, plated-through PCB layout).
- Self-contained protection system (short circuit and thermal).
- Standard I²S and I²C/control connector for TI input board
- Double-sided, plated-through PCB layout.

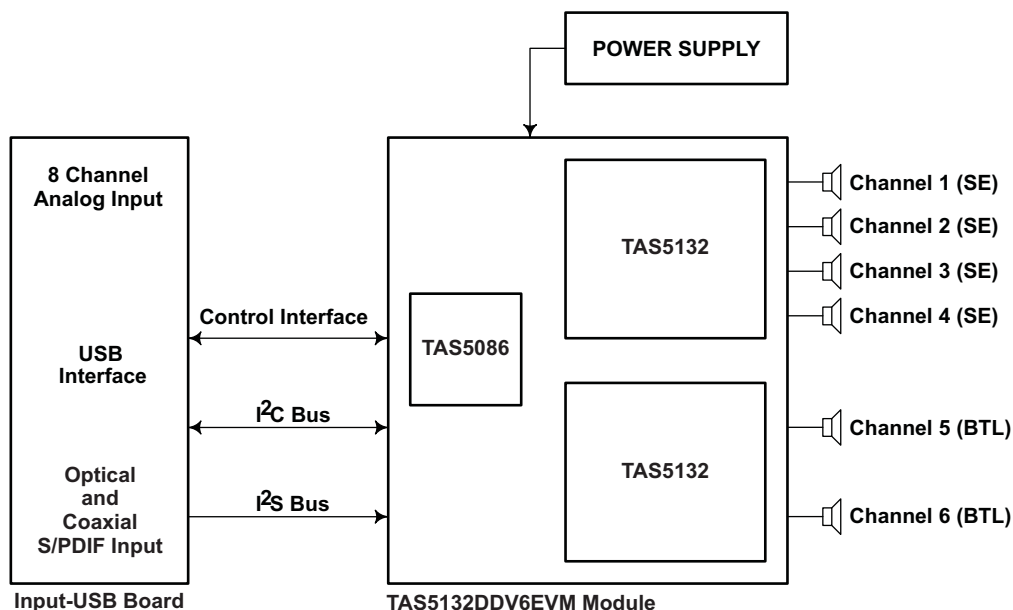

Figure 1. Integrated PurePath Digital™ Amplifier System

1.2 PCB Key Map

Physical structure for the TAS5132DDV6EVM is illustrated in [Figure 2](#).

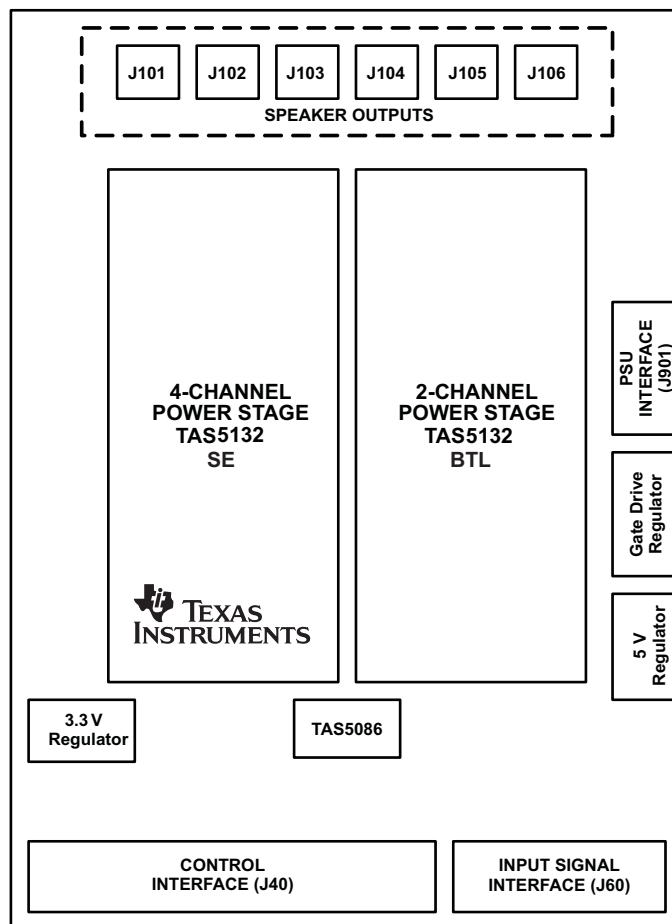

Figure 2. Physical Structure for TAS5132DDV6EVM (Approximate Layout)

2 Quick Setup Guide

This section describes the TAS5132DDV6EVM board in regards to power supplies and system interfaces. It provides information regarding handling and unpacking, absolute operating conditions, and a description of the factory default switch and jumper configuration.

This section also provides a step-by-step guide to configuring the TAS5132DDV6EVM for device evaluation.

2.1 Electrostatic Discharge Warning

Many of the components on the TAS5132DDV6EVM are susceptible to damage by electrostatic discharge (ESD). Customers are advised to observe proper ESD handling precautions when unpacking and handling the EVM, including the use of a grounded wrist strap at an approved ESD workstation.

CAUTION

Failure to observe ESD handling procedures can result in damage to EVM components.

2.2 Unpacking the EVM

On opening the TAS5132DDV6EVM package, ensure that the following items are included:

- 1 pc. TAS5132DDV6EVM board using one TAS5086DBT and two TAS5132DDV.
- 1 pc. TI Input-USB board for interfacing TAS5132DDV6EVM with SPDIF/analog sources and PC for control.
- 1 pc. Signal interface IDC cable for connection to an I²S front-end like the attached TI Input-USB board.
- 1 pc. Control interface IDC cable for connection to an I²C front-end like the attached TI Input-USB board.
- 1 pc Cable for connecting Input-USB board to a USB port on a PC for TAS5086 control by software.
- 1 pc. Power supply cable for two regulated power supplies (H-bridge and system supply).
- 1 pc. PurePath CD-ROM

If any of these items is missing, contact the Texas Instruments Product Information Center nearest you to inquire about a replacement.

Connect Input-USB board to TAS5132DDV6EVM using the two delivered IDC cables.

2.3 Power Supply Setup

To power up the EVM, two power supplies are needed. One for system power, logic, and gate-drive, and one for output stage supply. Power supplies are connected to the EVM using delivered power cable red/black, white/black.

A single 15-V to 18-V power supply can be used if the user connects black/black to GND and red/white to 15/18 V.

Table 2. Recommended Supply Voltages

Description	Voltage Limitations	Current Requirement	Cable
System power supply	15 V – 20 V	0.3 A	Red/black
Output stage power supply	0 V – 18 V	2 A	White/black

CAUTION

Applying voltages above the limitations given in [Table 2](#) can cause permanent damage to your hardware

Note: The length of power supply cable must be minimized. Increasing length of PSU cable is equal to increasing the distortion for the amplifier at high output levels and low frequencies.

2.4 Speaker Connection

CAUTION

Both positive and negative speaker outputs are floating and may not be connected to ground (e.g., through an oscilloscope)

2.5 GUI Software Installation

The TAS5086 GUI provides easy control of all registers in TAS5086. To install the GUI, run the setup file from the PurePath CD-ROM.

After installation, turn on the power supplies and connect the USB cable to the Input-USB board.

Start the GUI program from Windows™ menu. Start-up of the GUI takes a few seconds.



Figure 3. TAS5086 GUI Window

From the files menu, load the configuration file:

TAS5132DDV6EVM Configuration (2.00).cfg

The file is located on the PurePath CD-ROM. This file contains all settings for a default setup of the EVM.

For easy access of the file, it is recommended to copy the files into a directory where the GUI is installed. Default is C:\Program Files\Texas Instruments Inc\TAS5086\

For more advanced use of the GUI, see the GUI User's Guide and the TAS5086 data sheet ([SLES131](#)).

3 Protection

This section describes the short-circuit protection and fault-reporting circuitry of the TAS5132 device.

3.1 Short-Circuit Protection and Fault-Reporting Circuitry

The TAS5132 is a self-protecting device that provides fault reporting (including high-temperature protection and short-circuit protection). TAS5132 is configured in back-end auto-recovery mode and therefore resets automatically after all errors (M1, M2, and M3 are set low); see the TAS5086 data sheet for further explanation. This means that the device restarts itself after an error occasion and reports shortly through the \overline{SD} error signal.

3.2 Fault Reporting

The \overline{OTW} and \overline{SD} outputs from TAS5132 indicate fault conditions. See the TAS5132 data sheet ([SLES190](#)) for a description of these pins.

Table 3. TAS5132 Warning/Error Signal Decoding

\overline{OTW}	\overline{SD}	Device Condition
0	0	High-temperature error and/or high-current error
0	1	High-temperature warning
1	0	Undervoltage lockout or high-current error
1	1	Normal operation, no errors/warnings

The temperature warning signals at the TAS5132DDV6EVM board are wired-OR to one temperature warning signal (\overline{OTW} — pin 22 in control interface connector). Shutdown signals are wired-OR into one shutdown signal (\overline{SD} — pin 20 in control interface connector).

The shutdown signals together with the temperature warning signal give chip state information as described in [Table 3](#). Device fault reporting outputs are open-drain outputs.

4 TAS5132DDV6EVM Performance

Table 4. General Test Conditions

General Test Conditions		Notes
Output stage supply voltage:	18 V	Laboratory power supply (EA-PS 7065-10A)
System supply voltage:	15 V	
Load impedance SE:	4 Ω	
Load impedance BTL:	8 Ω	
Input signal 1-kHz sine		
Sampling frequency	48 kHz	
Gain setting in TAS5086	0 dB	
Measurement filter	AES17	
TI input-USB board	Input-USB	Rev 10
EVM configuration file	Version 2.00	TAS5132DDV6EVM configuration (2.00).cfg

Table 5. TAS5086 Register Settings⁽¹⁾

Register	Register	Value	Notes
Oscillator trim register	0x1B	00	Initiate factory trim
Split-capacitor register	0x1A	1C	Set split-capacitor charge period to 4160 ms
Master volume register	0x07	30	Master volume set to 0 dB
Modulation limit register	0x10	04	Modulation index set to 96.1%
PWM start register	0x18	30	Channel 1-4 set to start part 2
			Channel 5-6 set to start part 1

⁽¹⁾ These register settings are used for all test, unless otherwise specified.

Table 5. TAS5086 Register Settings (continued)

Register	Register	Value	Notes
Input multiplexer register	0x20	00 01 23 45	
Output multiplexer register	0x25	00 01 23 45	
System control register	0x05	20	PWM start

Table 6. Electrical Data

Electrical Data		Notes/Conditions
Ch 1-4 output power, 3 Ω :	9 W	1 kHz, unclipped (0 dBFS), $T_A = 25^\circ\text{C}$
Ch 1-4 output power, 3 Ω : (10% THD+N)	12.5 W	1 kHz, $T_A = 25^\circ\text{C}$
Ch 1-4 output power, 4 Ω :	7.5 W	1 kHz, unclipped (0 dBFS), $T_A = 25^\circ\text{C}$
Ch 1-4 output power, 4 Ω : (10% THD+N)	10 W	1 kHz, $T_A = 25^\circ\text{C}$
Ch 5-6 output power, 6 Ω :	20 W	1 kHz, unclipped (0 dBFS), $T_A = 25^\circ\text{C}$
Ch 5-6 output power, 6 Ω : (10% THD+N)	26 W	1 kHz, $T_A = 25^\circ\text{C}$
Ch 5-6 output power, 8 Ω :	15.5 W	1 kHz, unclipped (0 dBFS), $T_A = 25^\circ\text{C}$
Ch 5-6 output power, 8 Ω : (10% THD+N)	21 W	1 kHz, $T_A = 25^\circ\text{C}$
Ch 1-4 maximum peak current:	> 3.0 A	1 kHz burst, 1 Ω , ROC = 39 k Ω
Ch 5-6 maximum peak current:	> 5.2 A	1 kHz burst, 1 Ω , ROC = 22 k Ω
Ch 1-4 damping factor:	10	1 kHz, relative to 4- Ω load
Ch 5-6 damping factor:	10	1 kHz, relative to 8- Ω load
Output stage efficiency:	89 %	1 kHz, 2 \times 7.5 W, 4 Ω + 1 \times 16 W
System supply current:	< 145 mA	1 kHz, -60-dBFS signal (with T1 Input-USB Board)
H-bridge supply current:	< 60 mA	1 kHz, -60-dBFS signal
Total board idle power consumption:	3.3 W	H-bridge supply + system supply, -60-dBFS signal

Table 7. Audio Performance

Audio Performance		Notes/Conditions
Ch 1-4 THD+N, 4 Ω :	1 W	< 0.1% 1 kHz
Ch 1-4 THD+N, 4 Ω :	5 W	< 0.1% 1 kHz
Ch 1-4 THD+N, 4 Ω :	7.5 W	< 0.1% 1 kHz
Ch 5-6 THD+N, 8 Ω :	1 W	< 0.09% 1 kHz
Ch 5-6 THD+N, 8 Ω :	10 W	< 0.09% 1 kHz
Ch 5-6 THD+N, 8 Ω :	15 W	< 0.09% 1 kHz
Ch 1-4 dynamic range:		> 108 dB Reference: rated power, A-weighted, AES17 filter
Ch 1-4 noise voltage		< 20 μVrms A-weighted, AES17 filter
Ch 5-6 dynamic range:		> 108 dB Reference: rated power, A-weighted, AES17 filter
Ch 5-6 noise voltage		< 40 μVrms A-weighted, AES17 filter
Ch 1-4 click/pop		< 10 mV Mute/Unmute, no input signal, 4 Ω , 5.5-second start-up delay
Ch 5-6 click/pop		< 20 mV Mute/Unmute, no input signal, 8 Ω
Ch 1-6 channel separation		> 60 dB 1 kHz, unclipped (0 dBFS)
Ch 1-4 frequency response 200 Hz – 20 kHz		\pm 0.5 dB 7.5 W/ 4 Ω , unclipped (0 dBFS)
Ch 5-6 frequency response 20 Hz – 20 kHz		\pm 0.5 dB 15 W/ 8 Ω , unclipped (0 dBFS)

Table 8. Thermal Specification

General Test Conditions	$T_{\text{DEVICE}}^{(1)}$	Notes/Conditions
Idle, all channels switching	42 $^\circ\text{C}$	1 kHz, 15 minutes, -60 dBFS signal, $T_A = 25^\circ\text{C}$

⁽¹⁾ Measured on devices (average) No heatsink.

Table 8. Thermal Specification (continued)

General Test Conditions	T _{DEVICE} ⁽¹⁾	Notes/Conditions
4 x 1.25 W, 4 Ω + 2 x 2.5 W, 8 Ω (1/8)	57°C	1 kHz, 1 hour, T _A = 25°C
2 x 10 W, 4 Ω + 1 x 20 W, 8 Ω (full power)	92°C	1 kHz, 5 minutes, T _A = 25°C

Table 9. Physical Specifications⁽¹⁾

General Test Conditions		Notes/Conditions
PCB dimensions	112 mm × 154 mm	Width × length (mm)
Total weight	130 g	Components + PCB + mechanics

⁽¹⁾ All electrical and audio specifications are typical values.

4.1 THD+N vs Power (SE - 3 Ω)

Gain: +2.5 dB set in TAS5086

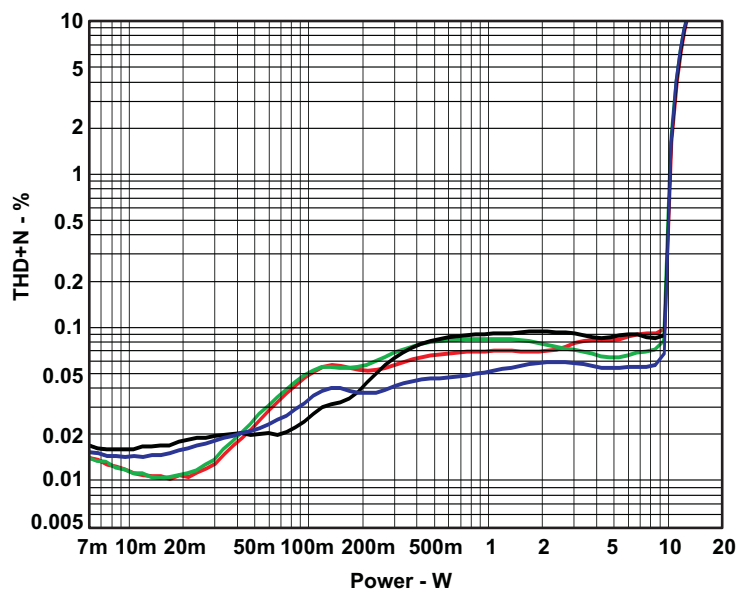

Figure 4. THD+N vs Power (SE – 3 Ω)

4.2 THD+N vs Power (SE - 4 Ω)

Gain: +2.5 dB set in TAS5086

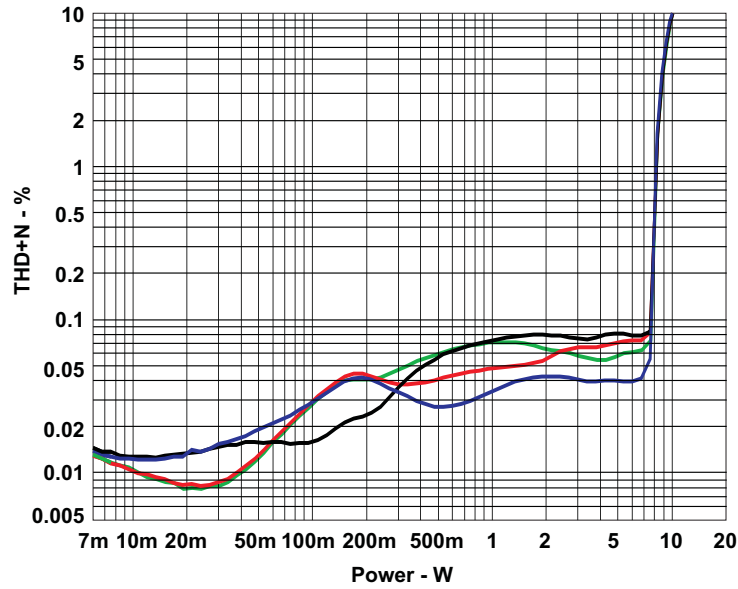

Figure 5. THD+N vs Power (SE – 4 Ω)

4.3 THD+N vs Power (BTL - 6 Ω)

Gain: +2.5 dB set in TAS5086

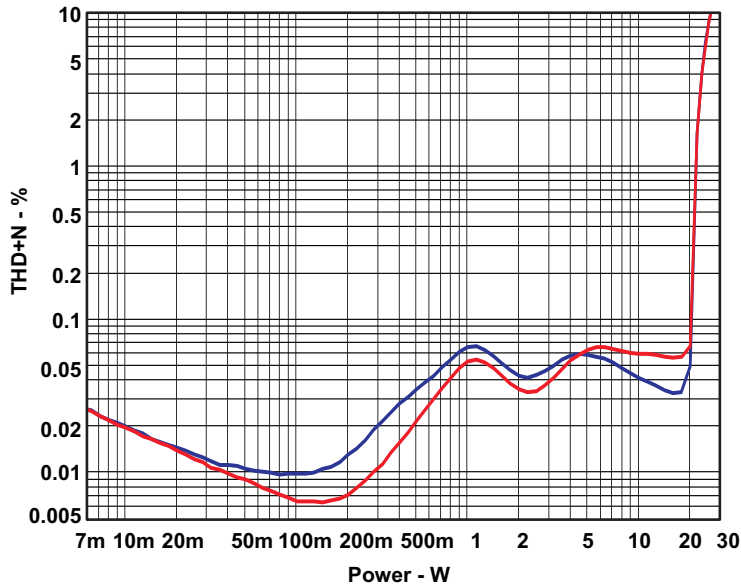

Figure 6. THD+N vs Power (BTL – 6 Ω)

4.4 THD+N vs Power (BTL - 8 Ω)

Gain: +2.5 dB set in TAS5086

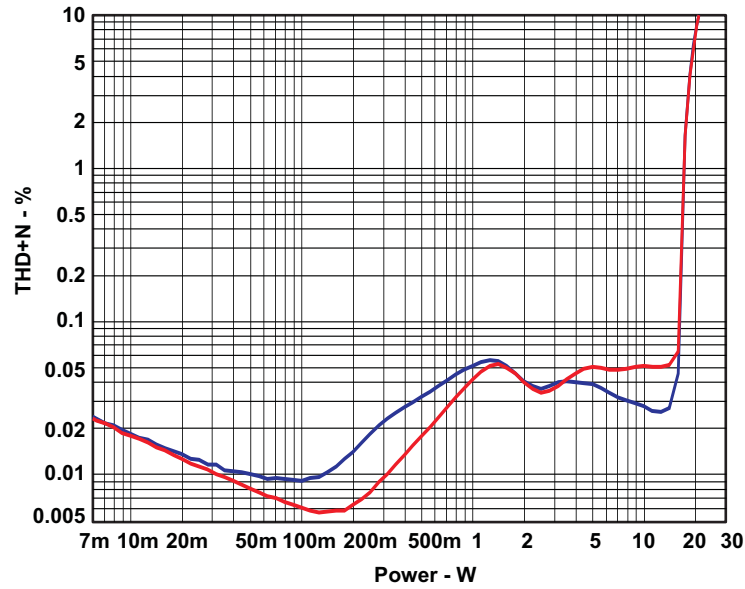

Figure 7. THD+N vs Power (BTL - 8 Ω)

4.5 THD+N vs Frequency (SE - 3 Ω)

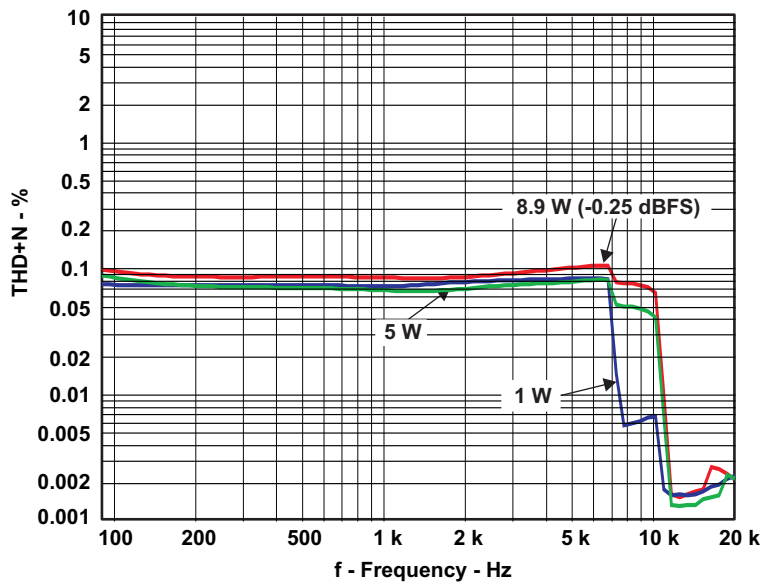

Figure 8. THD+N vs Frequency (SE - 3 Ω)

4.6 THD+N vs Frequency (SE - 4 Ω)

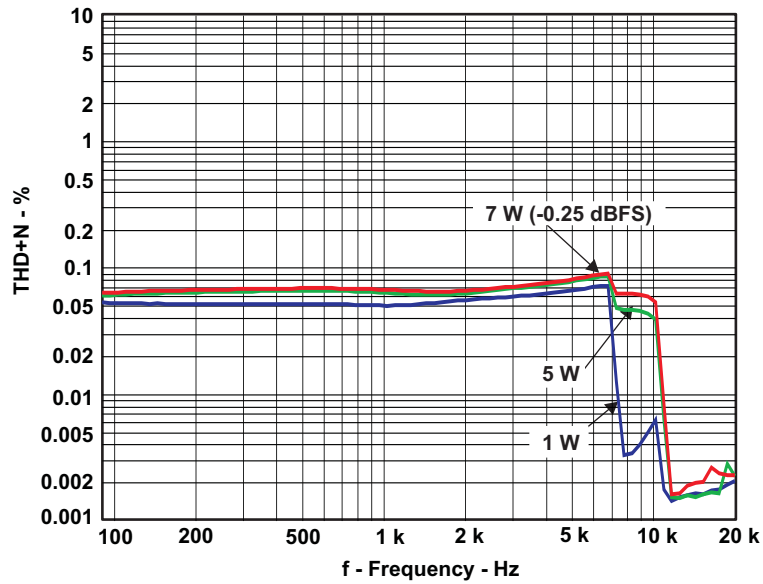

Figure 9. THD+N vs Frequency (SE – 4 Ω)

4.7 THD+N vs Frequency (BTL - 6 Ω)

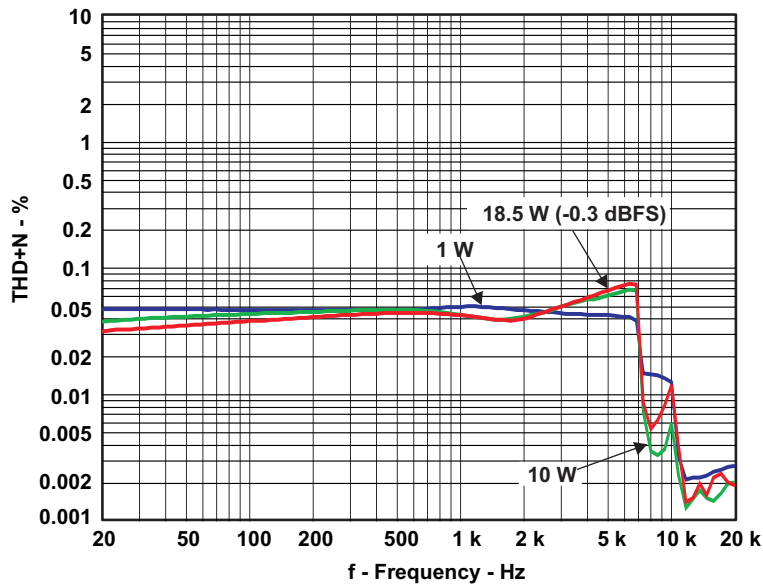

Figure 10. THD+N vs Frequency (BTL – 6 Ω)

4.8 THD+N vs Frequency (BTL - 8 Ω)

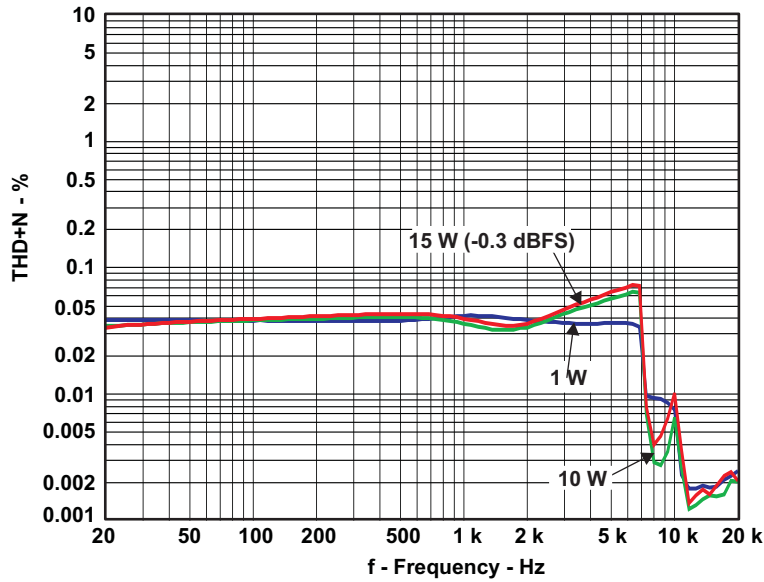

Figure 11. THD+N vs Frequency (BTL – 8 Ω)

4.9 FFT Spectrum with -60-dBFS Tone (SE)

Reference voltage is 5.48 V. FFT size is 16k.

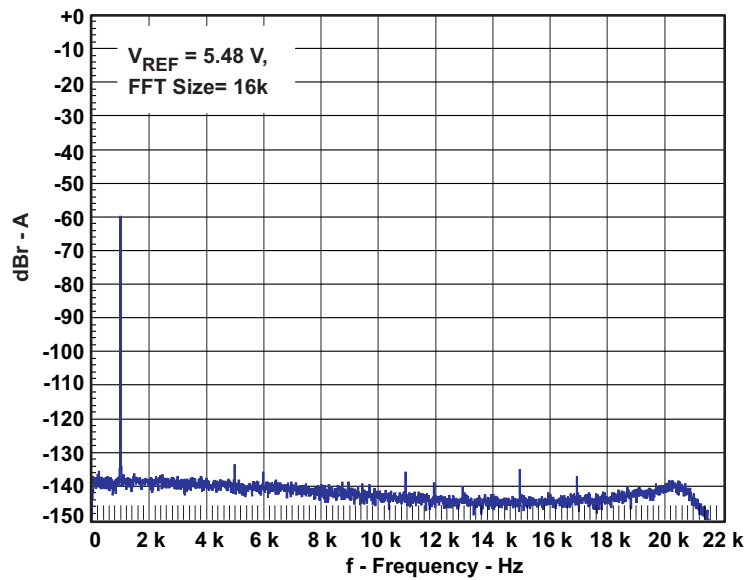

Figure 12. FFT Spectrum With -60-dBFS Tone (SE)

4.10 FFT Spectrum With -60-dBFS Tone (BTL)

Reference voltage is 11.18 V. FFT size is 16k.

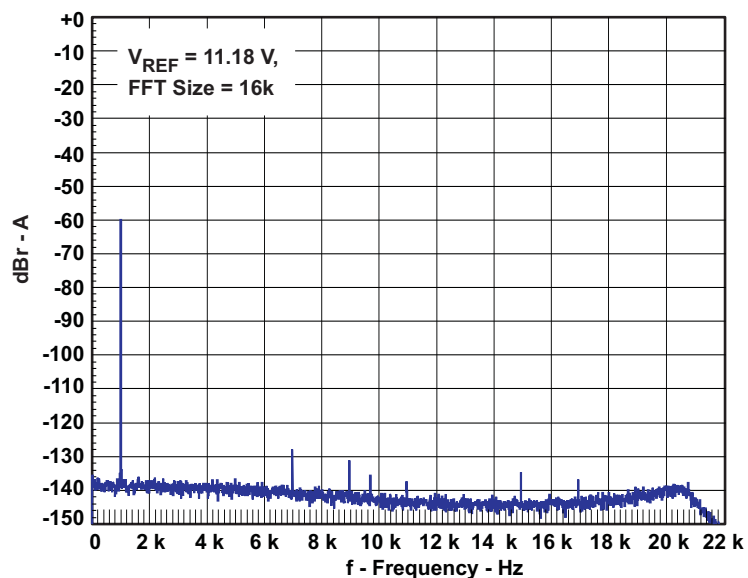

Figure 13. FFT Spectrum With -60-dBFS Tone (BTL)

4.11 Idle Noise FFT Spectrum (SE)

Reference voltage is 5.49 V. FFT size is 16k.

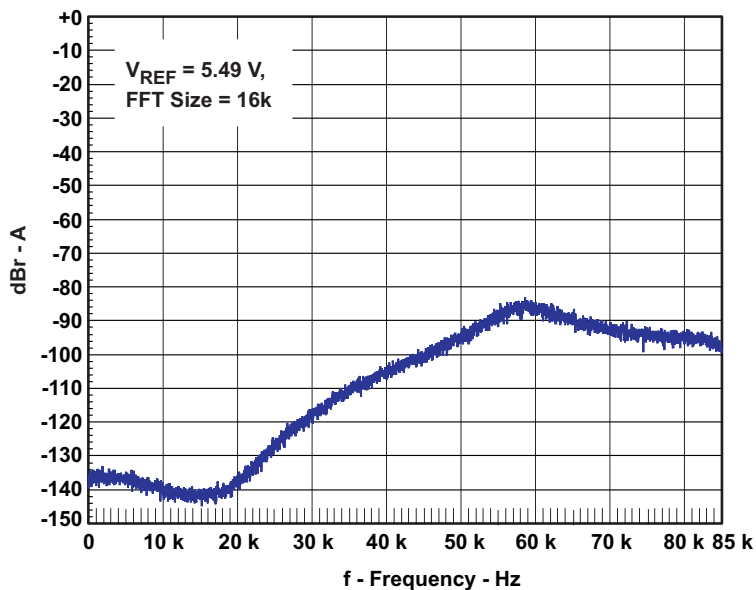

Figure 14. Idle Noise FFT Spectrum (SE)

4.12 Idle Noise FFT Spectrum (BTL)

Reference voltage is 11.18 V. FFT size is 16k.

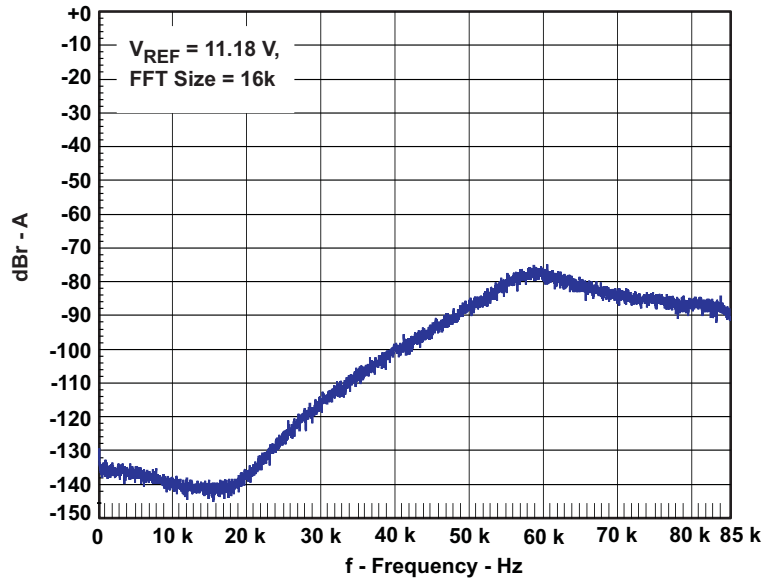

Figure 15. Idle Noise FFT Spectrum (BTL)

4.13 Channel Separation (1-2)

Channel separation is tested for two channels in the same package, channel 1 and channel 2. Four-ohm loads are used for both channels. Channel 1 input signal is 0 dBFS; channel 2 is muted. Reference voltage is 5.49 V_{rms}. Shielded output inductors provide better channel separation.

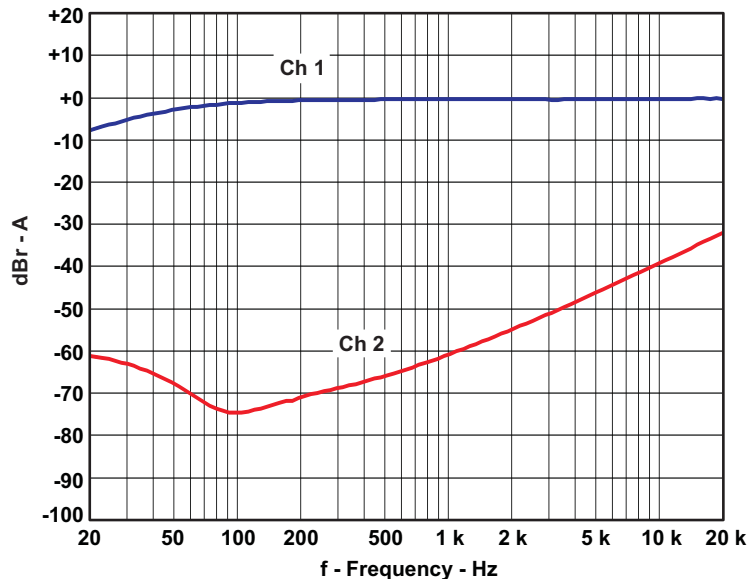

Figure 16. Channel Separation (1-2)

4.14 Channel Separation (4-5)

Channel separation is tested for two channels in a different package, channel 4 and channel 5. A 4- Ω load is used for channel 4 SE; an 8- Ω load is used for channel 5 BTL. The channel 5 input signal is 0 dBFS; channel 4 is muted. Reference voltage is 11.19 Vrms. Shielded output inductors provide better channel separation.

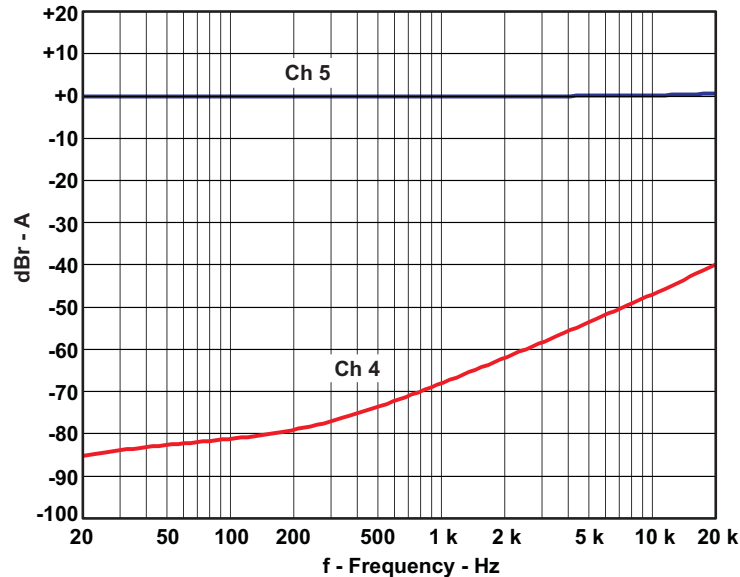

Figure 17. Channel Separation (4-5)

4.15 Channel Separation (5-6)

Channel separation is tested for two channels in the same package, channel 5 and channel 6. Eight-ohm loads are used for both channels. The channel 5 input signal is 0 dBFS; channel 6 is muted. Reference voltage is 11.19 Vrms.

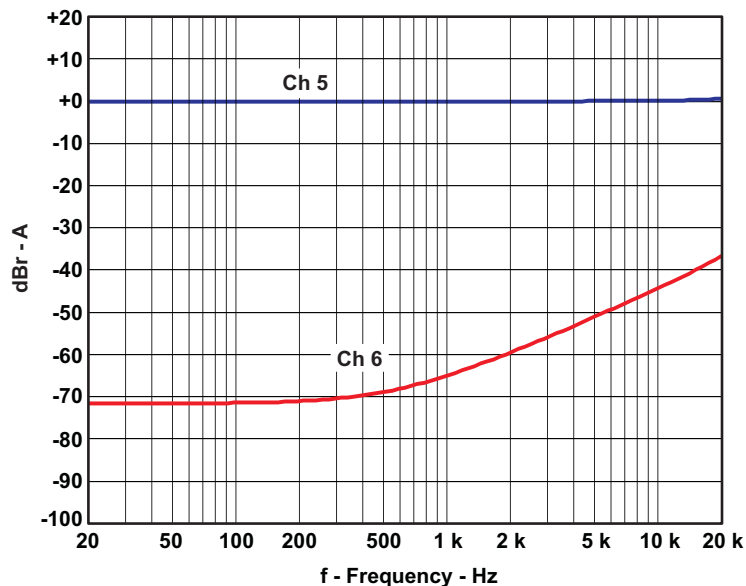

Figure 18. Channel Separation (5-6)

4.16 Frequency Response (SE)

Measurement bandwidth filter is 80 kHz.

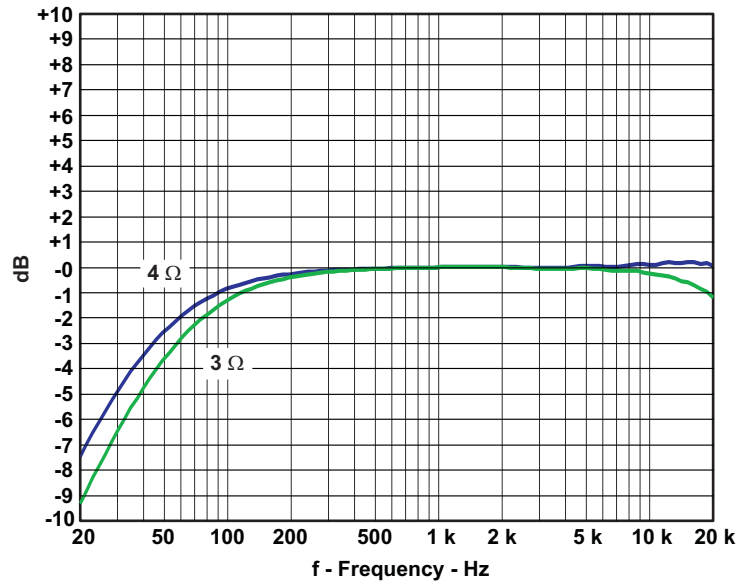

Figure 19. Frequency Response (SE)

4.17 Frequency Response (BTL)

Measurement bandwidth filter is 80 kHz.

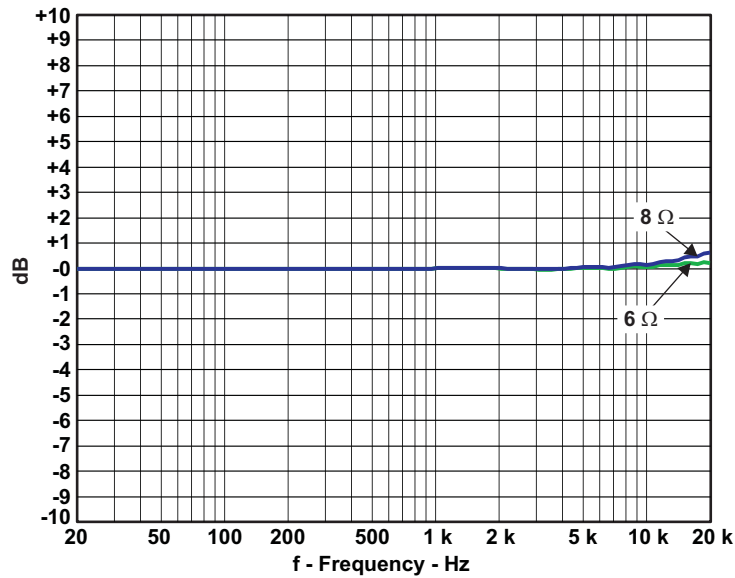

Figure 20. Frequency Response (BTL)

4.18 High-Current Protection (SE)

Input bursted signal is 1 kHz; load is 1 Ω .

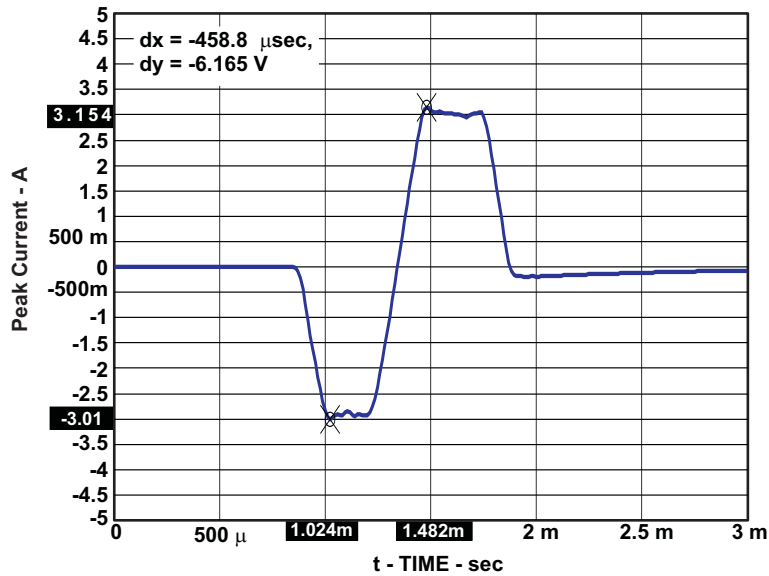

Figure 21. High-Current Protection (SE)

4.19 High-Current Protection (BTL)

Input bursted signal is 1 kHz; load is 1 Ω .

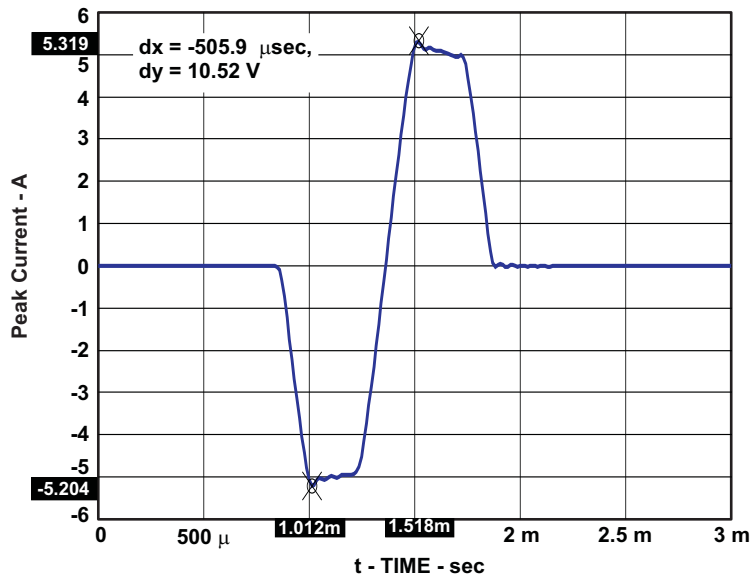

Figure 22. High-Current Protection (BTL)

4.20 Pop/Click (SE)

Start of SE channels is tested for different charge times. Charge time period is controlled by changing register x1Ah in TAS5086. No input signal is applied. Load is 4 Ω. Measurement is done according to [SLEA044](#). The measurement results are presented both in time domain and in frequency domain.

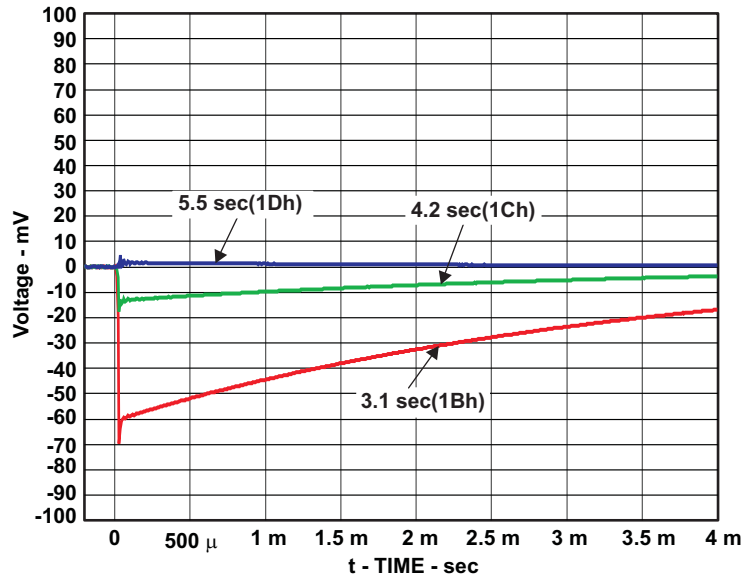

Figure 23. Pop/Click (SE) Time Domain

Reference voltage is 5.49 Vrms.

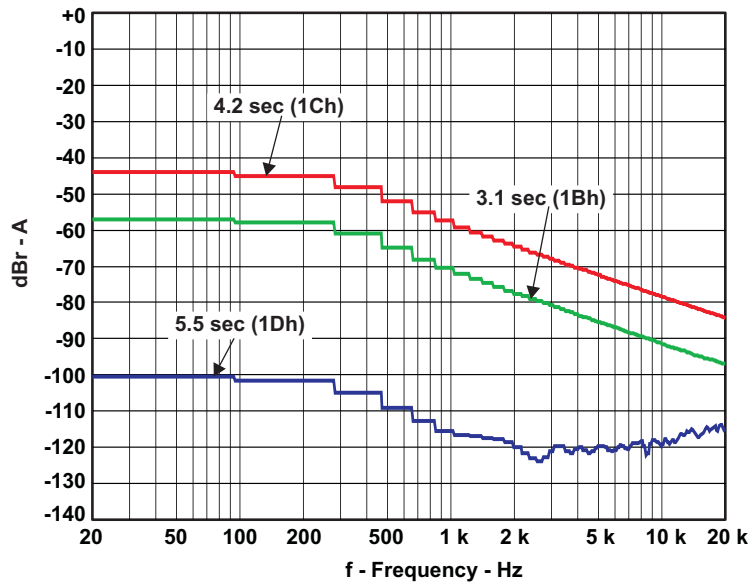

Figure 24. Pop/Click (SE) FFT ($V_{REF} = 5.49$ Vrms)

4.21 Pop/Click (BTL)

No input signal is applied. Measurement results are presented in time domain and in frequency domain.

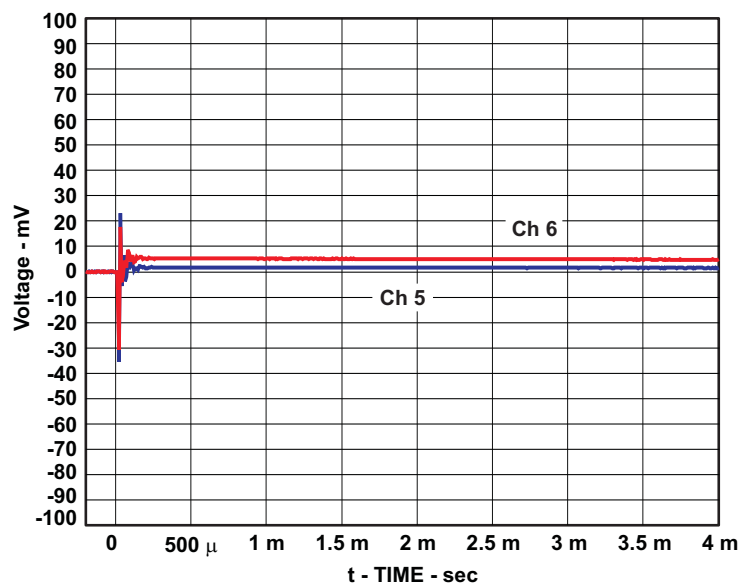

Figure 25. Pop/Click (BTL) Time Domain

Reference voltage is 11.19 Vrms

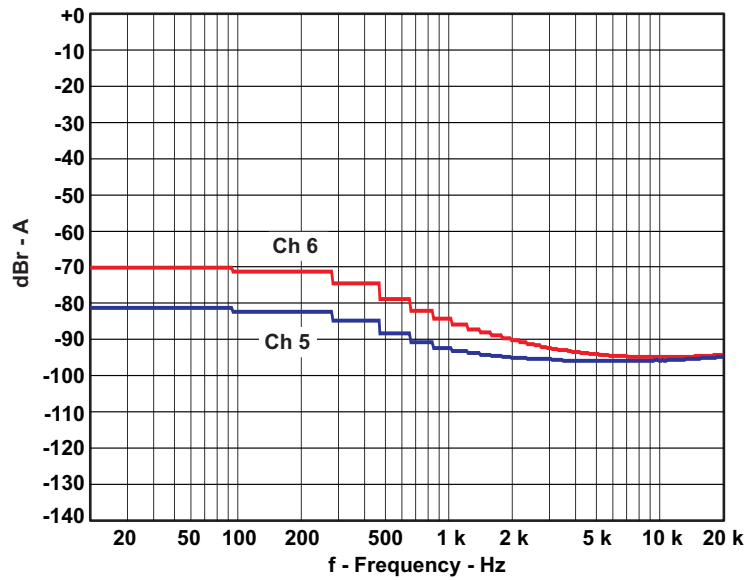

Figure 26. Pop/Click (BTL) FFT ($V_{REF} = 11.19$ Vrms)

4.22 Output Stage Efficiency

Efficiency is tested with two SE channels loaded $4\ \Omega$ and one BTL loaded $8\ \Omega$. The board has been preheated for 1 hour at $1/8$ output power for all channels.

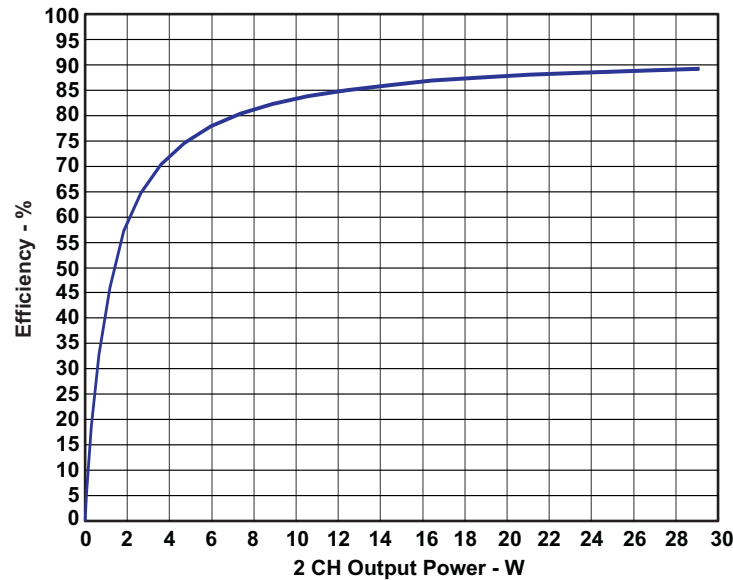

Figure 27. Output Stage Efficiency

5 Relevant Texas Instruments Data Sheets

The following contains a list of data sheets that have detailed descriptions of the integrated circuits used in the design of the TAS5132DDV6EVM. These data sheets can be obtained from the Texas Instruments Web site at <http://www.ti.com>.

Part Number	Literature Number
TAS5086	SLES131
TAS5132	SLES190
TPS5430	SLVS632
TPS3801K33	SLVS219
UA78M12	SLVS059
TLV2217-33	SLVS067

5.1 Additional Documentation

1. *PC Configuration Tool for TAS5086* (TAS5086 GUI ver. 4.0 or later). Located on PurePath CD-ROM.
2. *System Design Considerations for True Digital Audio Power Amplifiers* (SLAA117)
3. *Digital Audio Measurements* ([SLAA114](#))
4. *PSRR for PurePath Digital™ Audio Amplifiers* ([SLEA049](#))
5. *Power Rating in Audio Amplifiers* ([SLEA047](#))
6. *PurePath Digital™ AM Interference Avoidance* ([SLEA040](#))
7. *Click and Pop Measurements Technique* ([SLEA044](#))
8. *Power Supply Recommendations for DVD Receivers* ([SLEA027](#))
9. *Implementation of Power Supply Volume Control* ([SLEA038](#))

Appendix A Design Documents

The following sections comprise this appendix.

- A.1. TAS5132DDV6EVM Schematic
- A.2. TAS5132DDV6EVM Parts List
- A.3. TAS5132DDV6EVM PCB Specification
- A.4. TAS5132DDV6EVM PCB Layers

A.1 TAS5132DDV6EVM Schematic

The TAS5132DDV6EVM schematic drawing sheets are appended to this page.



Design Name: **TAS5132DDV6EVM**
 Type: Mass Market Evaluation Module
 File Name: A814-SCH-001(4.00).DSN
 Version: 4.00
 Date: 10.Jan.2007
 Design Engineer: Tomas Bruunshuus (tbs@ti.com), Jonas Holm (jlh@ti.com)
 Audio Configuration: 5.1 PurePath Digital Amplifier Design
 1 x TAS5086, 2 x TAS5132DDV

Interfaces: J40: 34 pin IDC Header for Control, I2C and +5V
 J60: 16 pin IDC Header for I2S Audio
 J101-J106: 2 pin 3.96mm Headers for Speakers
 J901: 4 pin 3.96mm Header for H-Bridge and System Power Supply

Setup: 4 x 3 ohm and 2 x 6 ohm Speaker Loads
 +18V H-Bridge and +18V System Power Supplies

Performance: 4 x 13W/3ohm (SE) + 2 x 26W/6ohm (BTL) - all 10% THD+N
 105dB Dynamic Range

Page

- 1/6: Front Page and Schematic Disclaimer
- 2/6: Overview - Modulator, Input/Output Connectors
- 3/6: 4 Channel SE Power Stage (FL, FR, SL, and SR)
- 4/6: 2 Channel BTL Power Stage (C and LFE SW)
- 5/6: Power Supplies
- 6/6: Mechanics

Copyright 2006 Texas Instruments, Inc - All rights reserved - The "TI" and "PurePath Digital" logos are trademarks of Texas Instruments.

SCHEMATIC DISCLAIMER

The schematic information and materials ("Materials") provided here are provided by Texas Instruments Incorporated ("TI") as a service to its customers and/or suppliers, and may be used for informational purposes only, and only subject to the following terms. By downloading or viewing these Materials, you are signifying your assent to these terms.

- 1.) These evaluation schematics are intended for use for **ENGINEERING DEVELOPMENT AND EVALUATION PURPOSES ONLY** and are not considered by Texas Instruments to be fit as a basis for establishing production products or systems. This information may be incomplete in several respects, including but not limited to information relating to required design, marketing, and/or manufacturing-related protective considerations and product safety measures typically found in the end-product incorporating the goods.
- 2.) Accordingly, neither TI nor its suppliers warrant the accuracy or completeness of the information, text, graphics, links or other items contained within the Materials. TI may make changes to the Materials, or to the products described therein, at any time without notice. TI makes no commitment to update the Materials.
- 3.) TI assumes no liability for applications assistance, customer product design, software performance, or services that may be described or referenced in the Materials. The user assumes all responsibility and liability for proper and safe design and handling of goods. Accordingly, the user indemnifies TI from all claims arising from its use of the Materials.
- 4.) TI currently deals with various customers for products, and therefore our arrangement with the user will not be exclusive. TI makes no representations regarding the commercial availability of non-TI components that may be referenced in the Materials.
- 5.) No license is granted under any patent right or other intellectual property right of TI covering or relating to any combination, machine, or process in which such TI products or services might be or are used. Except as expressly provided herein, TI and its suppliers do not grant any express or implied right to you under any patents, copyrights, trademarks, or trade secret information.
- 6.) Performance tests and ratings, to the extent referenced in the Materials, are measured using specific computer systems and/or components and reflect the approximate performance of TI products as measured by those tests. Any difference in system hardware or software design or configuration may affect actual performance. Buyers should consult other sources of information to evaluate the performance of systems or components they are considering purchasing.
- 7.) Resale of TI's products or services with statements different from or beyond the parameters stated by TI for that product or service in official TI data books or data sheets voids all express and any implied warranties for the associated TI product or service, and is an unfair and deceptive business practice, and TI is not responsible for any such use.
- 8.) The Materials are copyrighted and any unauthorized use may violate copyright, trademark, and other laws. You may only download one copy for your internal use only, unless you are specifically licensed to do otherwise by TI in writing. This is a license, not a transfer of title, and is subject to the following restrictions: You may not: (a) modify the Materials (including any associated warranties, conditions, limitations or notices) or use them for any commercial purpose, or any public display, performance, sale or rental; (b) decompile, reverse engineer, or disassemble software Materials except and only to the extent permitted by applicable law; (c) remove any copyright or other proprietary notices from the Materials; (d) transfer the Materials to another person. You agree to prevent any unauthorized copying of the Materials. TI may terminate this license at any time if you are in breach of the terms of this Agreement. Upon termination, you will immediately destroy the Materials.
- 9.) **THE MATERIALS ARE PROVIDED "AS IS" WITHOUT ANY EXPRESS OR IMPLIED WARRANTY OF ANY KIND INCLUDING WARRANTIES OF MERCHANTABILITY, NONINFRINGEMENT OF INTELLECTUAL PROPERTY, OR FITNESS FOR ANY PARTICULAR PURPOSE. IN NO EVENT SHALL TI OR ITS SUPPLIERS BE LIABLE FOR ANY DAMAGES WHATSOEVER (INCLUDING, WITHOUT LIMITATION, DAMAGES FOR LOSS OF PROFITS, BUSINESS INTERRUPTION, LOSS OF INFORMATION) ARISING OUT OF THE USE OF OR INABILITY TO USE THE MATERIALS, EVEN IF TI HAS BEEN ADVISED OF THE POSSIBILITY OF SUCH DAMAGES.**

Parts List No.2

TEXAS INSTRUMENTS		DIGITAL AUDIO & VIDEO DIVISION ALL RIGHTS RESERVED - PATENTS PENDING TEXAS INSTRUMENTS INCORPORATED	
Project: TAS5132DDV6EVM		Rev: 4.00	
Page Title: Schematic Disclaimer		Size: A2	
File Name: A814-SCH-001.DSN	Engineer: Tomas Bruunshuus		
Date: Wednesday, January 10, 2007			Page: 1 of 6

TAS5132DDV6EVM

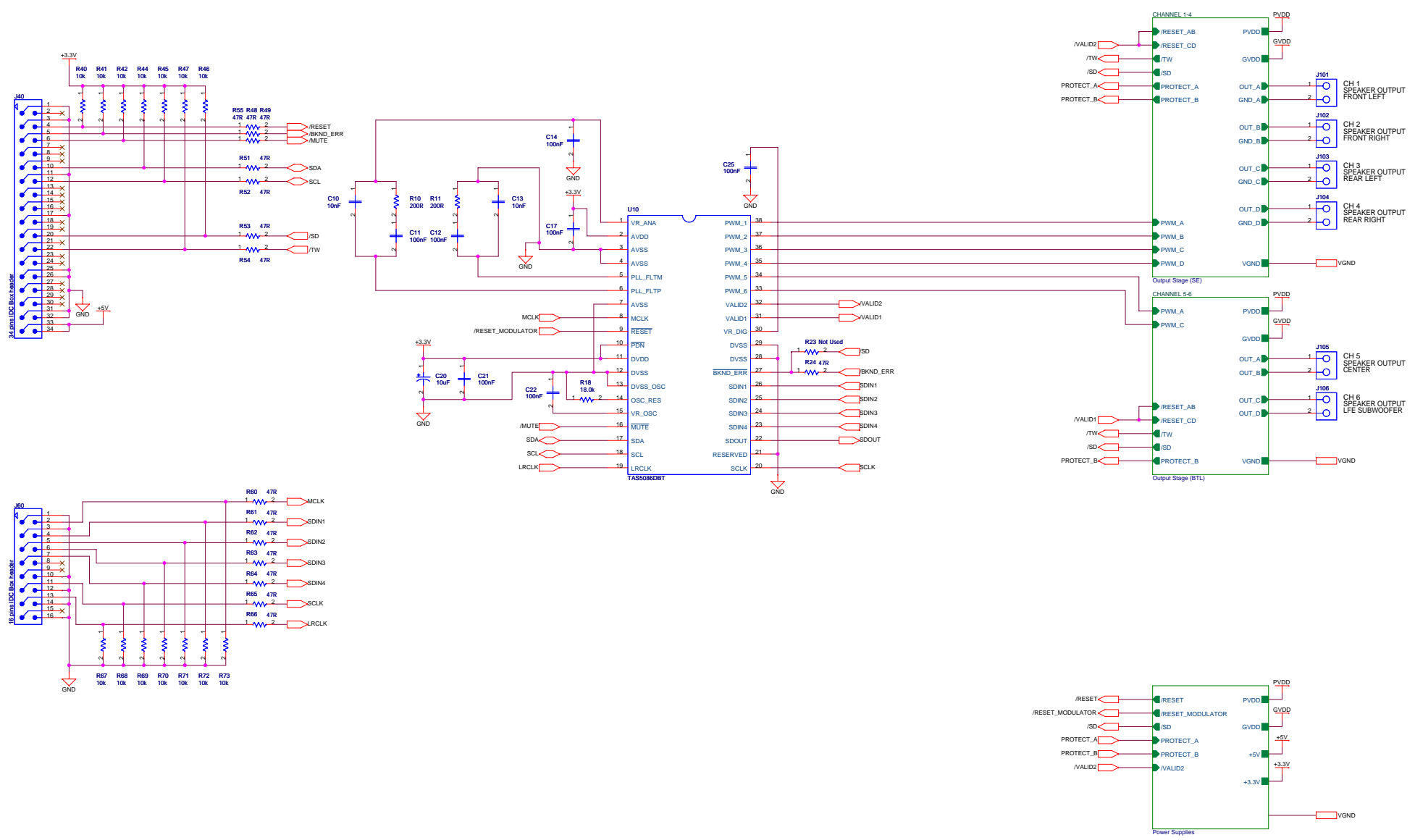

POWER OUTPUT STAGE (BTL)

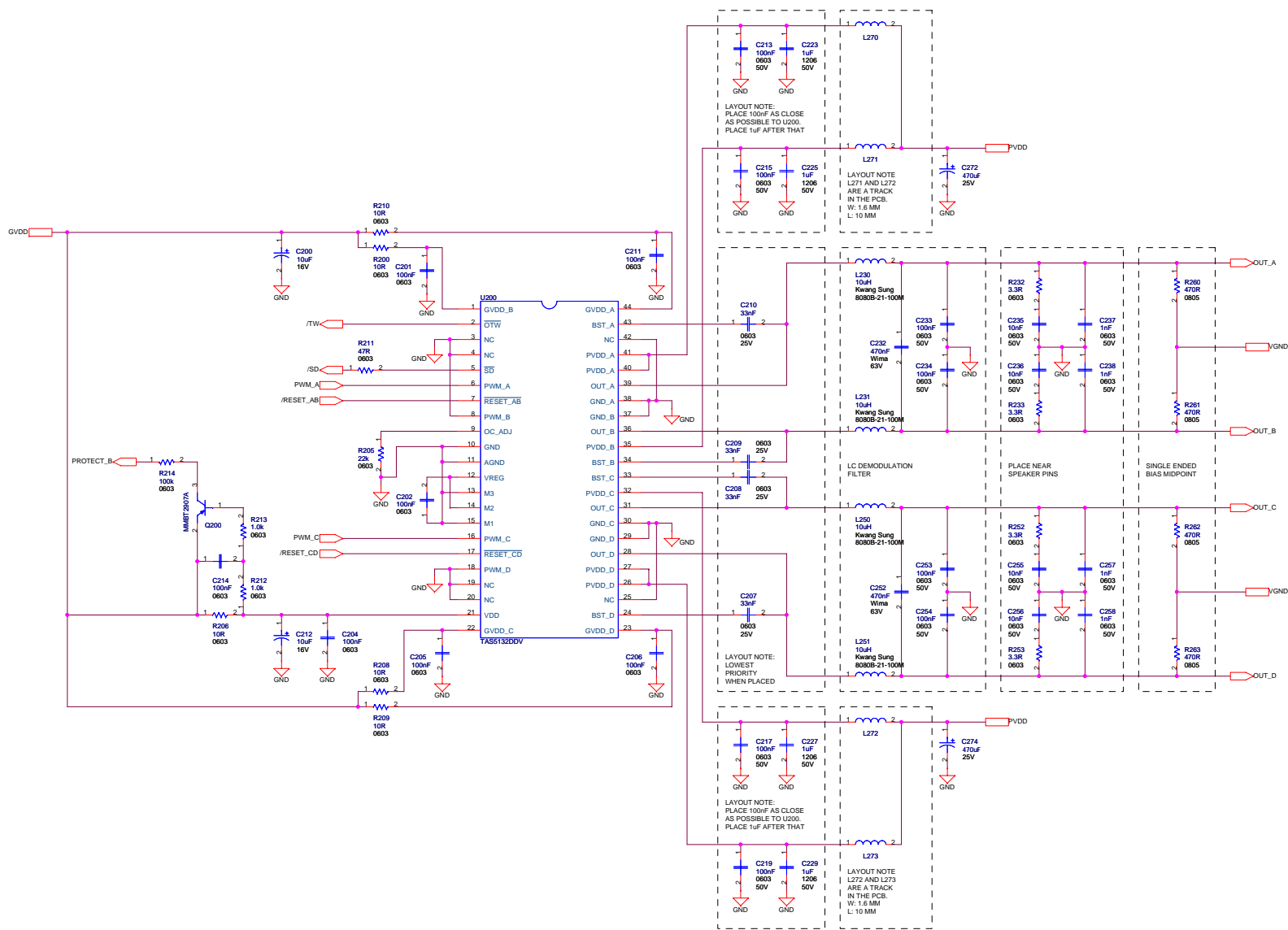

POWER SUPPLIES

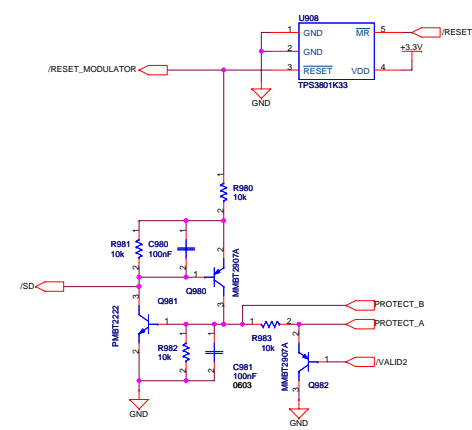
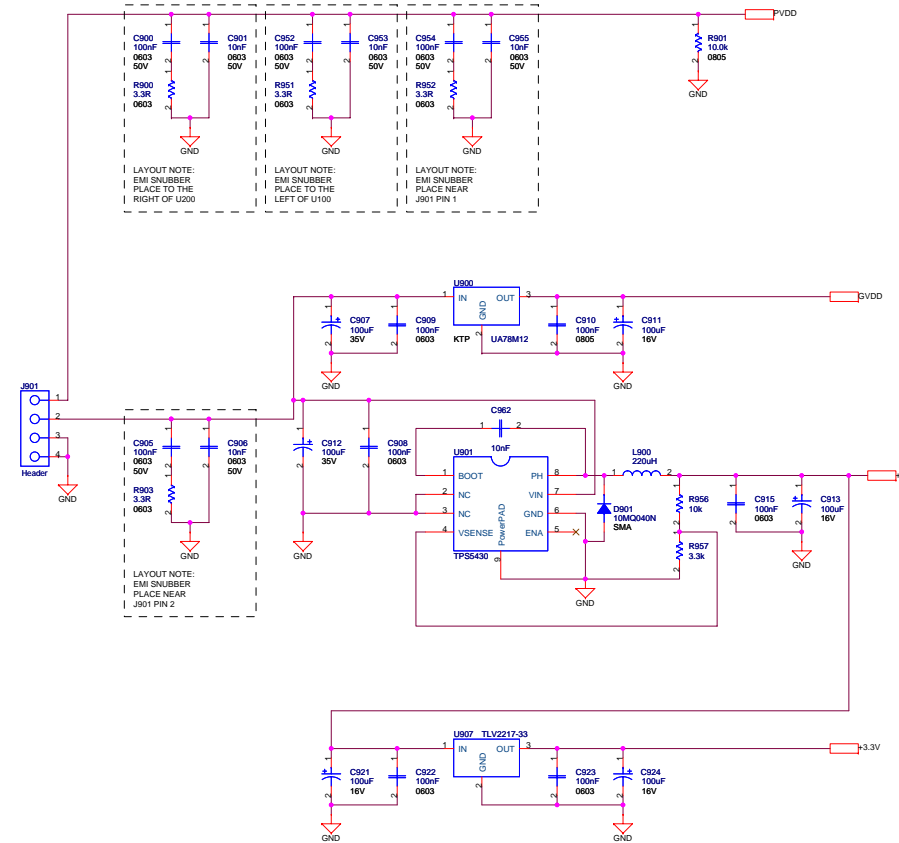

LAYOUT NOTE:
EMI SNUBBER
PLACE TO THE
RIGHT OF U200

LAYOUT NOTE:
EMI SNUBBER
PLACE TO THE
LEFT OF U100

LAYOUT NOTE:
EMI SNUBBER
PLACE NEAR
J901 PIN 1

LAYOUT NOTE:
EMI SNUBBER
PLACE NEAR
J901 PIN 2

MECHANICS

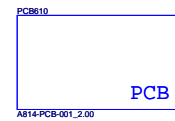
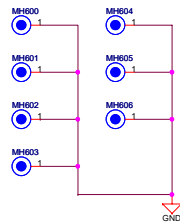
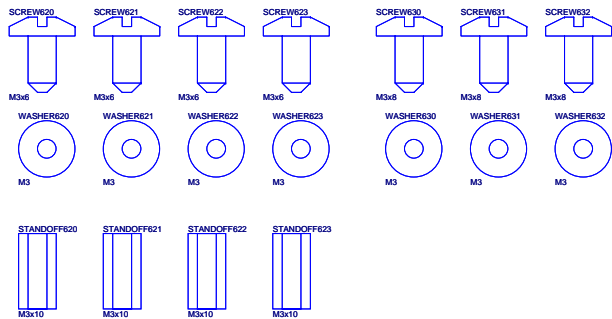

A.2 TAS5132DDV6EVM Parts List

The TAS5132DDV6EVM parts lists is appended to this page.

TAS5132DDV6EVM Parts List (2.00)



Qty	Part Reference	Description	Manufacture	First Mfr P/N
1	R901	10.0k/125mW 1% 0805 Metal Film Resistor	BC Components	DCU 0805 1% 10k0
8	R140 R141 R160 R161 R260 R261 R262 R263	470R/125mW 1% 0805 Metal Film Resistor	BC Components	DCU 0805 1% 470R
4	R112 R113 R212 R213	1.0k/100mW 5% 0603 Metal Film Resistor	BC Components	DCT 0603 5% 1k00
	R40 R41 R42 R44 R45 R46 R47 R67 R68 R69			
24	R70 R71 R72 R73 R142 R143 R162 R163 R180 R956 R980 R981 R982 R983	10k/100mW 5% 0603 Metal Film Resistor	BC Components	DCT 0603 5% 10k0
7	R114 R148 R149 R168 R169 R181 R214	100k/100mW 5% 0603 Metal Film Resistor	BC Components	DCT 0603 5% 100k
	R100 R106 R108 R109 R110 R200 R206 R208			
10	R209 R210	10R/100mW 5% 0603 Metal Film Resistor	BC Components	DCT 0603 5% 10R0
1	R18	18.0k/100mW 1% 0603 Metal Film Resistor	BC Components	DCT 0603 1% 18k0
2	R10 R11	200R/100mW 5% 0603 Metal Film Resistor	BC Components	DCT 0603 5% 200R
1	R205	22k/100mW 5% 0603 Metal Film Resistor	BC Components	DCT 0603 5% 22k0
1	R957	3.3k/100mW 5% 0603 Metal Film Resistor	BC Components	DCT 0603 5% 3k30
	R144 R145 R146 R147 R164 R165 R166 R167			
16	R232 R233 R252 R253 R900 R903 R951 R952	3.3R/100mW 5% 0603 Metal Film Resistor	BC Components	DCT 0603 5% 3R30
1	R105	39k/100mW 5% 0603 Metal Film Resistor	BC Components	DCT 0603 5% 39k0
	R24 R48 R49 R51 R52 R53 R54 R55 R60 R61			
17	R62 R63 R64 R65 R66 R111 R211	47R/100mW 5% 0603 Metal Film Resistor	BC Components	DCT 0603 5% 47R0
1	C910	Ceramic 100nF/50V 20% X7R 0805 Capacitor	BC Components	0805B104M500NT
8	C123 C125 C127 C129 C223 C225 C227 C229	Ceramic 1uF/50V 10% X7R 1206 Capacitor	TDK	C3216X7R1H105K
	C10 C13 C146 C147 C148 C149 C166 C167			
19	C168 C169 C235 C236 C255 C256 C901 C906 C953 C955 C962	Ceramic 10nF/50V 20% X7R 0603 Capacitor	BC Components	0603B103M500NT
	C11 C12 C14 C17 C21 C22 C25 C101 C102			
23	C104 C105 C106 C111 C114 C201 C202 C204 C205 C206 C211 C214 C980 C981	Ceramic 100nF/16V 20% X7R 0603 Capacitor	BC Components	0603B104M160NT
	C113 C115 C117 C119 C213 C215 C217 C219			
21	C233 C234 C253 C254 C900 C905 C908 C909 C915 C922 C923 C952 C954	Ceramic 100nF/50V 20% X7R 0603 Capacitor	Vishay	VJ0603Y104MXATW1BC
8	C107 C108 C109 C110 C207 C208 C209 C210	Ceramic 33nF/25V 20% X7R 0603 Capacitor	BC Components	0603B333M250NT
8	C150 C151 C170 C171 C237 C238 C257 C258	Ceramic 1nF/50V 10% NP0 0603 Capacitor	BC Components	0603N102K500NT
	C20 C100 C112 C180 C200 C212			
6	C20 C100 C112 C180 C200 C212	Electrolytic 10uF/16V 20% Aluminium 1.5mm ø4mm Ultra-Mini Series Capacitor	Sang Jing Electronics	UMR16V106M4X5
	C907 C912			
2	C907 C912	Electrolytic 100uF/35V 20% Aluminium 3.5mm ø8mm FC Series - Low Impedance Capacitor	Panasonic	EEUF1V101
4	C911 C913 C921 C924	Electrolytic 100uF/16V 20% Aluminium 2.5mm ø6.3mm Ultra-Mini Series Capacitor	Sang Jing Electronics	UMR16V107M6.3X5
	C140 C141 C142 C143 C160 C161 C162 C163			
10	C272 C274	Electrolytic 470uF/25V 20% Aluminium 5mm ø10mm FC Series - Low Impedance Capacitor	Panasonic	EEUF1E471
	C144 C145 C164 C165			
4	C144 C145 C164 C165	Metal Film 1uF/63V 10% Polyester 5mm (W:5.0mm L:7.2mm) Capacitor	Wima	MKS 2 1uF/10%/63Vdc PCM5
	C232 C252			
2	C232 C252	Metal Film 470nF/63V 10% Polyester 5mm (W:4.5mm L:7.2mm) Capacitor	Wima	MKS 2 0.47uF/10%/63Vdc PCM5
	L900			
1	L900	220uH/0.5A 20% (390mR) Magnetically shielded Ferrite Inductor	CoilCraft	DT3316P-224
4	L230 L231 L250 L251	10uH/Ferrite Inductor	Kwang Sung	8080B-21-100M
4	L130 L131 L150 L151	22uH/Ferrite Inductor	Kwang Sung	8080B-17-220K
1	D901	1A/40V Schottky Diode (SMA)	Int. Rectifier	10MQ040N
1	Q981	600mA/40V NPN Small signal Transistor (SOT-23)	Philips	PMBT2222
6	Q100 Q180 Q181 Q200 Q980 Q982	800mA/40V PNP Small signal Transistor (SOT-23)	Fairchild	MMBT2907A
	U10			
1	U10	6 ch PWM processor (SE, VOL, 192kHz, I2S out) (TSSOP38)	Texas Instruments	TAS5086DBT
2	U100 U200	4ch/2ch/1ch Digital Audio PWM Power Output Stage (DDV44)	Texas Instruments	TAS5132DDV
1	U908	3.3V Supply Voltage Supervisor (SOT323-5)	Texas Instruments	TPS3801K33DCK
1	U900	12V/500mA Positive Voltage Regulator (KTP)	Texas Instruments	UA78M12CKTPR
1	U907	3.3V Low Dropout Voltage Regulator (KTP)	Texas Instruments	TLV2217-33KTPR
1	U901	5V/3A Buck Converter (SO8)	Texas Instruments	TPS5430DDA
	SCREW620 SCREW621 SCREW622			
4	SCREW623	M3x6, Pan Head, Pozidriv, A2 Screw	Bossard	BN 81882 M3x6
3	SCREW630 SCREW631 SCREW632	M3x8, Pan Head, Pozidriv, A2 Screw	Bossard	BN 81882 M3x8
	WASHER620 WASHER621 WASHER622			
4	WASHER623	M3 Stainless Steel Washer	Bossard	BN 670 M3
3	WASHER630 WASHER631 WASHER632	M3 Stainless Steel Spring Washer	Bossard	BN 760 M3
	STANDOFF620 STANDOFF621			
4	STANDOFF622 STANDOFF623	M3x10 Aluminium Stand-off	Ettinger	05.03.108
6	J101 J102 J103 J104 J105 J106	2 pins/1 row/3.96mm Pitch Vertical Male Pin header	JST	B2P-VH
1	J901	4 pins/1 row/3.96mm Pitch Vertical Male Pin header	JST	B4P-VH
1	J60	16 pins/2 rows/2.54mm Pitch Vertical Male IDC	Molex	87256-1611
1	J40	34 pins/2 rows/2.54mm Pitch Vertical Male IDC	Molex	87256-3411
1	PCB610	TAS5132DDV6EVM Printed Circuit Board (ver. 2.00)	Printline	A814-PCB-001(2.00)

A.3 TAS5132DDV6EVM Specifications

The TAS5132DDV6EVM PCB specification is appended to this page.

TAS5132DDV6EVM

PCB SPECIFICATION

Version 2.00

BOARD IDENTIFICATION:	A814-PCB-001(2.00)
BOARD TYPE:	DOUBLE-SIDED PLATED-THROUGH BOARD
LAMINATE TYPE:	FR4
LAMINATE THICKNESS:	1.6mm
COPPER THICKNESS:	70 μ m (INCL. PLATING EXTERIOR LAYER)
COPPER PLATING OF HOLES:	>25 μ m
MINIMUM HOLE DIAMETER	0.3 mm
SILKSCREEN COMPONENT SIDE:	WHITE - REMOVE SILKSCREEN FROM SOLDER AREA & PRE-TINNED AREAS
SILKSCREEN SOLDER SIDE:	None
SOLDER MASK COMPONENT SIDE:	GREEN
SOLDER MASK SOLDER SIDE:	GREEN
PROTECTIVE COATING:	SOLDER COATING AND CHEMICAL SILVER ON FREE COPPER
ELECTRICAL TEST:	PCB MUST BE ELECTRICAL TESTED
MANUFACTURED TO:	PERFAG 2E (www.perfag.dk)
APERTURE TABLE:	PERFAG 10A (www.perfag.dk)
BOARD SIZE:	112 x 154 mm
COMMENTS:	SEE DRILL INFORMATION FILE (5209pcb.PDF).

A.4 TAS5132DDV6EVM PCB Layers

The PCB layers are appended to this page.

COMPONENT SIDE	DpS 5209 070110
TI Denmark A814-PCB-001 (2.00)	

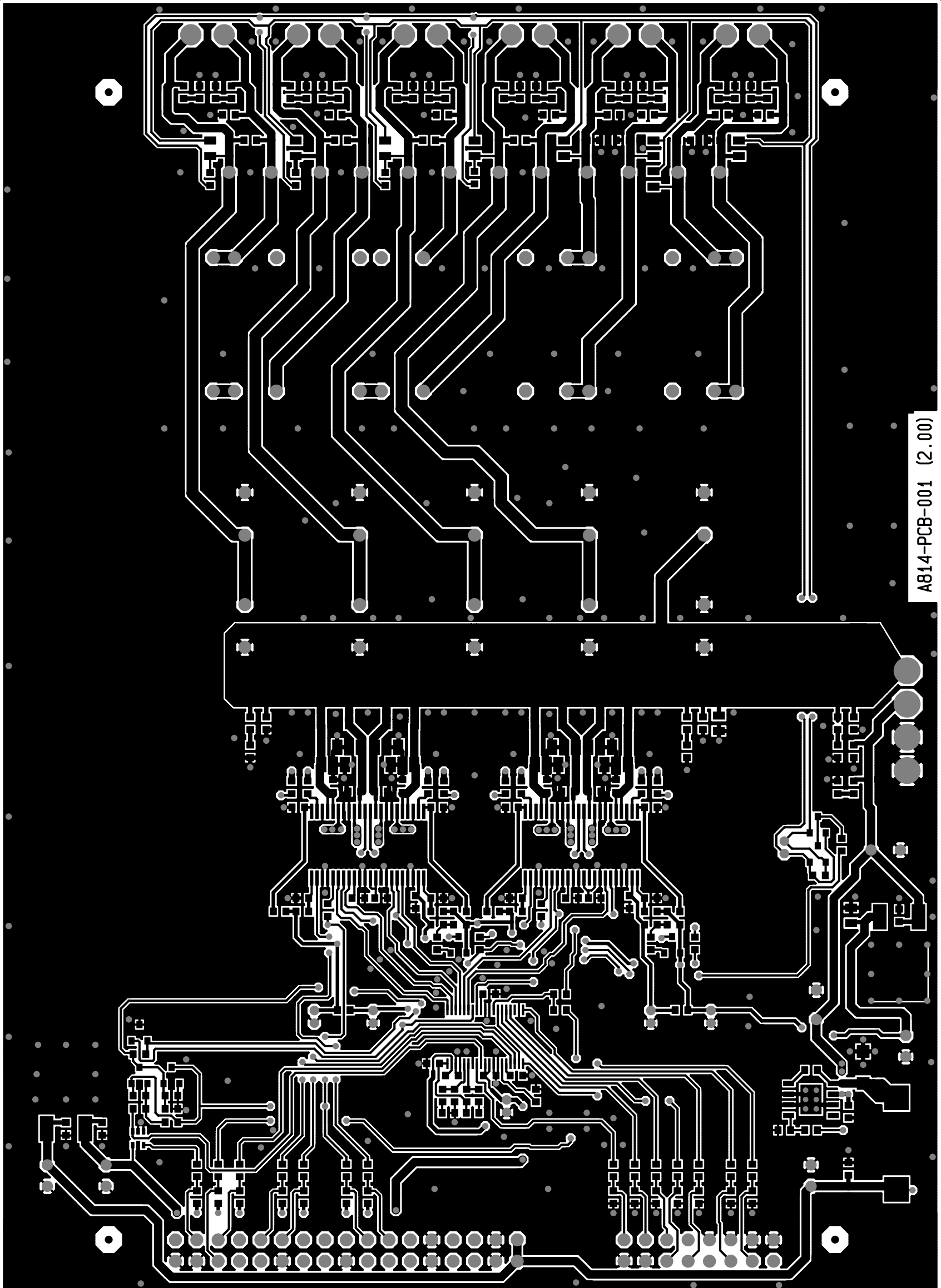

A814-PCB-001 (2.00)

SILKSCREEN COMP	Dps 5209 070110
TI Denmark A814-PCB-001 (2.00)	

SUBWOOFER J106 R252 R253 R254 R255 R256 R257 R258
CENTER J105 R232 R233 R234 R235 R236 R237 R238
REAR RIGHT J104 R165 R166 R167 R168 R169 R170 R171
LEFT RIGHT J103 R146 R147 R148 R149 R150 R151 R152
FRONT RIGHT J102 R144 R145 R146 R147 R148 R149 R150
FRONT LEFT J101 R144 R145 R146 R147 R148 R149 R150

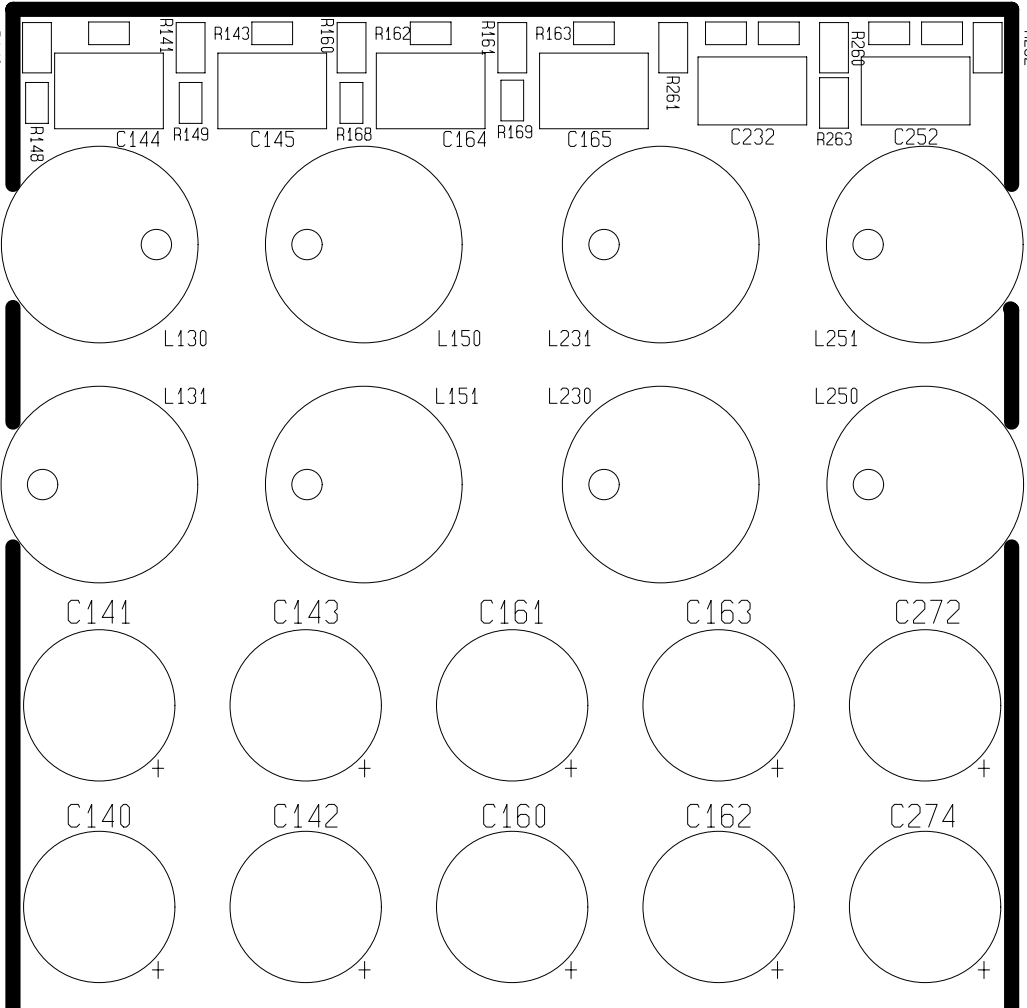

REV [Redacted]
N/S [Redacted]

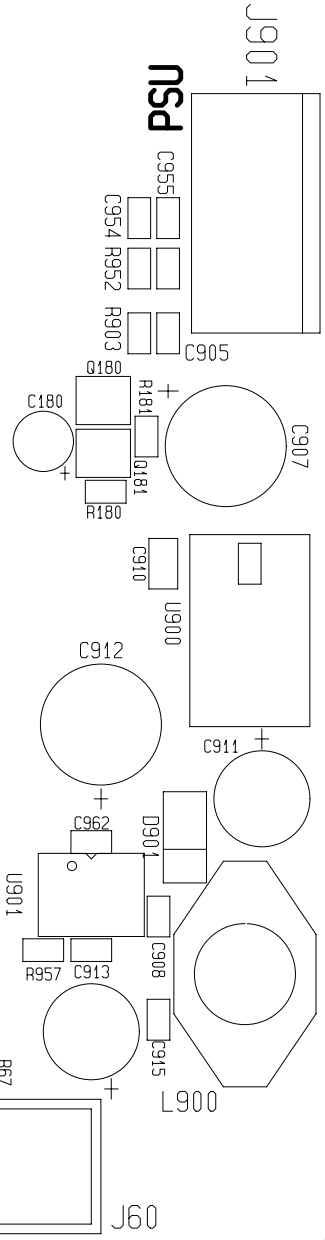

TEXAS INSTRUMENTS
 TAS5132DDV6EVM
PUREPATH DIGITAL
5.1 CH AMPLIFIER

A814-PCB-001 (2.00)
 All rights reserved
 Patents Pending

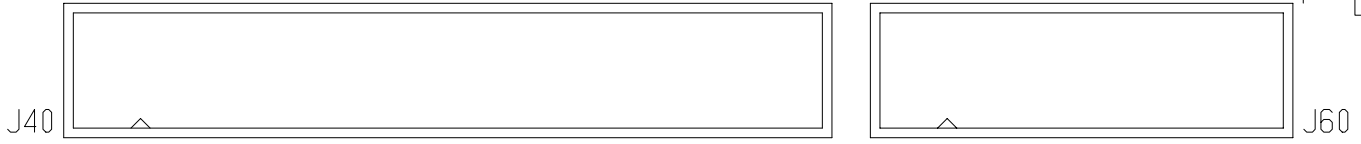
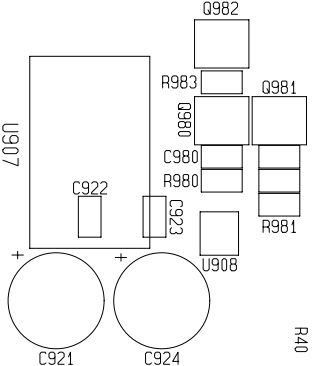

COMP. LAYOUT COMP | DpS 5209 070110
 TI Denmark A814-PCB-001 (2.00)

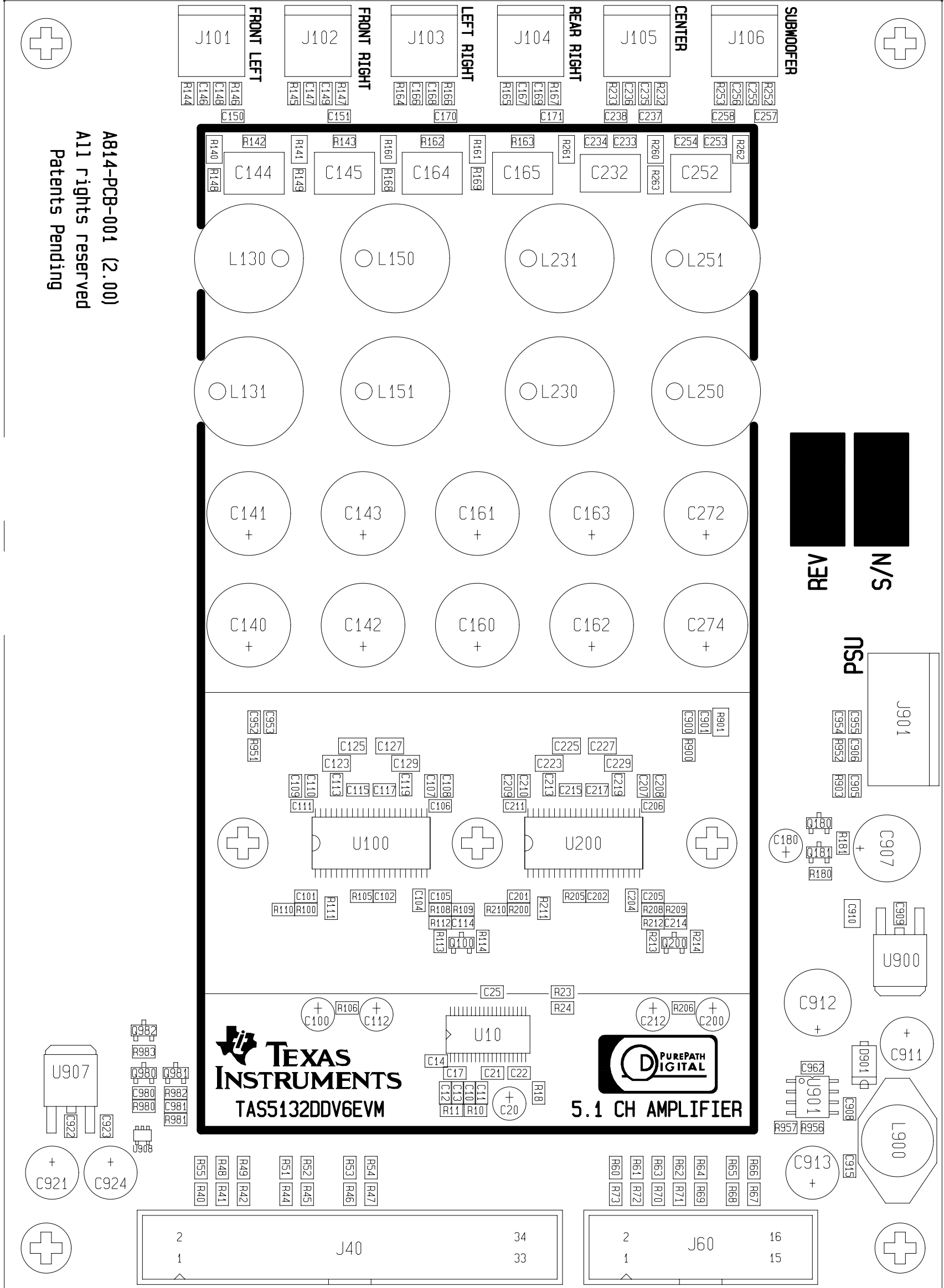

A814-PCB-001 (2.00)
 All rights reserved
 Patents Pending

REV N/S

PSU

TEXAS INSTRUMENTS
 TAS5132DDV6EVM

PUREPATH DIGITAL
 5.1 CH AMPLIFIER



COMP/PCB LAYOUTS ICOMP	DpS 5209 070110
TI Denmark A814-PCB-001 (2.00)	

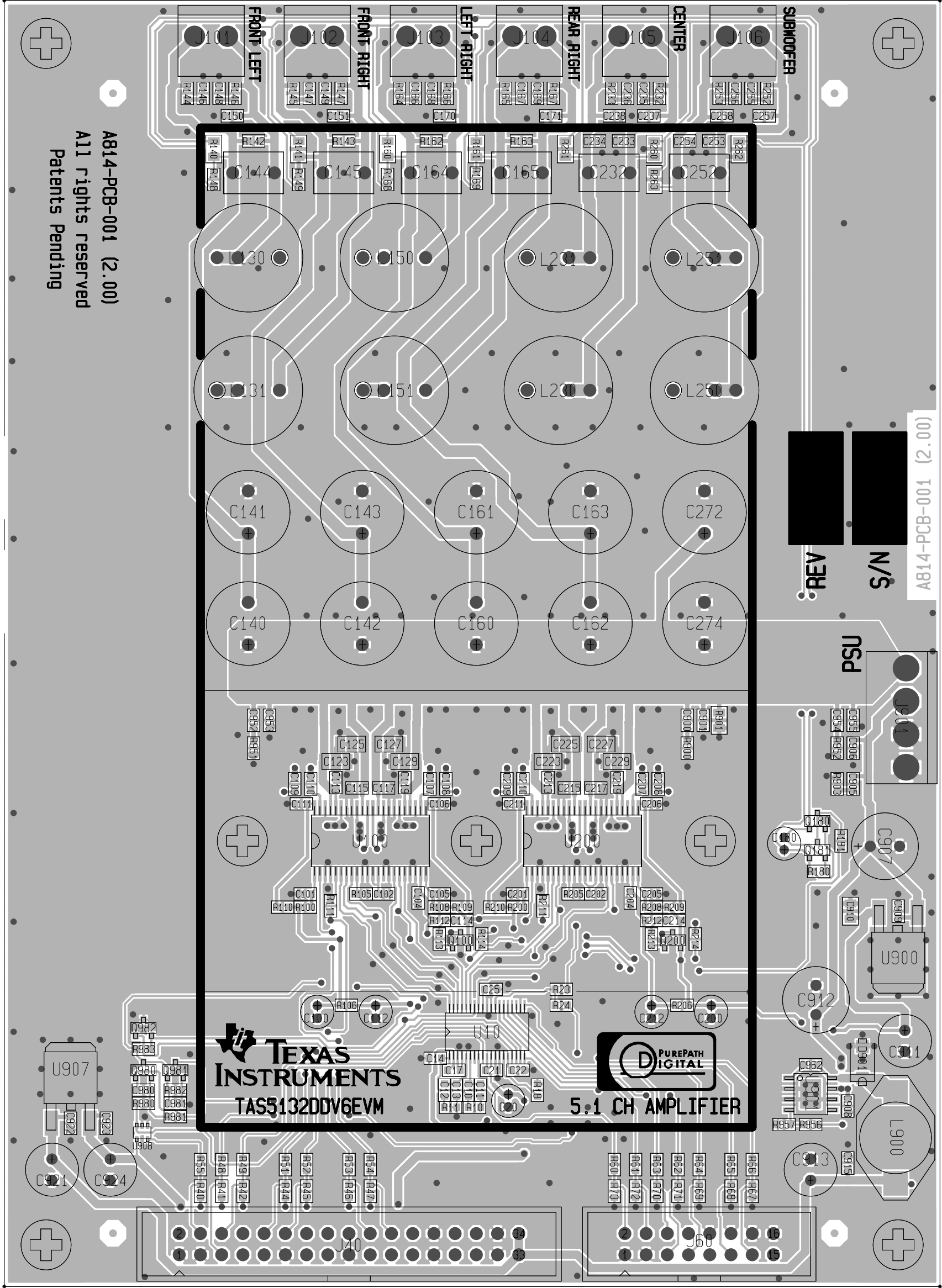

INNERLAYER NO :	Dps 5209 070110
TI Denmark A814-PCB-001 (2.00)	

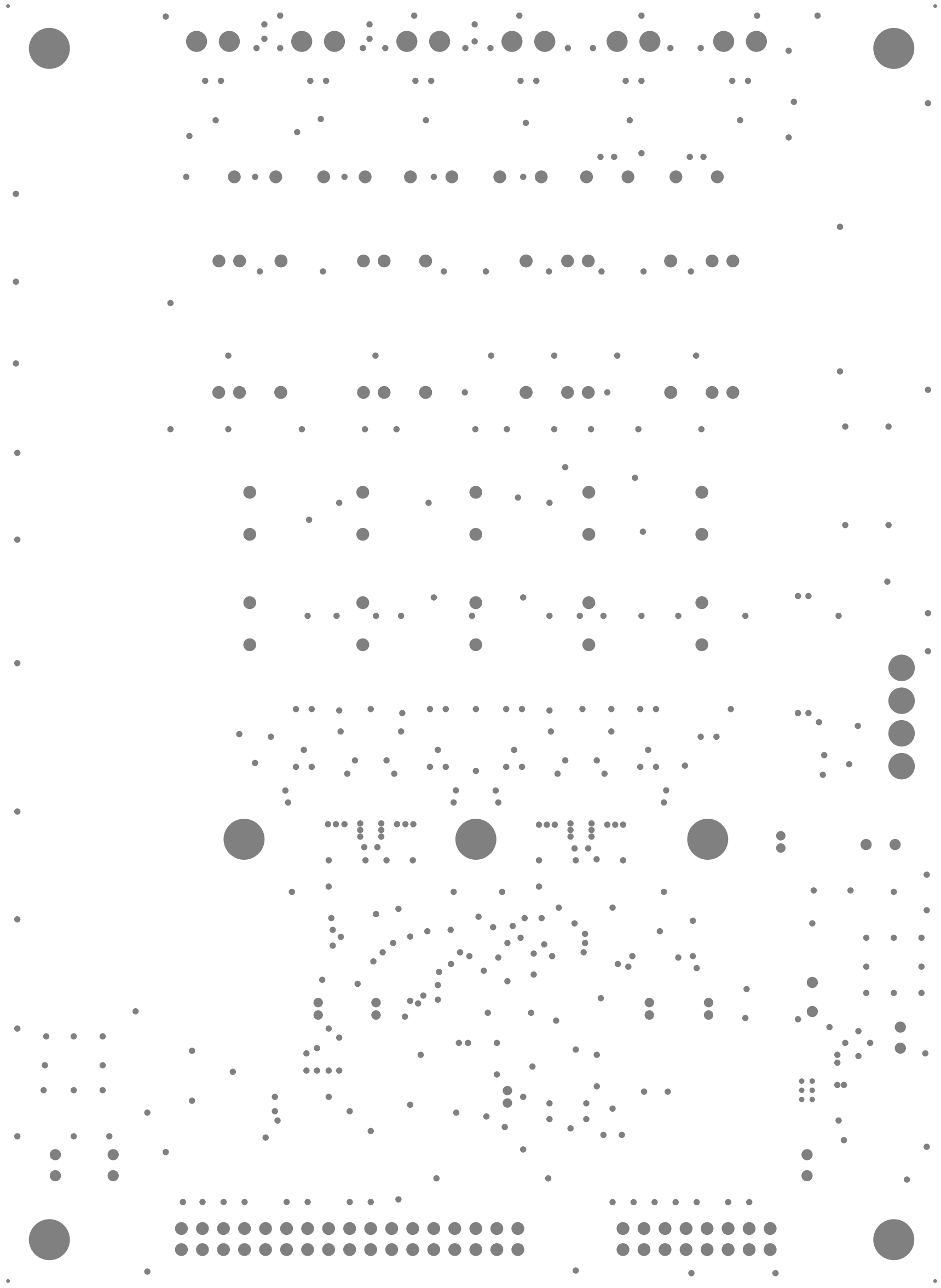

EVALUATION BOARD/KIT IMPORTANT NOTICE

Texas Instruments (TI) provides the enclosed product(s) under the following conditions:

This evaluation board/kit is intended for use for **ENGINEERING DEVELOPMENT, DEMONSTRATION, OR EVALUATION PURPOSES ONLY** and is not considered by TI to be a finished end-product fit for general consumer use. Persons handling the product(s) must have electronics training and observe good engineering practice standards. As such, the goods being provided are not intended to be complete in terms of required design-, marketing-, and/or manufacturing-related protective considerations, including product safety and environmental measures typically found in end products that incorporate such semiconductor components or circuit boards. This evaluation board/kit does not fall within the scope of the European Union directives regarding electromagnetic compatibility, restricted substances (RoHS), recycling (WEEE), FCC, CE or UL, and therefore may not meet the technical requirements of these directives or other related directives.

Should this evaluation board/kit not meet the specifications indicated in the User's Guide, the board/kit may be returned within 30 days from the date of delivery for a full refund. **THE FOREGOING WARRANTY IS THE EXCLUSIVE WARRANTY MADE BY SELLER TO BUYER AND IS IN LIEU OF ALL OTHER WARRANTIES, EXPRESSED, IMPLIED, OR STATUTORY, INCLUDING ANY WARRANTY OF MERCHANTABILITY OR FITNESS FOR ANY PARTICULAR PURPOSE.**

The user assumes all responsibility and liability for proper and safe handling of the goods. Further, the user indemnifies TI from all claims arising from the handling or use of the goods. Due to the open construction of the product, it is the user's responsibility to take any and all appropriate precautions with regard to electrostatic discharge.

EXCEPT TO THE EXTENT OF THE INDEMNITY SET FORTH ABOVE, NEITHER PARTY SHALL BE LIABLE TO THE OTHER FOR ANY INDIRECT, SPECIAL, INCIDENTAL, OR CONSEQUENTIAL DAMAGES.

TI currently deals with a variety of customers for products, and therefore our arrangement with the user **is not exclusive.**

TI assumes **no liability for applications assistance, customer product design, software performance, or infringement of patents or services described herein.**

Please read the User's Guide and, specifically, the Warnings and Restrictions notice in the User's Guide prior to handling the product. This notice contains important safety information about temperatures and voltages. For additional information on TI's environmental and/or safety programs, please contact the TI application engineer or visit www.ti.com/esh.

No license is granted under any patent right or other intellectual property right of TI covering or relating to any machine, process, or combination in which such TI products or services might be or are used.

FCC Warning

This evaluation board/kit is intended for use for **ENGINEERING DEVELOPMENT, DEMONSTRATION, OR EVALUATION PURPOSES ONLY** and is not considered by TI to be a finished end-product fit for general consumer use. It generates, uses, and can radiate radio frequency energy and has not been tested for compliance with the limits of computing devices pursuant to part 15 of FCC rules, which are designed to provide reasonable protection against radio frequency interference. Operation of this equipment in other environments may cause interference with radio communications, in which case the user at his own expense will be required to take whatever measures may be required to correct this interference.

EVM WARNINGS AND RESTRICTIONS

It is important to operate this EVM within the input voltage range of 15 V to 20 V and the output voltage range of 0 V to 18 V.

Exceeding the specified input range may cause unexpected operation and/or irreversible damage to the EVM. If there are questions concerning the input range, please contact a TI field representative prior to connecting the input power.

Applying loads outside of the specified output range may result in unintended operation and/or possible permanent damage to the EVM. Please consult the EVM User's Guide prior to connecting any load to the EVM output. If there is uncertainty as to the load specification, please contact a TI field representative.

During normal operation, some circuit components may have case temperatures greater than 75°C. The EVM is designed to operate properly with certain components above 75°C as long as the input and output ranges are maintained. These components include but are not limited to linear regulators, switching transistors, pass transistors, and current sense resistors. These types of devices can be identified using the EVM schematic located in the EVM User's Guide. When placing measurement probes near these devices during operation, please be aware that these devices may be very warm to the touch.

Mailing Address: Texas Instruments, Post Office Box 655303, Dallas, Texas 75265
Copyright © 2007, Texas Instruments Incorporated

EVALUATION BOARD/KIT IMPORTANT NOTICE

Texas Instruments (TI) provides the enclosed product(s) under the following conditions:

This evaluation board/kit is intended for use for **ENGINEERING DEVELOPMENT, DEMONSTRATION, OR EVALUATION PURPOSES ONLY** and is not considered by TI to be a finished end-product fit for general consumer use. Persons handling the product(s) must have electronics training and observe good engineering practice standards. As such, the goods being provided are not intended to be complete in terms of required design-, marketing-, and/or manufacturing-related protective considerations, including product safety and environmental measures typically found in end products that incorporate such semiconductor components or circuit boards. This evaluation board/kit does not fall within the scope of the European Union directives regarding electromagnetic compatibility, restricted substances (RoHS), recycling (WEEE), FCC, CE or UL, and therefore may not meet the technical requirements of these directives or other related directives.

Should this evaluation board/kit not meet the specifications indicated in the User's Guide, the board/kit may be returned within 30 days from the date of delivery for a full refund. **THE FOREGOING WARRANTY IS THE EXCLUSIVE WARRANTY MADE BY SELLER TO BUYER AND IS IN LIEU OF ALL OTHER WARRANTIES, EXPRESSED, IMPLIED, OR STATUTORY, INCLUDING ANY WARRANTY OF MERCHANTABILITY OR FITNESS FOR ANY PARTICULAR PURPOSE.**

The user assumes all responsibility and liability for proper and safe handling of the goods. Further, the user indemnifies TI from all claims arising from the handling or use of the goods. Due to the open construction of the product, it is the user's responsibility to take any and all appropriate precautions with regard to electrostatic discharge.

EXCEPT TO THE EXTENT OF THE INDEMNITY SET FORTH ABOVE, NEITHER PARTY SHALL BE LIABLE TO THE OTHER FOR ANY INDIRECT, SPECIAL, INCIDENTAL, OR CONSEQUENTIAL DAMAGES.

TI currently deals with a variety of customers for products, and therefore our arrangement with the user **is not exclusive.**

TI assumes **no liability for applications assistance, customer product design, software performance, or infringement of patents or services described herein.**

Please read the User's Guide and, specifically, the Warnings and Restrictions notice in the User's Guide prior to handling the product. This notice contains important safety information about temperatures and voltages. For additional information on TI's environmental and/or safety programs, please contact the TI application engineer or visit www.ti.com/esh.

No license is granted under any patent right or other intellectual property right of TI covering or relating to any machine, process, or combination in which such TI products or services might be or are used.

FCC Warning

This evaluation board/kit is intended for use for **ENGINEERING DEVELOPMENT, DEMONSTRATION, OR EVALUATION PURPOSES ONLY** and is not considered by TI to be a finished end-product fit for general consumer use. It generates, uses, and can radiate radio frequency energy and has not been tested for compliance with the limits of computing devices pursuant to part 15 of FCC rules, which are designed to provide reasonable protection against radio frequency interference. Operation of this equipment in other environments may cause interference with radio communications, in which case the user at his own expense will be required to take whatever measures may be required to correct this interference.

EVM WARNINGS AND RESTRICTIONS

It is important to operate this EVM within the input voltage range of 15 V to 20 V and the output voltage range of 0 V to 18 V.

Exceeding the specified input range may cause unexpected operation and/or irreversible damage to the EVM. If there are questions concerning the input range, please contact a TI field representative prior to connecting the input power.

Applying loads outside of the specified output range may result in unintended operation and/or possible permanent damage to the EVM. Please consult the EVM User's Guide prior to connecting any load to the EVM output. If there is uncertainty as to the load specification, please contact a TI field representative.

During normal operation, some circuit components may have case temperatures greater than 75°C. The EVM is designed to operate properly with certain components above 75°C as long as the input and output ranges are maintained. These components include but are not limited to linear regulators, switching transistors, pass transistors, and current sense resistors. These types of devices can be identified using the EVM schematic located in the EVM User's Guide. When placing measurement probes near these devices during operation, please be aware that these devices may be very warm to the touch.

Mailing Address: Texas Instruments, Post Office Box 655303, Dallas, Texas 75265
Copyright © 2007, Texas Instruments Incorporated