

Micropower dual CMOS voltage comparators

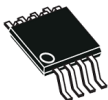

**D
SO8**
(plastic micropackage)



**P
TSSOP8**
(thin shrink small outline package)



**S
MiniSO8**
(plastic package)



DFN8 2x2 mm
(plastic micropackage)

Product status link

[TSX3702](#)

Related products

See [TSX393](#)

for open drain
output products

Features

- Low supply current: 5 μ A typ. per comparator
- Wide single supply range 2.7 V to 16 V or dual supplies (± 1.35 V to ± 8 V)
- Extremely low input bias current: 1 pA typ.
- Input common-mode voltage range includes ground
- Push-pull output
- High input impedance: 10^{12} Ω typ
- Fast response time: 2.7 μ s typ. for 5 mV overdrive
- ESD tolerance: 4 kV HBM, 200 V MM

Applications

- Automotive
- Industrial

Description

The [TSX3702](#) is a micropower CMOS dual voltage comparator which exhibits a very low current consumption of 5 μ A typical per comparator. This device was designed as the improvement of the TS3702: it shows a lower current consumption, a better input offset voltage, and an enhanced ESD tolerance. The [TSX3702](#) is fully specified over a wide temperature range and is proposed in automotive grade for the SO8 package. It is fully compatible with the TS3702 CMOS comparator and is available with similar packages. New tiny packages (MiniSO8 and DFN8 2x2 mm) are also proposed for the [TSX3702](#) thus allowing even more integration on applications.

1 Package pin connections

Figure 1. Pin connections top view

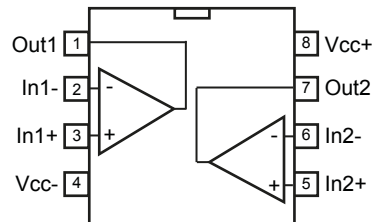

2 Absolute maximum ratings

Table 1. Absolute maximum ratings (AMR)

Symbol	Parameter	Value	Unit	
V_{CC}^+	Supply voltage ⁽¹⁾	18	V	
V_{id}	Differential input voltage ⁽²⁾	±18		
V_{in}	Input voltage	-0.3 to 18		
V_o	Output voltage	18		
I_o	Output current	20	mA	
I_F	Forward current in ESD protection diodes on inputs ⁽³⁾	50		
T_j	Maximum junction temperature	150	°C	
R_{thja}	Thermal resistance junction to ambient ⁽⁴⁾	SO8	125	°C/W
		TSSOP8	120	
		MiniSO8	190	
		DFN8 2x2	57	
T_{stg}	Storage temperature range	-65 to 150	°C	
ESD	HBM: human body model ⁽⁵⁾	4000	V	
	MM: machine model ⁽⁶⁾	200		
	CDM: charged device model ⁽⁷⁾	1500		
	Latch-up immunity	200	mA	

1. All voltage values, except differential voltage, are with respect to network ground terminal.
2. Differential voltages are the non-inverting input terminal with respect to the inverting input terminal.
3. Guaranteed by design
4. Short-circuits can cause excessive heating and destructive dissipation. Values are typical.
5. According to JEDEC standard JESD22-A114F
6. According to JEDEC standard JESD22-A115A
7. According to ANSI/ESD STM5.3.1

3 Operating conditions

Table 2. Operating conditions

Symbol	Parameter	Value	Unit
V_{CC}^+	Supply voltage	2.7 to 16	V
$V_{icm}^{(1)}$	Common mode input voltage range	0 to $V_{CC}^+ - 1.5$	
	$T_{min} \leq T_{amb} \leq T_{max}$	0 to $V_{CC}^+ - 2$	
T_{oper}	Operating free-air temperature range	-40 to 125	°C

1. The output state is guaranteed as long as one input remains with this common mode input voltage range, and the other input remains between -0.3 V and 16 V (meaning that one input can be driven above V_{CC}^+).

4 Schematic diagram

Figure 2. Schematic diagram (one operator)

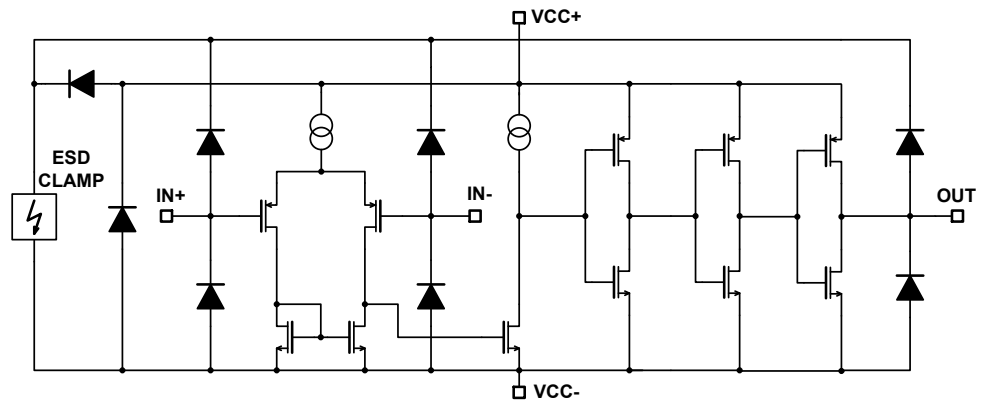

5 Electrical characteristics

Table 3. $V_{CC}^+ = 3\text{ V}$, $V_{CC}^- = 0\text{ V}$, $T_{\text{amb}} = 25\text{ }^\circ\text{C}$ (unless otherwise specified)

Symbol	Parameter	Conditions	Min.	Typ.	Max.	Unit
V_{io}	Input offset voltage ⁽¹⁾	$V_{icm} = 0\text{ V}$	-5	0.1	5	mV
		$T_{\text{min}} \leq T_{\text{amb}} \leq T_{\text{max}}$	-6		6	
I_{io}	Input offset current ⁽²⁾	$V_{icm} = V_{CC}/2$		1	10	pA
		$T_{\text{min}} \leq T_{\text{amb}} \leq T_{\text{max}}$			600	
I_{ib}	Input bias current ⁽²⁾	$V_{icm} = V_{CC}/2$		1	10	
		$T_{\text{min}} \leq T_{\text{amb}} \leq T_{\text{max}}$			1200	
CMR	Common-mode rejection ratio	$V_{icm} = 0\text{ to max } V_{icm}$	58	73		dB
		$T_{\text{min}} \leq T_{\text{amb}} \leq T_{\text{max}}$	55			
SVR	Supply voltage rejection ratio	$V_{CC}^+ = 3\text{ V to } 5\text{ V}$, $V_{icm} = V_{CC}/2$	69	88		
		$T_{\text{min}} \leq T_{\text{amb}} \leq T_{\text{max}}$	69			
V_{OH}	High-level output voltage drop	$V_{id} = 1\text{ V}$, $I_{OH} = 4\text{ mA}$		300	400	mV
		$T_{\text{min}} \leq T_{\text{amb}} \leq T_{\text{max}}$			600	
V_{OL}	Low-level output voltage	$V_{id} = -1\text{ V}$, $I_{OL} = 4\text{ mA}$		300	400	mV
		$T_{\text{min}} \leq T_{\text{amb}} \leq T_{\text{max}}$			600	
I_{CC}	Supply current per comparator	No load, outputs low		5	6	μA
		$T_{\text{min}} \leq T_{\text{amb}} \leq T_{\text{max}}$			7	
		No load, outputs high		8	9	
		$T_{\text{min}} \leq T_{\text{amb}} \leq T_{\text{max}}$			11	
t_{PLH}	Response time low to high	$V_{icm} = 0\text{ V}$, $f = 10\text{ kHz}$, $R_L = 5.1\text{ k}\Omega$, $C_L = 50\text{ pF}$, overdrive = 5 mV		2.4		μs
		Overdrive = 100 mV		0.5	0.6	
		$T_{\text{min}} \leq T_{\text{amb}} \leq T_{\text{max}}$			0.77	
t_{PHL}	Response time high to low	$V_{icm} = 0\text{ V}$, $f = 10\text{ kHz}$, $R_L = 5.1\text{ k}\Omega$, $C_L = 50\text{ pF}$, overdrive = 5 mV		2.0		μs
		Overdrive = 100 mV		0.45	0.6	
		$T_{\text{min}} \leq T_{\text{amb}} \leq T_{\text{max}}$			0.65	
t_r	Rise time	$f = 10\text{ kHz}$, $C_L = 50\text{ pF}$, $R_L = 5.1\text{ k}\Omega$, overdrive 50 mV		39		ns
t_f	Fall time	$f = 10\text{ kHz}$, $C_L = 50\text{ pF}$, $R_L = 5.1\text{ k}\Omega$, overdrive 50 mV		39		

1. The specified offset voltage is the maximum value required to drive the output up to 2.5 V or down to 0.3 V.
2. Guaranteed by design

Table 4. $V_{CC}^+ = 5\text{ V}$, $V_{CC}^- = 0\text{ V}$, $T_{amb} = 25\text{ °C}$ (unless otherwise specified)

Symbol	Parameter	Conditions	Min.	Typ.	Max.	Unit
V_{io}	Input offset voltage ⁽¹⁾	$V_{icm} = V_{CC}/2$	-5	0.1	5	mV
		$T_{min} \leq T_{amb} \leq T_{max}$	-6		6	
I_{io}	Input offset current ⁽²⁾	$V_{icm} = V_{CC}/2$		1	10	pA
		$T_{min} \leq T_{amb} \leq T_{max}$			600	
I_{ib}	Input bias current ⁽²⁾	$V_{icm} = V_{CC}/2$		1	10	pA
		$T_{min} \leq T_{amb} \leq T_{max}$			1200	
CMR	Common-mode rejection ratio	$V_{icm} = 0$ to max V_{icm}	66	85		dB
		$T_{min} \leq T_{amb} \leq T_{max}$	65			
SVR	Supply voltage rejection ratio	$V_{CC}^+ = 5\text{ V}$ to 10 V, $V_{icm} = V_{CC}/2$	71	89		dB
		$T_{min} \leq T_{amb} \leq T_{max}$	70			
V_{OH}	High-level output voltage drop	$V_{id} = 1\text{ V}$, $I_{OH} = 4\text{ mA}$		180	250	mV
		$T_{min} \leq T_{amb} \leq T_{max}$			400	
V_{OL}	Low-level output voltage	$V_{id} = -1\text{ V}$, $I_{OL} = 4\text{ mA}$		180	250	mV
		$T_{min} \leq T_{amb} \leq T_{max}$			400	
I_{CC}	Supply current per comparator	No load, outputs low		5	8	μA
		$T_{min} \leq T_{amb} \leq T_{max}$			9	
		No load, outputs high		9	10	
		$T_{min} \leq T_{amb} \leq T_{max}$			11	
t_{PLH}	Response time low to high	$V_{icm} = 0\text{ V}$, $f = 10\text{ kHz}$, $R_L = 5.1\text{ k}\Omega$, $C_L = 50\text{ pF}$, overdrive = 5 mV		2.4		μs
		Overdrive = 10 mV		1.5		
		Overdrive = 20 mV		0.9		
		Overdrive = 40 mV		0.6		
		Overdrive = 100 mV		0.35	0.55	
		$T_{min} \leq T_{amb} \leq T_{max}$			0.6	
		TTL input ⁽³⁾		0.45	0.6	
t_{PHL}	Response time high to low	$V_{icm} = 0\text{ V}$, $f = 10\text{ kHz}$, $R_L = 5.1\text{ k}\Omega$, $C_L = 50\text{ pF}$, overdrive = 5 mV		2.8		μs
		Overdrive = 10 mV		1.8		
		Overdrive = 20 mV		1.0		
		Overdrive = 40 mV		0.7		
		Overdrive = 100 mV		0.46	0.6	
		$T_{min} \leq T_{amb} \leq T_{max}$			0.7	
		TTL input ⁽³⁾		0.30	0.40	
	$T_{min} \leq T_{amb} \leq T_{max}$			0.50		

Symbol	Parameter	Conditions	Min.	Typ.	Max.	Unit
t_r	Rise time	$f = 10 \text{ kHz}$, $C_L = 50 \text{ pF}$, $R_L = 5.1 \text{ k}\Omega$, overdrive 50 mV		30		ns
t_f	Fall time	$f = 10 \text{ kHz}$, $C_L = 50 \text{ pF}$, $R_L = 5.1 \text{ k}\Omega$, overdrive 50 mV		30		

1. The specified offset voltage is the maximum value required to drive the output up to 4.5 V or down to 0.3 V.
2. Guaranteed by design
3. A step from 0 V to 3 V is applied on one input while the other is fixed at 1.4 V. Response time is the time interval between the application of the input voltage step and the moment the output voltage reaches 50 % of its final value.

Table 5. $V_{CC}^+ = 16\text{ V}$, $V_{CC}^- = 0\text{ V}$, $T_{amb} = 25\text{ °C}$ (unless otherwise specified)

Symbol	Parameter	Conditions	Min.	Typ.	Max.	Unit
V_{io}	Input offset voltage ⁽¹⁾	$V_{icm} = V_{CC}/2$	-5	0.1	5	mV
		$T_{min} \leq T_{amb} \leq T_{max}$	-6		6	
I_{io}	Input offset current ⁽²⁾	$V_{icm} = V_{CC}/2$		1	10	pA
		$T_{min} \leq T_{amb} \leq T_{max}$			600	
I_{ib}	Input bias current ⁽²⁾	$V_{icm} = V_{CC}/2$		1	10	pA
		$T_{min} \leq T_{amb} \leq T_{max}$			1200	
CMR	Common-mode rejection ratio	$V_{icm} = 0$ to max V_{icm}	72	90		dB
		$T_{min} \leq T_{amb} \leq T_{max}$	70			
SVR	Supply voltage rejection ratio	$V_{CC}^+ = 5\text{ V}$ to 16 V , $V_{icm} = V_{CC}/2$	73	90		dB
		$T_{min} \leq T_{amb} \leq T_{max}$	72			
V_{OH}	High-level output voltage drop	$V_{id} = 1\text{ V}$, $I_{OH} = 4\text{ mA}$		90	150	mV
		$T_{min} \leq T_{amb} \leq T_{max}$			250	
V_{OL}	Low-level output voltage	$V_{id} = -1\text{ V}$, $I_{OL} = 4\text{ mA}$		90	150	mV
		$T_{min} \leq T_{amb} \leq T_{max}$			250	
I_{CC}	Supply current per comparator	No load, outputs low		7	9	μA
		$T_{min} \leq T_{amb} \leq T_{max}$			10	
		No load, outputs high		11	13	
		$T_{min} \leq T_{amb} \leq T_{max}$			14	
t_{PLH}	Response time low to high	$V_{icm} = 0\text{ V}$, $f = 10\text{ kHz}$, $R_L = 5.1\text{ k}\Omega$, $C_L = 50\text{ pF}$, overdrive = 5 mV		2.2		μs
		Overdrive = 10 mV		1.4		
		Overdrive = 20 mV		0.9		
		Overdrive = 40 mV		0.6		
		Overdrive = 100 mV		0.34	0.55	
		$T_{min} \leq T_{amb} \leq T_{max}$			0.60	
t_{PHL}	Response time high to low	$V_{icm} = 0\text{ V}$, $f = 10\text{ kHz}$, $R_L = 5.1\text{ k}\Omega$, $C_L = 50\text{ pF}$, overdrive = 5 mV		2.4		μs
		Overdrive = 10 mV		1.6		
		Overdrive = 20 mV		1.0		
		Overdrive = 40 mV		0.7		
		Overdrive = 100 mV		0.55	0.70	
		$T_{min} \leq T_{amb} \leq T_{max}$			0.75	
t_r	Rise time	$f = 10\text{ kHz}$, $C_L = 50\text{ pF}$, $R_L = 5.1\text{ k}\Omega$, overdrive 50 mV		11		ns
t_f	Fall time	$f = 10\text{ kHz}$, $C_L = 50\text{ pF}$, $R_L = 5.1\text{ k}\Omega$, overdrive 50 mV		11		

1. The specified offset voltage is the maximum value required to drive the output up to 4.5 V or down to 0.3 V .

2. Guaranteed by design

Figure 3. Current consumption vs. supply voltage, output high

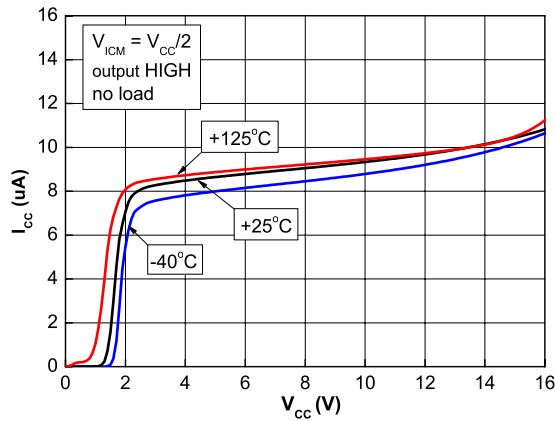

Figure 4. Current consumption vs. supply voltage, output low

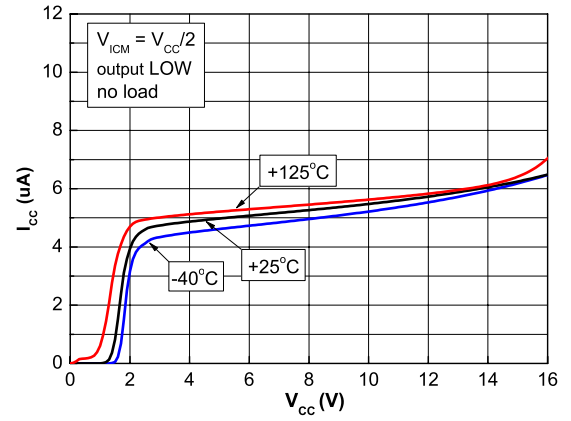

Figure 5. Current consumption vs. input common-mode voltage, output high

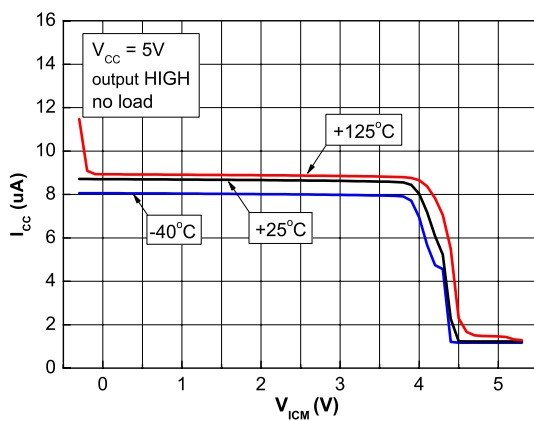

Figure 6. Current consumption vs. common-mode voltage, output low

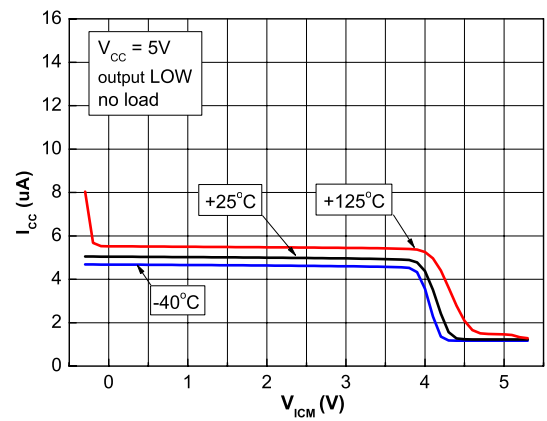

Figure 7. Output voltage drop vs. output source current, $V_{CC} = 5\text{ V}$

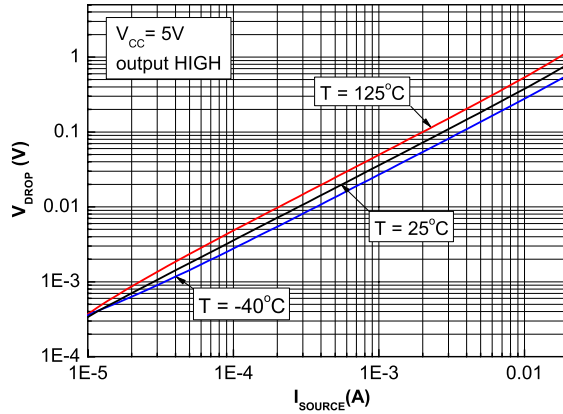

Figure 8. Output voltage drop vs. output source current, $V_{CC} = 12\text{ V}$

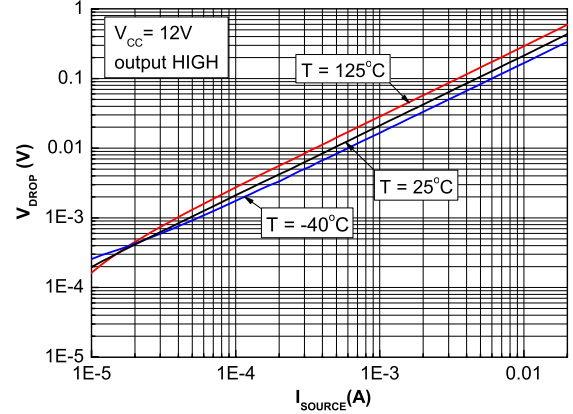

Figure 9. Output voltage drop vs. output sink current, $V_{CC} = 5\text{ V}$

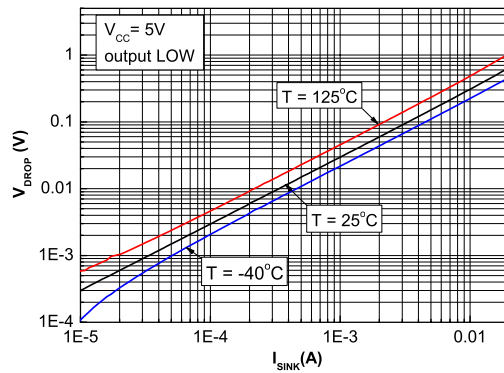
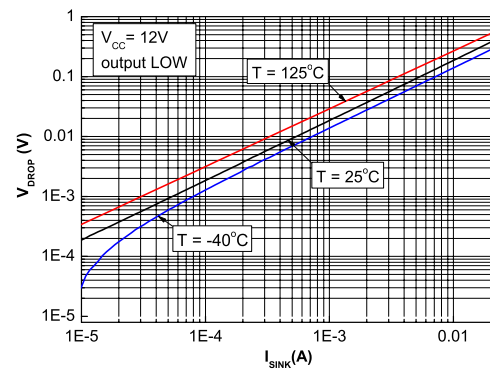

Figure 10. Output voltage drop vs. output sink current, $V_{CC} = 12\text{ V}$



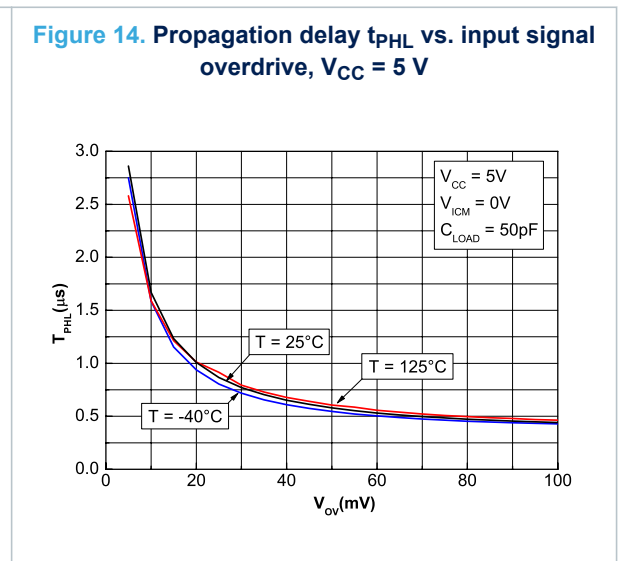
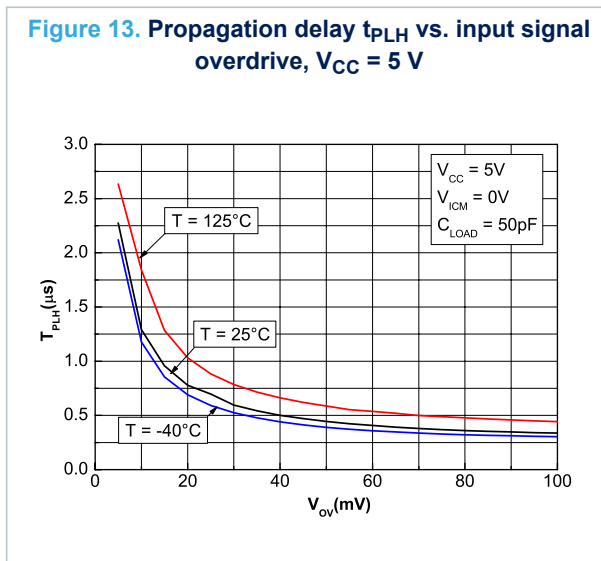
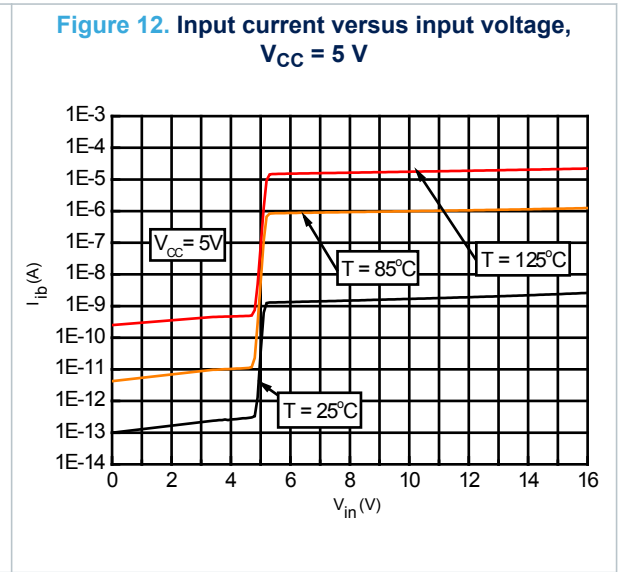
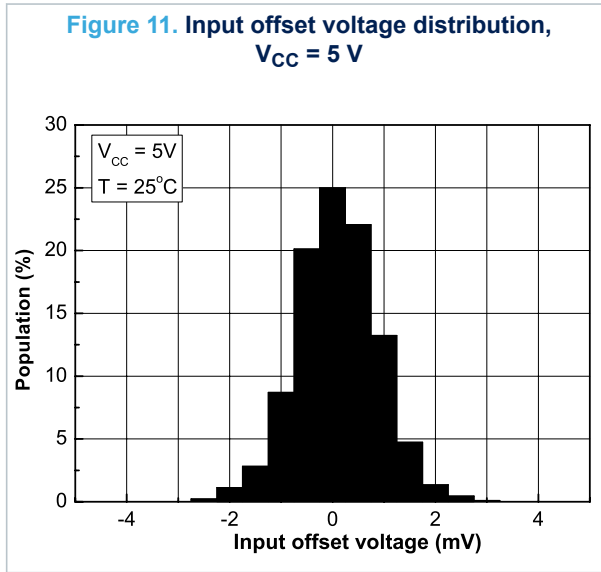

Figure 15. Propagation delay t_{PLH} vs. supply voltage, $V_{CC} = 5\text{ V}$

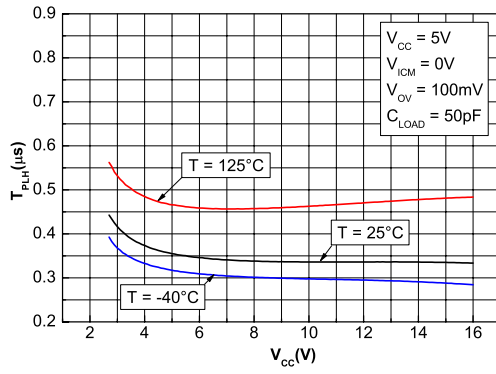
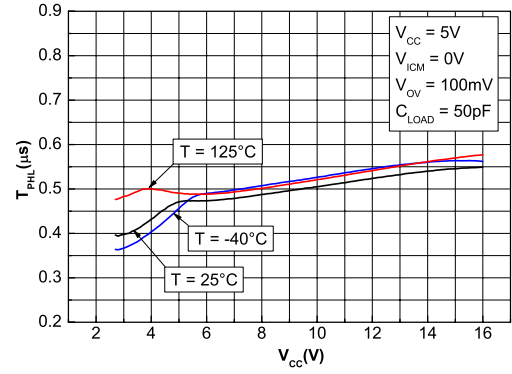

Figure 16. Propagation delay t_{PHL} vs. supply voltage, $V_{CC} = 5\text{ V}$



6 Application information (input voltages)

The ESD strategy used in the TSX3702 (and shown in [Figure 3. Schematic diagram \(one operator\)](#)) allows input voltages from -0.3 V up to 16 V to be applied regardless of the V_{CC+} voltage. When $V_{IN} > V_{CC+}$ a leakage current goes from the input through the protection diode to the ESD clamp. This current is about 0.2 nA at 25 °C and about 250 nA at 125 °C. For a detailed input characteristic see [Section 5 Figure 12](#). The device is designed to prevent phase reversal.

7 Package information

In order to meet environmental requirements, ST offers these devices in different grades of **ECOPACK** packages, depending on their level of environmental compliance. ECOPACK specifications, grade definitions and product status are available at: www.st.com. ECOPACK is an ST trademark.

7.1 SO8 package information

Figure 17. SO8 package outline

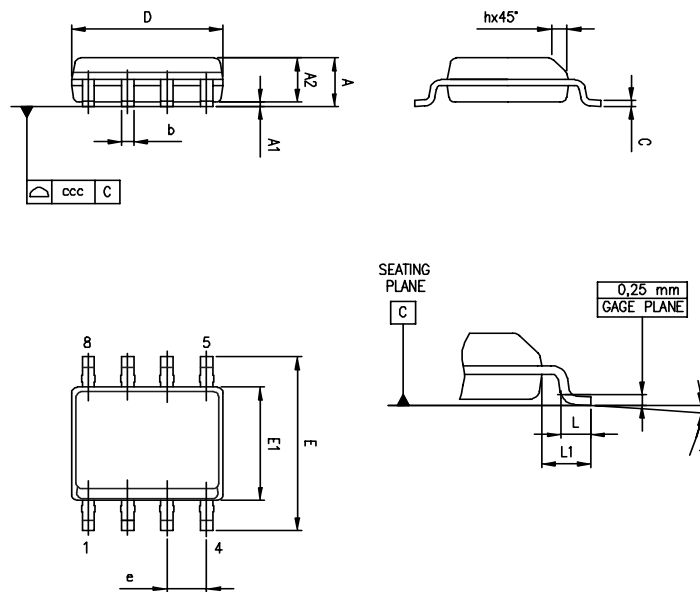

Table 6. SO8 package mechanical data

Ref.	Dimensions					
	Millimeters			Inches		
	Min.	Typ.	Max.	Min.	Typ.	Max.
A			1.75			0.069
A1	0.10		0.25	0.004		0.010
A2	1.25			0.049		
b	0.28		0.48	0.011		0.019
c	0.17		0.23	0.007		0.010
D	4.80	4.90	5.00	0.189	0.193	0.197
E	5.80	6.00	6.20	0.228	0.236	0.244
E1	3.80	3.90	4.00	0.150	0.154	0.157
e		1.27			0.050	
h	0.25		0.50	0.010		0.020
L	0.40		1.27	0.016		0.050
L1		1.04			0.040	
k	0°		8°	0°		8°
ccc			0.10			0.004

7.2 TSSOP8 package information

Figure 18. TSSOP8 package outline

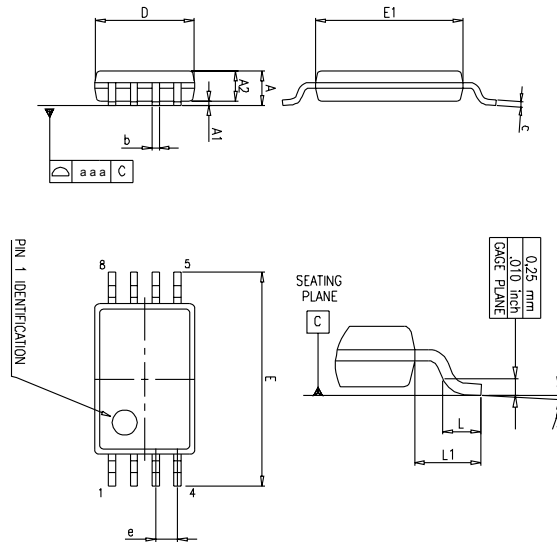

Table 7. TSSOP8 package mechanical data

Ref.	Dimensions					
	Millimeters			Inches		
	Min.	Typ.	Max.	Min.	Typ.	Max.
A			1.20			0.047
A1	0.05		0.15	0.002		0.006
A2	0.80	1.00	1.05	0.031	0.039	0.041
b	0.19		0.30	0.007		0.012
c	0.09		0.20	0.004		0.008
D	2.90	3.00	3.10	0.114	0.118	0.122
E	6.20	6.40	6.60	0.244	0.252	0.260
E1	4.30	4.40	4.50	0.169	0.173	0.177
e		0.65			0.0256	
k	0°		8°	0°		8°
L	0.45	0.60	0.75	0.018	0.024	0.030
L1		1			0.039	
aaa			0.10			0.004

7.3 DFN8 2x2 package information

Figure 19. DFN8 2x2 package outline

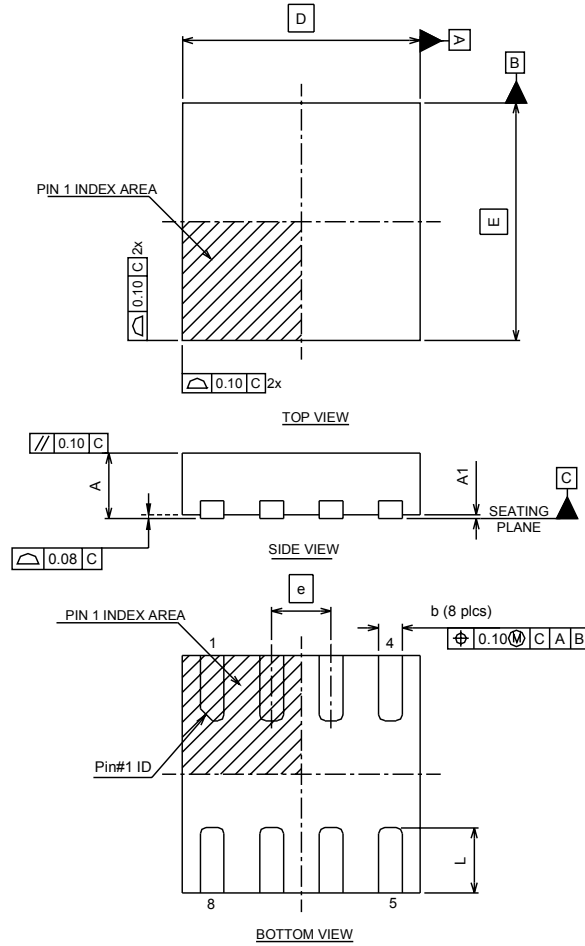
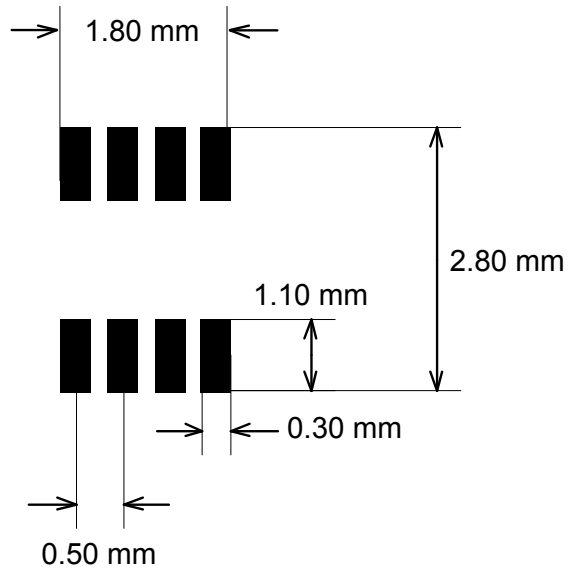

Table 8. DFN8 2x2 mechanical data

Ref.	Dimensions					
	Millimeters			Inches		
	Min.	Typ.	Max.	Min.	Typ.	Max.
A	0.70	0.75	0.80	0.028	0.030	0.031
A1	0.00	0.02	0.05	0.000	0.001	0.002
b	0.15	0.20	0.25	0.006	0.008	0.010
D		2.00			0.079	
E		2.00			0.079	
e		0.50			0.020	
L	0.045	0.55	0.65	0.018	0.022	0.026
N	8					

Figure 20. DFN8 2x2 recommended footprint



7.4 MiniSO8 package information

Figure 21. MiniSO8 package outline

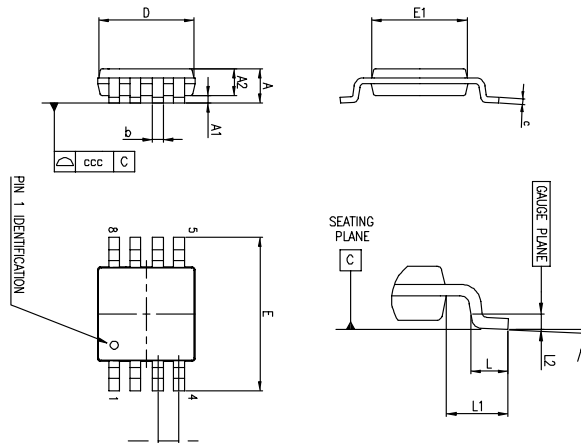

Table 9. MiniSO8 package mechanical data

Ref.	Dimensions					
	Millimeters			Inches		
	Min.	Typ.	Max.	Min.	Typ.	Max.
A			1.1			0.043
A1	0		0.15	0		0.0006
A2	0.75	0.85	0.95	0.030	0.033	0.037
b	0.22		0.40	0.009		0.016
c	0.08		0.23	0.003		0.009
D	2.80	3.00	3.20	0.11	0.118	0.126
E	4.65	4.90	5.15	0.183	0.193	0.203
E1	2.80	3.00	3.10	0.11	0.118	0.122
e		0.65			0.026	
L	0.40	0.60	0.80	0.016	0.024	0.031
L1		0.95			0.037	
L2		0.25			0.010	
k	0°		8°	0°		8°
ccc			0.10			0.004

8 Ordering information

Table 10. Order codes

Order code	Temperature range	Package	Packing	Marking
TSX3702IDT	-40 °C, 125 °C	SO8	Tape and reel	SX3702
TSX3702IPT		TSSOP8		S3702
TSX3702IST		MiniSO8		K532
TSX3702IQ2T		DFN8 2x2		K5J
TSX3702IYDT ⁽¹⁾		SO8 (automotive grade)		SX3702Y

1. Qualified and characterized according to AEC Q100 and Q003 or equivalent, advanced screening according to AEC Q001 & Q002 or equivalent.

Revision history

Table 11. Document revision history

Date	Revision	Changes
18-Apr-2014	1	Initial release.
13-Feb-2015	2	Table 1: Absolute maximum ratings (AMR): removed footnote associated with Vin. Table 2: Operating conditions: added footnote concerning Vicm. Figure 2: Schematic diagram (one operator): updated Table 6: added "L1"
06-Jun-2016	3	Table 3, Table 4, and Table 5: updated several values (Iio, lib, tPLH, and tPHL) and conditions (VOH, VOL, and CMR) Table 10: updated marking of order code TSX3702IPT (now SX3702 instead of 5X3702), updated automotive order code footnote.
15-May-2017	4	Updated automotive footnote in Table 10. Order codes.
02-Sep-2019	5	Updated Section 7.3 DFN8 2x2 package information .

Contents

1	Package pin connections	2
2	Absolute maximum ratings	3
3	Operating conditions	4
4	Schematic diagram	5
5	Electrical characteristics	6
6	Application information (input voltages)	14
7	Package information	15
7.1	SO8 package information	15
7.2	TSSOP8 package information	16
7.3	DFN8 2x2 package information	16
7.4	MiniSO8 package information	19
8	Ordering information	20
	Revision history	21

List of figures

Figure 1.	Pin connections top view	2
Figure 2.	Schematic diagram (one operator)	5
Figure 3.	Current consumption vs. supply voltage, output high	10
Figure 4.	Current consumption vs. supply voltage, output low	10
Figure 5.	Current consumption vs. input common-mode voltage, output high	10
Figure 6.	Current consumption vs. common-mode voltage, output low	10
Figure 7.	Output voltage drop vs. output source current, $V_{CC} = 5\text{ V}$	11
Figure 8.	Output voltage drop vs. output source current, $V_{CC} = 12\text{ V}$	11
Figure 9.	Output voltage drop vs. output sink current, $V_{CC} = 5\text{ V}$	11
Figure 10.	Output voltage drop vs. output sink current, $V_{CC} = 12\text{ V}$	11
Figure 11.	Input offset voltage distribution, $V_{CC} = 5\text{ V}$	12
Figure 12.	Input current versus input voltage, $V_{CC} = 5\text{ V}$	12
Figure 13.	Propagation delay t_{PLH} vs. input signal overdrive, $V_{CC} = 5\text{ V}$	12
Figure 14.	Propagation delay t_{PHL} vs. input signal overdrive, $V_{CC} = 5\text{ V}$	12
Figure 15.	Propagation delay t_{PLH} vs. supply voltage, $V_{CC} = 5\text{ V}$	13
Figure 16.	Propagation delay t_{PHL} vs. supply voltage, $V_{CC} = 5\text{ V}$	13
Figure 17.	SO8 package outline	15
Figure 18.	TSSOP8 package outline	16
Figure 19.	DFN8 2x2 package outline	17
Figure 20.	DFN8 2x2 recommended footprint	18
Figure 21.	MiniSO8 package outline	19

List of tables

Table 1.	Absolute maximum ratings (AMR)	3
Table 2.	Operating conditions	4
Table 3.	$V_{CC}^+ = 3\text{ V}$, $V_{CC}^- = 0\text{ V}$, $T_{amb} = 25\text{ }^\circ\text{C}$ (unless otherwise specified)	6
Table 4.	$V_{CC}^+ = 5\text{ V}$, $V_{CC}^- = 0\text{ V}$, $T_{amb} = 25\text{ }^\circ\text{C}$ (unless otherwise specified)	7
Table 5.	$V_{CC}^+ = 16\text{ V}$, $V_{CC}^- = 0\text{ V}$, $T_{amb} = 25\text{ }^\circ\text{C}$ (unless otherwise specified)	9
Table 6.	SO8 package mechanical data	15
Table 7.	TSSOP8 package mechanical data	16
Table 8.	DFN8 2x2 mechanical data	17
Table 9.	MiniSO8 package mechanical data	19
Table 10.	Order codes	20
Table 11.	Document revision history	21

IMPORTANT NOTICE – PLEASE READ CAREFULLY

STMicroelectronics NV and its subsidiaries (“ST”) reserve the right to make changes, corrections, enhancements, modifications, and improvements to ST products and/or to this document at any time without notice. Purchasers should obtain the latest relevant information on ST products before placing orders. ST products are sold pursuant to ST’s terms and conditions of sale in place at the time of order acknowledgement.

Purchasers are solely responsible for the choice, selection, and use of ST products and ST assumes no liability for application assistance or the design of Purchasers’ products.

No license, express or implied, to any intellectual property right is granted by ST herein.

Resale of ST products with provisions different from the information set forth herein shall void any warranty granted by ST for such product.

ST and the ST logo are trademarks of ST. For additional information about ST trademarks, please refer to www.st.com/trademarks. All other product or service names are the property of their respective owners.

Information in this document supersedes and replaces information previously supplied in any prior versions of this document.

© 2019 STMicroelectronics – All rights reserved