

QR/P4 SERIES

Small Rectangular Multi-electrode Solderless Connectors for Racks and Panels

General

QR/P4 Series is a series of small connectors for rack and panel application. This is a smaller-size version of the QR/P and QR/P1 Series, whose rectangular multi-electrode plug in connectors for racks and panels have been well received in the market.

Six models with different numbers of contacts are available: 8, 12, 16, 24, 32 and 40. Wires are connected to the connectors without solder for easier connection and higher reliability.

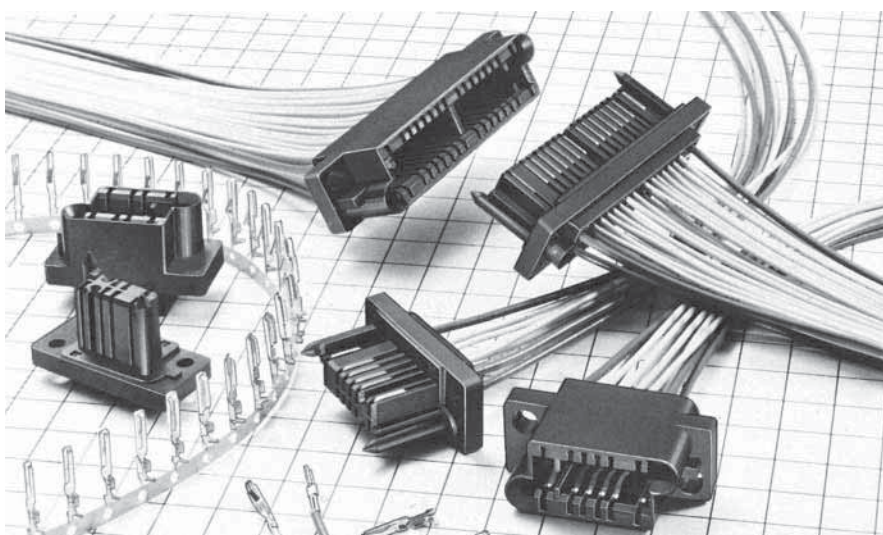

Features

- (1) The pins can be smoothly inserted into the receptacle, and give stable contact pressure because of their point contact with the receptacle blades. Furthermore, they have a larger allowance for the variation of connection length - a characteristic of plug-in connections.
- (2) The connector size has been made smaller by separating the terminals for signals from those for voltage supply.
- (3) The pitch of the signal terminals inside the housing is 2.54mm. Two pairs of diametrically opposed electrodes (four electrodes in total) on the two sides are arranged with a pitch of 5.08mm so that they can withstand high voltage, and can be used for power supply. In addition, a nonflammable material (UL94V-0) is used as the insulating housing of the connectors.
- (4) Guide pins and the housing body are molded as one piece to achieve a smaller connector size.
- (5) Since the connectors are mounted on racks or panels with stepped screws, connection and disconnection can be done easily.
- (6) The contact for female terminals in the housing is deeper than the fitting surface of the housing which conforms to the finger test (UL Standard 1950).
- (7) The connectors of this series have passed UL, CSA and TÜV standard.

Application

PPC, Transmission and reception equipment, Data Communication, Vending Machine, Measuring Instruments, Automatic Equipment, Switchboards, etc.

Specification

Item	Specifications	
Contact Resistance	Power	Max. 15mΩ at DC1A
	Signal	Max. 15mΩ at DC1A
Insulation Resistance	Min. 5000MΩ at DC500V	
Withstand Voltage (for 1 minute)	Power	AC 2000V
	Signal	AC 500V
Rated Current	Power	3A
	Signal	1A
Rated Voltage	Power	AC 300V
	Signal	AC 250V

Item	Material	Finish
Insulator	PBT resin *:UL94V-0	Black
Contact	Phosphor Bronze	Selective Gold plating over Nickel

Ratings authorized by QR/P4 safety standards			
Safety standard		UL CSA. TÜV	
Operating temperature		- 10 ~ + 60℃	
Rated Voltage	Power supply	AC 30V	AC380V, DC450V
	Signal unit	AC 250V	AC120V, DC150V
Rated current	AWG#20	3A	2.5A
	AWG#22		1A
	AWG#24	2A	
	AWG#26	1A	
	AWG#28		

Ordering Information

▲ Connector Unit QR / P4 — 12 P — C — (01)
 (1) (2)(3) (4) (10)

▲ Contact QR / P1 — PC 2 A — 1 1 1
 (1) (5) (6) (7)(8)(9)

- | | |
|--------------------------------------------|--------------------------------------------------------------------|
| (1) Series name | (6) Size of Barrel |
| (2) No.of contacts (8, 12, 16, 24, 32, 40) | 2A: Thin Wire (UL1007 Type) |
| (3) Type of Housing | 2B: Thin Wire (UL1007 Type) . . . For 4 contact holes at both ends |
| P: Plug Housing | (7) Contact Type |
| S: Socket Housing | 1: Loose Contact |
| (4) Type of termination | 2: Chain Contact |
| C: Crimping | (8) Applicable wire |
| (5) Type of Contact | 1: Thin Wire AWG #24 - #28 |
| PC: Pin Contact | 2: Thick Wire AWG #20 - #24 |
| SC: Socket Contact | (9) Finish |
| | 1: Selective Gold plated over Nickel |
| | (10) UL, CSA, TÜV |
| | Approved Spec |

Housing

Male Housing

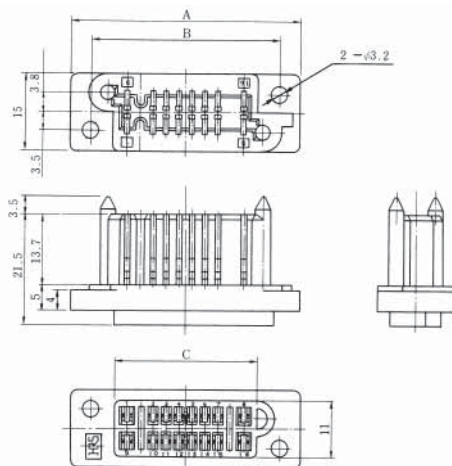
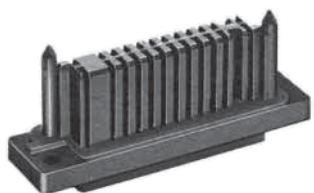

Unit: mm

HRS No.	No. of Pin	Part No.	A	B	C	RoHS
CL221-0159-5-01	8	QR/P4-8P-C(01)	34.68	26.68	17.68	○
CL221-0139-8-01	12	QR/P4-12P-C(01)	39.8	31.8	22.8	
CL221-0155-4-01	16	QR/P4-16P-C(01)	44.84	36.84	27.84	
CL221-0141-0-01	24	QR/P4-24P-C(01)	55	47	38	
CL221-0153-9-01	32	QR/P4-32P-C(01)	67.7	59.7	50.7	
CL221-0211-3-01	40	QR/P4-40P-C(01)	77.86	69.86	60.86	

Female Housing

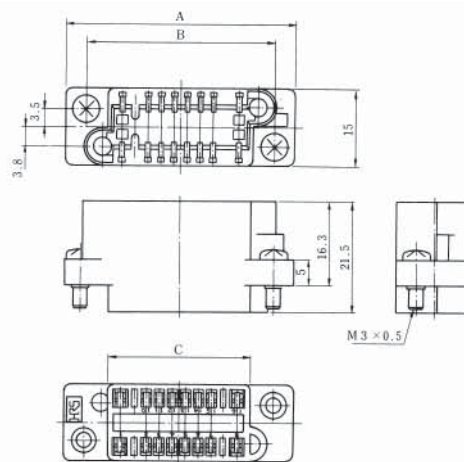

Unit: mm

HRS No.	No. of Pin	Part No.	A	B	C	RoHS
CL221-0160-4-01	8	QR/P4-8S-C(01)	34.68	26.68	17.68	○
CL221-0140-7-01	12	QR/P4-12S-C(01)	39.8	31.8	22.8	
CL221-0156-7-01	16	QR/P4-16S-C(01)	44.84	36.84	27.84	
CL221-0142-2-01	24	QR/P4-24S-C(01)	55	47	38	
CL221-0154-1-01	32	QR/P4-32S-C(01)	67.7	59.7	50.7	
CL221-0212-6-01	40	QR/P4-40S-C(01)	77.86	69.86	60.86	

Note: Determine the combinations with the panel so that the mating clearance between the P side and S side is 1.5mm or less.

Contact

Power Male Contact

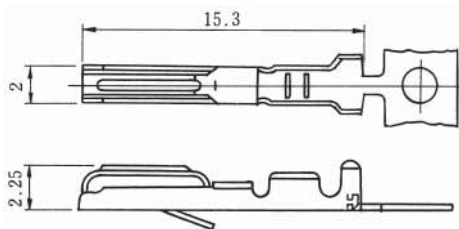

Power Female Contact

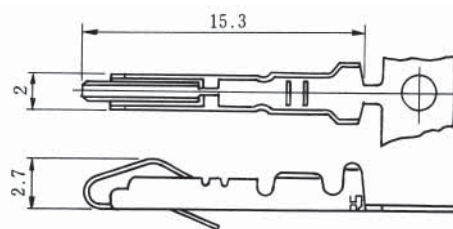

Selective gold plated with nickel under plating

Applicable Wire	HRS No.	Part No.	Type	Packing	RoHS
AWG#20~24	CL221-0115-0-12	QR/P1-PC2B-121(12)	Loose contact	100pin	○
	CL221-0119-0-12	QR/P1-PC2B-221(12)	Chain contact	5,000pin	

Selective gold plated with nickel under plating

Applicable Wire	HRS No.	Part No.	Type	Packing	RoHS
AWG#20~24	CL221-0117-2-12	QR/P1-SC2B-121(12)	Loose contact	100pin	○
	CL221-0121-2-12	QR/P1-SC2B-221(12)	Chain contact	5,000pin	

Contact

Signal Male Contact

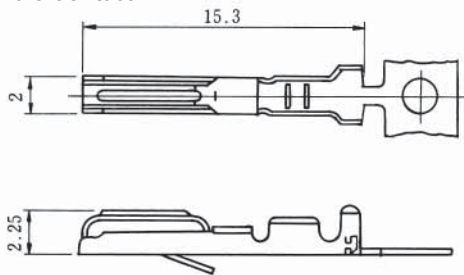

Partly gold plated over nickel plating

Applicable Wire	HRS No.	Part No.	Type	Packing	RoHS
AWG#20~24	CL221-0103-0-12	QR/P1-PC2A-111 (12)	Loose contact	100pin	○
	CL221-0107-1-12	QR/P1-PC2A-211 (12)	Chain contact	5,000pin	

Signal Female Contact

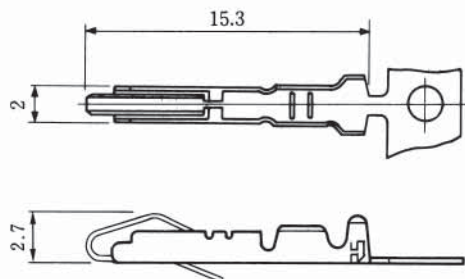

Partly gold plated over nickel plating

Applicable Wire	HRS No.	Part No.	Type	Packing	RoHS
AWG#24~28	CL221-0105-6-12	QR/P1-SC2A-111 (12)	Loose contact	100pin	○
	CL221-0109-7-12	QR/P1-SC2A-211 (12)	Chain contact	5,000pin	

Panel Cutout

QR/P4-※P-C

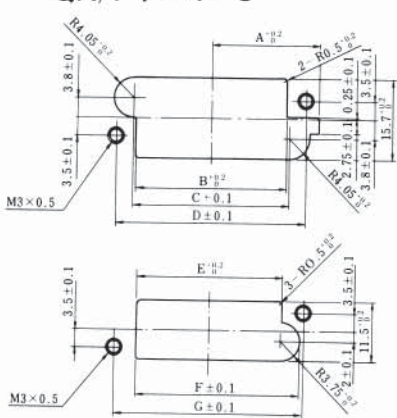

No. of pin		8pin	12pin	16pin	24pin	32pin	40pin
Rear Mounting	A	15.87	18.45	20.97	26.05	32.4	37.48
	B	19.18	24.3	29.34	39.5	52.2	62.36
	C	20.18	25.3	30.34	40.5	53.2	63.36
	D	26.68	31.8	36.84	47	59.7	69.86
Front Mounting	E	18.18	23.3	28.34	38.5	51.2	61.36
	F	21.68	26.8	31.84	42	54.7	64.86
	G	26.68	31.8	36.84	47	59.7	69.86

QR/P4-※S-C

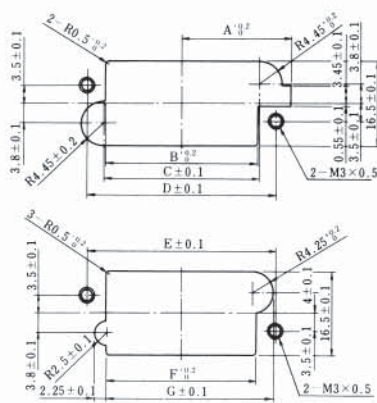

No. of pin		8pin	12pin	16pin	24pin	32pin	40pin
Rear Mounting	A	16.87	18.95	21.49	26.57	32.9	37.98
	B	19.68	24.8	29.84	40	52.7	62.86
	C	20.18	25.3	30.34	40.5	53.2	63.36
	D	26.68	31.8	36.84	47	59.7	69.86
Front Mounting	E	26.68	31.8	38.84	47	59.7	69.86
	F	19.18	24.3	29.34	39.5	52.2	62.36
	G	22.68	27.8	32.84	43	55.7	65.68

Tooling

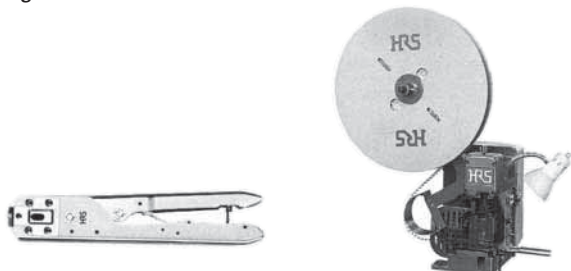

Hand Crimp Tool

Auto Crimp Machine
CM-105
CL901-0005-4

Kind	HRS No.	Part No.	Applicator Contact
Hand Crimp Tool	CL250-0021-3	TC-QR/P1-PC2B	QR/P1-PC2B-121
	CL250-0016-3	TC-QR/P1-PC2A	QR/P1-PC2A-111
	CL250-0023-9	TC-QR/P1-SC2B	QR/P1-SC2B-121
	CL250-0018-9	TC-QR/P1-SC2A	QR/P1-SC2A-111
Auto Crimp Machine Applicator	CL901-2530-5	AP105-QR/P1-2B-2	QR/P1-PC2B-221
			QR/P1-SC2B-221
	CL901-2528-3	AP105-QR/P1-2A-1	QR/P1-PC2A-211
Extraction Tool	CL250-0029-5	TC-QR/P4-21	QR/P1-SC2A-211
			QR/P1-SC2, PC2

Contacts for thick wire Contact Configuration

Male Housing (Viewed from Wiring Side)

■: indicates a contact hole for thick wire



QR/P4-8P-C (01)



QR/P4-12P-C (01)

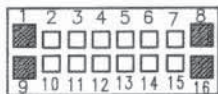

QR/P4-16P-C (01)

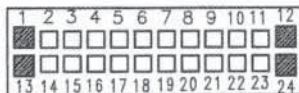

QR/P4-24P-C (01)

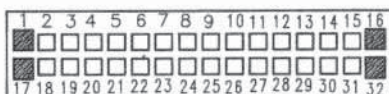

QR/P4-32P-C (01)

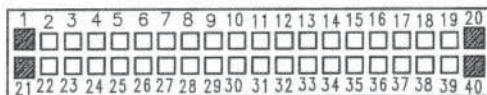

QR/P4-40P-C (01)