

MINNIE-LT-W-PIN

~35° wide beam. Assembly with location pins and installation tape.

TECHNICAL SPECIFICATIONS:

Dimensions	Ø 35.0 mm
Height	15.6 mm
Fastening	tape, pin
ROHS compliant	yes ⓘ



MATERIAL SPECIFICATIONS:

Component	Type	Material	Colour	Finish
MINNIE-LT-W-PIN	Reflector	PC	metal	
SPUTNIK-TAPE3	Tape	Acrylic foam	black	



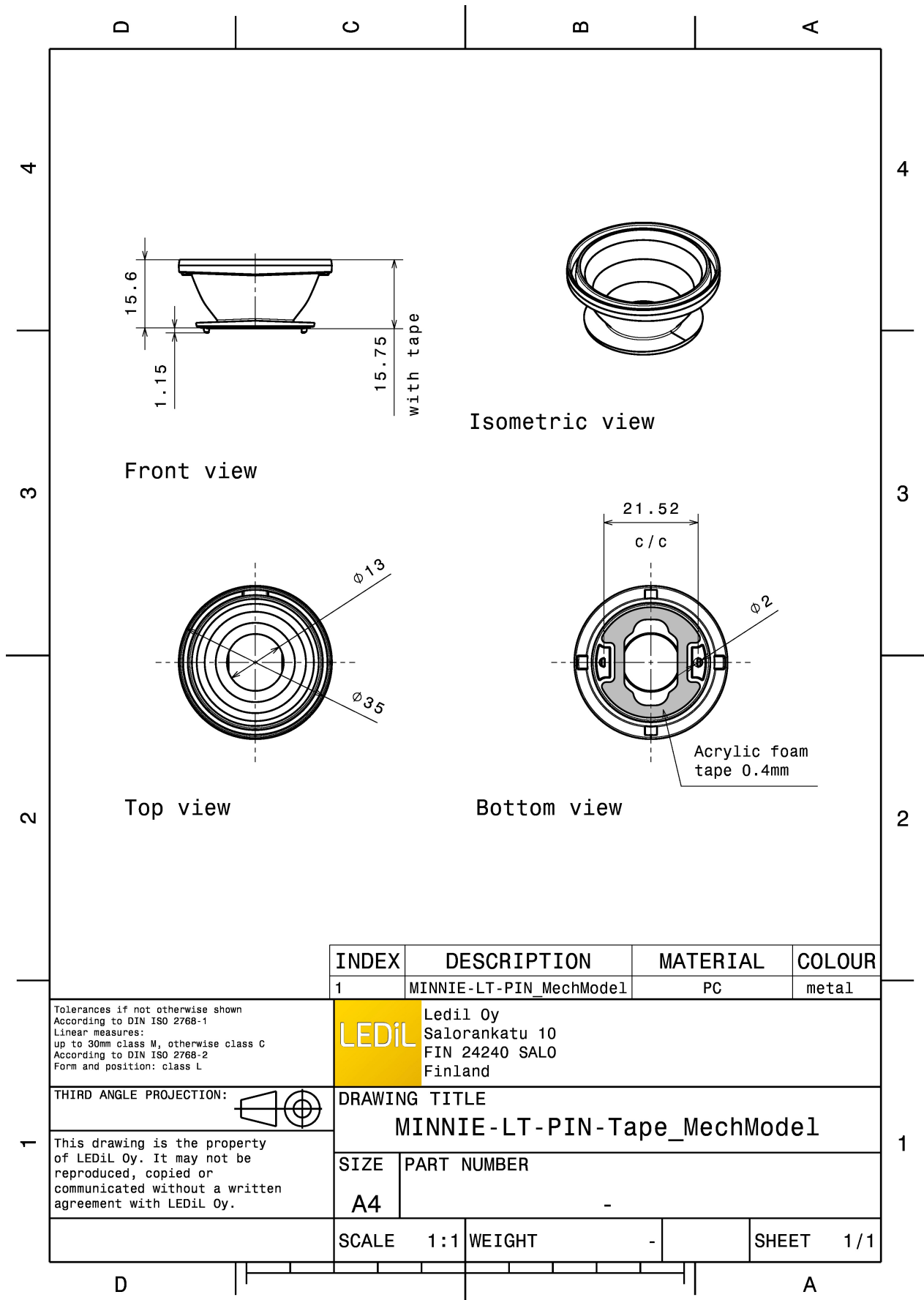

ORDERING INFORMATION:

Component	Type	Qty in box	MOQ	MPQ	Box weight (kg)
CA14942_MINNIE-LT-W-PIN » Box size: 480 x 280 x 300 mm	Reflector	720	90	45	3.6

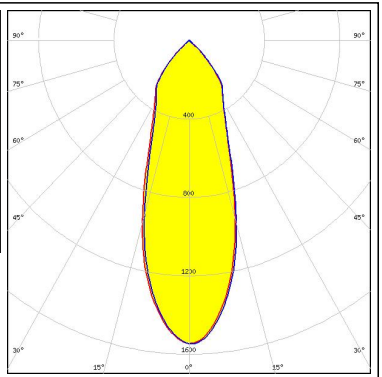

See also our general installation guide: www.ledil.com/installation_guide

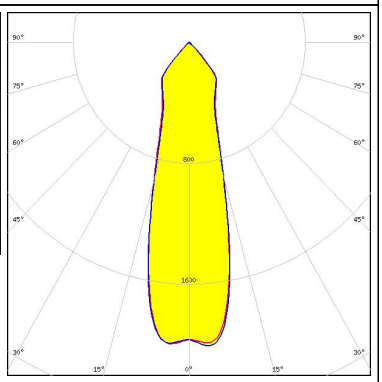
PHOTOMETRIC DATA (MEASURED):

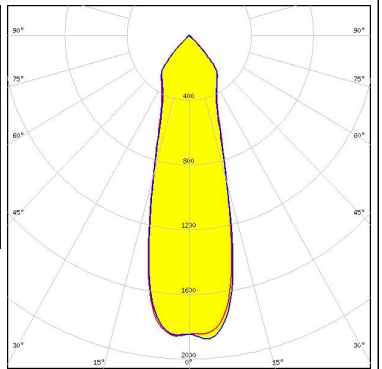
<p>CREE LED</p> <p>LED XHP70.2 FWHM / FWTM 35.0° / 87.0° Efficiency 91 % Peak intensity 1.6 cd/lm LEDs/each optic 1 Light colour White Required components:</p>		
<p>LUMILEDS</p> <p>LED LUXEON 5050 Round LES FWHM / FWTM 29.0° / 84.0° Efficiency 93 % Peak intensity 2 cd/lm LEDs/each optic 1 Light colour White Required components:</p>		
<p>LUMILEDS</p> <p>LED LUXEON M/MX FWHM / FWTM 30.0° / 90.0° Efficiency 93 % Peak intensity 1.9 cd/lm LEDs/each optic 1 Light colour White Required components:</p>		
<p>LUMILEDS</p> <p>LED LUXEON M/MX FWHM / FWTM 30.0° / 84.0° Efficiency 91 % Peak intensity 1.9 cd/lm LEDs/each optic 1 Light colour White Required components:</p>		

PHOTOMETRIC DATA (MEASURED):

LUMILEDS

LED LUXEON MZ
 FWHM / FWTM 27.0° / 83.0°
 Efficiency 93 %
 Peak intensity 2.3 cd/lm
 LEDs/each optic 1
 Light colour White
 Required components:

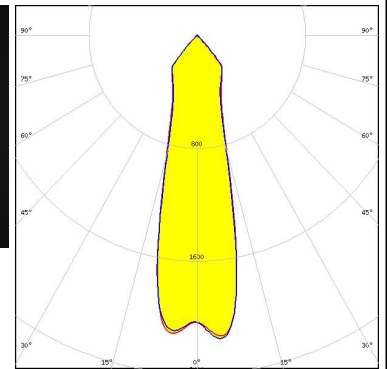

LUMILEDS

LED LUXEON V
 FWHM / FWTM 24.0° / 83.0°
 Efficiency 92 %
 Peak intensity 2.4 cd/lm
 LEDs/each optic 1
 Light colour White
 Required components:

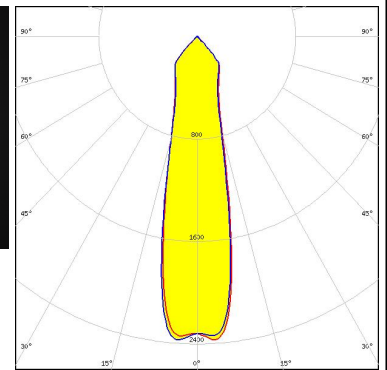
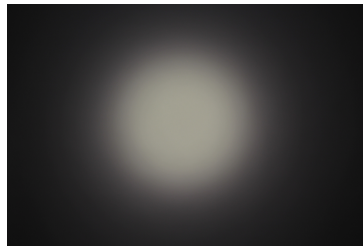

NICHIA

LED NFMW48xA
 FWHM / FWTM 29.0° / 83.0°
 Efficiency 92 %
 Peak intensity 2 cd/lm
 LEDs/each optic 1
 Light colour White
 Required components:

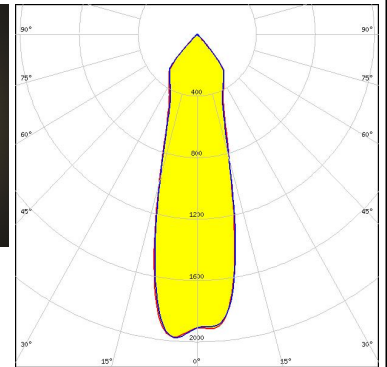
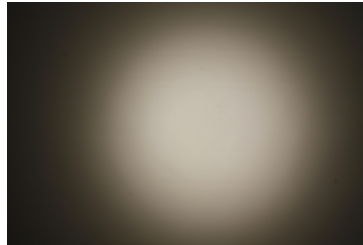

OSRAM

Opto Semiconductors
 LED Duris S10
 FWHM / FWTM 34.0° / 84.0°
 Efficiency 91 %
 Peak intensity 1.7 cd/lm
 LEDs/each optic 1
 Light colour White
 Required components:

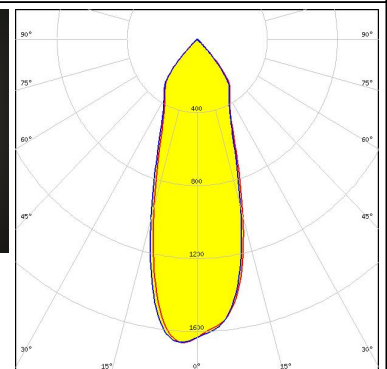
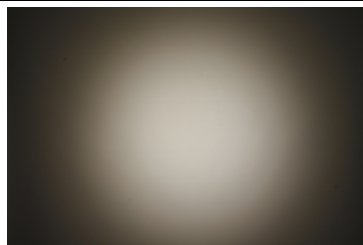

PHOTOMETRIC DATA (MEASURED):

OSRAM
Opto Semiconductors

LED OSCONIQ P 7070
FWHM / FWTM 29.0° / 84.0°
Efficiency 92 %
Peak intensity 1.9 cd/lm
LEDs/each optic 1
Light colour White
Required components:

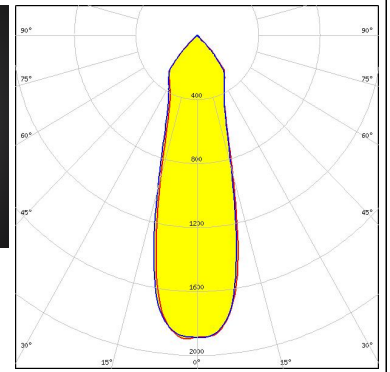

PHOTOMETRIC DATA (SIMULATED):

<p>CREE → LED</p> <p>LED: MK-R FWHM / FWTM: 40.0° / 89.0° Efficiency: 93 % Peak intensity: 1.4 cd/lm LEDs/each optic: 1 Light colour: White Required components:</p>	
<p>CREE → LED</p> <p>LED: XHP50.3 HD FWHM / FWTM: 30.0° / 79.0° Efficiency: 94 % Peak intensity: 2.4 cd/lm LEDs/each optic: 1 Light colour: White Required components:</p>	
<p>CREE → LED</p> <p>LED: XHP70.3 FWHM / FWTM: 36.0° / 84.0° Efficiency: 94 % Peak intensity: 1.9 cd/lm LEDs/each optic: 1 Light colour: White Required components:</p>	
<p>CREE → LED</p> <p>LED: XP-G3 FWHM / FWTM: 34.0° / 85.0° Efficiency: 90 % Peak intensity: 1.7 cd/lm LEDs/each optic: 1 Light colour: White Required components:</p>	

PHOTOMETRIC DATA (SIMULATED):



LED XT-E
FWHM / FWTM 30.0° / 83.0°
Efficiency 90 %
Peak intensity 2 cd/lm
LEDs/each optic 1
Light colour White
Required components:

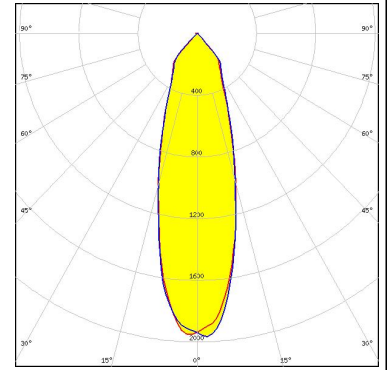

LED LUXEON 7070
FWHM / FWTM 32.0° / 75.0 + 74.0°
Efficiency 96 %
Peak intensity 2.4 cd/lm
LEDs/each optic 1
Light colour White
Required components:

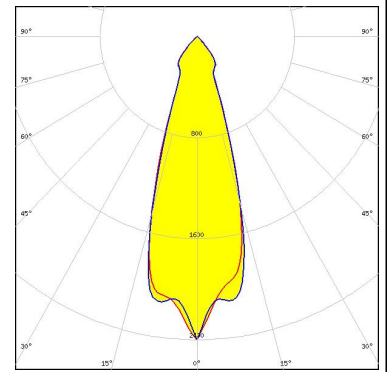

GENERAL INFORMATION:

NOTE: The typical beam angle will be changed by different color, chip size and chip position tolerance. The typical total beam angle is the full angle measured where the luminous intensity is half of the peak value.

MATERIALS:

As part of our continuous research and improvement processes, and to ensure the best possible quality and availability of our products, LEDiL reserves the right to change material grades without notice.

PRODUCT DATA USER AGREEMENT AND DISCLAIMER:

The measured data in the provided downloadable LEDiL Product Datasheets and Mechanical 2D-Drawings is rounded and provided as reference for planning. LEDiL Oy's optical specifications have been verified by conducting performance testing of the products in accordance with the company's quality system. The reported data are averaged results of multiple measurements with typical variation. LEDiL Oy reserves the right to without prior notification make changes and improvements to its products.

LEDiL Oy assumes neither warranty, nor guarantee nor any other liability of any kind for the contents and correctness of the provided data. The provided data has been generated with highest diligence but the provided data may in reality not represent the complete possible variation range of all intrinsic parameters. Therefore, in certain cases a deviation from the provided data could occur.

LEDiL Oy reserves the right to undertake technical changes of its products without further notification which could lead to changes in the provided data. LEDiL Oy assumes no liability of any kind for the possible deviation from any provided data or any other damage resulting from the usage of the provided data.

The user agrees to this disclaimer and user agreement with the download or usage of the provided files.

LEDiL Oy

Joensuunkatu 13
FI-24240 SALO
Finland

LEDiL Inc.

228 West Page Street
Suite D
Sycamore IL 60178
USA

Ledil Optics Technology (Shenzhen) Co., Ltd.

405 , Block B
Casic Motor Building
Shenzhen 518057
P.R.CHINA

Local sales and technical support

[www.ledil.com/
where_to_buy](http://www.ledil.com/where_to_buy)

Shipping locations

Salo, Finland
Hong Kong, China

Distribution Partners

[www.ledil.com/
where_to_buy](http://www.ledil.com/where_to_buy)