

## VERONICA-SQ-MINI-W

~55° wide beam

### TECHNICAL SPECIFICATIONS:

Dimensions	13.9 x 13.9 mm
Height	8.9 mm
Fastening	tape, pin
ROHS compliant	yes ⓘ

### MATERIAL SPECIFICATIONS:

Component	Type	Material	Colour	Finish
VERONICA-SQ-MINI-W	Single lens	PMMA	clear	
VERONICA-SQ-MINI-TAPE	Tape	Acrylic foam	clear	



### ORDERING INFORMATION:

Component	Type	Qty in box	MOQ	MPQ	Box weight (kg)
CA15231_VERONICA-SQ-MINI-W » Box size: 480 x 280 x 300 mm	Single lens	5544	252	252	8.6

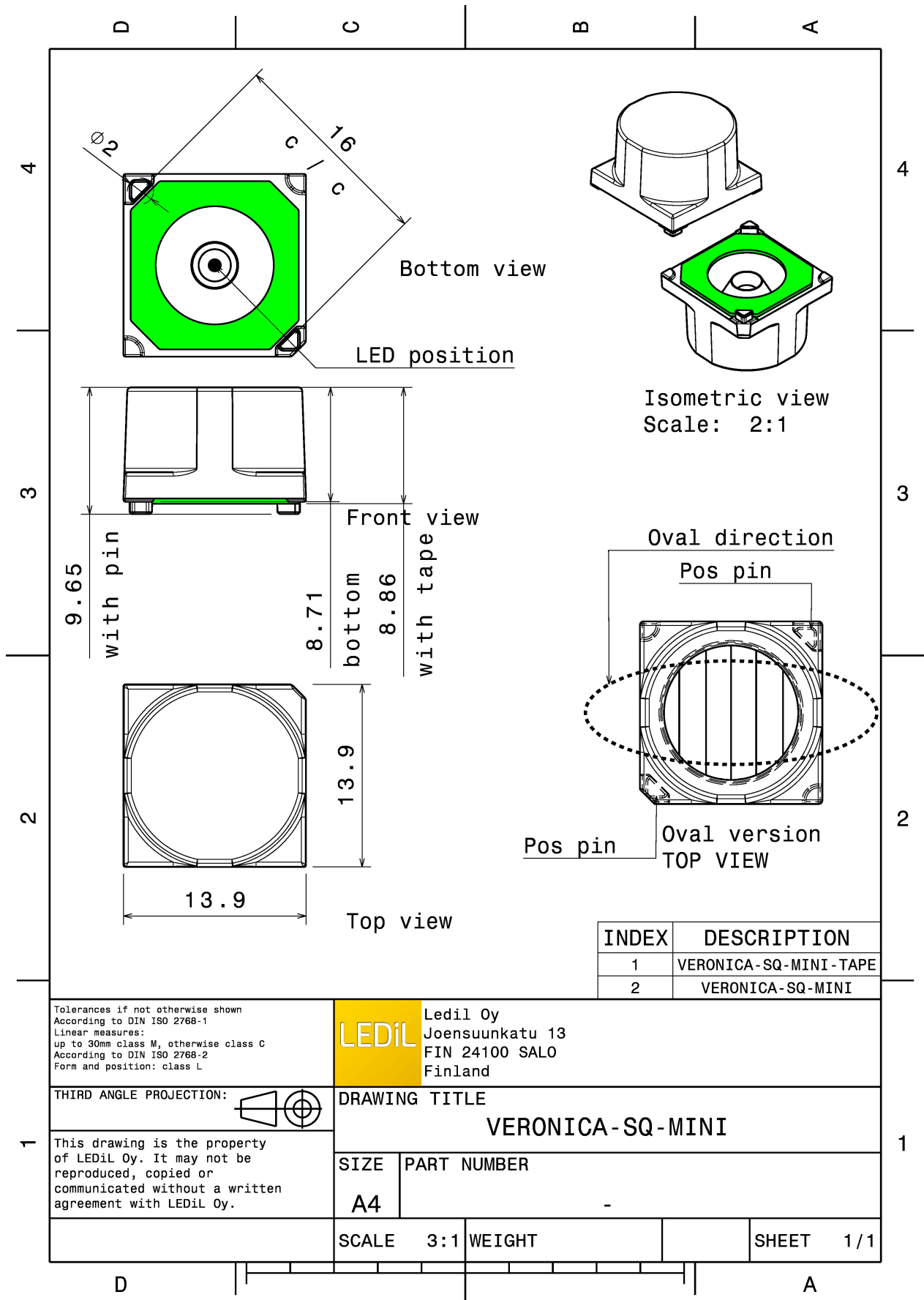

See also our general installation guide: [www.ledil.com/installation\\_guide](http://www.ledil.com/installation_guide)

#### PHOTOMETRIC DATA (MEASURED):



LED XP-G2  
 FWHM / FWTM 56.8° / 87.5°  
 Efficiency 91 %  
 Peak intensity 1 cd/lm  
 LEDs/each optic 1  
 Light colour White  
 Required components:

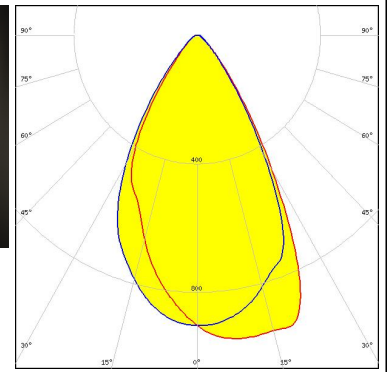

LED XP-G3  
 FWHM / FWTM 49.0° / 89.0°  
 Efficiency 94 %  
 Peak intensity 1.1 cd/lm  
 LEDs/each optic 1  
 Light colour White  
 Required components:

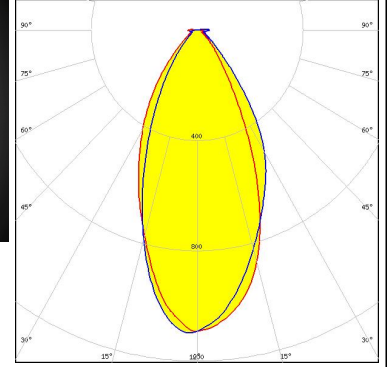

LED NCSxE17A  
 FWHM / FWTM 28.0° / 65.0°  
 Efficiency 91 %  
 Peak intensity 2.1 cd/lm  
 LEDs/each optic 1  
 Light colour White  
 Required components:

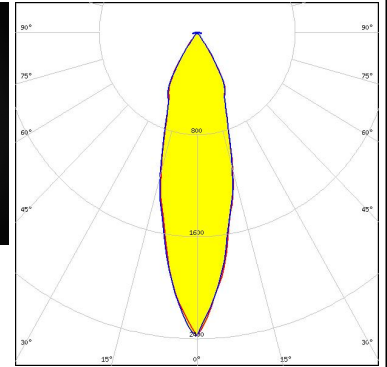
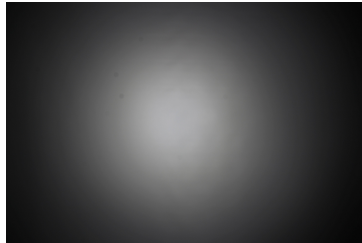

LED NVSxx19B/NVSxx19C  
 FWHM / FWTM 50.0° / 85.0°  
 Efficiency 92 %  
 Peak intensity 1.1 cd/lm  
 LEDs/each optic 1  
 Light colour White  
 Required components:

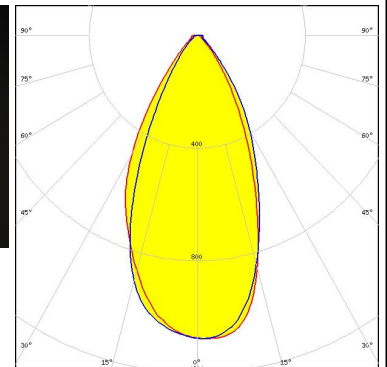
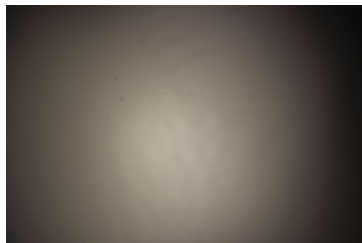

#### PHOTOMETRIC DATA (MEASURED):

#### OSRAM

Opto Semiconductors

LED Duris S5 (2 chip)  
 FWHM / FWTM 34.0° / 69.0°  
 Efficiency 82 %  
 Peak intensity 1.7 cd/lm  
 LEDs/each optic 1  
 Light colour White  
 Required components:

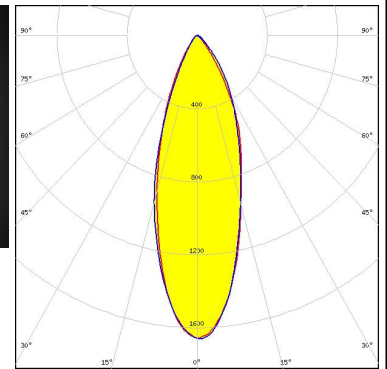
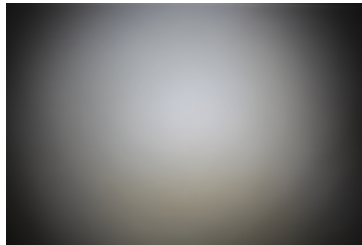

#### OSRAM

Opto Semiconductors

LED SFH 4170S  
 FWHM / FWTM 31.0° / 72.0°  
 Efficiency %  
 LEDs/each optic 1  
 Light colour IR  
 Required components:

#### OSRAM

Opto Semiconductors

LED SFH 4180S  
 FWHM / FWTM 30.0° / 72.0°  
 Efficiency %  
 LEDs/each optic 1  
 Light colour IR  
 Required components:

#### SAMSUNG

LED LH181A  
 FWHM / FWTM 32.0° / 68.0°  
 Efficiency 89 %  
 Peak intensity 1.5 cd/lm  
 LEDs/each optic 1  
 Light colour White  
 Required components:

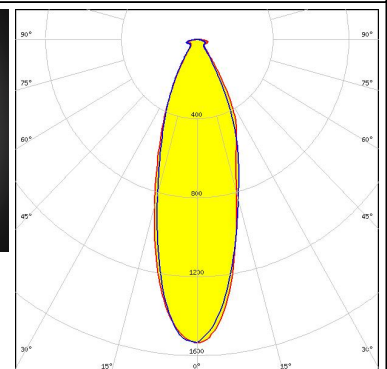
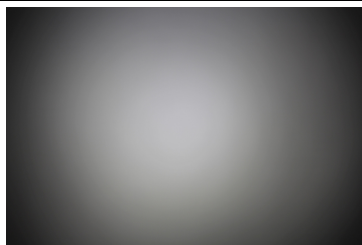

#### PHOTOMETRIC DATA (MEASURED):

#### SAMSUNG

LED LH181B  
 FWHM / FWTM 37.0° / 71.0°  
 Efficiency 94 %  
 Peak intensity 1.6 cd/lm  
 LEDs/each optic 1  
 Light colour White  
 Required components:

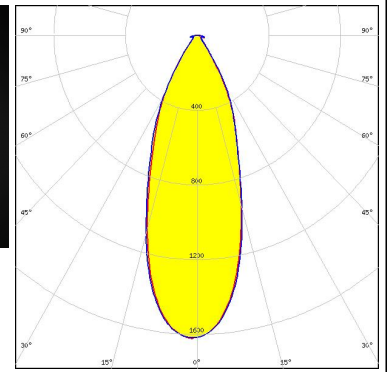
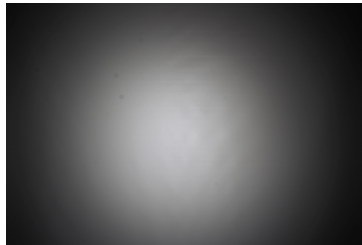

SEOUL SEMICONDUCTOR  
 LED Z8Y22P  
 FWHM / FWTM 46.0° / 82.0°  
 Efficiency 92 %  
 Peak intensity 1.1 cd/lm  
 LEDs/each optic 1  
 Light colour White  
 Required components:

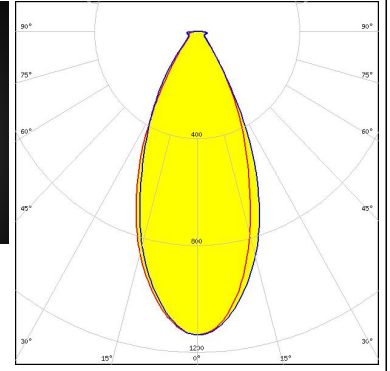

#### PHOTOMETRIC DATA (SIMULATED):



LED J Series 3030  
 FWHM / FWTM 38.0° / 72.0°  
 Efficiency 96 %  
 Peak intensity 1.8 cd/lm  
 LEDs/each optic 1  
 Light colour White  
 Required components:

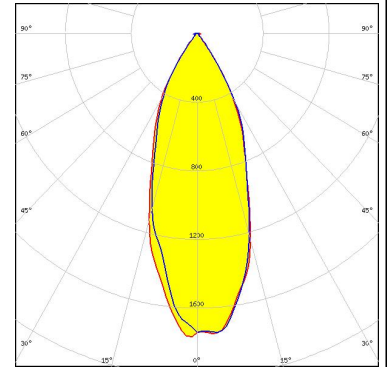

LED XP-E2  
 FWHM / FWTM 66.0° / 84.0°  
 Efficiency 96 %  
 Peak intensity 1 cd/lm  
 LEDs/each optic 1  
 Light colour White  
 Required components:

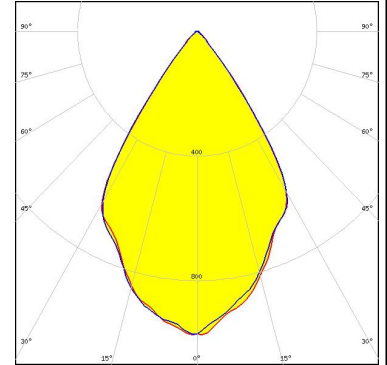

LED XQ-E HD  
 FWHM / FWTM 48.0° / 76.0°  
 Efficiency 96 %  
 Peak intensity 1.4 cd/lm  
 LEDs/each optic 1  
 Light colour White  
 Required components:



LED LUXEON 2835 Line  
 FWHM / FWTM 41.0° / 74.0°  
 Efficiency 96 %  
 Peak intensity 1.7 cd/lm  
 LEDs/each optic 1  
 Light colour PC Amber  
 Required components:

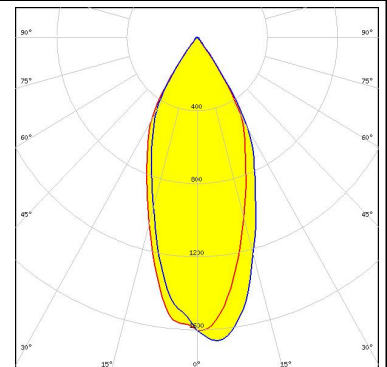



#### PHOTOMETRIC DATA (SIMULATED):



LED NVSxE21A  
 FWHM / FWTM 34.0° / 68.0°  
 Efficiency 94 %  
 Peak intensity 1.9 cd/lm  
 LEDs/each optic 1  
 Light colour White  
 Required components:

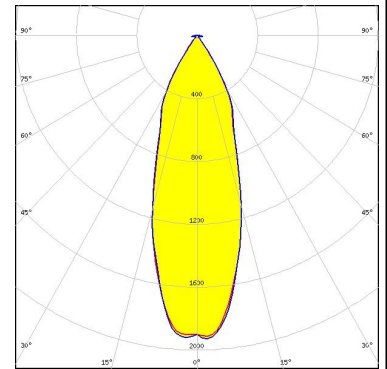

LED OSLOM Square CSSRM2/CSSRM3  
 FWHM / FWTM 57.0° / 80.0°  
 Efficiency 97 %  
 Peak intensity 1.3 cd/lm  
 LEDs/each optic 1  
 Light colour White  
 Required components:

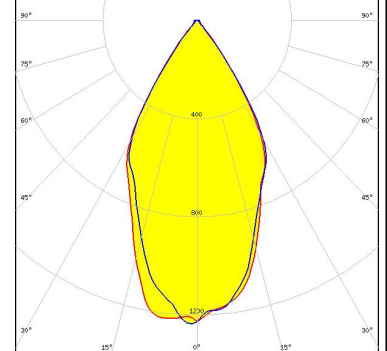

LED LH351B  
 FWHM / FWTM 65.0° / 90.0°  
 Efficiency 94 %  
 Peak intensity 0.9 cd/lm  
 LEDs/each optic 1  
 Light colour White  
 Required components:

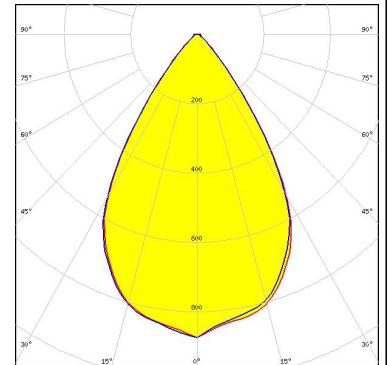

SEOUL SEMICONDUCTOR

LED Z8Y22T  
 FWHM / FWTM 41.0° / 72.0°  
 Efficiency 94 %  
 Peak intensity 1.6 cd/lm  
 LEDs/each optic 1  
 Light colour White  
 Required components:

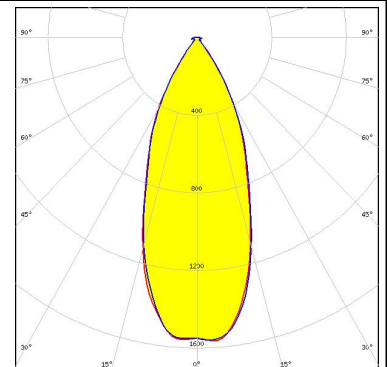

#### GENERAL INFORMATION:

NOTE: The typical beam angle will be changed by different color, chip size and chip position tolerance. The typical total beam angle is the full angle measured where the luminous intensity is half of the peak value.

#### MATERIALS:

As part of our continuous research and improvement processes, and to ensure the best possible quality and availability of our products, LEDiL reserves the right to change material grades without notice.

#### PRODUCT DATA USER AGREEMENT AND DISCLAIMER:

The measured data in the provided downloadable LEDiL Product Datasheets and Mechanical 2D-Drawings is rounded and provided as reference for planning. LEDiL Oy's optical specifications have been verified by conducting performance testing of the products in accordance with the company's quality system. The reported data are averaged results of multiple measurements with typical variation. LEDiL Oy reserves the right to without prior notification make changes and improvements to its products.

LEDiL Oy assumes neither warranty, nor guarantee nor any other liability of any kind for the contents and correctness of the provided data. The provided data has been generated with highest diligence but the provided data may in reality not represent the complete possible variation range of all intrinsic parameters. Therefore, in certain cases a deviation from the provided data could occur.

LEDiL Oy reserves the right to undertake technical changes of its products without further notification which could lead to changes in the provided data. LEDiL Oy assumes no liability of any kind for the possible deviation from any provided data or any other damage resulting from the usage of the provided data.

The user agrees to this disclaimer and user agreement with the download or usage of the provided files.

#### LEDiL Oy

Joensuunkatu 13  
FI-24240 SALO  
Finland

#### LEDiL Inc.

228 West Page Street  
Suite D  
Sycamore IL 60178  
USA

#### Ledil Optics Technology (Shenzhen) Co., Ltd.

# 405 , Block B  
Casic Motor Building  
Shenzhen 518057  
P.R.CHINA

#### Local sales and technical support

[www.ledil.com/  
where\\_to\\_buy](http://www.ledil.com/where_to_buy)

#### Shipping locations

Salo, Finland  
Hong Kong, China

#### Distribution Partners

[www.ledil.com/  
where\\_to\\_buy](http://www.ledil.com/where_to_buy)