

## EMILY-M2

~30° medium beam. 14.88 mm high lens.

### TECHNICAL SPECIFICATIONS:

Dimensions	Ø 26.0 mm
Height	14.9 mm
Fastening	tape, pin
ROHS compliant	yes ⓘ

### MATERIAL SPECIFICATIONS:

Component	Type	Material	Colour	Finish
EMILY-M2	Single lens	PMMA	clear	
SPUTNIK-TAPE	Tape	Acrylic foam	black	

### ORDERING INFORMATION:

Component		Qty in box	MOQ	MPQ	Box weight (kg)
CA11391_EMILY-M2	Single lens	1690	260	130	10.6
» Box size: 480 x 280 x 300 mm					



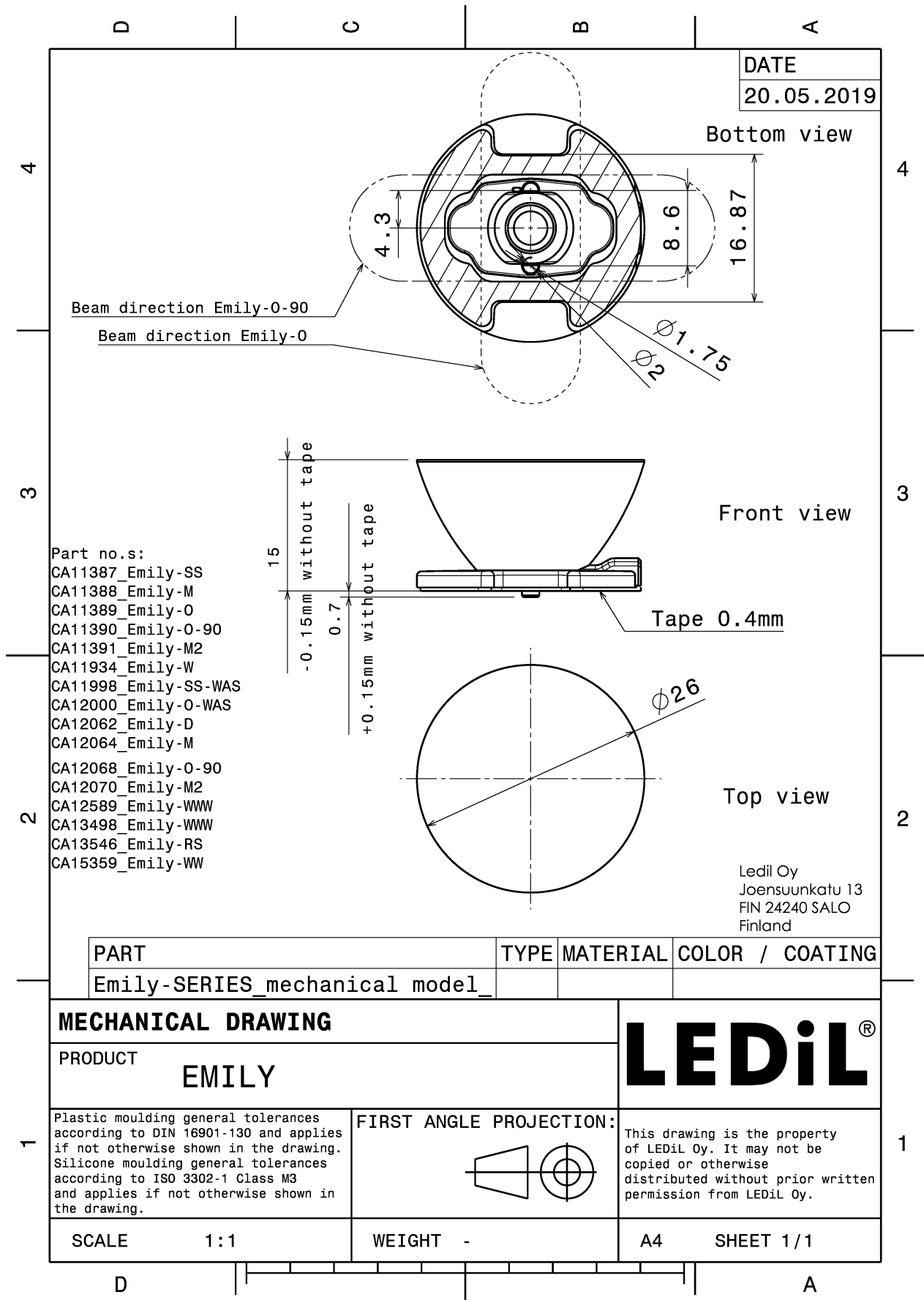

See also our general installation guide: [www.ledil.com/installation\\_guide](http://www.ledil.com/installation_guide)

#### PHOTOMETRIC DATA (MEASURED):

##### CREE LED

LED XB-H  
 FWHM / FWTM 30.0° / 47.0°  
 Efficiency 89 %  
 Peak intensity 3.3 cd/lm  
 LEDs/each optic 1  
 Light colour White  
 Required components:

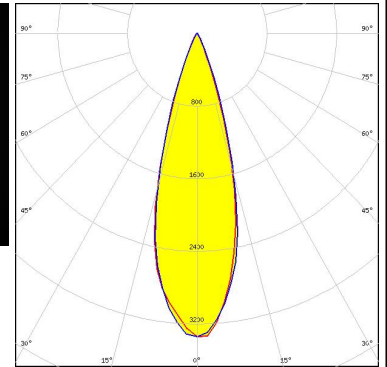
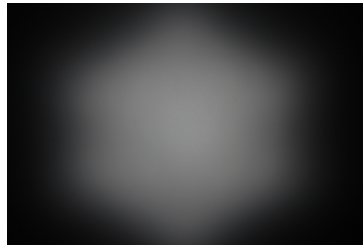

##### CREE LED

LED XP-E  
 FWHM / FWTM 29.0° / 47.0°  
 Efficiency 92 %  
 Peak intensity 3.2 cd/lm  
 LEDs/each optic 1  
 Light colour White  
 Required components:

##### CREE LED

LED XP-G  
 FWHM / FWTM 29.0° / 44.0°  
 Efficiency 92 %  
 Peak intensity 3.1 cd/lm  
 LEDs/each optic 1  
 Light colour White  
 Required components:

##### LUMILEDS

LED LUXEON Rebel  
 FWHM / FWTM 28.0°  
 Efficiency 87 %  
 LEDs/each optic 1  
 Light colour White  
 Required components:

### PHOTOMETRIC DATA (MEASURED):



LED NCSxx19A  
FWHM / FWTM 30.0°  
Efficiency 88 %  
LEDs/each optic 1  
Light colour White  
Required components:



LED NVSxx19A  
FWHM / FWTM 28.0° / 48.0°  
Efficiency 88 %  
Peak intensity 2.9 cd/m  
LEDs/each optic 1  
Light colour White  
Required components:



Ospto Semiconductors

LED OSLO<sup>n</sup> Square EC  
FWHM / FWTM 30.0° / 47.0°  
Efficiency 89 %  
Peak intensity 3.3 cd/m  
LEDs/each optic 1  
Light colour White  
Required components:

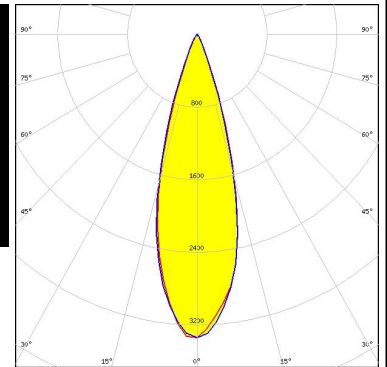

Ospto Semiconductors

LED OSLO<sup>n</sup> SSL 150  
FWHM / FWTM 30.0°  
Efficiency %  
LEDs/each optic 1  
Light colour White  
Required components:

## PHOTOMETRIC DATA (MEASURED):

### **OSRAM** Opto Semiconductors

LED OSLON SSL 80  
FWHM / FWTM 28.0°  
Efficiency 85 %  
LEDs/each optic 1  
Light colour White  
Required components:



### SEOUL SEMICONDUCTOR

LED Z5  
FWHM / FWTM 28.0°  
Efficiency %  
LEDs/each optic 1  
Light colour White  
Required components:

### **SHARP**

LED Double Dome (GM2BB)  
FWHM / FWTM 28.0°  
Efficiency %  
LEDs/each optic 1  
Light colour White  
Required components:

#### PHOTOMETRIC DATA (SIMULATED):

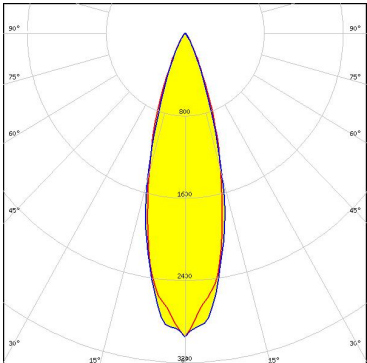
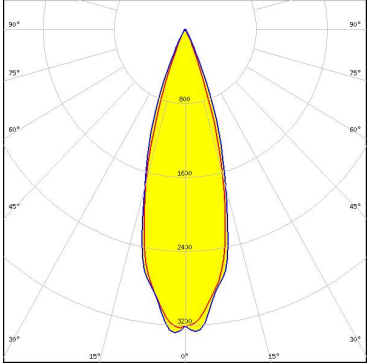
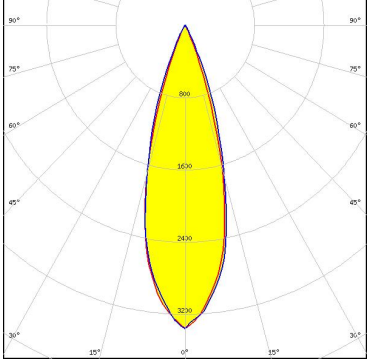
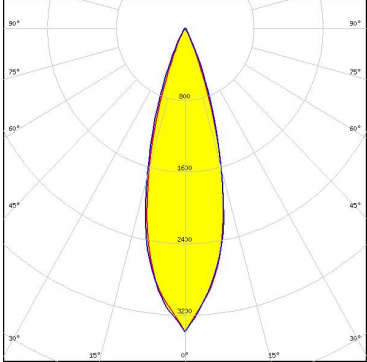
<p><b>NICHIA</b></p> <p>LED NCSxx19B</p> <p>FWHM / FWTM 28.0°</p> <p>Efficiency 89 %</p> <p>Peak intensity 2.9 cd/lm</p> <p>LEDs/each optic 1</p> <p>Light colour White</p> <p>Required components:</p>	
<p><b>OSRAM</b> Opto Semiconductors</p> <p>LED OSCONIQ P 3030</p> <p>FWHM / FWTM 31.0° / 49.0°</p> <p>Efficiency 96 %</p> <p>Peak intensity 3.3 cd/lm</p> <p>LEDs/each optic 1</p> <p>Light colour White</p> <p>Required components:</p>	
<p><b>OSRAM</b> Opto Semiconductors</p> <p>LED OSOLON Square CSSRM2/CSSRM3</p> <p>FWHM / FWTM 30.0° / 49.0°</p> <p>Efficiency 94 %</p> <p>Peak intensity 3.4 cd/lm</p> <p>LEDs/each optic 1</p> <p>Light colour White</p> <p>Required components:</p>	
<p><b>SAMSUNG</b></p> <p>LED LM28xB Series</p> <p>FWHM / FWTM 29.0° / 50.0°</p> <p>Efficiency 94 %</p> <p>Peak intensity 3.4 cd/lm</p> <p>LEDs/each optic 1</p> <p>Light colour White</p> <p>Required components:</p>	



### GENERAL INFORMATION:

NOTE: The typical beam angle will be changed by different color, chip size and chip position tolerance. The typical total beam angle is the full angle measured where the luminous intensity is half of the peak value.

### MATERIALS:

As part of our continuous research and improvement processes, and to ensure the best possible quality and availability of our products, LEDiL reserves the right to change material grades without notice.

### PRODUCT DATA USER AGREEMENT AND DISCLAIMER:

The measured data in the provided downloadable LEDiL Product Datasheets and Mechanical 2D-Drawings is rounded and provided as reference for planning. LEDiL Oy's optical specifications have been verified by conducting performance testing of the products in accordance with the company's quality system. The reported data are averaged results of multiple measurements with typical variation. LEDiL Oy reserves the right to without prior notification make changes and improvements to its products.

LEDiL Oy assumes neither warranty, nor guarantee nor any other liability of any kind for the contents and correctness of the provided data. The provided data has been generated with highest diligence but the provided data may in reality not represent the complete possible variation range of all intrinsic parameters. Therefore, in certain cases a deviation from the provided data could occur.

LEDiL Oy reserves the right to undertake technical changes of its products without further notification which could lead to changes in the provided data. LEDiL Oy assumes no liability of any kind for the possible deviation from any provided data or any other damage resulting from the usage of the provided data.

The user agrees to this disclaimer and user agreement with the download or usage of the provided files.

#### LEDiL Oy

Joensuunkatu 13  
FI-24240 SALO  
Finland

#### LEDiL Inc.

228 West Page Street  
Suite D  
Sycamore IL 60178  
USA

#### Ledil Optics Technology (Shenzhen) Co., Ltd.

# 405 , Block B  
Casic Motor Building  
Shenzhen 518057  
P.R.CHINA

#### Local sales and technical support

[www.ledil.com/  
where\\_to\\_buy](http://www.ledil.com/where_to_buy)

#### Shipping locations

Salo, Finland  
Hong Kong, China

#### Distribution Partners

[www.ledil.com/  
where\\_to\\_buy](http://www.ledil.com/where_to_buy)