

# WIMA DC-LINK MKP 4



**Metallized Polypropylene (PP) - Capacitors for DC-Link Applications.**  
**Capacitances from 1.0 µF to 400 µF.**  
**Rated Voltages from 400 VDC to 1500 VDC.**

## Special Features

- Capacitances up to 400 µF
- High volume/capacitance ratio
- Excellent self-healing properties
- Very low dissipation factor
- High reliability
- 2-pin, 4-pin or plate contact configuration
- AEC-Q200 qualified
- According to RoHS 2011/65/EU

## Typical Applications

As intermediate circuit capacitor e.g. in high power converter technology, power supplies, solar inverters, e-mobility (battery chargers, motor drives & power train) etc.

## Construction

### Dielectric:

Polypropylene (PP) film

### Capacitor electrodes:

Vacuum-deposited

### Internal construction:

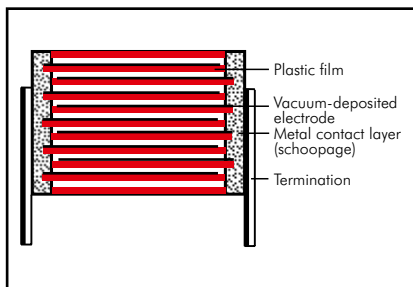

### Encapsulation:

Solvent-resistant, flame-retardant plastic case with epoxy resin seal, UL 94 V-0

### Terminations:

Tinned wire or plates.

### Marking:

Colour: Red. Marking: Black.

## Packing

Packing units at the end of the catalogue

## Electrical Data

**Capacitance range:** 1 µF to 400 µF (intermediate values on request)

**Rated voltages:** 400 VDC, 500 VDC, 600 VDC, 800 VDC, 900 VDC, 1100 VDC, 1300 VDC, 1500 VDC

**Capacitance tolerances:** ±20%, ±10%, ±5%

**Operating temperature range:**

-55° C to +105° C (hot spot including self-heating)

**Climatic test category:** 55/085/56

in accordance with IEC

**Insulation resistance** at +20° C:

≥ 30 000 sec (MΩ x µF)

Measuring voltage: 100 V/1 min.

**Dielectric absorption:** 0.05 %

**Voltage and current derating:**

A derating factor of 1.35% per K must be applied from +85° C for DC voltages and from +70° C for AC currents (I<sub>rms</sub>). Additionally a derating factor of 4.5% per K must be applied from +85° C for AC currents (I<sub>rms</sub>)

**Reliability:** Operational life > 100 000 hours (U<sub>r</sub> and 70° C)

Failure rate λ<sub>0</sub> (0.5 x U<sub>r</sub> and 40° C)

$\Pi =  C_N [\mu F] \times U_r [V] $	$\lambda_0$
$\Pi \leq 10\,000$	< 2 fit
$10\,000 < \Pi \leq 25\,000$	< 5 fit
$25\,000 < \Pi \leq 50\,000$	< 10 fit
$50\,000 < \Pi \leq 100\,000$	< 20 fit
$\Pi > 100\,000$	< 30 fit

**Test voltage:**

≤ 500 VDC: 1.5 U<sub>r</sub>, 2sec

> 500 VDC: 1.2 U<sub>r</sub>, 2sec

**Specific dissipation:**

Box size WxHxL in mm	Specific dissipation in Watts per K above the ambient temperature
9x19x31.5	0.021
11x21x31.5	0.025
13x24x31.5	0.030
15x26x31.5	0.034
17x29x31.5	0.039
17x34.5x31.5	0.044
20x39.5x31.5	0.053
13x24x41.5	0.037
15x26x41.5	0.042
17x29x41.5	0.048
19x32x41.5	0.054
20x39.5x41.5	0.065
24x45.5x41.5	0.080
28x38x41.5	0.076
31x46x41.5	0.092
35x50x41.5	0.106
40x55x41.5	0.123
25x45x57	0.102
30x45x57	0.113
35x50x57	0.132
45x55x57	0.164
45x65x57	0.184

For further details and graphs please refer to Technical Information.

**Dissipation factors** at +20° C:  $\tan \delta \times 10^{-4}$

PCM	400 VDC		500 VDC		600 VDC		800 VDC		900 VDC		1100 VDC		1300 VDC		1500 VDC	
	1 kHz	10 kHz	1 kHz	10 kHz	1 kHz	10 kHz	1 kHz	10 kHz	1 kHz	10 kHz	1 kHz	10 kHz	1 kHz	10 kHz	1 kHz	10 kHz
27.5	15	160	15	130	12	120	10	90	10	80	10	60	7	50	7	40
37.5	60	350	30	240	21	150	18	170	16	150	14	100	12	90	12	90
52.5	80	550	80	460	40	300	35	250	31	200	30	170	23	150	23	150

**Maximum pulse rise time:**

PCM	max. pulse rise time V/µsec at T <sub>A</sub> < 40° C							
	400 VDC	500 VDC	600 VDC	800 VDC	900 VDC	1100 VDC	1300 VDC	1500 VDC
27.5	11	15	27	29	35	43	50	59
37.5	8	10	19	21	22	29	35	41
52.5	5	7	13	15	18	21	25	29

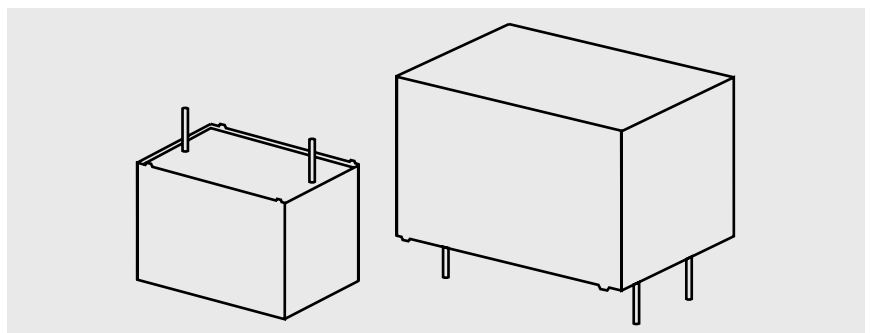

## Continuation

### General Data

Capacitance	400 VDC (70° C) / 300 VDC (85° C) / 220 VDC (105° C)								
	W	H	L	PCM**	Pin	I <sub>S</sub> A	I <sub>rms</sub> * (10 kHz)* A	ESR (10 kHz)* mΩ	Part number
1 μF	9	19	31.5	27.5	2	11	1	238.7	DCP4G041006A
2 "	9	19	31.5	27.5	2	22	1.5	119.4	DCP4G042006A
3 "	9	19	31.5	27.5	2	33	1.5	79.6	DCP4G043006A
4 "	9	19	31.5	27.5	2	44	2	59.7	DCP4G044006A
5 "	9	19	31.5	27.5	2	55	2	47.7	DCP4G045006A
7 "	9	19	31.5	27.5	2	77	2.5	34.1	DCP4G047006A
10 μF	11	21	31.5	27.5	2/4	110	3.5	23.9	DCP4G051006B
15 "	13	24	31.5	27.5	2/4	165	4.5	15.9	DCP4G051506D
20 "	15	26	31.5	27.5	2/4	220	5.5	11.9	DCP4G052006F
22 "	17	29	31.5	27.5	2/4	242	6	9.8	DCP4G052206G
25 "	17	29	31.5	27.5	2/4	275	7	8.6	DCP4G052506G
30 "	15	26	41.5	37.5	2/4	200	6.5	10	DCP4G052507D
30 "	17	34.5	31.5	27.5	2/4	330	8	7.2	DCP4G053006I
30 "	17	29	41.5	37.5	2/4	240	7.5	8.5	DCP4G053007E
40 "	20	39.5	31.5	27.5	2/4	440	10	5.4	DCP4G054006J
40 "	19	32	41.5	37.5	2/4	320	9.5	6	DCP4G054007F
50 "	20	39.5	41.5	37.5	2/4	400	11	5.4	DCP4G055007G
60 "	20	39.5	41.5	37.5	2/4	480	11.5	4.8	DCP4G056007G
70 "	24	45.5	41.5	37.5	2/4	560	13	4.7	DCP4G057007H
80 "	24	45.5	41.5	37.5	2/4	640	14	4.1	DCP4G058007H
90 "	24	45.5	41.5	37.5	2/4	720	15	3.6	DCP4G059007H
90 "	28	38	41.5	37.5	2/4	720	15	3.6	DCP4G059007L
100 μF	31	46	41.5	37.5	2/4	800	18	2.8	DCP4G061007I
120 "	31	46	41.5	37.5	2/4	960	20	2.3	DCP4G061207I
140 "	35	50	41.5	37.5	2/4	1120	22.5	2.1	DCP4G061407J
150 "	35	50	41.5	37.5	2/4	1200	23	2	DCP4G061507J
160 "	25	45	57	52.5	4	750	20	2.6	DCP4G061509D
160 "	40	55	41.5	37.5	2/4	1280	24.5	2	DCP4G061607K
160 "	25	45	57	52.5	4	800	21	2.3	DCP4G061609D
180 "	40	55	41.5	37.5	2/4	1440	26	1.8	DCP4G061807K
180 "	30	45	57	52.5	4	900	23.5	2	DCP4G061809E
200 "	40	55	41.5	37.5	2/4	1600	27.5	1.6	DCP4G062007K
200 "	30	45	57	52.5	4	1000	25	1.8	DCP4G062009E
220 "	35	50	57	52.5	4	1100	27	1.8	DCP4G062209F
250 "	45	55	57	52.5	4	1250	32	1.6	DCP4G062509H
270 "	45	55	57	52.5	4	1350	33.5	1.5	DCP4G062709H
300 "	45	55	57	52.5	4	1500	35	1.3	DCP4G063009H
330 "	45	65	57	52.5	4	1650	37	1.2	DCP4G063309J
350 "	45	65	57	52.5	4	1750	40	1.1	DCP4G063509J
370 "	45	65	57	52.5	4	1850	41.5	1.1	DCP4G063709J
400 "	45	65	57	52.5	4	2000	43	1	DCP4G064009J

\* General guide

New values and box sizes. The box sizes according to main catalogue 2019 are still available on request.

\* Permissible I<sub>rms</sub> at 10° C internal temperature rise (general guide)

\*\* PCM = Printed circuit module = pin spacing

Dims. in mm.

Part number completion:

Version code:	2-pin	= D2
	4-pin	= D4
Tolerance:	20 %	= M
	10 %	= K
	5 %	= J
Packing:	bulk	= S
Pin length:	6-2	= SD
Taped version see page 161.		

Rights reserved to amend design data without prior notification.

Continuation page 135

## Continuation

### General Data

Capacitance	500 VDC (70° C) / 400 VDC (85° C) / 290 VDC (105° C)								Part number
	W	H	L	PCM**	Pin	I <sub>s</sub> A	I <sub>rms</sub> * (10 kHz)* A	ESR (10 kHz)* mΩ	
1 μF	9	19	31.5	27.5	2	15	1	238.7	DCP4H141006A
2 "	9	19	31.5	27.5	2	30	1.5	119.4	DCP4H142006A
3 "	9	19	31.5	27.5	2	45	1.5	79.6	DCP4H143006A
4 "	9	19	31.5	27.5	2	60	1.8	63.7	DCP4H144006A
5 "	9	19	31.5	27.5	2	75	2.5	47.7	DCP4H145006A
7 "	11	21	31.5	27.5	2/4	105	3	34.1	DCP4H147006B
8 "	13	24	31.5	27.5	2/4	120	3	29.8	DCP4H148006D
10 μF	13	24	31.5	27.5	2/4	150	4	23.9	DCP4H151006D
12 "	15	26	31.5	27.5	2/4	180	4	19.9	DCP4H151206F
15 "	17	29	31.5	27.5	2/4	225	5	15.9	DCP4H151506G
	15	26	41.5	37.5	2/4	150	4.3	22.3	DCP4H151507D
18 "	17	29	31.5	27.5	2/4	270	6	9.5	DCP4H151806G
20 "	17	34.5	31.5	27.5	2/4	300	6	11.9	DCP4H152006I
	17	29	41.5	37.5	2/4	200	5.4	16.8	DCP4H152007E
22 "	20	39.5	31.5	27.5	2/4	330	7	10.9	DCP4H152206J
25 "	20	39.5	31.5	27.5	2/4	375	7.5	9.5	DCP4H152506J
	19	32	41.5	37.5	2/4	250	6.3	13.4	DCP4H152507F
30 "	20	39.5	41.5	37.5	2/4	300	9	7.9	DCP4H153007G
35 "	20	39.5	41.5	37.5	2/4	350	8.5	9.1	DCP4H153507G
40 "	20	39.5	41.5	37.5	2/4	400	10	5.7	DCP4H154007G
50 "	24	45.5	41.5	37.5	2/4	500	13	4.8	DCP4H155007H
	28	38	41.5	37.5	2/4	500	13	4.8	DCP4H155007L
55 "	24	45.5	41.5	37.5	2/4	550	14	4	DCP4H155507H
	28	38	41.5	37.5	2/4	550	14	4	DCP4H155507L
60 "	31	46	41.5	37.5	2/4	600	14	4.7	DCP4H156007I
70 "	31	46	41.5	37.5	2/4	700	16.5	3.9	DCP4H157007I
80 "	31	46	41.5	37.5	2/4	800	17.5	3.4	DCP4H158007I
90 "	35	50	41.5	37.5	2/4	900	19	3	DCP4H159007J
100 μF	35	50	41.5	37.5	2/4	1000	20	2.7	DCP4H161007J
	25	45	57	52.5	4	700	14.3	5	DCP4H161009D
120 "	40	55	41.5	37.5	2/4	1200	22.5	2.7	DCP4H161207K
	30	45	57	52.5	4	840	16.5	4.2	DCP4H161209E
130 "	40	55	41.5	37.5	2/4	1300	23	2.4	DCP4H161307K
140 "	35	50	57	52.5	4	980	21.5	2.8	DCP4H161409F
150 "	35	50	57	52.5	4	1050	22.5	2.7	DCP4H161509F
160 "	45	55	57	52.5	4	1120	25.5	2.5	DCP4H161609H
180 "	45	55	57	52.5	4	1260	27	2.2	DCP4H161809H
200 "	45	55	57	52.5	4	1400	28.5	2	DCP4H162009H
210 "	45	55	57	52.5	4	1470	29.5	1.9	DCP4H162109H
220 "	45	65	57	52.5	4	1540	32	1.8	DCP4H162209J
240 "	45	65	57	52.5	4	1680	33.5	1.7	DCP4H162409J

\* General guide

New values and box sizes. The box sizes according to main catalogue 2019 are still available on request.

\* Permissible I<sub>rms</sub> at 10° C internal temperature rise (general guide)

\*\* PCM = Printed circuit module = pin spacing

Dims. in mm.

Rights reserved to amend design data without prior notification.

Part number completion:

Version code:	2-pin	= D2
	4-pin	= D4
Tolerance:	20 %	= M
	10 %	= K
	5 %	= J
Packing:	bulk	= S
Pin length:	6-2	= SD
Taped version see page 161.		

Continuation page 136

## Continuation

### General Data

Capacitance	600 VDC (70° C) / 450 VDC (85° C) / 320 VDC (105° C)								
	W	H	L	PCM**	Pin	I <sub>S</sub> A	I <sub>rms</sub> * (10 kHz)* A	ESR (10 kHz)* mΩ	Part number
1 μF	9	19	31.5	27.5	2	27	1.5	106.9	DCP41041006A
2 "	9	19	31.5	27.5	2	54	2	56	DCP41042006A
3 "	9	19	31.5	27.5	2	81	2.5	35.6	DCP41043006A
4 "	11	21	31.5	27.5	2/4	108	3	26.7	DCP41044006B
5 "	13	24	31.5	27.5	2/4	135	3.5	22	DCP41045006D
7 "	15	26	31.5	27.5	2/4	189	4.5	16	DCP41047006F
8 "	15	26	31.5	27.5	2/4	216	5	13.4	DCP41048006F
10 μF	17	29	31.5	27.5	2/4	270	6	11	DCP41051006G
	13	24	41.5	37.5	2/4	190	5	17.6	DCP41051007C
12 "	17	29	31.5	27.5	2/4	324	6.5	8.9	DCP41051206G
15 "	17	34.5	31.5	27.5	2/4	405	8	7	DCP41051506I
	17	29	41.5	37.5	2/4	285	6.5	11.8	DCP41051507E
18 "	20	39.5	31.5	27.5	2/2	486	9.5	5.9	DCP41051806J
20 "	20	39.5	31.5	27.5	2/4	540	10	5.3	DCP41052006J
	19	32	41.5	37.5	2/4	380	10.5	4.9	DCP41052007F
22 "	20	39.5	41.5	37.5	2/4	418	11	5.4	DCP41052207G
25 "	20	39.5	41.5	37.5	2/4	475	11.5	5	DCP41052507G
30 "	24	45.5	41.5	37.5	2/4	570	14	4.1	DCP41053007H
35 "	24	45.5	41.5	37.5	2/4	665	14.5	3.8	DCP41053507H
	28	38	41.5	37.5	2/4	665	14.5	3.8	DCP41053507L
40 "	31	46	41.5	37.5	2/4	760	16.5	3.3	DCP41054007I
45 "	31	46	41.5	37.5	2/4	855	17	3.2	DCP41054507I
50 "	35	50	41.5	37.5	2/4	950	19	2.9	DCP41055007J
60 "	35	50	41.5	37.5	2/4	1140	17.5	3.4	DCP41056007J
	25	45	57	52.5	2/4	780	14.5	4.9	DCP41056009D
70 "	40	55	41.5	37.5	2/4	1330	20	3.1	DCP41057007K
	30	45	57	52.5	4	910	16.5	4.2	DCP41057009E
80 "	40	55	41.5	37.5	2/4	1520	22	2.6	DCP41058007K
	30	45	57	52.5	4	1040	17.8	3.6	DCP41058009E
90 "	35	50	57	52.5	4	1170	23.5	1.9	DCP41059009F
100 μF	45	55	57	52.5	4	1300	25	2.6	DCP41061009H
120 "	45	65	57	52.5	4	1560	28	2.3	DCP41061209J
140 "	45	65	57	52.5	4	1820	31	1.9	DCP41061409J
150 "	45	65	57	52.5	4	1950	33	1.7	DCP41061509J

\* General guide

New values and box sizes. The box sizes according to main catalogue 2019 are still available on request.

\* Permissible I<sub>rms</sub> at 10° C internal temperature rise (general guide)

\*\* PCM = Printed circuit module = pin spacing

Dims. in mm.

Part number completion:	
Version code:	2-pin = D2
	4-pin = D4
Tolerance:	20 % = M
	10 % = K
	5 % = J
Packing:	bulk = S
Pin length:	6-2 = SD
Taped version see page 161.	

#### 2-pin version

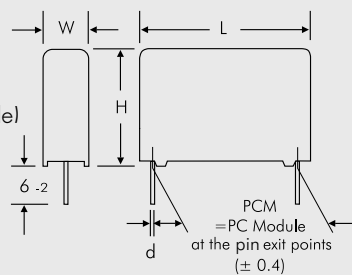

PCM	d
27.5	0.8
37.5	1

#### 4-pin version

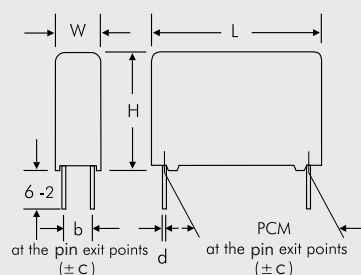

W	PCM	b	d	c
11	27.5	5	0.8	0.4
13	27.5	7.5	0.8	0.4
15	27.5	7.5	0.8	0.4
17	27.5	10	0.8	0.4
20	27.5	12.5	0.8	0.4
19	37.5	10	1	0.4
20	37.5	12.5	1	0.4
24	37.5	12.5	1	0.4
28	37.5	10	1	0.4
31	37.5	20	1	0.4
35	37.5	20	1	0.4
40	37.5	20	1	0.4
25	52.5	20	1.2	0.8
30	52.5	20	1.2	0.8
35	52.5	20	1.2	0.8
45	52.5	20	1.2	0.8

Rights reserved to amend design data without prior notification.

## Continuation

### General Data

Capacitance	800 VDC (70° C) / 700 VDC (85° C) / 510 VDC (105° C)								Part number
	W	H	L	PCM**	Pin	$I_S$ A	$I_{rms}^*$ (10 kHz)* A	ESR (10 kHz)* mΩ	
1 μF	9	19	31.5	27.5	2	29	1.7	73.2	DCP4L041006A
2 "	9	19	31.5	27.5	2	58	2.5	36.6	DCP4L042006A
3 "	11	21	31.5	27.5	2/4	87	3	24.4	DCP4L043006B
4 "	13	24	31.5	27.5	2/4	116	4	18.3	DCP4L044006D
5 "	13	24	31.5	27.5	2/4	145	4.5	14.6	DCP4L045006D
7 "	17	29	31.5	27.5	2/4	203	6	10.5	DCP4L047006G
8 "	17	29	31.5	27.5	2/4	232	6.5	9.2	DCP4L048006G
10 μF	17	34.5	31.5	27.5	2/4	290	8	7.3	DCP4L051006I
	17	29	41.5	37.5	2/4	210	7.5	8.5	DCP4L051007E
12 "	20	39.5	31.5	27.5	2/4	348	9.5	6.1	DCP4L051206J
15 "	20	39.5	31.5	27.5	2/4	435	10.5	4.9	DCP4L051506J
	19	32	41.5	37.5	2/4	315	8.5	7.5	DCP4L051507F
18 "	20	39.5	41.5	37.5	2/4	378	9.5	7.2	DCP4L051807G
20 "	20	39.5	41.5	37.5	2/4	420	10	6.2	DCP4L052007G
22 "	20	39.5	41.5	37.5	2/4	462	10.5	5.9	DCP4L052207G
25 "	24	45.5	41.5	37.5	2/4	525	12.5	5	DCP4L052507H
30 "	24	45.5	41.5	37.5	2/4	630	14	4.1	DCP4L053007H
	28	38	41.5	37.5	2/4	630	14	4.1	DCP4L053007L
35 "	31	46	41.5	37.5	2/4	735	15.5	3.8	DCP4L053507I
40 "	31	46	41.5	37.5	2/4	840	16.5	3.3	DCP4L054007I
45 "	35	50	41.5	37.5	2/4	945	17.5	3.4	DCP4L054507J
50 "	35	50	41.5	37.5	2/4	1050	19	3	DCP4L055007J
	25	45	57	52.5	4	750	18.5	3	DCP4L055009D
60 "	40	55	41.5	37.5	2/4	1260	21.5	2.7	DCP4L056007K
	30	45	57	52.5	4	900	20.5	2.7	DCP4L056009E
65 "	35	50	57	52.5	4	975	22.5	2.2	DCP4L056509F
70 "	45	55	57	52.5	4	1050	23.5	3	DCP4L057009H
75 "	45	55	57	52.5	4	1125	24	2.9	DCP4L057509H
80 "	45	55	57	52.5	4	1200	24.5	3	DCP4L058009H
90 "	45	65	57	52.5	4	1350	25.5	2.5	DCP4L059009J
100 μF	45	65	57	52.5	4	1500	26.5	2.3	DCP4L061009J
115 "	45	65	57	52.5	4	1725	28	2.1	DCP4L061159J

\* General guide

New values and box sizes. The box sizes according to main catalogue 2019 are still available on request.

\* Permissible  $I_{rms}$  at 10° C internal temperature rise (general guide)

\*\* PCM = Printed circuit module = pin spacing

Dims. in mm.

Part number completion:	
Version code:	2-pin = D2 4-pin = D4
Tolerance:	20 % = M 10 % = K 5 % = J
Packing:	bulk = S
Pin length:	6-2 = SD
Taped version see page 161.	

#### 2-pin version

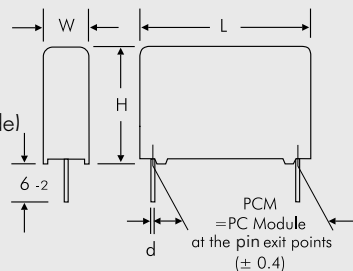

PCM	d
27.5	0.8
37.5	1

#### 4-pin version

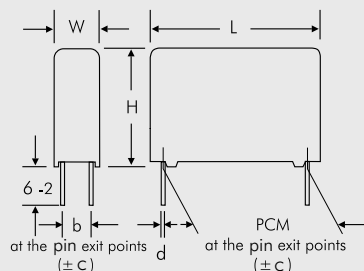

W	PCM	b	d	c
11	27.5	5	0.8	0.4
13	27.5	7.5	0.8	0.4
15	27.5	7.5	0.8	0.4
17	27.5	10	0.8	0.4
20	27.5	12.5	0.8	0.4
19	37.5	10	1	0.4
20	37.5	12.5	1	0.4
24	37.5	12.5	1	0.4
28	37.5	10	1	0.4
31	37.5	20	1	0.4
35	37.5	20	1	0.4
40	37.5	20	1	0.4
25	52.5	20	1.2	0.8
30	52.5	20	1.2	0.8
35	52.5	20	1.2	0.8
45	52.5	20	1.2	0.8

Rights reserved to amend design data without prior notification..

## Continuation

### General Data

Capacitance	900 VDC (70° C) / 760 VDC (85° C) / 550 VDC (105° C)								Part number
	W	H	L	PCM**	Pin	I <sub>s</sub> A	I <sub>rms</sub> * (10 kHz)* A	ESR (10 kHz)* mΩ	
1 μF	9	19	31.5	27.5	2	35	2	66.1	DCP4N041006A_____
2 "	11	21	31.5	27.5	2/4	70	2.5	44	DCP4N042006B_____
3 "	13	24	31.5	27.5	2/4	105	4	22	DCP4N043006D_____
4 "	13	24	31.5	27.5	2/4	140	4.5	16.5	DCP4N044006D_____
5 "	17	29	31.5	27.5	2/4	175	4.5	18	DCP4N045006G_____
7 "	17	29	31.5	27.5	2/4	245	6.5	9.4	DCP4N047006G_____
8 "	17	34.5	31.5	27.5	2/4	280	7.5	8.3	DCP4N048006I_____
10 μF	20	39.5	31.5	27.5	2/4	350	10	5.3	DCP4N051006J_____
	19	32	41.5	37.5	2/4	220	9	6.7	DCP4N051007F_____
15 "	20	39.5	41.5	37.5	2/4	330	10.5	5.8	DCP4N051507G_____
20 "	24	45.5	41.5	37.5	2/4	440	13	4.8	DCP4N052007H_____
22 "	28	38	41.5	37.5	2/4	440	13	4.8	DCP4N052007L_____
	24	45.5	41.5	37.5	2/4	484	14	4.1	DCP4N052207H_____
	28	38	41.5	37.5	2/4	484	14	4.1	DCP4N052207L_____
25 "	31	46	41.5	37.5	2/4	550	15.5	3.8	DCP4N052507I_____
30 "	31	46	41.5	37.5	2/4	660	16.5	3.4	DCP4N053007I_____
	25	45	57	52.5	4	540	15	4.5	DCP4N053009D_____
35 "	35	50	41.5	37.5	2/4	770	18	3.2	DCP4N053507J_____
	25	45	57	52.5	4	630	16	4	DCP4N053509D_____
40 "	40	55	41.5	37.5	2/4	880	19.5	3.2	DCP4N054007K_____
	30	45	57	52.5	4	720	18	3.5	DCP4N054009E_____
50 "	35	50	57	52.5	4	900	22	3.3	DCP4N055009F_____
60 "	45	55	57	52.5	4	1080	23	3	DCP4N056009H_____
70 "	45	65	57	52.5	4	1260	24.5	3.3	DCP4N057009J_____
80 "	45	65	57	52.5	4	1440	25.5	2.8	DCP4N058009J_____

\* General guide

■ New values and box sizes. The box sizes according to main catalogue 2019 are still available on request.

\* Permissible I<sub>rms</sub> at 10° C internal temperature rise (general guide)

\*\* PCM = Printed circuit module = pin spacing

Dims. in mm.

Part number completion:	
Version code:	2-pin = D2 4-pin = D4
Tolerance:	20 % = M 10 % = K 5 % = J
Packing:	bulk = S
Pin length:	6-2 = SD
Taped version see page 161.	

Rights reserved to amend design data without prior notification.

Continuation page 139

## Continuation

### General Data

Capacitance	1100 VDC (70° C) / 920 VDC (85° C) / 670 VDC (105° C)								
	W	H	L	PCM**	Pin	I <sub>S</sub> A	I <sub>rms</sub> * (10 kHz)* A	ESR (10 kHz)* mΩ	Part number
1 μF	9	19	31.5	27.5	2	43	2	86	DCP4P041006A
2 "	13	24	31.5	27.5	2/4	86	4	19	DCP4P042006D
3 "	15	26	31.5	27.5	2/4	129	5	13.6	DCP4P043006F
4 "	17	29	31.5	27.5	2/4	172	6	10.8	DCP4P044006G
5 "	17	34.5	31.5	27.5	2/4	215	7.5	7.8	DCP4P045006I
7 "	20	39.5	31.5	27.5	2/4	301	9	6.5	DCP4P047006J
	19	32	41.5	37.5	2/4	203	7.5	10	DCP4P047007F
8 "	20	39.5	41.5	37.5	2/4	232	8	10	DCP4P048007G
10 μF	20	39.5	41.5	37.5	2/4	290	9.5	7.2	DCP4P051007G
12 "	24	45.5	41.5	37.5	2/4	348	11	6.6	DCP4P051207H
15 "	24	45.5	41.5	37.5	2/4	435	12	5.6	DCP4P051507H
	28	38	41.5	37.5	2/4	435	12	5.6	DCP4P051507L
18 "	31	46	41.5	37.5	2/4	522	13.5	5	DCP4P051807I
20 "	35	50	41.5	37.5	2/4	580	15	4.7	DCP4P052007J
	25	45	57	52.5	4	420	14.5	4.9	DCP4P052009D
22 "	35	50	41.5	37.5	2/4	638	15.5	4.4	DCP4P052207J
	25	45	57	52.5	4	462	15	4.5	DCP4P052209D
25 "	40	55	41.5	37.5	2/4	725	16.5	4.6	DCP4P052507K
	30	45	57	52.5	4	525	16	4.4	DCP4P052509E
30 "	35	50	57	52.5	4	630	17.5	4.4	DCP4P053009F
35 "	35	50	57	52.5	4	735	18	4	DCP4P053509F
40 "	35	50	57	52.5	4	840	18	4.3	DCP4P054009F
45 "	45	55	57	52.5	4	945	20	4.1	DCP4P054509H
50 "	45	65	57	52.5	4	1050	21	4.1	DCP4P055009J
60 "	45	65	57	52.5	4	1260	23	3.5	DCP4P056009J

Capacitance	1300 VDC (70° C) / 1100 VDC (85° C) / 800 VDC (105° C)								
	W	H	L	PCM**	Pin	I <sub>S</sub> A	I <sub>rms</sub> * (10 kHz)* A	ESR (10 kHz)* mΩ	Part number
1 μF	11	21	31.5	27.5	2/4	50	2.5	40	DCP4R241006B
2 "	15	26	31.5	27.5	2/4	100	4.5	16.8	DCP4R242006F
3 "	17	29	31.5	27.5	2/4	150	6	10.8	DCP4R243006G
4 "	17	34.5	31.5	27.5	2/4	200	6.5	10.4	DCP4R244006I
5 "	20	39.5	31.5	27.5	2/4	250	7.5	9.4	DCP4R245006J
	19	32	41.5	37.5	2/4	175	7	11	DCP4R245007F
7 "	20	39.5	41.5	37.5	2/4	245	8	10	DCP4R247007G
8 "	24	45.5	41.5	37.5	2/4	280	9	9.9	DCP4R248007H
10 μF	24	45.5	41.5	37.5	2/4	350	10.5	7.2	DCP4R251007H
	28	38	41.5	37.5	2/4	350	10.5	7.2	DCP4R251007L
15 "	31	46	41.5	37.5	2/4	525	14	4.8	DCP4R251507I
	25	45	57	52.5	4	375	13	6	DCP4R251509D
18 "	35	50	41.5	37.5	2/4	630	15.5	4.4	DCP4R251807J
	25	45	57	52.5	4	450	14.5	4.9	DCP4R251809D
20 "	40	55	41.5	37.5	2/4	700	17.5	4	DCP4R252007K
	30	45	57	52.5	4	500	16	4.4	DCP4R252009E
22 "	40	55	41.5	37.5	2/4	770	18	3.8	DCP4R252207K
	35	50	57	52.5	4	550	17.5	4.3	DCP4R252209F
25 "	35	50	57	52.5	4	625	19	3.6	DCP4R252509F
30 "	45	55	57	52.5	4	750	20	4	DCP4R253009H
35 "	45	65	57	52.5	4	875	21	4.1	DCP4R253509J
40 "	45	65	57	52.5	4	1000	22	3.7	DCP4R254009J

\* General guide

■ New values and box sizes. The box sizes according to main catalogue 2019 are still available on request.

\*\* PCM = Printed circuit module = pin spacing

\* Permissible I<sub>rms</sub> at 10° C internal temperature rise (general guide)

Dims. in mm.

Rights reserved to amend design data without prior notification.

## Continuation

### General Data

Capacitance	1500 VDC (70° C) / 1200 VDC (85° C) / 870 VDC (105° C)								
	W	H	L	PCM**	Pin	$I_s$ A	$I_{rms}$ * (10 kHz)* A	ESR (10 kHz)* mΩ	Part number
1 μF	13	24	31.5	27.5	2/4	59	3	33.3	DCP4S041006D_____
2 "	17	29	31.5	27.5	2/4	118	5	15.6	DCP4S042006G_____
3 "	19	32	41.5	37.5	2/4	123	6	15	DCP4S043007F_____
4 "	20	39.5	41.5	37.5	2/4	164	7	13.3	DCP4S044007G_____
5 "	20	39.5	41.5	37.5	2/4	205	8	10.2	DCP4S045007G_____
7 "	24	45.5	41.5	37.5	2/4	287	9.5	8.9	DCP4S047007H_____
	28	38	41.5	37.5	2/4	287	9.5	8.4	DCP4S047007L_____
8 "	31	46	41.5	37.5	2/4	328	11	7.6	DCP4S048007I_____
10 μF	31	46	41.5	37.5	2/4	410	12.5	5.9	DCP4S051007I_____
12 "	35	50	41.5	37.5	2/4	492	14.5	5	DCP4S051207J_____
	25	45	57	52.5	4	348	14	5.2	DCP4S051209D_____
15 "	40	55	41.5	37.5	2/4	615	17	4.3	DCP4S051507K_____
	30	45	57	52.5	4	435	16	4.4	DCP4S051509E_____
18 "	35	50	57	52.5	4	522	17.5	4.3	DCP4S051809F_____
20 "	35	50	57	52.5	4	580	18	4.1	DCP4S052009F_____
22 "	45	55	57	52.5	4	638	20	4.1	DCP4S052209H_____
25 "	45	55	57	52.5	4	725	20.5	3.9	DCP4S052509H_____
30 "	45	65	57	52.5	4	870	21.5	4	DCP4S053009J_____

\* General guide

New range

\* Permissible  $I_{rms}$  at 10° C internal temperature rise (general guide)

\*\* PCM = Printed circuit module = pin spacing

Dims. in mm.

Part number completion:	
Version code:	2-pin = D2 4-pin = D4
Tolerance:	20 % = M 10 % = K 5 % = J
Packing:	bulk = S
Pin length:	6-2 = SD
Taped version see page 161.	

#### 2-pin version

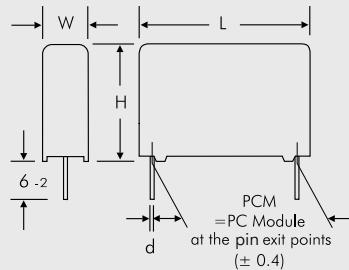

PCM	d
27.5	0.8
37.5	1

#### 4-pin version

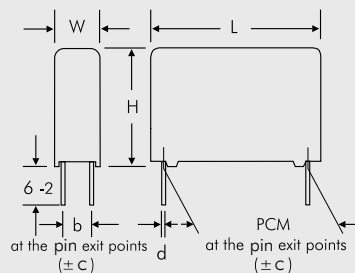

W	PCM	b	d	c
11	27.5	5	0.8	0.4
13	27.5	7.5	0.8	0.4
15	27.5	7.5	0.8	0.4
17	27.5	10	0.8	0.4
20	27.5	12.5	0.8	0.4
19	37.5	10	1	0.4
20	37.5	12.5	1	0.4
24	37.5	12.5	1	0.4
28	37.5	10	1	0.4
31	37.5	20	1	0.4
35	37.5	20	1	0.4
40	37.5	20	1	0.4
25	52.5	20	1.2	0.8
30	52.5	20	1.2	0.8
35	52.5	20	1.2	0.8
45	52.5	20	1.2	0.8

#### Plate versions page 144

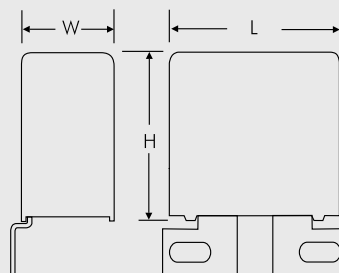

Example

Rights reserved to amend design data without prior notification.

Continuation page 141



## Continuation

### 500 VDC

Impedance change with frequency  
(general guide)

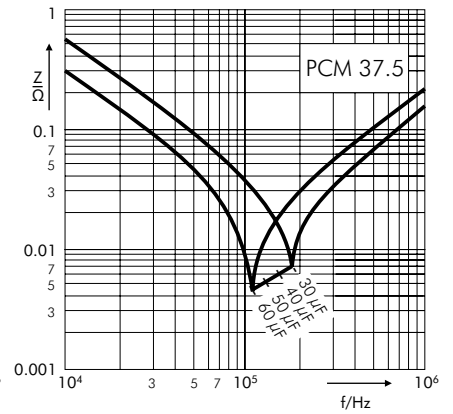
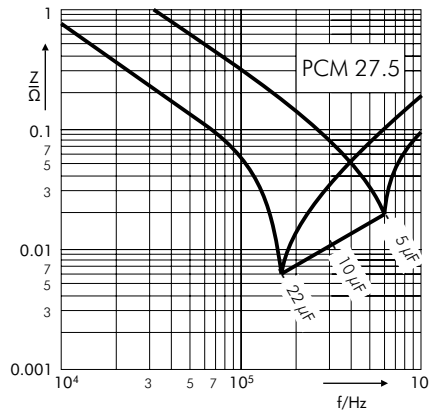

Permissible AC current in relation to frequency at  $\leq 20^\circ\text{C}$  internal temperature rise (general guide)

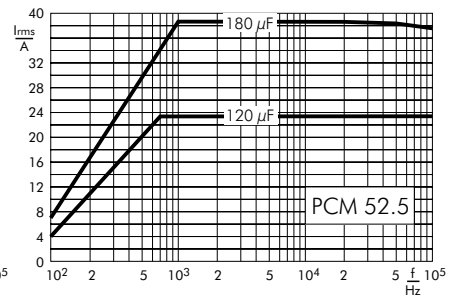
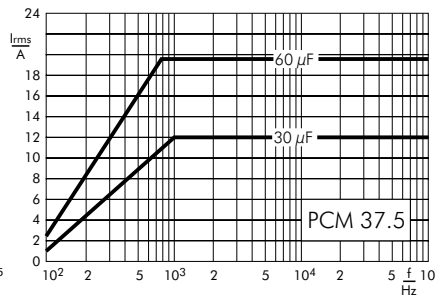
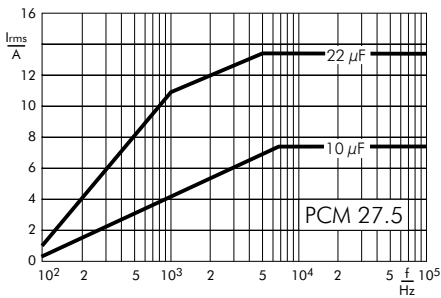

### 600 VDC

Impedance change with frequency  
(general guide)

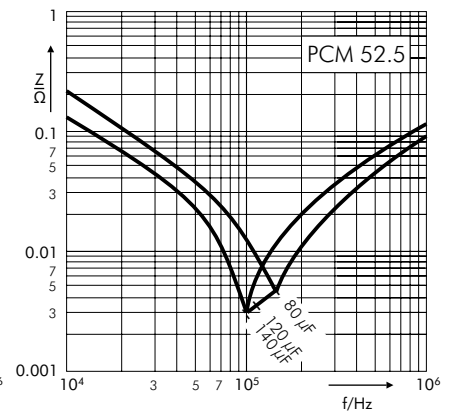
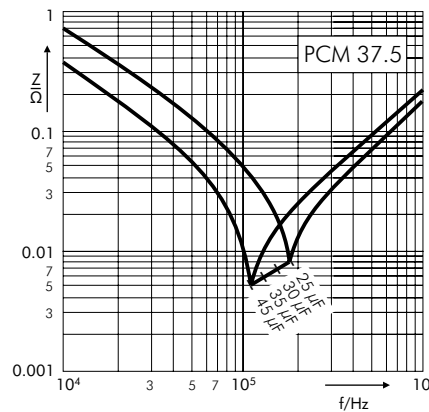

Permissible AC current in relation to frequency at  $\leq 20^\circ\text{C}$  internal temperature rise (general guide)

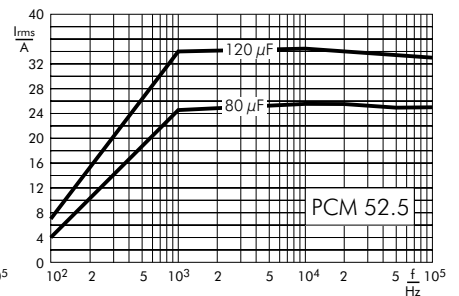
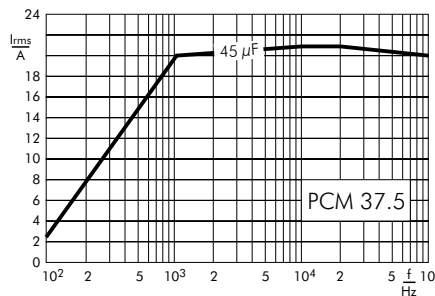

## Continuation

### 800 VDC

Impedance change with frequency (general guide)

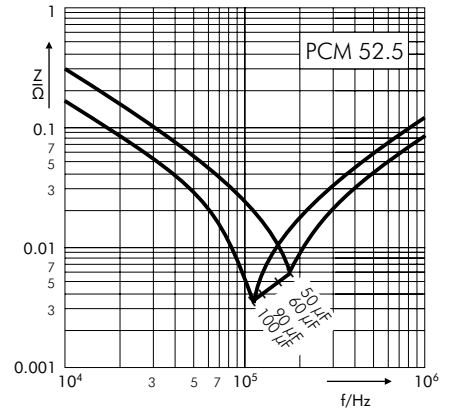
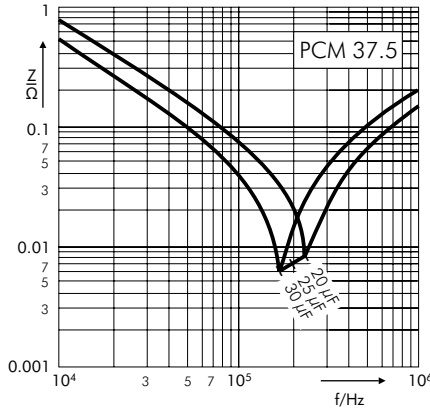
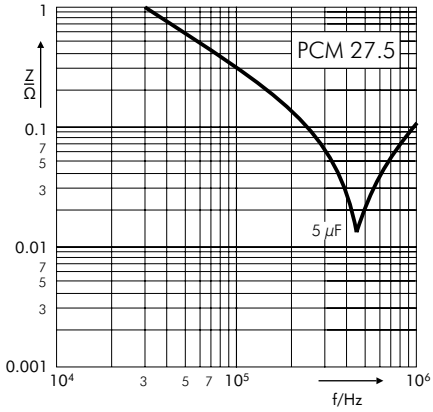

Permissible AC current in relation to frequency at  $\leq 20^\circ\text{C}$  internal temperature rise (general guide)

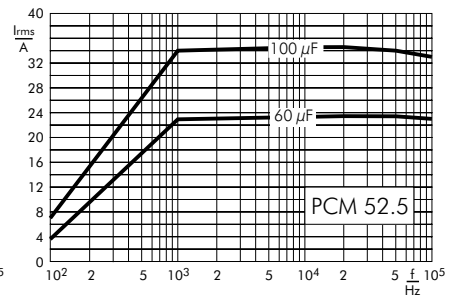
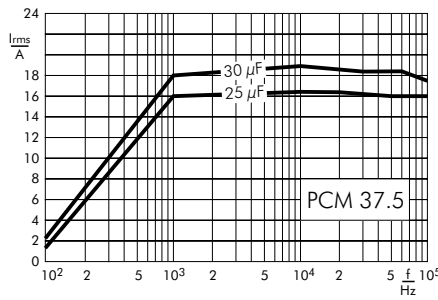
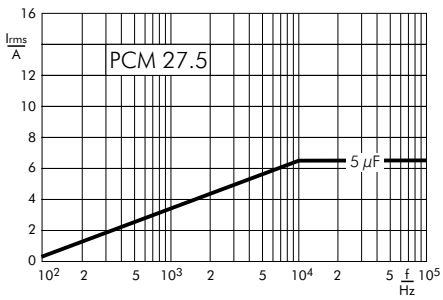

### 900 VDC

Impedance change with frequency (general guide)

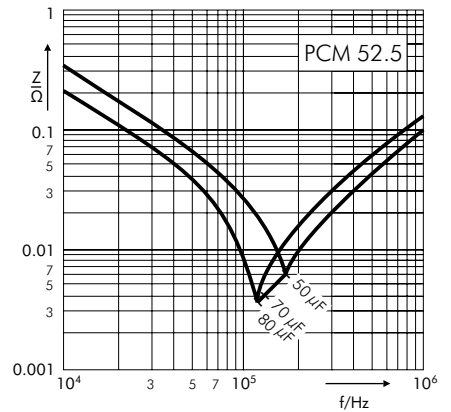
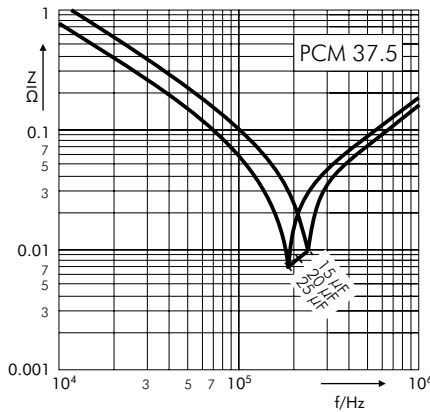

Permissible AC current in relation to frequency at  $\leq 20^\circ\text{C}$  internal temperature rise (general guide)

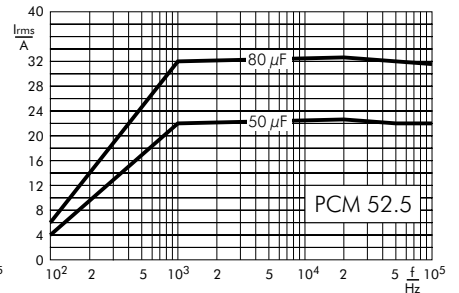
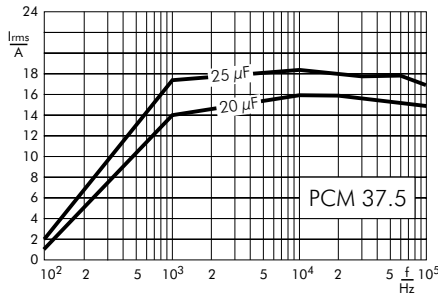

## Continuation

### 1100 VDC

Impedance change with frequency (general guide)

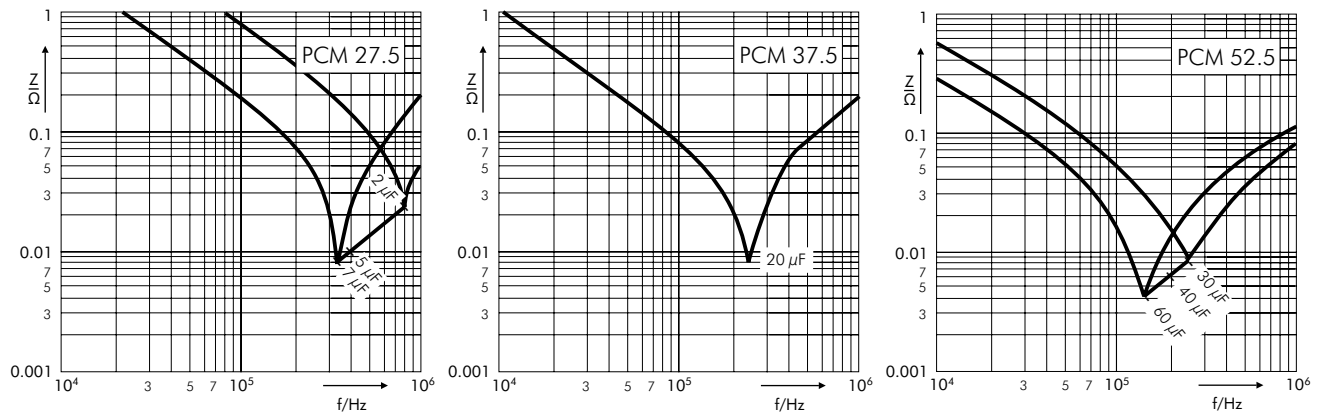

Permissible AC current in relation to frequency at  $\leq 20^\circ\text{C}$  internal temperature rise (general guide)

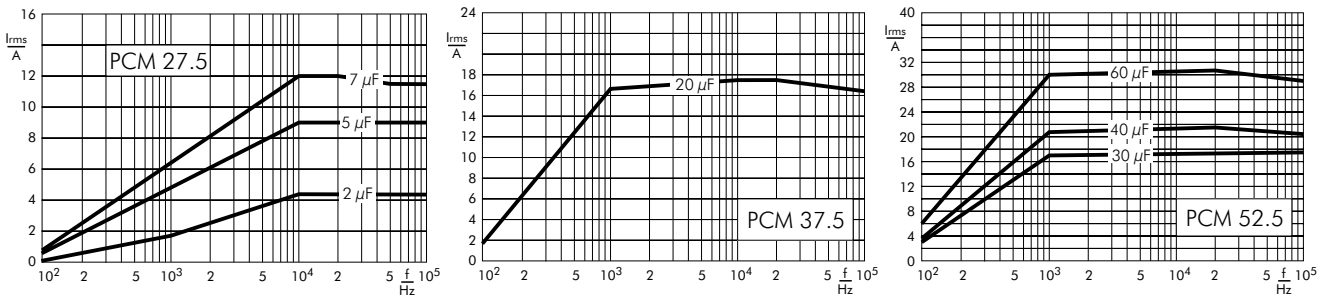

### 1300 VDC

Impedance change with frequency (general guide)

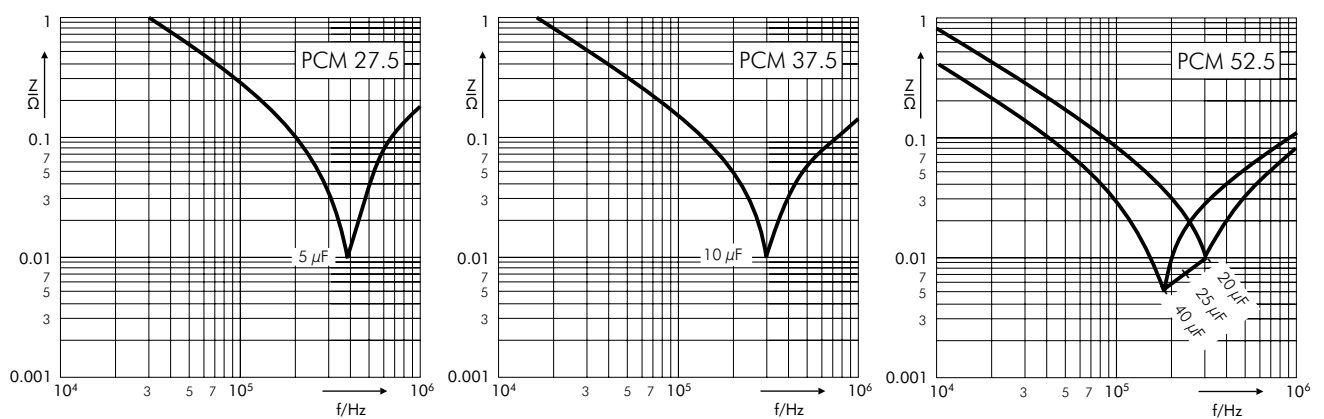

Permissible AC current in relation to frequency at  $\leq 20^\circ\text{C}$  internal temperature rise (general guide)

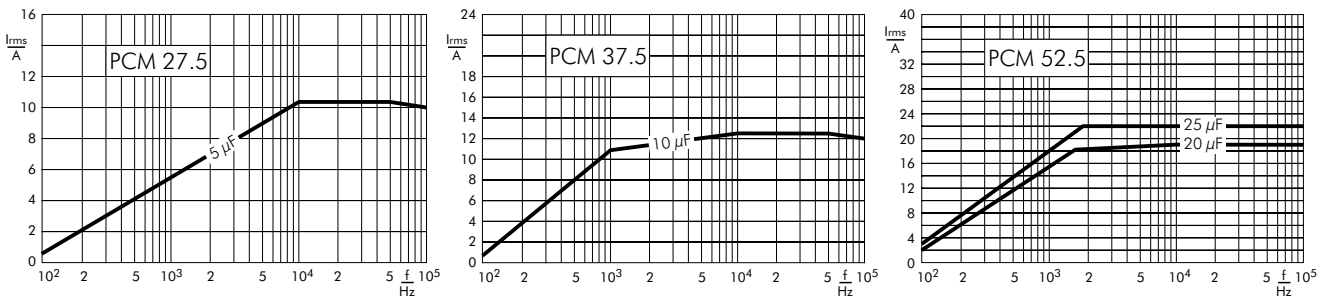

## Continuation

### Plate versions

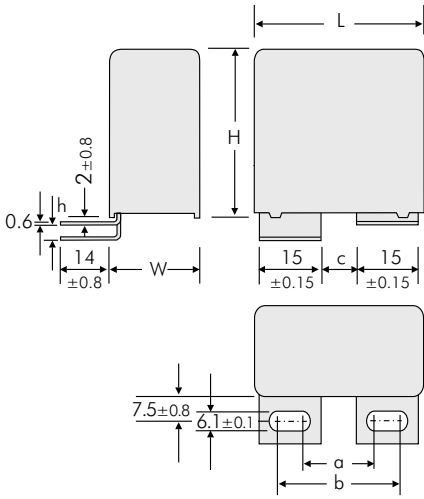

Version	L	a ±0.5	b ±0.5	c ±0.5	h ±0.8
<b>A1</b>	41.5	17.5	28	7.5	0
<b>A1.5</b>	41.5	17.5	28	7.5	3.5

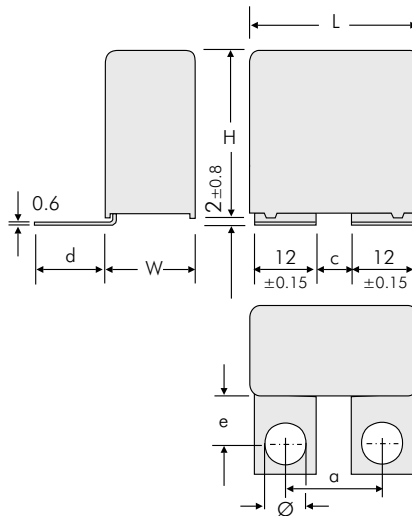

Version	L	a ±0.5	c ±0.5	d ±0.8	e ±0.8	Ø ±0.1
<b>A1.6</b>	41.5	18	6	21.5	16	7
<b>A1.6.1</b>	41.5	22	10	18.5	13	7
<b>A1.6.2</b>	41.5	23	10	18.5	13	8

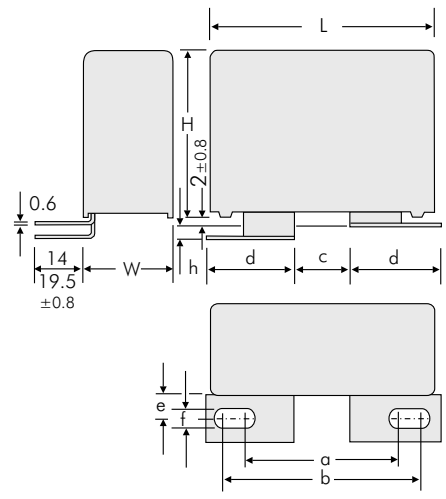

Version	L	a ±0.5	b ±0.5	c ±0.5	d ±0.15	e ±0.8	f ±0.1	h ±0.8
<b>A2</b>	41.5	36	46.5	14.5	22	7.5	8.4	0
<b>A2.4.1</b>	41.5	33.5	39.5	7.5	22	13	8.4	0
<b>A2.6.1</b>	41.5	31.5	41.5	14	22	13	6.1	3.5
<b>A2.6.2</b>	41.5	31.5	41.5	14	22	13	6.1	0
<b>A2.8</b>	41.5	36	46.5	14.5	22	7.5	8.4	3.5

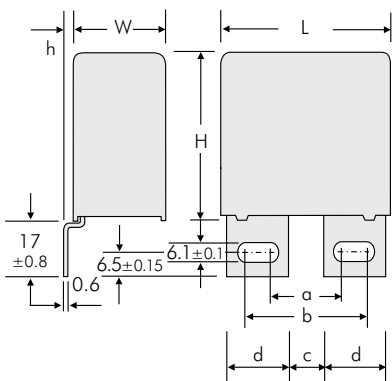

Version	L	a ±0.5	b ±0.5	c ±0.5	d ±0.15	h ±0.8
<b>A3</b>	41.5	17.5	27.5	7.5	15	0
<b>A3.5</b>	41.5	17.5	27.5	7.5	15	3
<b>A3.12</b>	41.5	17.5	30	7.5	16.5	0

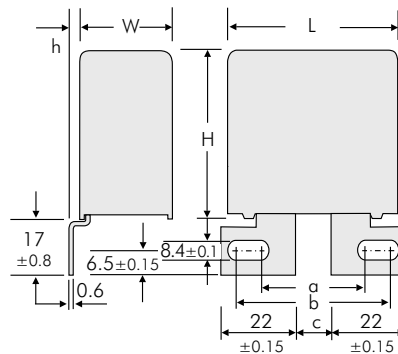

Version	L	a ±0.5	b ±0.5	c ±0.5	h ±0.8
<b>A3.9</b>	41.5	40.5	46.5	14.5	0
<b>A3.11</b>	41.5	40.5	46.5	14.5	3

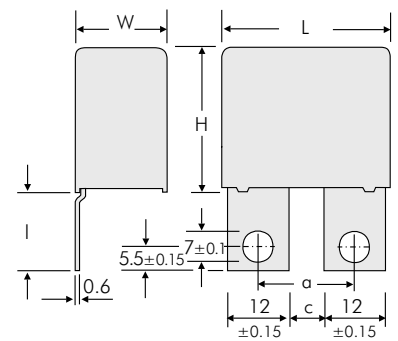

Version	L	a ±0.5	c ±0.5	l ±0.8
<b>A3.8</b>	41.5 W ≥ 17	18	6	23
<b>A3.8.1</b>	41.5 W ≥ 17	22	10	17.5
<b>A3.8.2</b>	41.5 W ≥ 17	22	10	23

## Continuation

### Plate versions

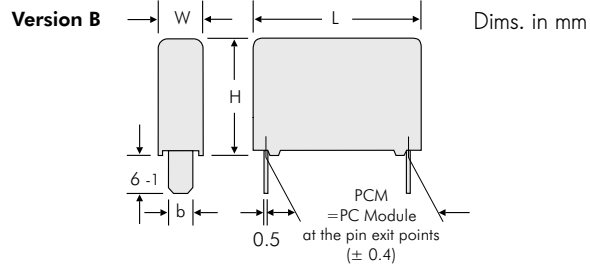
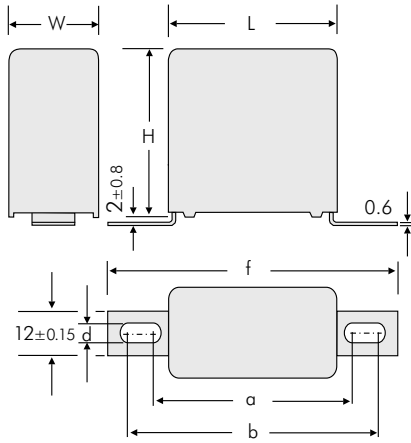

L	PCM	b ±0.15
31.5	28.5	8
41.5	38.5	8

Additional special versions can be realized. Please contact us with your specific needs.

Version	L	a ±0.8	b ±0.8	f ±0.8	d ±0.1
<b>A4.9</b>	31.5 W ≥ 15	44	47	57	4.5
<b>A4.10</b>	31.5 W ≥ 15	43	59	69	6.1
<b>A4.2</b>	41.5 W ≥ 15	54	57	67	4.5
<b>A4</b>	41.5 W ≥ 15	53	69	79	6.1

Possible connecting respective plate versions - depending on box size

Version code		D2	D4	B8	1A	1H	1I	1J	1S	2A	2F	2J	2K	2M	3A	3G	3K	3L	3M	3N	3P	3Q	4A	4C	4L	4M	
W x H x L	Size Code	2-pin	4-pin	B8	A1	A1.5	A1.6	A1.6.1	A1.6.2	A2	A2.4.1	A2.6.1	A2.6.2	A2.8	A3	A3.5	A3.8	A3.8.1	A3.8.2	A3.9	A3.11	A3.12	A4	A4.2	A4.9	A4.10	
9 x 19 x 31.5	<b>6A</b>																										
11 x 21 x 31.5	<b>6B</b>																										
13 x 24 x 31.5	<b>6D</b>																										
15 x 26 x 31.5	<b>6F</b>																										
17 x 29 x 31.5	<b>6G</b>																										
17 x 34.5 x 31.5	<b>6I</b>																										
20 x 39.5 x 31.5	<b>6J</b>																										
13 x 24 x 41.5	<b>7C</b>																										
15 x 26 x 41.5	<b>7D</b>																										
17 x 29 x 41.5	<b>7E</b>																										
19 x 32 x 41.5	<b>7F</b>																										
20 x 39.5 x 41.5	<b>7G</b>																										
24 x 45.5 x 41.5	<b>7H</b>																										
28 x 38 x 41.5	<b>7L</b>																										
31 x 46 x 41.5	<b>7I</b>																										
35 x 50 x 41.5	<b>7J</b>																										
40 x 55 x 41.5	<b>7K</b>																										

## Recommendation for Processing and Application of Through-Hole Capacitors

### Soldering Process

Internal temperature of the capacitor must be kept as follows:

Polyester: preheating:  $T_{max.} \leq 125^{\circ}C$   
 soldering:  $T_{max.} \leq 135^{\circ}C$

Polypropylene: preheating:  $T_{max.} \leq 100^{\circ}C$   
 soldering:  $T_{max.} \leq 110^{\circ}C$

### Single wave soldering

Soldering bath temperature:  $T < 260^{\circ}C$   
 Dwell time:  $t < 5 \text{ sec}$

### Double wave soldering

Soldering bath temperature:  $T < 260^{\circ}C$   
 Dwell time:  $\Sigma t < 5 \text{ sec}$

Due to different soldering processes and heat requirements the graphs are to be regarded as a recommendation only.

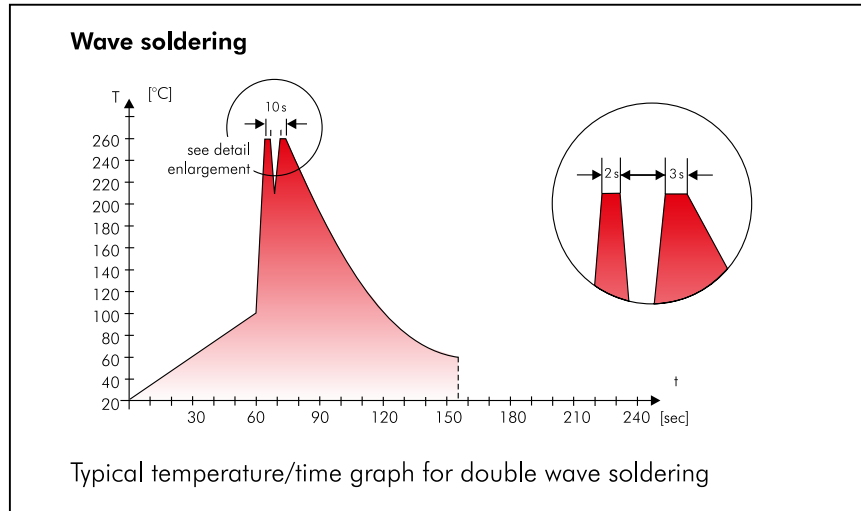

## WIMA Quality and Environmental Philosophy

### ISO 9001:2015 Certification

ISO 9001:2015 is an international basic standard of quality assurance systems for all branches of industry. The approval according to ISO 9001:2015 of our factories by the infaz (Institut für Auditierung und Zertifizierung) certifies that organisation, equipment and monitoring of quality assurance in our factories correspond to internationally recognized standards.

### WIMA WPCS

The WIMA Process Control System (WPCS) is a quality surveillance and optimization system developed by WIMA. WPCS is a major part of the quality-oriented WIMA production. Points of application during production process:

- incoming material inspection
- metallization
- film inspection
- schoopage
- pre-healing
- pin attachment
- cast resin preparation/encapsulation
- 100% final inspection
- Testing as per customer requirements

### WIMA Environmental Policy

All WIMA capacitors, irrespective of whether through-hole devices or SMD, are made of environmentally friendly materials. Neither during manufacture nor in the product itself any toxic substances are used, e.g.

- Lead
- PCB
- CFC
- Hydrocarbon chloride
- Chromium 6+
- PBB/PBDE
- Arsenic
- Cadmium
- Mercury
- etc.

We merely use pure, recyclable materials for packing our components, such as:

- carton
- cardboard
- adhesive tape made of paper
- polystyrene

We almost completely refrain from using packing materials such as:

- adhesive tapes made of plastic
- metal clips

### RoHS Compliance

According to the RoHS Directive 2011/65/EU as amended from time to time certain hazardous substances like e.g. lead, cadmium, mercury must not be used any longer in electronic equipment as of July 1st, 2006. For the sake of the environment WIMA has refrained from using such substances since years already.



WIMA Kondensatoren sind bleifrei konform RoHS 2011/65/EU

WIMA capacitors are lead free in accordance with RoHS 2011/65/EU

Tape for lead-free WIMA capacitors

### DIN EN ISO 14001:2004

WIMA's environmental management has been established in accordance with the guidelines of DIN EN ISO 14001:2004 to optimize the production processes with regard to energy and resources.

# Typical Dimensions for Taping Configuration

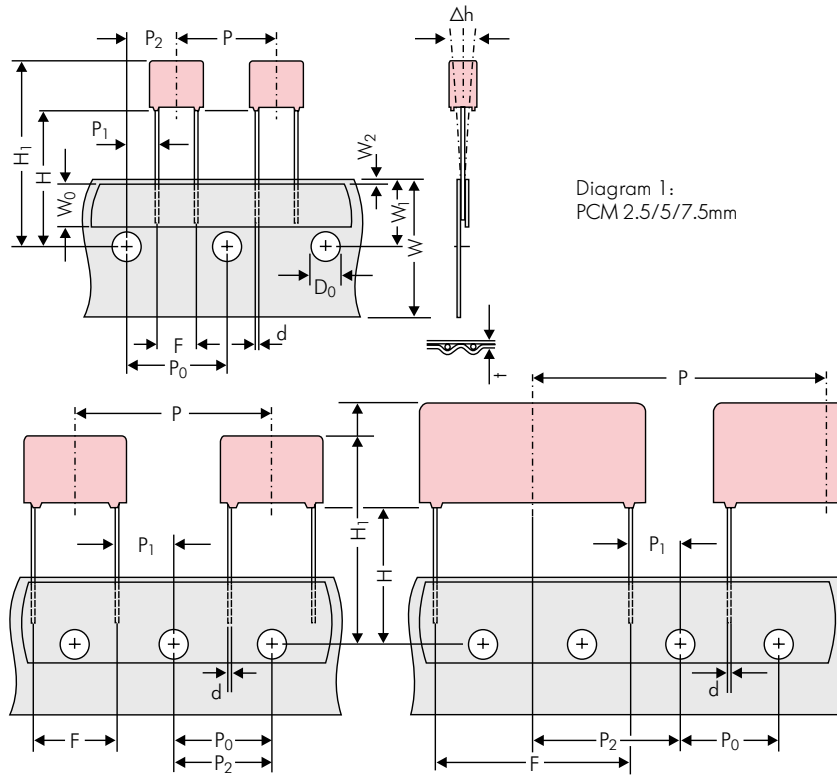

Diagram 1:  
PCM 2.5/5/7.5mm

Diagram 2: PCM 10/15 mm

Diagram 3: PCM 22.5 and 27.5\*mm

\*PCM 27.5 taping possible with two feed holes between components

Designation	Symbol	Dimensions for Radial Taping						
		PCM 2.5 taping	PCM 5 taping	PCM 7.5 taping	PCM 10 taping*	PCM 15 taping*	PCM 22.5 taping	PCM 27.5 taping
Carrier tape width	W	18.0 ±0.5	18.0 ±0.5	18.0 ±0.5	18.0 ±0.5	18.0 ±0.5	18.0 ±0.5	18.0 ±0.5
Hold-down tape width	W <sub>0</sub>	6.0 for hot-sealing adhesive tape	6.0 for hot-sealing adhesive tape	12.0 for hot-sealing adhesive tape	12.0 for hot-sealing adhesive tape	12.0 for hot-sealing adhesive tape	12.0 for hot-sealing adhesive tape	12.0 for hot-sealing adhesive tape
Hole position	W <sub>1</sub>	9.0 ±0.5	9.0 ±0.5	9.0 ±0.5	9.0 ±0.5	9.0 ±0.5	9.0 ±0.5	9.0 ±0.5
Hold-down tape position	W <sub>2</sub>	0.5 to 3.0 max.	0.5 to 3.0 max.	0.5 to 3.0 max.	0.5 to 3.0 max.	0.5 to 3.0 max.	0.5 to 3.0 max.	0.5 to 3.0 max.
Feed hole diameter	D <sub>0</sub>	4.0 ±0.2	4.0 ±0.2	4.0 ±0.2	4.0 ±0.2	4.0 ±0.2	4.0 ±0.2	4.0 ±0.2
Pitch of component	P	12.7 ±1.0	12.7 ±1.0	12.7 ±1.0	25.4 ±1.0	25.4 ±1.0	38.1 ±1.5	38.1 ±1.5 or 50.8 ±1.5
Feed hole pitch	P <sub>0</sub>	12.7 ±0.3 cumulative pitch error max. 1.0 mm/20 pitch	12.7 ±0.3 cumulative pitch error max. 1.0 mm/20 pitch	12.7 ±0.3 cumulative pitch error max. 1.0 mm/20 pitch	12.7 ±0.3 cumulative pitch error max. 1.0 mm/20 pitch	12.7 ±0.3 cumulative pitch error max. 1.0 mm/20 pitch	12.7 ±0.3 cumulative pitch error max. 1.0 mm/20 pitch	12.7 ±0.3 cumulative pitch error max. 1.0 mm/20 pitch
Feed hole centre to pin	P <sub>1</sub>	5.1 ±0.5	3.85 ±0.7	2.6 ±0.7	7.7 ±0.7	5.2 ±0.7	7.8 ±0.7	5.3 ±0.7
Hole centre to component centre	P <sub>2</sub>	6.35 ±1.3	6.35 ±1.3	6.35 ±1.3	12.7 ±1.3	12.7 ±1.3	19.05 ±1.3	19.05 ±1.3
Feed hole centre to bottom edge of the component	H	16.5 ±0.3 18.5 ±0.5	16.5 ±0.3 18.5 ±0.5	16.5 ±0.5 18.5 ±0.5	16.5 ±0.5 18.5 ±0.5	16.5 ±0.5 18.5 ±0.5	16.5 ±0.5 18.5 ±0.5	16.5 ±0.5 18.5 ±0.5
Feed hole centre to top edge of the component	H <sub>1</sub>	H+H <sub>component</sub> < H <sub>1</sub> 32.25 max.	H+H <sub>component</sub> < H <sub>1</sub> 32.25 max.	H+H <sub>component</sub> < H <sub>1</sub> 24.5 to 31.5	H+H <sub>component</sub> < H <sub>1</sub> 25.0 to 31.5	H+H <sub>component</sub> < H <sub>1</sub> 26.0 to 37.0	H+H <sub>component</sub> < H <sub>1</sub> 30.0 to 43.0	H+H <sub>component</sub> < H <sub>1</sub> 35.0 to 45.0
Pin spacing at upper edge of carrier tape	F	2.5 ±0.5	5.0 <sup>+0.8</sup> <sub>-0.2</sub>	7.5 ±0.8	10.0 ±0.8	15 ±0.8	22.5 ±0.8	27.5 ±0.8
Pin diameter	d	0.4 ±0.05	0.5 ±0.05	0.5 ±0.05 or 0.6 <sup>+0.06</sup> <sub>-0.05</sub>	0.5 ±0.05 or 0.6 <sup>+0.06</sup> <sub>-0.05</sub>	0.8 <sup>+0.08</sup> <sub>-0.05</sub>	0.8 <sup>+0.08</sup> <sub>-0.05</sub>	0.8 <sup>+0.08</sup> <sub>-0.05</sub>
Component alignment	Δh	± 2.0 max.	± 2.0 max.	± 3.0 max.	± 3.0 max.	± 3.0 max.	± 3.0 max.	± 3.0 max.
Total tape thickness	t	0.6 ±0.2	0.6 ±0.2	0.6 ±0.2	0.6 ±0.2	0.6 ±0.2	0.6 ±0.2	0.6 ±0.2
Package (see also page 162)	ROLL/AMMO			AMMO				
	REEL	φ 360 max. φ 30 ±1	B 52 ±2 58 ±2 } depending on comp. dimensions	REEL	φ 360 max. φ 30 ±1	52 ±2 58 ±2 or 66 ±2	REEL	φ 500 max. φ 25 ±1
Unit	see details page 163.							

Dims in mm.

\* Diameter of pins see General Data.

\* PCM 10 and PCM 15 can be crimped to PCM 7.5.

Position of components according to PCM 7.5 (sketch 11). P<sub>0</sub> = 12.7 or 15.0 is possible

Please clarify customer-specific deviations with the manufacturer.

## Types of Tape Packaging of Capacitors for Automatic Radial Insertion

### ■ ROLL Packaging

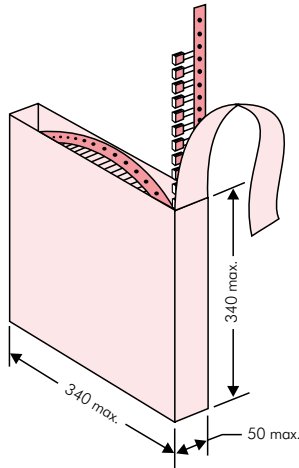

### ■ AMMO Packaging

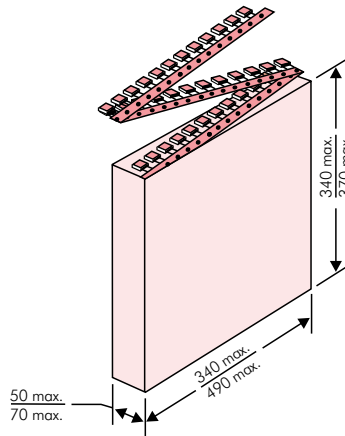

### ■ REEL Packaging

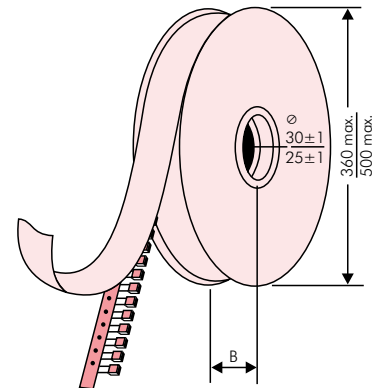

## BAR CODE (Labelling)

Labelling of package units in plain text and with alphanumerical Bar Code

- WIMA supplier number
- Date code
- Customer's P/O number
- P/O line
- Customer's part number
- WIMA part number
- Quantity
- WIMA confirmation number
- Country of origin
- Customer name
- Handling unit number
- Week of delivery.

In addition part description of

- article
- capacitance value
- rated voltage
- dimensions
- technical note
- capacitance tolerance
- packing
- connecting information

<b>WIMA</b> Best Capacitors Made in Germany	
Werk Aurich	
Supplier - ID: LIEF.NR.	Date Code: 20210419
Purchase Order No. (P/O): Bestellung xyz	P/O line: 100
Customer Part No.: KUNDENTEILENUMMER	
WIMA Part No.: MKP1F041006B00KSSD	Quantity: 459
WIMA Confirmation No.: 0001105072000100	
Customer No.: 0000100002	RoHS 2011/65/EU
Gross Weight [g]: 4557	COO: DE
WIMA - MKP 10      WIMA Part No.: MKP1F041006B00KSSD	
MKP 10 1.0 µF 250 VDC 11x21x31.5 RM27.5	
Standard 10%    Lose - Standard    Drähte 6-2	
Vorlage Debitor Inland	
	0001105072000100
1002021443	QTY: 459    Week 19/2021

BARCODE PDF417  
BARCODE 2D Datamatrix



# Packing Quantities for Capacitors with Radial Pins in PCM 2.5 mm to 22.5 mm



PCM	Size				bulk	pcs. per packing unit								
						ROLL		REEL				AMMO		
	W	H	L	Codes		S	H16.5	H18.5	ø 360	ø 500	340 x 340	490 x 370		
					N	O	F	I	H	J	A	C	B	D
<b>2.5 mm</b>	2.5	7	4.6	<b>0B</b>	5000		2200	2500				2800		
	3	7.5	4.6	<b>0C</b>	5000		2000	2300				2300		
	3.8	8.5	4.6	<b>0D</b>	5000		1500	1800				1800		
	4.6	9	4.6	<b>0E</b>	5000		1200	1500				1500		
	5.5	10	4.6	<b>0F</b>	5000		900	1200				1200		
<b>5 mm</b>	2.5	6.5	7.2	<b>1A</b>	5000		2200	2500				2800		
	3	7.5	7.2	<b>1B</b>	5000		2000	2300				2300		
	3.5	8.5	7.2	<b>1C</b>	5000		1600	2000				2000		
	4.5	6	7.2	<b>1D</b>	6000		1300	1500				1500		
	4.5	9.5	7.2	<b>1E</b>	4000		1300	1500				1500		
	5	10	7.2	<b>1F</b>	3500		1100	1400				1400		
	5.5	7	7.2	<b>1G</b>	4000		1000	1200				1200		
	5.5	11.5	7.2	<b>1H</b>	2500		1000	1200				1200		
	6.5	8	7.2	<b>1I</b>	2500		800	1000				1000		
	7.2	8.5	7.2	<b>1J</b>	2500		700	1000				1000		
	7.2	13	7.2	<b>1K</b>	2000		700	950				1000		
8.5	10	7.2	<b>1L</b>	2000		600	800				800			
8.5	14	7.2	<b>1M</b>	1500		600	800				800			
11	16	7.2	<b>1N</b>	1000		500	600				640			
<b>7.5 mm</b>	2.5	7	10	<b>2A</b>	5000			2500	4400			2500		
	3	8.5	10	<b>2B</b>	5000			2200	4300			2300	4150	
	4	9	10	<b>2C</b>	4000			1700	3200			1700	3000	
	4.5	9.5	10.3	<b>2D</b>	3500			1500	2900			1400	2700	
	5	10.5	10.3	<b>2E</b>	3000			1300	2500			1300		
	5.7	12.5	10.3	<b>2F</b>	2000			1000	2200			1100		
	7.2	12.5	10.3	<b>2G</b>	1500			900	1800			1000		
<b>10 mm</b>	3	9	13	<b>3A</b>	3000			1100	2200				1900	
	4	8.5	13.5	<b>FA</b>	3000			900	1600				1450	
	4	9	13	<b>3C</b>	3000			900	1600				1450	
	4	9.5	13	<b>3D</b>	3000			900	1600				1400	
	5	10	13.5	<b>FB</b>	2000			700	1300				1200	
	5	11	13	<b>3F</b>	3000			700	1300				1100	
	6	12	13	<b>3G</b>	2400			550	1100				1000	
	6	12.5	13	<b>3H</b>	2400			550	1100				1000	
8	12	13	<b>3I</b>	2000			400	800				740		
<b>15 mm</b>	5	11	18	<b>4B</b>	2400			600	1200				1150	
	5	13	19	<b>FC</b>	1000			600	1200				1200	
	6	12.5	18	<b>4C</b>	2000			500	1000				1000	
	6	14	19	<b>FD</b>	1000			500	1000				1000	
	7	14	18	<b>4D</b>	1600			450	900				850	
	7	15	19	<b>FE</b>	1000			450	900				850	
	8	15	18	<b>4F</b>	1200			400	800				740	
	8	17	19	<b>FF</b>	500			400	800				740	
	9	14	18	<b>4H</b>	1200			350	700				650	
	9	16	18	<b>4J</b>	900			350	700				650	
<b>22.5 mm</b>	5	14	26.5	<b>5A</b>	1200				800				770	
	6	15	26.5	<b>5B</b>	1000				700				640	
	7	16.5	26.5	<b>5D</b>	760				600				550	
	8	20	28	<b>FH</b>	500				500				480	
	8.5	18.5	26.5	<b>5F</b>	500				480				450	
	10	22	28	<b>FI</b>	570*				420				380	
	10.5	19	26.5	<b>5G</b>	594*				400				360	
	10.5	20.5	26.5	<b>5H</b>	594*				400				360	
11	21	26.5	<b>5I</b>	561*				380				350		
12	24	28	<b>FJ</b>	480*				350				310		

\* TPS (Tray-Packing-System). Plate versions may have different packing units. Samples and pre-production needs on request.

■ Moulded versions.

Rights reserved to amend design data without prior notification.



## Packing Quantities for Capacitors with Radial Pins in PCM 27.5 mm to 52.5 mm

PCM	Size				bulk	pcs. per packing unit											
						ROLL		REEL				AMMO					
	W	H	L	Codes		S	N	O	ø 360		ø 500		340 x 340		490 x 370		
								H16.5	H18.5	H16.5	H18.5	H16.5	H18.5	H16.5	H18.5	H16.5	H18.5
								F	I	H	J	A	C	B	D		
<b>27.5 mm</b>	9	19	31.5	<b>6A</b>	567*	-	-	-	-	460/340*	-	-	-	-	-	-	-
	11	21	31.5	<b>6B</b>	459*	-	-	-	-	380/280*	-	-	-	-	-	-	-
	13	24	31.5	<b>6D</b>	378*	-	-	-	-	300	-	-	-	-	-	-	-
	13	25	33	<b>FK</b>	405*	-	-	-	-	-	-	-	-	-	-	-	-
	15	26	31.5	<b>6F</b>	324*	-	-	-	-	270	-	-	-	-	-	-	-
	15	26	33	<b>FL</b>	324*	-	-	-	-	-	-	-	-	-	-	-	-
	17	29	31.5	<b>6G</b>	198*	-	-	-	-	-	-	-	-	-	-	-	-
	17	34.5	31.5	<b>6I</b>	198*	-	-	-	-	-	-	-	-	-	-	-	-
	20	32	33	<b>FM</b>	162*	-	-	-	-	-	-	-	-	-	-	-	-
20	39.5	31.5	<b>6J</b>	162*	-	-	-	-	-	-	-	-	-	-	-	-	
<b>37.5 mm</b>	9	19	41.5	<b>7A</b>	441*	-	-	-	-	-	-	-	-	-	-	-	
	11	22	41.5	<b>7B</b>	357*	-	-	-	-	-	-	-	-	-	-	-	
	13	24	41.5	<b>7C</b>	294*	-	-	-	-	-	-	-	-	-	-	-	
	15	26	41.5	<b>7D</b>	252*	-	-	-	-	-	-	-	-	-	-	-	
	17	29	41.5	<b>7E</b>	154*	-	-	-	-	-	-	-	-	-	-	-	
	19	32	41.5	<b>7F</b>	140*	-	-	-	-	-	-	-	-	-	-	-	
	20	39.5	41.5	<b>7G</b>	126*	-	-	-	-	-	-	-	-	-	-	-	
	24	45.5	41.5	<b>7H</b>	112*	-	-	-	-	-	-	-	-	-	-	-	
	28	38	41.5	<b>7L</b>	84*	-	-	-	-	-	-	-	-	-	-	-	
	31	46	41.5	<b>7I</b>	84*	-	-	-	-	-	-	-	-	-	-	-	
	35	50	41.5	<b>7J</b>	35*	-	-	-	-	-	-	-	-	-	-	-	
40	55	41.5	<b>7K</b>	28*	-	-	-	-	-	-	-	-	-	-	-		
<b>48.5 mm</b>	19	31	56	<b>8D</b>	120*	-	-	-	-	-	-	-	-	-	-		
	23	34	56	<b>8E</b>	80*	-	-	-	-	-	-	-	-	-	-		
	27	37.5	56	<b>8H</b>	84*	-	-	-	-	-	-	-	-	-	-		
	33	48	56	<b>8J</b>	25*	-	-	-	-	-	-	-	-	-	-		
	37	54	56	<b>8L</b>	25*	-	-	-	-	-	-	-	-	-	-		
<b>52.5 mm</b>	25	45	57	<b>9D</b>	70*	-	-	-	-	-	-	-	-	-	-		
	30	45	57	<b>9E</b>	60*	-	-	-	-	-	-	-	-	-	-		
	35	50	57	<b>9F</b>	25*	-	-	-	-	-	-	-	-	-	-		
	45	55	57	<b>9H</b>	20*	-	-	-	-	-	-	-	-	-	-		
	45	65	57	<b>9J</b>	20*	-	-	-	-	-	-	-	-	-	-		

\* for 2-inch transport pitches.

\* TPS (Tray-Packing-System). Plate versions may have different packing units. Samples and pre-production needs on request.

■ Moulded versions. Rights reserved to amend design data without prior notification.

Updated data on [www.wima.com](http://www.wima.com)



A WIMA part number consists of 18 digits and is composed as follows:

- Field 1 - 4: Type description
- Field 5 - 6: Rated voltage
- Field 7 - 10: Capacitance
- Field 11 - 12: Size and PCM
- Field 13 - 14: Version code (e.g. Snubber versions)
- Field 15: Capacitance tolerance
- Field 16: Packing
- Field 17 - 18: Pin length (untaped)

1	2	3	4	5	6	7	8	9	10	11	12	13	14	15	16	17	18
<b>M</b>	<b>K</b>	<b>S</b>	<b>2</b>	<b>C</b>	<b>0</b>	<b>2</b>	<b>1</b>	<b>0</b>	<b>0</b>	<b>1</b>	<b>A</b>	<b>0</b>	<b>0</b>	<b>M</b>	<b>S</b>	<b>S</b>	<b>D</b>
MKS 2				63 VDC		0.01 µF			2.5x6.5x7.2		-		20%	bulk	6 -2		

<p><b>Type description:</b></p> <p>SMD-PET = SMDT              SMD-PEN = SMDN              SMD-PPS = SMDI              FKP 02 = FKPO              MKS 02 = MKS0              FKS 2 = FKS2              FKP 2 = FKP2              FKS 3 = FKS3              FKP 3 = FKP 3              MKS 2 = MKS2              MKP 2 = MKP2              MKS 4 = MKS4              MKP 4 = MKP4              MKP 10 = MKP1              FKP 4 = FKP4              FKP 1 = FKP1              MKP-X2 = MKX2              MKP-X1 R = MKX1              MKP-Y2 = MKY2              MP 3-X2 = MPX2              MP 3-X1 = MPX1              MP 3-Y2 = MPY2              MP 3R-Y2 = MPRY              MKP 4F = MKPF              Snubber MKP = SNMP              Snubber FKP = SNFP              GTO MKP = GTOM              DC-LINK MKP 4 = DCP4              DC-LINK MKP 6 = DCP6              DC-LINK HC = DCHC</p>	<p><b>Rated voltage:</b></p> <p>50 VDC = B0              63 VDC = C0              100 VDC = D0              250 VDC = F0              400 VDC = G0              450 VDC = H0              520 VDC = H2              600 VDC = I0              630 VDC = J0              700 VDC = K0              800 VDC = L0              850 VDC = M0              900 VDC = N0              1000 VDC = O1              1100 VDC = P0              1200 VDC = Q0              1250 VDC = R0              1500 VDC = S0              1600 VDC = T0              1700 VDC = TA              2000 VDC = U0              2500 VDC = V0              3000 VDC = W0              4000 VDC = X0              6000 VDC = Y0              250 VAC = 0W              275 VAC = 1W              300 VAC = 2W              305 VAC = AW              350 VAC = BW              440 VAC = 4W              500 VAC = 5W              ...</p>	<p><b>Capacitance:</b></p> <p>22 pF = 0022              47 pF = 0047              100 pF = 0100              150 pF = 0150              220 pF = 0220              330 pF = 0330              470 pF = 0470              680 pF = 0680              1000 pF = 1100              1500 pF = 1150              2200 pF = 1220              3300 pF = 1330              4700 pF = 1470              6800 pF = 1680              0.01 µF = 2100              0.022 µF = 2220              0.047 µF = 2470              0.1 µF = 3100              0.22 µF = 3220              0.47 µF = 3470              1 µF = 4100              2.2 µF = 4220              4.7 µF = 4470              10 µF = 5100              22 µF = 5220              47 µF = 5470              100 µF = 6100              220 µF = 6220              1000 µF = 7100              1500 µF = 7150              ...</p>	<p><b>Size:</b></p> <p>4.8x3.3x3 Size 1812 = KA              4.8x3.3x4 Size 1812 = KB              5.7x5.1x3.5 Size 2220 = QA              5.7x5.1x4.5 Size 2220 = QB              7.2x6.1x3 Size 2824 = TA              7.2x6.1x5 Size 2824 = TB              10.2x7.6x5 Size 4030 = VA              12.7x10.2x6 Size 5040 = XA              15.3x13.7x7 Size 6054 = YA              2.5x7x4.6 PCM 2.5 = 0B              3x7.5x4.6 PCM 2.5 = 0C              2.5x6.5x7.2 PCM 5 = 1A              3x7.5x7.2 PCM 5 = 1B              2.5x7x10 PCM 7.5 = 2A              3x8.5x10 PCM 7.5 = 2B              3x9x13 PCM 10 = 3A              4x9x13 PCM 10 = 3C              5x11x18 PCM 15 = 4B              6x12.5x18 PCM 15 = 4C              5x14x26.5 PCM 22.5 = 5A              6x15x26.5 PCM 22.5 = 5B              9x19x31.5 PCM 27.5 = 6A              11x21x31.5 PCM 27.5 = 6B              9x19x41.5 PCM 37.5 = 7A              11x22x41.5 PCM 37.5 = 7B              19x31x56 PCM 48.5 = 8D              25x45x57 PCM 52.5 = 9D              ...</p>	<p><b>Tolerance:</b></p> <p>±20% = M              ±10% = K              ±5% = J              ±2.5% = H              ±1% = E              ...</p> <p><b>Packing:</b></p> <p>AMMO H16.5 340x340 = A              AMMO H16.5 490x370 = B              AMMO H18.5 340x340 = C              AMMO H18.5 490x370 = D              REEL H16.5 360 = F              REEL H16.5 500 = H              REEL H18.5 360 = I              REEL H18.5 500 = J              ROLL H16.5 = N              ROLL H18.5 = O              BLISTER W12 180 = P              BLISTER W12 330 = Q              BLISTER W16 330 = R              BLISTER W24 330 = T              Bulk/TPS Standard = S              ...</p>
			<p><b>Version code:</b></p> <p>Standard = 00              Version A1 = 1A              Version A1.1.1 = 1B              Version A2 = 2A              ...</p>	<p><b>Pin length (untaped)</b></p> <p>3.5 ±0.5 = C9              6 -2 = SD              16 ±1 = P1              ...</p> <p><b>Pin length (taped)</b></p> <p>none = 00</p>

The data on this page is not complete and serves only to explain the part number system. Part number information is listed on the pages of the respective WIMA range.