

Customer Part:

Description

- 0.9V low voltage oscillator in a hermetically sealed 2.5 x 2.0mm surface mount ceramic package.
- Model IQXO-691 2520-09
- Model Issue number 2

Frequency Parameters

- Frequency 40.0MHz
- Frequency Stability $\pm 50.00\text{ppm}$
- Operating Temperature Range -40.00 to 85.00°C
- Ageing $\pm 3\text{ppm}$ max in 1st year @ 25°C

Electrical Parameters

- Supply Voltage $0.9\text{V} \pm 5\%$
- Current Draw 10.000mA

Output Details

- Output Compatibility CMOS
- Drive Capability 15pF max
- Rise and Fall Time 7.0ns max
- Duty Cycle 45/55%
- Output Voltage Levels:
Output Low (VoL): $10\%V_s$ max
Output High (VoH): $90\%V_s$ min
- Start Up Time: 10ms max

Output Control

- Standby Operation:
Logic '1' ($\geq 70\% V_s$) to pad 1 enables oscillator output.
Logic '0' ($\leq 30\% V_s$) to pad 1 disables oscillator output; when disabled the oscillator output goes to the high impedance state.
No connection to pad 1 enables oscillator output (internal pull-up resistor).
- Standby Current: $100\mu\text{A}$ max

Noise Parameters

- RMS Phase Jitter (12kHz to 20MHz): 1ps max

Environmental Parameters

- Storage Temperature Range: -55 to 125°C
- Mechanical Shock: MIL-STD-883, Method 2002, Condition B.
- Vibration: MIL-STD-883, Method 2007, Condition A.
- Moisture Resistance: MIL-STD-883, Method 1004.
- Thermal Cycling: MIL-STD-883, Method 1010, Condition B.
- Solderability: MIL-STD-883, Method 2003.
- Resistance to Soldering Heat: MIL-STD-202, Method 210, Condition K.
- Fine Leak Test: MIL-STD-883, Method 1014, Condition A.
- Gross Leak Test: MIL-STD-883, Method 1014, Condition C.

Manufacturing Details

- Note: Please connect a bypass capacitor of $0.1\mu\text{F}$ between +Vs and circuit ground.
- RoHS Terminations Au
- RoHS Reflow Temp 260°C max for 10secs max

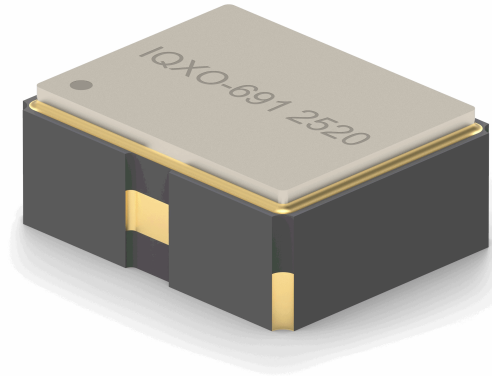
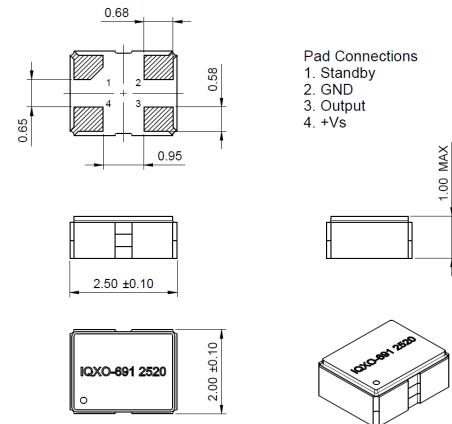
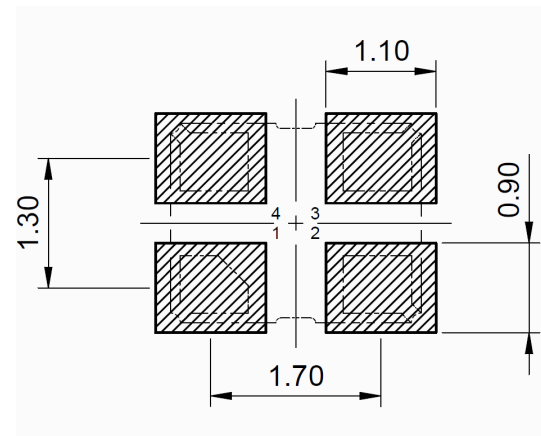
Outline (mm)

Recommended Solder Pad Layout

Sales Office Contact Details:

UK: +44 (0)1460 270200
Germany: 0800 1808 443

France: 0800 901 383
USA: +1.760.318.2824

Email: info@iqdfrequencyproducts.com
Web: www.iqdfrequencyproducts.com



Customer Part:

Compliance

- RoHS Status (2015/863/EU) Compliant
- REACH Status Compliant
- MSL Rating (JDEC-STD-033): 1

Packaging Details

- Pack Style: Reel Tape & reel in accordance with EIA-481D
Pack Size: 3,000
- *Alternative packing option available*

Sales Office Contact Details:

UK: +44 (0)1460 270200
Germany: 0800 1808 443

France: 0800 901 383
USA: +1.760.318.2824

Email: info@iqdfrequencyproducts.com
Web: www.iqdfrequencyproducts.com