

■ Features

- Kyocera's series of Multilayer Ceramic Chip Capacitors are designed to meet a wide variety of needs. We offer a complete range of products for both general and specialized applications.
- We have a network worldwide in order to supply our global customer bases quickly and efficiently.
- All our products are highly reliable due to their monolithic structure of high-purity and superfine uniform ceramics and their integral internal electrodes.
- Our stringent quality control in every phase of production from material procurement to shipping ensures consistent manufacturing and superior quality.
- Kyocera components are available in a wide choice of dimensions, temperature characteristics, rated voltages, and terminations to meet specific configurational requirements.

■ KYOCERA PART NUMBER

CM 03 X5R 225 M 06 A H □□□
 ① ② ③ ④ ⑤ ⑥ ⑦ ⑧ OPTION :

Above digits are used to track individual specification or thickness.

(Example)

- ① Series : CM Series(General)
- ② Size : 0201
- ③ Dielectric : X5R
- ④ Capacitance : 2.2 μ F
- ⑤ Tolerance : \pm 20%
- ⑥ Voltage : 6.3Vdc
- ⑦ Termination : Sn
- ⑧ Packaging : Cavity pitch 2mm / Reel Size ϕ 180

① SERIES CODE

CODE	Type
CM	General
CT	Low Profile
CU	High-Q
KNH	Three Terminal Capacitors

② SIZE CODE

CODE	EIA	JIS
02	01005	0402
03	0201	0603
05	0402	1005
105	0603	1608
21	0805	2012
316	1206	3216
32	1210	3225

③ DIELECTRIC CODE

Temperature Compensation Type			
CODE	Temperature Range (°C)	ppm/°C	
CG	-55 to 125	0	\pm 30
CH			\pm 60

- All parts of COG will be marked as "CG" but will conform to the above table.
- Temperature coefficients are determined by calculation based on measurement at 20°C and 85°C.

High Dielectric Constant Type			
CODE	Temperature Range (°C)	Δ C max. (%)	Standard Temperature (°C)
X5R	-55 to 85	\pm 15	25
X6S	-55 to 105	\pm 22	
X6T		+22/-33	
X7R		\pm 15	
X7S	-55 to 125	\pm 22	
X7T		+22/-33	

④ CAPACITANCE CODE

Capacitance expressed in pF.
Two significant digits plus number of zeros.
For Values < 10pF, Letter R denotes decimal point,
<1,000pF=1nF, 1,000nF=1 μ F>

(Example)

CODE	Capacitance
R50	0.5pF
1R0	1pF
100	10pF
101	100pF
102	1nF
103	10nF
104	100nF
105	1 μ F
106	10 μ F
107	100 μ F

E STANDARD NUMBER					
CODE	E3	E6	E12	E24	
1.0	1.0	1.0	1.0	1.1	
		1.2	1.2	1.3	
	1.5	1.5	1.5	1.6	
		1.8	1.8	2.0	
2.2	2.2	2.2	2.2	2.4	
		2.7	2.7	3.0	
	3.3	3.3	3.3	3.6	
		3.9	3.9	4.3	
4.7	4.7	4.7	4.7	5.1	
		5.6	5.6	6.2	
	6.8	6.8	6.8	7.5	
		8.2	8.2	9.1	

⑤ TOLERANCE CODE

Temperature Compensation Type (COG)	
CODE	Tolerance
A*	\pm 0.05pF
B	\pm 0.1pF
C	\pm 0.25pF
D	\pm 0.5pF
G*	\pm 2%
J	\pm 5%
K	\pm 10%

* : Option

⑥ VOLTAGE CODE

CODE	Rated Vltage
02	2.5Vdc
04	4Vdc
06	6.3Vdc
10	10Vdc
16	16Vdc
25	25Vdc
35	35Vdc
50	50Vdc
100	100Vdc

⑦ TERMINATION CODE

CODE	Termination
A	Nickel Barrier/ Tin

* Please contact us if Au termination is needed.

⑧ PACKAGING CODE

CODE	Size Code	Cavity pitch	Reel size
T	105 to 32	4mm	ϕ 180
H	02 to 05	2mm	
Q	03/05	1mm	
P	02	1mm	
L	105 to 32	4mm	ϕ 330
N	02 to 05	2mm	
W	03/05	1mm	

High Dielectric Constant Type (X5R/X6S/X6T/X7R/X7S/X7T)	
CODE	Tolerance
J*	\pm 5%
K	\pm 10%
M	\pm 20%

* : Option



Dimension

■CM/CT/CU Series

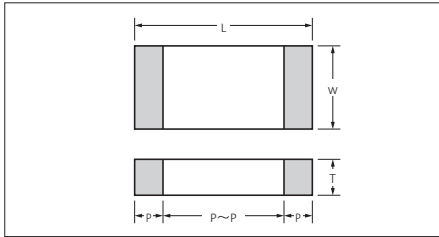

■Packaging Code

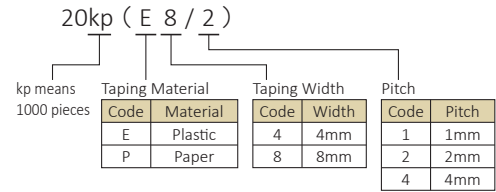

Size	Code		Dimension Code	Dimension (mm)						Quantity per reel	
	EIA	JIS		L	W	T	P min.	P max.	P to P min.	φ180 Reel	φ330 Reel
02	01005	0402	A	0.4±0.02	0.2±0.02	0.2±0.02	0.07	0.14	0.13	40kp(E4/1) 20kp(P8/2)	— 80kp(P8/2)
03	0201	0603	A	0.6±0.03	0.3±0.03	0.22 max.	0.10	0.20	0.20	30kp(P8/1) 15kp(P8/2)	150kp(P8/1) 50kp(P8/2)
			B			0.3±0.03					
			C	0.6±0.05	0.3±0.05	0.3±0.05	0.13	0.23	0.19	15kp(P8/2)	50kp(P8/2)
			D			0.22 max.					
			E			0.3±0.09					
F	0.5±0.05										
05	0402	1005	A	1.0±0.05	0.5±0.05	0.22 max.	0.15	0.35	0.30	20kp(P8/1) 10kp(P8/2)	100kp(P8/1) 50kp(P8/2)
			B			0.33 max.					
			C			0.5±0.05					
			D	1.0±0.10	0.5±0.05	0.22 max.	0.15	0.35	0.30	10kp(P8/2)	50kp(P8/2)
			E			0.5±0.15					
			F	1.0±0.15	0.5±0.15	0.33 max.	0.15	0.35	0.30	10kp(P8/2)	—
			G			0.50 max.					
			H			0.55 max.					
			J			0.5±0.20					
			K			0.80 max.					
			105	0603	1608	A	1.6±0.10	0.8±0.10	0.55 max.	0.20	0.60
B	0.8±0.10										
C	1.6±0.15	0.8±0.15				0.8±0.15	0.20	0.60	0.50	4kp(P8/4)	10kp(P8/4)
D						0.8±0.20					
21	0805	2012	B	2.0±0.10	1.25±0.10	1.25±0.10	0.20	0.75	0.70	3kp(E8/4) 4kp(P8/4)	10kp(E8/4) 10kp(P8/4)
			C			0.95 max.					
			E	2.0±0.20	1.25±0.20	0.95 max.	0.20	0.75	0.70	4kp(P8/4)	10kp(P8/4)
			F			1.25±0.20					
						—					
316	1206	3216	A	3.2±0.20	1.6±0.15	1.6±0.15	0.30	0.85	1.40	2.5kp(E8/4)	5kp(E8/4)
			B			1.6±0.20					
			C	3.2±0.30	1.6±0.30	1.6±0.30	0.30	0.85	1.90	2kp(E8/4)	—
	—										
32	1210	3225	A	3.2±0.30	2.5±0.20	2.5±0.20	0.30	1.00	1.40	1kp(E8/4)	4kp(E8/4)

■KNH Series

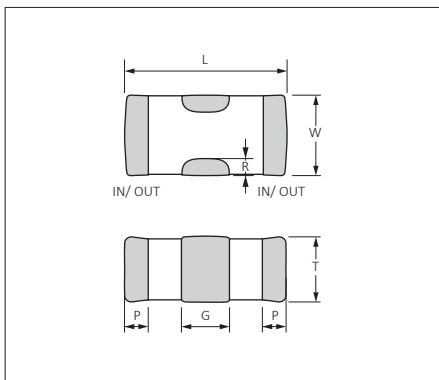

Size	Code		Dimension Code	Dimension (mm)						Packaging	
	EIA	JIS		L	W	T	G	P	R	φ180 Reel	φ330 Reel
KNH 05	0402	1005	A	1.0±0.10	0.5±0.20	0.5 max.	0.3±0.10	0.15±0.10	≥0.05	10kp(P8/2)	—
			B	1.0±0.15	0.5±0.15	0.5±0.15					
			C	1.0±0.20	0.5±0.20	0.5±0.20					



■ Features

We offer a diverse product line ranging from ultra-compact (0.4×0.2mm) to large (3.2×2.5mm) components configured for a variety of temperature characteristics, rated voltages, and packages. We offer the choice and flexibility for almost any applications.

■ Applications

This standard type is ideal for use in a wide range of applications, from commercial to industrial equipment.

Temperature Compensation Dielectric

● Capacitance chart ■ Standard Spec.1

Size (EIA Code)	Rated Voltage(Vd.c) Capacitance	CM02 (01005)		CM03 (0201)
		16	25	50
1R0	1.0 pF			
1R5	1.5 pF			
2R0	2.0 pF			
3R0	3.0 pF			
4R0	4.0 pF			
5R0	5.0 pF			
6R0	6.0 pF			
7R0	7.0 pF			
8R0	8.0 pF			
9R0	9.0 pF			
100	10 pF			
120	12 pF			
150	15 pF			
180	18 pF			
220	22 pF			
270	27 pF			
330	33 pF			
390	39 pF			
470	47 pF			
560	56 pF			
680	68 pF			
820	82 pF			
101	100 pF			
121	120 pF			
151	150 pF			
181	180 pF			
221	220 pF			

<Standard Capacitor Value: E12 Series>

Please contact for capacitance value other than standard.

Please refer [here](#) for the test method and specifications of Standard Specification 1.

Alphabets in capacitance chart denote dimensions. Please refer to the below table for detail.

(Example) In case of "B" for CM03;

L: 0.6±0.03mm, W: 0.3±0.03mm, T: 0.3±0.03mm

Size	Dimension Code	Dimension (mm)			Packaging									
					φ180 Reel					φ330 Reel				
		L	W	T	Code	Quantity	Taping Material	Taping Width	Cavity Pitch	Code	Quantity	Taping Material	Taping Width	Cavity Pitch
02	A	0.4±0.02	0.2±0.02	0.2±0.02	P	40,000	Plastic	4mm	1mm	—	—	—	—	—
					H	20,000	Paper	8mm	2mm	N	80,000	Paper	8mm	2mm
03	B	0.6±0.03	0.3±0.03	0.3±0.03	Q	30,000	Paper	8mm	1mm	W	150,000	Paper	8mm	1mm
					H	15,000	Paper	8mm	2mm	N	50,000	Paper	8mm	2mm



X5R Dielectric

● Capacitance chart ■ Standard Spec.1 ■ Standard Spec.2 ▨ Optional Spec.

Size (EIA Code)	CM02 (01005)			CM03 (0201)					CM05 (0402)					CM105 (0603)				
	6.3	10	16	4	6.3	10	16	25	4	6.3	10	16	25	35	10	16	25	35
Rated Voltage (Vdc)																		
Capacitance																		
101 100 pF																		
151 150 pF																		
221 220 pF																		
331 330 pF																		
471 470 pF																		
681 680 pF																		
102 1000 pF																		
152 1500 pF																		
222 2200 pF																		
332 3300 pF																		
472 4700 pF																		
682 6800 pF																		
103 10000 pF																		
153 15000 pF																		
223 22000 pF																		
333 33000 pF																		
473 47000 pF																		
683 68000 pF																		
104 0.10 μF																		
224 0.22 μF																		
474 0.47 μF																		
105 1.0 μF																		
225 2.2 μF																		
475 4.7 μF																		
106 10 μF																		
156 15 μF																		
226 22 μF																		

Size (EIA Code)	CM21 (0805)					CM316 (1206)				CM32 (1210)		
	4	6.3	10	16	25	16	25	50	100	16	25	50
Rated Voltage (Vdc)												
Capacitance												
105 1.0 μF												
225 2.2 μF												
475 4.7 μF												
106 10 μF												
226 22 μF												
476 47 μF												
107 100 μF												

<Standard Capacitance Value>

Capacitance value of less than 0.1μF :E6 Series

Capacitance value of 0.1μF and larger :E3 Series

Please contact for capacitance value other than standard.

Please refer [here](#) for the test method and specifications of Standard Specification 1.

Please refer [here](#) for the test method and specifications of Standard Specification 2.

Two digits alphanumerics in capacitance chart denote dimensions and tan δ. Please refer to the above table for detail.

(Example) In case of "B3" for CM03;

L: 0.6±0.03mm, W: 0.3±0.03mm, T: 0.3±0.03mm, Tanδ: 5.0% max.

Tan δ Code	Tan δ
3	5.0% max.
7	10.0% max.
8	12.5% max.
9	15.0% max.
10	20.0% max.

Size	Dimension Code	Dimension (mm)			Packaging									
		L	W	T	φ180 Reel					φ330 Reel				
					Code	Quantity	Taping Material	Taping Width	Cavity Pitch	Code	Quantity	Taping Material	Taping Width	Cavity Pitch
02	A	0.4±0.02	0.2±0.02	0.2±0.02	P	40,000	Plastic	4mm	1mm	—	—	—	—	—
					H	20,000	Paper	8mm	2mm	N	80,000	Paper	8mm	2mm
03	B	0.6±0.03	0.3±0.03	0.3±0.03	Q	30,000	Paper	8mm	1mm	W	150,000	Paper	8mm	1mm
					H	15,000	Paper	8mm	2mm	N	50,000	Paper	8mm	2mm
	C	0.6±0.05	0.3±0.05	0.3±0.05	Q	30,000	Paper	8mm	1mm	W	150,000	Paper	8mm	1mm
					H	15,000	Paper	8mm	2mm	N	50,000	Paper	8mm	2mm
	E	0.6±0.09	0.3±0.09	0.3±0.09	H	15,000	Paper	8mm	2mm	N	50,000	Paper	8mm	2mm
					H	10,000	Paper	8mm	2mm	—	—	—	—	—
05	C	1.0±0.05	0.5±0.05	0.5±0.05	Q	20,000	Paper	8mm	1mm	W	100,000	Paper	8mm	1mm
					H	10,000	Paper	8mm	2mm	N	50,000	Paper	8mm	2mm
	E	1.0±0.15	0.5±0.15	0.5±0.15	H	10,000	Paper	8mm	2mm	N	40,000	Paper	8mm	2mm
					H	10,000	Paper	8mm	2mm	—	—	—	—	—
	J	1.0±0.20	0.5±0.20	0.5±0.20	H	10,000	Paper	8mm	2mm	N	40,000	Paper	8mm	2mm
					H	10,000	Paper	8mm	2mm	N	30,000	Paper	8mm	2mm
105	B	1.6±0.10	0.8±0.10	0.8±0.10	T	4,000	Paper	8mm	4mm	L	10,000	Paper	8mm	4mm
					T	4,000	Paper	8mm	4mm	L	10,000	Paper	8mm	4mm
	D	1.6±0.20	0.8±0.20	0.8±0.20	T	4,000	Paper	8mm	4mm	L	10,000	Paper	8mm	4mm
					T	3,000	Plastic	8mm	4mm	L	10,000	Plastic	8mm	4mm
21	F	2.0±0.20	1.25±0.20	1.25±0.20	T	3,000	Plastic	8mm	4mm	L	10,000	Plastic	8mm	4mm
					T	2,500	Plastic	8mm	4mm	L	5,000	Plastic	8mm	4mm
316	B	3.2±0.20	1.6±0.15	1.6±0.15	T	2,500	Plastic	8mm	4mm	L	5,000	Plastic	8mm	4mm
					T	2,500	Plastic	8mm	4mm	L	5,000	Plastic	8mm	4mm
32	A	3.2±0.30	2.5±0.20	2.5±0.20	T	1,000	Plastic	8mm	4mm	L	4,000	Plastic	8mm	4mm



X6S/X6T Dielectric

•Capacitance chart Standard Spec.2 Optional Spec.

Table with columns: Size (EIA Code), CM03 (0201), CM105 (0603), CM21 (0805), CM03 (0201). Rows include capacitance values (105, 225, 475, 106, 226, 476, 107) and dimensions (E10, D8, D9, F7, F8).

Table with columns: Tan δ Code, Tan δ. Rows: 7 (10.0% max.), 8 (12.5% max.), 9 (15.0% max.), 10 (20.0% max.).

< Standard Capacitor Value : E3 Series >

Please contact for capacitance value other than standard.

Please refer here for the test method and specifications of Standard Specification 2.

Two digits alphanumeric in capacitance chart denote dimensions and tan δ. Please refer to the above table for detail.

(Example) In case of "D9" for CM105;

L: 1.6±0.20mm, W: 0.8±0.20mm, T: 0.8±0.20mm, Tanδ: 15.0% max.

Table with columns: Size, Dimension Code, Dimension (mm) [L, W, T], Packaging [φ180 Reel, φ330 Reel]. Rows: 03, 105, 21.

X7R Dielectric

•Capacitance chart Standard Spec.1 Standard Spec.2

Table with columns: Size (EIA Code), CM02 (01005), CM03 (0201), CM05 (0402), CM105 (0603), CM21 (0805). Rows include capacitance values (101, 151, 221, 331, 471, 681, 102, 152, 222, 332, 472, 682, 103, 153, 223, 333, 473, 683, 104, 224, 474, 105, 225, 475, 106) and dimensions (A8, B3, C8, B8, B3, F8).

Table with columns: Size (EIA Code), CM316 (1206), CM32 (1210). Rows include capacitance values (225, 475, 106, 226) and dimensions (B8, B5, B8, B3, B3, A8, A8, A3).

<Standard Capacitance Value>

Capacitance value of less than 0.1μF: E6 Series / Capacitance value of 0.1μF and larger : E3 Series

Please contact for capacitance value other than standard.

Please refer here for the test method and specifications of Standard Specification 1.

Please refer here for the test method and specifications of Standard Specification 2.

Two digits alphanumeric in capacitance chart denote dimensions and tan δ. Please refer to the above table for detail.

(Example) In case of "B3" for CM03;

L: 0.6±0.03mm, W: 0.3±0.03mm, T: 0.3±0.03mm, Tanδ: 5.0% max.

Table with columns: Tan δ Code, Tan δ. Rows: 3 (5.0% max.), 5 (7.5% max.), 8 (12.5% max.).

Table with columns: Size, Dimension Code, Dimension (mm) [L, W, T], Packaging [φ180 Reel, φ330 Reel]. Rows: 02, 03, 05, 105, 21, 316, 32.



X7S/X7T Dielectric

●Capacitance chart Standard Spec.1 Standard Spec.2

Size (EIA Code)	X7S				X7T			
	CM05 (0402)	CM21 (0805)	CM316 (1206)		CM105 (0603)	CM21 (0805)		
Rated Voltage (Vdc) Capacitance	4	6.3	100	10	100	6.3	10	6.3
105 1.0 μF	C8	C8	F3					
225 2.2 μF	E3				B3			
475 4.7 μF					C3		D8	
106 10 μF						D9		
226 22 μF				B5				F8

Please refer [here](#) for the test method and specifications of Standard Specification 1.
Please refer [here](#) for the test method and specifications of Standard Specification 2.

Two digits alphanumeric in capacitance chart denote dimensions and tan δ. Please refer to the above table for detail.

(Example) In case of "D9" for CM105;

L: 1.6±0.20mm, W: 0.8±0.20mm, T: 0.8±0.20mm, Tanδ: 15.0% max.

Tan δCode	Tan δ
3	5.0% max.
5	7.5% max.
8	12.5% max.
9	15.0% max.

Size	Dimension Code	Dimension (mm)			Packaging									
		L	W	T	φ180 Reel					φ330 Reel				
					Code	Quantity	Taping Material	Taping Width	Cavity Pitch	Code	Quantity	Taping Material	Taping Width	Cavity Pitch
05	C	1.0±0.05	0.5±0.05	0.5±0.05	H	10,000	Paper	8mm	2mm	N	50,000	Paper	8mm	2mm
	E	1.0±0.15	0.5±0.15	0.5±0.15	H	10,000	Paper	8mm	2mm	N	40,000	Paper	8mm	2mm
105	D	1.6±0.20	0.8±0.20	0.8±0.20	T	4,000	Paper	8mm	4mm	L	10,000	Paper	8mm	4mm
21	F	2.0±0.20	1.25±0.20	1.25±0.20	T	3,000	Plastic	8mm	4mm	L	10,000	Plastic	8mm	4mm
316	B	3.2±0.20	1.6±0.20	1.6±0.20	T	2,500	Plastic	8mm	4mm	L	5,000	Plastic	8mm	4mm
	C	3.2±0.30	1.6±0.30	1.6±0.30	T	2,000	Plastic	8mm	4mm	—	—	—	—	—



Test Conditions and Standards

Test Conditions and Specifications for Temperature Compensation Type (CA Characteristics) CM / CU Series (Standard Spec.1)

Test Items		Test Conditions	Specifications									
Capacitance Value (C)		<table border="1"> <thead> <tr> <th>Capacitance</th> <th>Frequency</th> <th>Volt</th> </tr> </thead> <tbody> <tr> <td>C ≤ 1000pF</td> <td>1MHz ± 10%</td> <td rowspan="2">0.5 to 5Vrms</td> </tr> <tr> <td>C > 1000pF</td> <td>1kHz ± 10%</td> </tr> </tbody> </table>	Capacitance	Frequency	Volt	C ≤ 1000pF	1MHz ± 10%	0.5 to 5Vrms	C > 1000pF	1kHz ± 10%	Within tolerance	
Capacitance	Frequency		Volt									
C ≤ 1000pF	1MHz ± 10%	0.5 to 5Vrms										
C > 1000pF	1kHz ± 10%											
Q			C ≥ 30pF : Q ≥ 1000 C < 30pF : Q ≥ 400 + 20C									
Insulation Resistance (IR)		Apply the rated voltage for 1 minute, and measure it in normal temperature and humidity. The charge and discharge current of the capacitor must not exceed 50mA.	Over 10000MΩ or 500MΩ·μF, whichever is less									
Dielectric Resistance		Apply*3 times of the rated voltage for 1 to 5 seconds. *CU02CA2R20-120/25V: twice The charge and discharge current of the capacitor must not exceed 50mA.	No problem observed									
Appearance		Microscope	No problem observed									
Termination Strength		Apply a sideward force of 500g (5N) to a PCB-mounted sample. note: 2N for 0201 size, and 1N for 01005 size.	No problem observed									
Bending Strength		Glass epoxy PCB: Fulcrum spacing: 90mm, duration time 10 seconds.	No significant damage with 1mm bending.									
Vibration Test	Appearance	Vibration frequency: 10 to 55 (Hz) Amplitude: 1.5mm Sweeping condition: 10→55→10Hz/ 1 minute in X, Y and Z directions: 2 hours each, 6 hours in total.	No problem observed									
	ΔC		Within Tolerance									
	Q		C ≥ 30pF : Q ≥ 1000 C < 30pF : Q ≥ 400 + 20C									
Soldering Heat Resistant	Appearance	Soak the sample in 260°C ± 5°C solder for 10 ± 0.5 seconds and place in normal temperature and humidity, and measure the sample after 24 ± 2 hours. (Pre-heating conditions)	No problem observed									
	ΔC		Within ± 2.5% or ± 0.25pF, whichever is larger									
	Q		C ≥ 30pF : Q ≥ 1000 C < 30pF : Q ≥ 400 + 20C									
	IR		Over 10000MΩ or 500MΩ·μF whichever is less									
	Withstanding Voltage		The charge and discharge current of the capacitor must not exceed 50mA for IR and withstanding voltage measurement.									
Solderability		Soaking condition	Solder coverage : 95% min.									
		<table border="1"> <thead> <tr> <th>Order</th> <th>Temperature</th> <th>Time</th> </tr> </thead> <tbody> <tr> <td>1</td> <td>80 to 100°C</td> <td>2 minutes</td> </tr> <tr> <td>2</td> <td>150 to 200°C</td> <td>2 minutes</td> </tr> </tbody> </table>	Order	Temperature	Time	1	80 to 100°C	2 minutes	2	150 to 200°C	2 minutes	
Order	Temperature	Time										
1	80 to 100°C	2 minutes										
2	150 to 200°C	2 minutes										
Temperature Cycle	Appearance	(Cycle) Room temperature (3 min.)→ Lowest operation temperature (30 min.)→ Room temperature (3 min.)→ Highest operation temperature(30 min.) After 5 cycles, measure after 24 ± 2 hours. The charge and discharge current of the capacitor must not exceed 50mA for IR and withstanding voltage measurement.	No problem observed									
	ΔC		Within ± 2.5% or ± 0.25pF, whichever is larger									
	Q		C ≥ 30pF : Q ≥ 1000 C < 30pF : Q ≥ 400 + 20C									
	IR		Over 10000MΩ or 500MΩ·μF, whichever is less									
	Withstanding Voltage		Resist without problem									
Moisture Resistant Load	Appearance	After applying the rated voltage for 500 + 12/ - 0 hours in the condition of 40°C ± 2°C and 90 to 95%RH, allow the parts to stabilize in normal temperature and humidity for 24 ± 2 hours, before measurement. The charge and discharge current of the capacitor must not exceed 50mA for IR measurement.	No problem observed									
	ΔC		Within ± 7.5% or ± 0.75pF, whichever is larger									
	Q		C ≥ 30pF : Q ≥ 200 C < 30pF : Q ≥ 100 + 10C / 3									
	IR		Over 500MΩ or 25MΩ·μF, whichever is less									
High-Temperature Load	Appearance	After applying *twice the rated voltage in the temperature of 125 ± 3°C for 1000 + 12/ - 0 hours, measure the sample after 24 ± 2 hours in normal temperature and humidity. The charge and discharge current of the capacitor must not exceed 50mA for IR measurement. *Applied voltages for respective products are indicated in the chart below.	No problem observed.									
	ΔC		Within ± 3% or ± 0.3pF, whichever is larger									
	Q		C ≥ 30pF : Q ≥ 350 10pF < C < 30pF : Q ≥ 275 + 5C / 2 C < 10pF : Q ≥ 200 + 10C									
	IR		Over 1000MΩ or 50MΩ·μF, whichever is less									

Please ask for individual specification for the hatched range in previous chart.

Voltage to be applied in the High Temperature Load (Applied voltage is the multiple of the rated volatage)

Applied Voltage	Rated Voltage	Products
× 1.0	16V	CM02CA221
× 1.2	25V	CM02CAR20-120



Test Conditions and Standards

Test Conditions and Specifications for High Dielectric Type (X5R, X7R, X7S) CM / CT Series (Standard Spec.1)

Test Items		Test Conditions	Specifications												
Capacitance Value (C)		Measure after heat treatment	Within tolerance												
Tanδ		<table border="1"> <thead> <tr> <th>Capacitance</th> <th>Frequency</th> <th>Volt</th> </tr> </thead> <tbody> <tr> <td>C ≤ 10μF</td> <td>1kHz±10%</td> <td>1.0±0.2Vrms</td> </tr> <tr> <td>C > 10μF</td> <td>*1kHz±10%</td> <td>0.5±0.2Vrms</td> </tr> <tr> <td></td> <td>120Hz±10%</td> <td>0.5±0.2Vrms</td> </tr> </tbody> </table>	Capacitance	Frequency	Volt	C ≤ 10μF	1kHz±10%	1.0±0.2Vrms	C > 10μF	*1kHz±10%	0.5±0.2Vrms		120Hz±10%	0.5±0.2Vrms	Refer to capacitance chart
	Capacitance	Frequency	Volt												
C ≤ 10μF	1kHz±10%	1.0±0.2Vrms													
C > 10μF	*1kHz±10%	0.5±0.2Vrms													
	120Hz±10%	0.5±0.2Vrms													
		*CM02X5R104□06A# The charge and discharge current of the capacitor must not exceed 50mA.													
Insulation Resistance (IR)		Apply the rated voltage for 1 minute, and measure it in normal temperature and humidity. The charge and discharge current of the capacitor must not exceed 50mA.	Over 10000MΩ or 500MΩ·μF, whichever is less												
Dielectric Resistance		Apply *2.5 times of the rated voltage for 1 to 5 seconds. *CM316X5R225, CM316X7S225/100V: twice The charge and discharge current of the capacitor must not exceed 50mA.	No problem observed												
Appearance		Microscope	No problem observed												
Termination Strength		Apply a sideward force of 500g (5N) to a PCB-mounted sample. note : 2N for 0201 size, and 1N for 01005 size. Exclude CT series with thickness of less than 0.66mm.	No problem observed												
Bending Strength		Glass epoxy PCB: Fulcrum spacing: 90mm, duration time 10 seconds. Exclude CT series with thickness of less than 0.66mm.	No significant damage with 1mm bending												
Vibration Test	Appearance	Take the initial value after heat treatment. Vibration frequency: 10 to 55 (Hz) Amplitude: 1.5mm	No problem observed												
	ΔC	Sweeping condition: 10→55→10Hz/ 1 minute in X, Y and Z directions: 2 hours each, 6 hours in total, and place in normal temperature and humidity, then measure the sample after heat treatment.	Within tolerance												
	Tanδ		Within tolerance												
Soldering Heat Resistant	Appearance	Take the initial value after heat treatment. Soak the sample in 260°C±5°C solder for 10±0.5 seconds and place in normal temperature and humidity, and measure after heat treatment. (Pre-heating conditions)	No problem observed												
	ΔC		Within±7.5%												
	Tanδ		Within tolerance												
	IR	<table border="1"> <thead> <tr> <th>Order</th> <th>Temperature</th> <th>Time</th> </tr> </thead> <tbody> <tr> <td>1</td> <td>80 to 100°C</td> <td>2 minutes</td> </tr> <tr> <td>2</td> <td>150 to 200°C</td> <td>2 minutes</td> </tr> </tbody> </table>	Order	Temperature	Time	1	80 to 100°C	2 minutes	2	150 to 200°C	2 minutes	Over 10000MΩ or 500MΩ·μF, whichever is less			
	Order	Temperature	Time												
1	80 to 100°C	2 minutes													
2	150 to 200°C	2 minutes													
Withstanding Voltage	The charge and discharge current of the capacitor must not exceed 50mA for IR and withstanding voltage measurement.	Resist without problem													
Solderability		Soaking condition <table border="1"> <thead> <tr> <th>Sn-3Ag-0.5Cu</th> <th>245±5°C</th> <th>3±0.5 sec.</th> </tr> </thead> <tbody> <tr> <th>Sn63 Solder</th> <th>235±5°C</th> <th>2±0.5 sec.</th> </tr> </tbody> </table>	Sn-3Ag-0.5Cu	245±5°C	3±0.5 sec.	Sn63 Solder	235±5°C	2±0.5 sec.	Solder coverage : 95% min.						
Sn-3Ag-0.5Cu	245±5°C	3±0.5 sec.													
Sn63 Solder	235±5°C	2±0.5 sec.													
Temperature Cycle	Appearance	Take the initial value after heat treatment. (Cycle)	No problem observed												
	ΔC	Room temperature (3 min.)→	Within±7.5%												
	Tanδ	Lowest operation temperature (30 min.)→	Within tolerance												
	IR	Room temperature (3 min.)→ Highest operation temperature(30 min.)	Over 10000MΩ or 500MΩ·μF, whichever is less												
	Withstanding Voltage	After 5 cycles, measure after heat treatment. The charge and discharge current of the capacitor must not exceed 50mA for IR and withstanding voltage measurement.	Resist without problem												
Moisture Resistant Load	Appearance	Take the initial value after heat treatment. After applying rated voltage for 500+12/ -0 hours in the condition of 40°C±2°C and 90 to 95%RH, and place in normal temperature and humidity, then measure the sample after heat treatment. The charge and discharge current of the capacitor must not exceed 50mA for IR measurement.	No problem observed												
	ΔC		Within±12.5%												
	Tanδ		200% max. of initial value												
	IR		Over 500MΩ or 25MΩ·μF, whichever is less												
High-Temperature Load	Appearance	Take the initial value after heat treatment. After applying *twice the rated voltage at the highest operation temperature for 1000+12/ -0 hours, and measure the sample after heat treatment in normal temperature and humidity. The charge and discharge current of the capacitor must not exceed 50mA for IR measurement. *Apply 1.5 times when the rated voltage is 10V or less. Applied voltages for respective products are indicated in the chart below.	No problem observed												
	ΔC		Within±12.5%												
	Tanδ		200% max. of initial value												
	IR		Over 1000MΩ or 50MΩ·μF, whichever is less												
Heat treatment		Expose sample in the temperature of 150+0/ -10°C for 1 hour and leave the sample in normal temperature and humidity for 24±2 hours.													

Voltage to be applied in the High Temperature Load (Applied voltage is the multiple of the rated voltage)

Applied Voltage	Rated Voltage	Products
×1.0	10V	CM02X5R104
	100V	CM316X5R225, CM316X7S225
×1.3	6.3V	CM02X5R153-104, CT03X5R104
	16V	CM02X5R101-103, CM05X5R224, CM105X5R225, CM21X5R106, CM316X5R226, CM02X7R101-222, CM105X7R105, CM316X7R106, CM32X7R226, CT105X5R105, CT21X5R475
×1.5	25V	CM03X5R332-103, CM105X5R105, CM21X5R225-475, CM316X5R106, CM32X5R106-226, CM05X7R104, CM21X7R105-225, CM316X7R475, CM32X7R106
	50V	CM21X5R105, CM316X5R475, CM32X5R106, CM21X7R105, CM32X7R106, CT21X5R225,

Please contact us for the optional specifications of the capacitance chart.



Test Conditions and Standards

Test Conditions and Specifications for High Dielectric Type (X5R, X6S, X7R, X7S, X7T) CM / CT Series (Standard Spec.2)

Test Items		Test Conditions	Specifications												
Capacitance Value (C)		Measure after heat treatment	Within tolerance												
Tanδ		<table border="1"> <thead> <tr> <th>Capacitance</th> <th>Frequency</th> <th>Volt</th> </tr> </thead> <tbody> <tr> <td>C ≤ 10μF</td> <td>1kHz±10%</td> <td>1.0±0.2Vrms</td> </tr> <tr> <td></td> <td>*1kHz±10%</td> <td>0.5±0.2Vrms</td> </tr> <tr> <td>C > 10μF</td> <td>120Hz±10%</td> <td>0.5±0.2Vrms</td> </tr> </tbody> </table>	Capacitance	Frequency	Volt	C ≤ 10μF	1kHz±10%	1.0±0.2Vrms		*1kHz±10%	0.5±0.2Vrms	C > 10μF	120Hz±10%	0.5±0.2Vrms	Refer to capacitance chart
	Capacitance	Frequency	Volt												
C ≤ 10μF	1kHz±10%	1.0±0.2Vrms													
	*1kHz±10%	0.5±0.2Vrms													
C > 10μF	120Hz±10%	0.5±0.2Vrms													
	*CM02X5R474M06A#, CM03X5R225□06A#, CM03X5R225M06A#035, CM03X5R475M06A#055, CM03X5R475M04A#, CM05X5R106M06A#, CT05X5R475M06A#033 The charge and discharge current of the capacitor must not exceed 50mA.														
Insulation Resistance (IR)		Apply the rated voltage for 1minute, and measure it in normal temperature and humidity. The charge and discharge current of the capacitor must not exceed 50mA.	Over 50MΩ·μF												
Dielectric Resistance		Apply *2.5 times of the rated voltage for 1 to 5 seconds. *CM21X7S105, CM316X7S475/100V: twice The charge and discharge current of the capacitor must not exceed 50mA.	No problem observed												
Appearance		Microscope	No problem observed												
Termination Strength		Apply a sideward force of 500g (5N) to a PCB-mounted sample. note : 2N for 0201 size, and 1N for 01005 size. Exclude CT series with thickness of less than 0.66mm.	No problem observed												
Bending Strength		Glass epoxy PCB: Fulcrum spacing: 90mm, duration time 10 seconds. Exclude CT series with thickness of less than 0.66mm.	No significant damage with 1mm bending												
Vibration Test	Appearance	Take the initial value after heat treatment. Vibration frequency: 10 to 55 (Hz) Amplitude: 1.5mm	No problem observed												
	ΔC	Sweeping condition: 10→55→10Hz/ 1 minute in X, Y and Z directions: 2 hours each, 6 hours in total, and place in normal temperature and humidity, then measure the sample after heat treatment.	Within tolerance												
	Tanδ		Within tolerance												
Soldering Heat Resistant	Appearance	Take the initial value after heat treatment. Soak the sample in 260°C±5°C solder for 10±0.5 seconds and place in normal temperature and humidity, and measure after heat treatment. (Pre-heating conditions)	No problem observed												
	ΔC		Within±7.5%												
	Tanδ		Within tolerance												
	IR	<table border="1"> <thead> <tr> <th>Order</th> <th>Temperature</th> <th>Time</th> </tr> </thead> <tbody> <tr> <td>1</td> <td>80 to 100°C</td> <td>2 minutes</td> </tr> <tr> <td>2</td> <td>150 to 200°C</td> <td>2 minutes</td> </tr> </tbody> </table>	Order	Temperature	Time	1	80 to 100°C	2 minutes	2	150 to 200°C	2 minutes	Over 50MΩ·μF			
	Order	Temperature	Time												
1	80 to 100°C	2 minutes													
2	150 to 200°C	2 minutes													
Withstanding Voltage	The charge and discharge current of the capacitor must not exceed 50mA for IR and withstanding voltage measurement.	Resist without problem													
Solderability		Soaking condition	Solder coverage : 95% min.												
Temperature Cycle	Appearance	Take the initial value after heat treatment. (Cycle)	No problem observed												
	ΔC	Room temperature (3 min.)→Lowest operation temperature (30 min.)→Room temperature (3 min.)→Highest operation temperature(30 min.)	Within±7.5%												
	Tanδ	After 5 cycles, measure after heat treatment. The charge and discharge current of the capacitor must not exceed 50mA for IR and withstanding voltage measurement.	Within tolerance												
	IR		Over 50MΩ·μF												
	Withstanding Voltage		Resist without problem												
Moisture Resistant Load	Appearance	Take the initial value after heat treatment.	No problem observed												
	ΔC	After applying rated voltage for 500+12/-0 hours in the condition of 40°C±2°C and 90 to 95%RH, and place in normal temperature and humidity, then measure the sample after heat treatment. The charge and discharge current of the capacitor must not exceed 50mA for IR measurement.	Within±12.5%												
	Tanδ		200% max. of initial value												
	IR		Over 10MΩ·μF												
High-Temperature Load	Appearance	Take the initial value after heat treatment.	No problem observed												
	ΔC	After applying *□ times the rated voltage at the highest operation temperature for 1000+12/-0 hours, and measure the sample after heat treatment in normal temperature and humidity. The charge and discharge current of the capacitor must not exceed 50mA for IR measurement.	Within±12.5%												
	Tanδ	*Apply 1.0 times when the rated voltage is 4V or less. Applied voltages for respective products are indicated in the chart below.	200% max. of initial value												
	IR		Over 10MΩ·μF												
Heat treatment		Expose sample in the temperature of 150+0/-10°C for 1 hour and leave the sample in normal temperature and humidity for 24±2 hours.													

Voltage to be applied in the High Temperature Load (Applied voltage is the multiple of the rated voltage)

Applied Voltage	Rated Voltage	Products	Applied Voltage	Rated Voltage	Products	
×1.0	6.3V	CM02X5R224, CM02X5R474, CM03X5R225, CM03X5R475, CM05X5R106	×1.2	6.3V	CM03X5R105	
		CM05X5R156, CM05X5R226, CM21X5R476, CM03X6S105, CM105X6S226			6.3V	CM03X5R474
		CT05X5R105, CT05X5R225, CT05X5R475	×1.3	10V	CM03X5R223-224, CM05X5R105-225	
	CM03X5R225, CM105X5R226, CM21X6S226	16V			CM05X5R105	
	×1.5	16V	CM03X5R105, CM05X5R225, CM05X5R475, CM105X5R226	6.3V	6.3V	CM21X6S226, CM05X7S105
			CM21X6S226, CM21X7R475			CM105X7T106, CM21X7T226
		25V	CM05X5R105, CM05X5R225, CM05X5R475, CM105X5R475	10V	10V	CM05X5R474, CM05X5R475, CM21X5R226
			CM105X5R106, CM21X5R226			CM105X6S106, CM105X7T475
			CM05X5R105, CM105X5R475, CM105X5R106			25V
		100V	CM21X7S105, CM316X7S475	50V	50V	CM316X7R475

Please contact us for the optional specifications of the capacitance chart.



Test Conditions and Standards

Substrate for Adhesion Strength Test, Vibration Test, Soldering Heat Resistance Test, Temperature Cycle Test, Load Humidity Test, High-Temperature with Loading Test.

(Unit: mm)

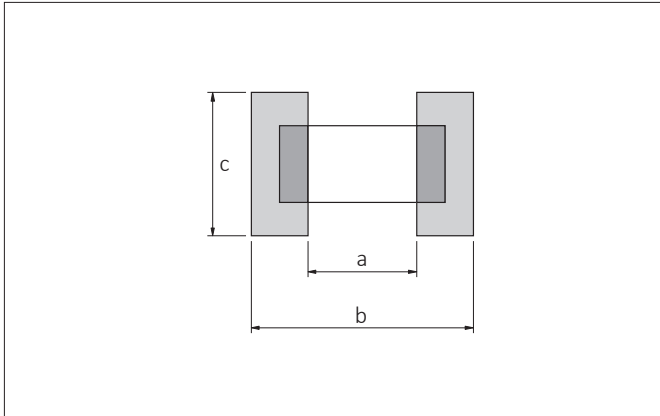

Size (EIA Code)	a	b	c
02 (01005)	0.15	0.50	0.20
03 (0201)	0.26	0.92	0.32
05 (0402)	0.4	1.4	0.5
105 (0603)	1.0	3.0	1.2
21 (0805)	1.2	4.0	1.65
316 (1206)	2.2	5.0	2.0
32 (1210)	2.2	5.0	2.9

Substrate for Bending Test

(Unit: mm)

Testing Board : Glass Epoxy Board (CE4 or FR4)
 Testing Board Thickness : 1.6±0.2mm*
 Circuit Thickness : 0.04±0.01mm

*02, 03, 05 size 0.8±0.1mm

Structure

Plated Termination

Internal Electrodes (Pd or Ni or Cu)
 Dielectric Ceramic Layer
 Temperature compensation:
 Titanate family
 Zirconate family
 High dielectric constant:
 Barium Titanate family

External Termination Electrodes (Ag or Cu or CuNi)
 Ni Plating
 Sn Plating

About official Standards Certification

- The sites that manufacture the products listed in this catalog have acquired ISO 9001 quality management system (certification).
- The production site is Kagoshima Kokubu Plant.



Packaging Options Tape and Reel

Reel

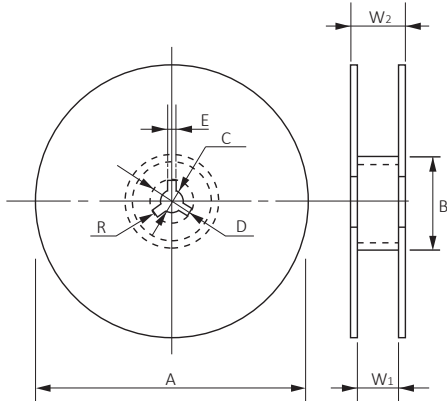

(Unit: mm)

Code Reel	A	B	C	D
7-inch Reel (CODE: T, H, Q)	180 $^{+0}_{-2.0}$	φ60 min.	13±0.5	21±0.8
7-inch Reel (CODE: P)	178±2.0			
13-inch Reel (CODE: L, N, W)	330±2.0			
Code Reel	E	W1	W2	R
7-inch Reel (CODE: T, H, Q)	2.0±0.5	10.5±1.5	16.5 max.	1.0
7-inch Reel (CODE: P)		4.35±0.3	6.95±1.0	
13-inch Reel (CODE: L, N, W)		9.5±1.0	16.5 max.	

Carrier Tape

(Unit: mm)

F=1mm (02 Size)

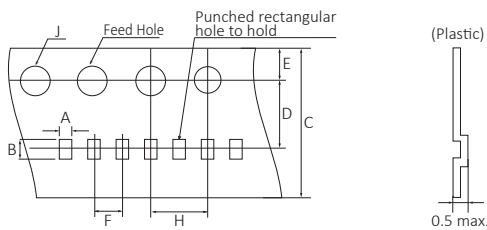

F=2mm (02, 03, 05 Size)

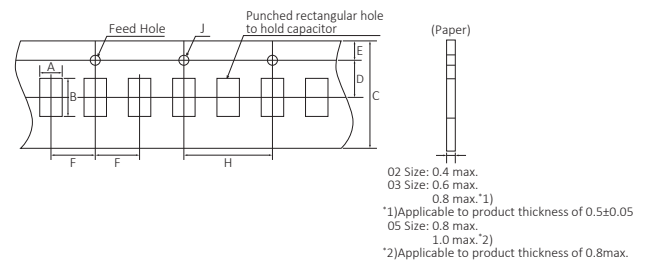

F=1mm (02, 03, 05 Size)

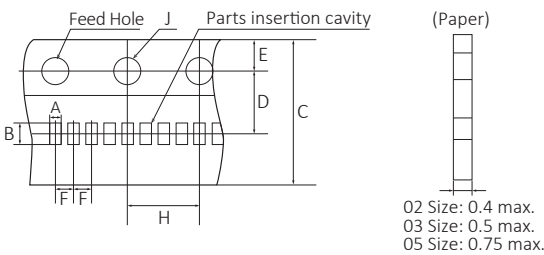

F=4mm (105, 21, 316, 32 Size)

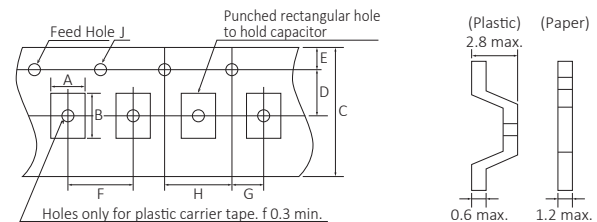

(Unit: mm)

Size (EIA Code)	A	B	C	D	E	F	G	H	J	Carrier Tape	
										Width	Material
02 (01005)*	0.24±0.02	0.44±0.02	4.0±0.08	1.8±0.02	0.9±0.05	1.0±0.02	—	2.0±0.04	0.8±0.04	4mm	Plastic
	0.25±0.03	0.45±0.03	8.0±0.3	3.5±0.05	1.75±0.1	2.0±0.05	—	4.0±0.1	1.5±0.1/-0	8mm	Paper
03 (0201)*	0.37±0.03	0.67±0.03	8.0+0.3/-0.1	3.5±0.05	1.75±0.1	1.0±0.05	—	4.0±0.05	1.5±0.1/-0	8mm	Paper
			8.0±0.3			2.0±0.05		4.0±0.1			
	0.39±0.03	0.69±0.03	8.0±0.3	3.5±0.05	1.75±0.1	2.0±0.05	—	4.0±0.1	1.5±0.1/-0		
	0.42±0.03	0.72±0.03	8.0±0.3	3.5±0.05	1.75±0.1	2.0±0.05	—	4.0±0.1	1.5±0.1/-0		
	0.44±0.05	0.74±0.05	8.0±0.3	3.5±0.05	1.75±0.1	2.0±0.05	—	4.0±0.1	1.5±0.1/-0		
05 (0402)*	0.65±0.1	1.15±0.1	8.0+0.3/-0.1	3.5±0.05	1.75±0.1	1.0±0.05	—	4.0±0.05	1.5±0.1/-0	8mm	Paper
	0.75±0.1		8.0±0.3			2.0±0.05		4.0±0.1			
	0.8±0.1	1.3±0.1	8.0±0.3	3.5±0.05	1.75±0.1	2.0±0.05	—	4.0±0.1	1.5±0.1/-0		
105 (0603)*	1.0±0.2	1.8±0.2	8.0±0.3	3.5±0.05	1.75±0.1	4.0±0.1	2.0±0.05	4.0±0.1	1.5±0.1/-0	8mm	Paper
	1.1±0.2	1.9±0.2	8.0±0.3	3.5±0.05	1.75±0.1	4.0±0.1	2.0±0.05	4.0±0.1	1.5±0.1/-0		
21 (0805)	1.5±0.2	2.3±0.2	8.0±0.3	3.5±0.05	1.75±0.1	4.0±0.1	2.0±0.05	4.0±0.1	1.5±0.1/-0	8mm	Paper
										8mm	Plastic
316 (1206)	2.0±0.2	3.6±0.2	8.0±0.3	3.5±0.05	1.75±0.1	4.0±0.1	2.0±0.05	4.0±0.1	1.5±0.1/-0	8mm	Paper
										8mm	Plastic
32 (1210)	2.9±0.2	3.6±0.2	8.0±0.3	3.5±0.05	1.75±0.1	4.0±0.1	2.0±0.05	4.0±0.1	1.5±0.1/-0	8mm	Plastic

* Option



Packaging Options

Detail of leader and trailer

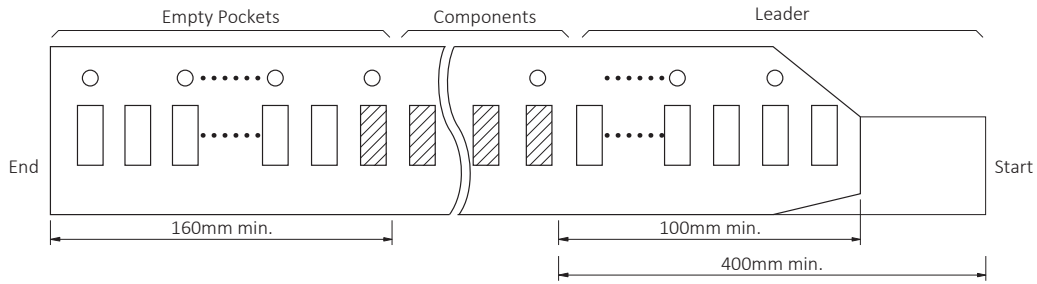

Adhesive tape

- 1) The exfoliative strength when peeling off the top tape from the carrier tape by the method of the following figure shall be *0.1 to 0.7N. *02 Size: 0.1 to 0.5N
- 2) When the top tape is peeled off, the adhesive stays on the top tape.
- 3) Chip capacitors will be in a state free without being stuck on the thermal adhesive tape.

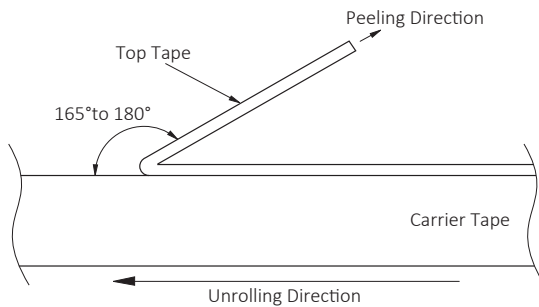

Exfoliating angle: 165 to 180 degrees to the carrier tape.
Exfoliating speed: 300 mm/min.

Carrier tape

- 1) Chip will not fall off from carrier tape or carrier tape will not be damaged by bending than within a radius of 25mm.
- 2) The chip are inserted continuously without any empty pocket.
- 3) Chip will not be mis-mounted because of too big clearance between components and cavity. Also the waste of carrier tape will not fill a nozzle hole of mounting machine.



Surface Mounting Information

Dimensions for recommended typical land

Since the amount of solder (size of fillet) to be used has direct influence on the capacitor after mounting, the sufficient consideration is necessary.

When the amounts of solder is too much, the stress that a capacitor receives becomes larger. It may become the cause of a crack in the capacitor. When the land design of printed wiring board is considered, it is necessary to set up the form and size of land pattern so that the amount of solder is suitable.

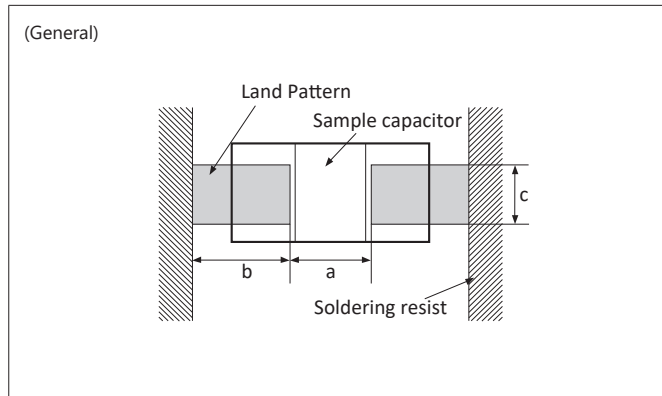

General

(Unit: mm)

Size (EIA Code)	Dimension		Recommended land dimensions		
	L	W	a	b	c
02 (01005)	0.4±0.02	0.2±0.02	0.13 to 0.20	0.12 to 0.18	0.20 to 0.23
	0.6±0.03	0.3±0.03	0.20 to 0.25	0.25 to 0.35	0.30 to 0.40
03 (0201)	0.6±0.05	0.3±0.05	0.23 to 0.30	0.25 to 0.35	0.30 to 0.45
	0.6±0.09	0.3±0.09	0.30 to 0.50	0.35 to 0.45	0.40 to 0.60
05 (0402)	1.0±0.05	0.5±0.05	0.40 to 0.60	0.40 to 0.50	0.50 to 0.75
	1.0±0.20	0.5±0.20	0.70 to 1.00	0.80 to 1.00	0.60 to 0.90
105 (0603)	1.6±0.10	0.8±0.10	0.80 to 1.00	0.80 to 1.00	0.80 to 1.10
	1.6±0.15	0.8±0.15			
	1.6±0.20	0.8±0.20			
	1.6±0.25	0.8±0.25			
21 (0805)	2.0±0.10	1.25±0.10	1.00 to 1.30	1.00 to 1.20	1.00 to 1.45
	2.0±0.15	1.25±0.15			
	2.0±0.20	1.25±0.20			
316 (1206)	3.2±0.20	1.6±0.15	2.10 to 2.50	1.10 to 1.30	1.40 to 1.90
	3.2±0.20	1.6±0.20			
	3.2±0.30	1.6±0.30			
32 (1210)	3.2±0.30	2.5±0.20	2.10 to 2.50	1.10 to 1.30	1.90 to 2.80

* Recommended land dimensions may differ depending on dimensional tolerance.

Design of printed circuit and Soldering

The recommended fillet height shall be 1/2 of the thickness of capacitors or 0.5mm. When mounting two or more capacitors in the common land, it is necessary to separate the land with the solder resist strike so that it may become the exclusive land of each capacitor.

Ideal Solder Height

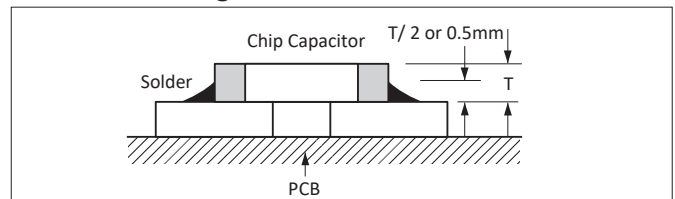

Item	Prohibited	Recommended example : Separation by solder resist
Multiple parts mount		
Mount with leaded parts		
Wire soldering after mounting		
Side by side layout		



Surface Mounting Information

Mounting Design

The chip could crack if the PCB warps during processing after the chip has been soldered.

Recommended chip position on PCB to minimize stress from PCB warpage



Actual Mounting

- 1) If the position of the vacuum nozzle is too low, a large force may be applied to the chip capacitor during mounting, resulting in cracking.
- 2) During mounting, set the nozzle pressure to a static load of 1 to 3 N.
- 3) To minimize the shock of the vacuum nozzle, provide a support pin on the back of the PCB to minimize PCB flexure.

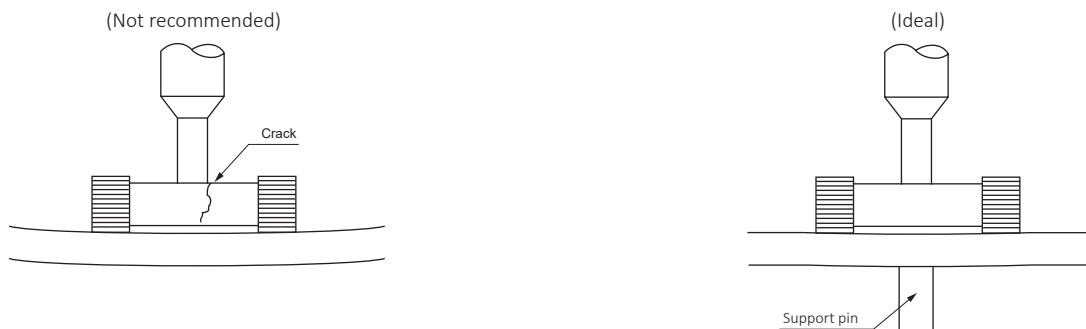

- 4) Bottom position of pick up nozzle should be adjusted to the top surface of a substrate which camber is corrected.

Resin Mold

- 1) If a large amount of resin is used for molding the chip, cracks may occur due to contraction stress during curing. To avoid such cracks, use a low shrinkage resin.
- 2) The insulation resistance of the chip will degrade due to moisture absorption. Use a low moisture absorption resin.
- 3) Check carefully that the resin does not generate a decomposition gas or reaction gas during the curing process or during normal storage. Such gases may crack the chip capacitor or damage the device itself.



Surface Mounting Information

Soldering Method

- 1) Ceramic is easily damaged by rapid heating or cooling. If some heat shock is unavoidable, preheat enough to limit the temperature difference (Delta T) to within 150 degree Celsius.
- 2) The product size 1.6×0.8mm to 3.2×1.6mm can be used in reflow and wave soldering, and the product size of bigger than 3.2×1.6mm, or smaller than 1.6×0.8mm can be used in reflow.
Circuit shortage and smoking can be created by using capacitors which are used neglecting the above caution.
- 3) Please see our recommended soldering conditions.
- 4) In case of using Sn-Zn Solder, please contact us in advance.
- 5) The following condition is recommended for spot heater application.

Recommended spot heater condition

Item	Condition
Distance	5mm min.
Angle	45°
Projection Temp.	400°C max.
Flow rate	Set at the minimum
Nozzle diameter	2φ to 4φ (Single hole type)
Application time	10 sec. max. (1206 and smaller) 30 sec. max. (1210 and larger)

How to point spot heater

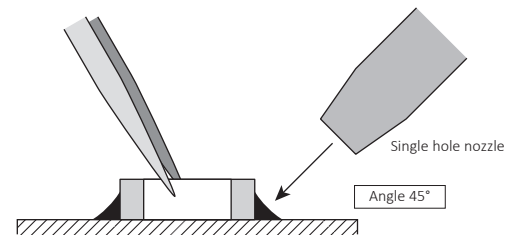

Recommended Temperature Profile (Sn-3Ag-0.5Cu)

Reflow

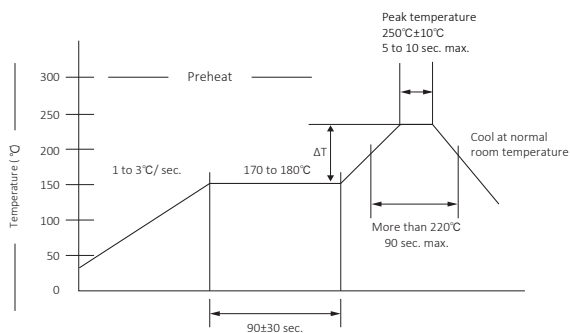

- ① Minimize soldering time.
- ② Ensure that allowable temperature difference does not exceed 150°C.
- ③ Ensure that allowable temperature difference does not exceed 130°C for 3.2×2.5mm size or larger.
- ④ MLCC can withstand the above reflow conditions up to 3 times.
- ⑤ N₂ atmosphere is recommended for reflow of products of 0.4mm×0.2mm size or smaller.

Wave

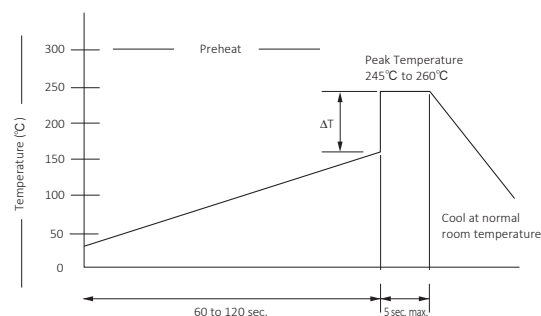

- ① Ensure that the chip capacitor is preheated adequately.
- ② Ensure that the temperature difference (ΔT) does not exceed 150°C.
- ③ Cool naturally after soldering.
- ④ Wave soldering is not applicable for chips with size of 3.2×2.5mm or larger of 1.0×0.5mm or smaller and capacitor arrays.

Recommended Temperature Profile (63Sn Solder)

Reflow

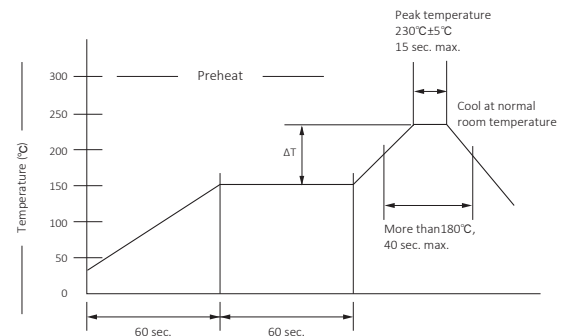

- ① Minimize soldering time.
- ② Ensure that the temperature difference (ΔT) does not exceed 150°C.
- ③ Ensure that the temperature difference (ΔT) does not exceed 130°C for 3.2×2.5mm size or larger.
- ④ MLCC can withstand the above reflow conditions up to 3 times.

Wave

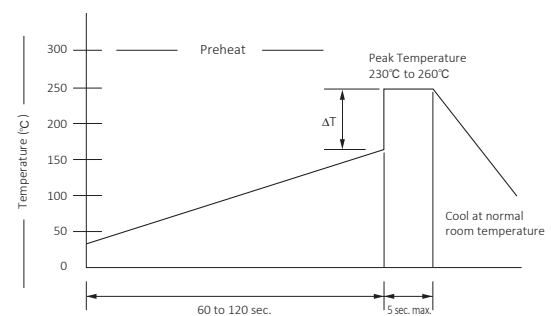

- ① Ensure that the chip capacitor is preheated adequately.
- ② Ensure that the temperature difference (ΔT) does not exceed 150°C.
- ③ Cool naturally after soldering.
- ④ Wave soldering is not applicable for chips with size of 3.2×2.5mm or larger of 1.0×0.5mm or smaller and capacitor arrays.



Precautions

Circuit Design

1. Once application and assembly environments have been checked, the capacitor may be used in conformance with the rating and performance which are provided in both the catalog and the specifications. Use exceeding that which is specified may result in inferior performance or cause a short, open, smoking, or flaming to occur, etc.
2. Please consult the manufacturer in advance when the capacitor is used in devices such as: devices which deal with human life, i.e. medical devices; devices which are highly public orientated; and devices which demand a high standard of liability.
Accident or malfunction of devices such as medical devices, space equipment and devices having to do with atomic power could generate grave consequence with respect to human lives or, possibly, a portion of the public. Capacitors used in these devices may require high reliability design different from that of general purpose capacitors.
3. Please use the capacitors in conformance with the operating temperature provided in both the catalog and the specifications.
Be especially cautious not to exceed the maximum temperature. In the situation the maximum temperature set forth in both the catalog and specifications is exceeded, the capacitor's insulation resistance may deteriorate, power may suddenly surge and short-circuit may occur.
The capacitor has a loss, and may self-heat due to equivalent series resistance when alternating electric current is passed therethrough. As this effect becomes especially pronounced in high frequency circuits, please exercise caution.
When using the capacitor in a (self-heating) circuit, please make sure the surface of the capacitor remains under the maximum temperature for usage. Also, please make certain temperature rises remain below 20°C.
4. Please keep voltage under the rated voltage which is applied to the capacitor. Also, please make certain the peak voltage remains below the rated voltage when AC voltage is super-imposed to the DC voltage.
In the situation where AC or pulse voltage is employed, ensure average peak voltage does not exceed the rated voltage.
Exceeding the rated voltage provided in both catalog and specifications may lead to defective withstanding voltage or, in worst case situations, may cause the capacitor to smoke or flame.
5. When the capacitor is to be employed in a circuit in which there is continuous application of a high frequency voltage or a steep pulse voltage, even though it is within the rated voltage, please inquire to the manufacturer.
In the situation the capacitor is to be employed using a high frequency AC voltage or a extremely fast rising pulse voltage, even though it is within the rated voltage, it is possible capacitor reliability will deteriorate.
6. It is a common phenomenon of high-dielectric products to have a deteriorated amount of static electricity due to the application of DC voltage.
Due caution is necessary as the degree of deterioration varies depending on the quality of capacitor materials, capacity, as well as the load voltage at the time of operation.
7. Do not use the capacitor in an environment where it might easily exceed the respective provisions concerning shock and vibration specified in the catalog and specifications.
In addition, it is a common piezo phenomenon of high dielectric products to have some voltage due to vibration or to have noise due to voltage change. Please contact sales in such case.
8. If the electrostatic capacity value of the delivered capacitor is within the specified tolerance, please consider this when designing the respective product in order that the assembled product function appropriately.
9. Please contact us upon using conductive adhesives.

Storage

Please note the following regarding the storage of delivered products.

1. Set the storage temperature to + 5 to + 40 °C and humidity to 20 ~ 70% RH. Other meteorological conditions are in accordance with classification 1 K2 of JIS C 60721 -3 -1.
2. Store in a place where corrosive gas (H₂S, SO₂, NO₂, Cl₂, etc.) does not exist in the atmosphere. Also, avoid exposure to salty moisture. In either case, this may cause oxidation corrosion of the terminal electrode, reducing solderability.

If you store the above delivered products according to the conditions listed above, it will satisfy the solderability standard for 6 months from the shipping date.

Safety application guideline and detailed information of electrical properties are also provided in kyocera web site;
URL: <https://ele.kyocera.com/en/product/capacitor/>



Part Number List



General CM02 Series Size (JIS Code) : 01005(0402) # Packaging Code (Packaging quantity) : H(20,000pcs.) / N(80,000pcs.) / P(40,000pcs.)

Dielectric code CΔ	Capacitance	□:Tolerance	Voltage [V]	Part Number	Q	Dimension			# Packaging Code (quantity)		
						L[mm]	W[mm]	T[mm]			
CG/CH	1.0pF	B:±0.1pF / C:±0.25pF	25	CM02CΔ1R0□25A#	420	0.4±0.02	0.2±0.02	0.2±0.02	H / N / P		
	1.5pF			CM02CΔ1R5□25A#	430	0.4±0.02	0.2±0.02	0.2±0.02	H / N / P		
	2.0pF			CM02CΔ2R0□25A#	440	0.4±0.02	0.2±0.02	0.2±0.02	H / N / P		
	3.0pF			CM02CΔ3R0□25A#	460	0.4±0.02	0.2±0.02	0.2±0.02	H / N / P		
	4.0pF			CM02CΔ4R0□25A#	480	0.4±0.02	0.2±0.02	0.2±0.02	H / N / P		
	5.0pF			CM02CΔ5R0□25A#	500	0.4±0.02	0.2±0.02	0.2±0.02	H / N / P		
	6.0pF	C:±0.25pF / D:±0.5pF	25	CM02CΔ6R0□25A#	520	0.4±0.02	0.2±0.02	0.2±0.02	H / N / P		
	7.0pF			CM02CΔ7R0□25A#	540	0.4±0.02	0.2±0.02	0.2±0.02	H / N / P		
	8.0pF			CM02CΔ8R0□25A#	560	0.4±0.02	0.2±0.02	0.2±0.02	H / N / P		
	9.0pF			CM02CΔ9R0□25A#	580	0.4±0.02	0.2±0.02	0.2±0.02	H / N / P		
	10pF			CM02CΔ100□25A#	600	0.4±0.02	0.2±0.02	0.2±0.02	H / N / P		
	12pF			J:±5% / K:±10%	25	CM02CΔ120□25A#	640	0.4±0.02	0.2±0.02	0.2±0.02	H / N / P
	15pF	CM02CΔ150□25A#	700			0.4±0.02	0.2±0.02	0.2±0.02	H / N / P		
	18pF	CM02CΔ180□25A#	760			0.4±0.02	0.2±0.02	0.2±0.02	H / N / P		
	22pF	CM02CΔ220□25A#	840			0.4±0.02	0.2±0.02	0.2±0.02	H / N / P		
	27pF	J:±5% / K:±10%	16			CM02CΔ270□16A#	940	0.4±0.02	0.2±0.02	0.2±0.02	H / N / P
	33pF					CM02CΔ330□16A#	1000	0.4±0.02	0.2±0.02	0.2±0.02	H / N / P
	39pF			CM02CΔ390□16A#	1000	0.4±0.02	0.2±0.02	0.2±0.02	H / N / P		
	47pF			CM02CΔ470□16A#	1000	0.4±0.02	0.2±0.02	0.2±0.02	H / N / P		
	56pF			CM02CΔ560□16A#	1000	0.4±0.02	0.2±0.02	0.2±0.02	H / N / P		
	68pF			CM02CΔ680□16A#	1000	0.4±0.02	0.2±0.02	0.2±0.02	H / N / P		
	82pF	J:±5% / K:±10%	16	CM02CΔ820□16A#	1000	0.4±0.02	0.2±0.02	0.2±0.02	H / N / P		
100pF	CM02CΔ101□16A#			1000	0.4±0.02	0.2±0.02	0.2±0.02	H / N / P			
220pF	CM02CΔ221□16A#			1000	0.4±0.02	0.2±0.02	0.2±0.02	H / N / P			

General CM03 Series Size (JIS Code) : 0201(0603) # Packaging Code (Packaging quantity) : H(15,000pcs.) / N(50,000pcs.) / Q(30,000pcs.) / W(150,000pcs.)

Dielectric code CΔ	Capacitance	□:Tolerance	Voltage [V]	Part Number	Q	Dimension			# Packaging Code (quantity)
						L[mm]	W[mm]	T[mm]	
CG/CH	1.0pF	B:±0.1pF / C:±0.25pF	50	CM03CΔ1R0□50A#	420	0.6±0.03	0.3±0.03	0.3±0.03	H / N / Q / W
	1.5pF			CM03CΔ1R5□50A#	430	0.6±0.03	0.3±0.03	0.3±0.03	H / N / Q / W
	2.0pF			CM03CΔ2R0□50A#	440	0.6±0.03	0.3±0.03	0.3±0.03	H / N / Q / W
	3.0pF			CM03CΔ3R0□50A#	460	0.6±0.03	0.3±0.03	0.3±0.03	H / N / Q / W
	4.0pF			CM03CΔ4R0□50A#	480	0.6±0.03	0.3±0.03	0.3±0.03	H / N / Q / W
	5.0pF			CM03CΔ5R0□50A#	500	0.6±0.03	0.3±0.03	0.3±0.03	H / N / Q / W
	6.0pF	C:±0.25pF / D:±0.5pF	50	CM03CΔ6R0□50A#	520	0.6±0.03	0.3±0.03	0.3±0.03	H / N / Q / W
	7.0pF			CM03CΔ7R0□50A#	540	0.6±0.03	0.3±0.03	0.3±0.03	H / N / Q / W
	8.0pF			CM03CΔ8R0□50A#	560	0.6±0.03	0.3±0.03	0.3±0.03	H / N / Q / W
	9.0pF			CM03CΔ9R0□50A#	580	0.6±0.03	0.3±0.03	0.3±0.03	H / N / Q / W
	10pF			CM03CΔ100□50A#	600	0.6±0.03	0.3±0.03	0.3±0.03	H / N / Q / W
	12pF			J:±5% / K:±10%	50	CM03CΔ120□50A#	640	0.6±0.03	0.3±0.03
	15pF	CM03CΔ150□50A#	700			0.6±0.03	0.3±0.03	0.3±0.03	H / N / Q / W
	18pF	CM03CΔ180□50A#	760			0.6±0.03	0.3±0.03	0.3±0.03	H / N / Q / W
	22pF	CM03CΔ220□50A#	840			0.6±0.03	0.3±0.03	0.3±0.03	H / N / Q / W
	27pF	CM03CΔ270□50A#	940			0.6±0.03	0.3±0.03	0.3±0.03	H / N / Q / W
	33pF	CM03CΔ330□50A#	1000			0.6±0.03	0.3±0.03	0.3±0.03	H / N / Q / W
	39pF	J:±5% / K:±10%	50	CM03CΔ390□50A#	1000	0.6±0.03	0.3±0.03	0.3±0.03	H / N / Q / W
	47pF			CM03CΔ470□50A#	1000	0.6±0.03	0.3±0.03	0.3±0.03	H / N / Q / W
	56pF			CM03CΔ560□50A#	1000	0.6±0.03	0.3±0.03	0.3±0.03	H / N / Q / W
	68pF			CM03CΔ680□50A#	1000	0.6±0.03	0.3±0.03	0.3±0.03	H / N / Q / W
	82pF			CM03CΔ820□50A#	1000	0.6±0.03	0.3±0.03	0.3±0.03	H / N / Q / W
100pF	CM03CΔ101□50A#			1000	0.6±0.03	0.3±0.03	0.3±0.03	H / N / Q / W	



Part Number List



General CM02 Series Size (JIS Code) : 01005(0402) # Packaging Code (Packaging quantity) : H(20,000pcs.) / N(80,000pcs.) / P(40,000pcs.)

Dielectric code	Capacitance	□:Tolerance	Voltage [V]	Part Number	Tanδ [%]	Dimension			# Packaging Code (quantity)
						L[mm]	W[mm]	T[mm]	
X5R	100pF	K:±10% / M:±20%	16	CM02X5R101□16A#	12.5	0.4±0.02	0.2±0.02	0.2±0.02	H / N / P
	150pF			CM02X5R151□16A#	12.5	0.4±0.02	0.2±0.02	0.2±0.02	H / N / P
	220pF			CM02X5R221□16A#	12.5	0.4±0.02	0.2±0.02	0.2±0.02	H / N / P
	330pF			CM02X5R331□16A#	12.5	0.4±0.02	0.2±0.02	0.2±0.02	H / N / P
	470pF			CM02X5R471□16A#	12.5	0.4±0.02	0.2±0.02	0.2±0.02	H / N / P
	680pF			CM02X5R681□16A#	12.5	0.4±0.02	0.2±0.02	0.2±0.02	H / N / P
	1000pF			CM02X5R102□16A#	12.5	0.4±0.02	0.2±0.02	0.2±0.02	H / N / P
	1500pF			CM02X5R152□16A#	12.5	0.4±0.02	0.2±0.02	0.2±0.02	H / N / P
	2200pF			CM02X5R222□16A#	12.5	0.4±0.02	0.2±0.02	0.2±0.02	H / N / P
	3300pF			CM02X5R332□16A#	12.5	0.4±0.02	0.2±0.02	0.2±0.02	H / N / P
	4700pF			CM02X5R472□16A#	12.5	0.4±0.02	0.2±0.02	0.2±0.02	H / N / P
	6800pF			CM02X5R682□16A#	12.5	0.4±0.02	0.2±0.02	0.2±0.02	H / N / P
	10000pF			CM02X5R103□16A#	12.5	0.4±0.02	0.2±0.02	0.2±0.02	H / N / P
	15000pF			CM02X5R153□06A#	12.5	0.4±0.02	0.2±0.02	0.2±0.02	H / N / P
	22000pF			CM02X5R223□06A#	12.5	0.4±0.02	0.2±0.02	0.2±0.02	H / N / P
	33000pF	CM02X5R333□06A#	12.5	0.4±0.02	0.2±0.02	0.2±0.02	H / N / P		
	47000pF	CM02X5R473□06A#	12.5	0.4±0.02	0.2±0.02	0.2±0.02	H / N / P		
	68000pF	CM02X5R683□06A#	12.5	0.4±0.02	0.2±0.02	0.2±0.02	H / N / P		
	0.10µF	K:±10% / M:±20%	10	CM02X5R104□10A#	12.5	0.4±0.02	0.2±0.02	0.2±0.02	H / N / P
			6.3	CM02X5R104□06A#	12.5	0.4±0.02	0.2±0.02	0.2±0.02	H / N / P
	0.22µF	K:±10% / M:±20%	6.3	CM02X5R224□06A#	12.5	0.4±0.02	0.2±0.02	0.2±0.02	H / N / P
	0.47µF	M:±20%		CM02X5R474M06A#	12.5	0.4±0.02	0.2±0.02	0.2±0.02	H / N / P
X7R	100pF	K:±10% / M:±20%	16	CM02X7R101□16A#	12.5	0.4±0.02	0.2±0.02	0.2±0.02	H / N / P
	150pF			CM02X7R151□16A#	12.5	0.4±0.02	0.2±0.02	0.2±0.02	H / N / P
	220pF			CM02X7R221□16A#	12.5	0.4±0.02	0.2±0.02	0.2±0.02	H / N / P
	330pF			CM02X7R331□16A#	12.5	0.4±0.02	0.2±0.02	0.2±0.02	H / N / P
	470pF			CM02X7R471□16A#	12.5	0.4±0.02	0.2±0.02	0.2±0.02	H / N / P
	680pF			CM02X7R681□16A#	12.5	0.4±0.02	0.2±0.02	0.2±0.02	H / N / P
	1000µF			CM02X7R102□16A#	12.5	0.4±0.02	0.2±0.02	0.2±0.02	H / N / P
	1500µF			CM02X7R152□16A#	12.5	0.4±0.02	0.2±0.02	0.2±0.02	H / N / P
	2200µF			CM02X7R222□16A#	12.5	0.4±0.02	0.2±0.02	0.2±0.02	H / N / P

General CM03 Series Size (JIS Code) : 0201(0603) # Packaging Code (Packaging quantity) : H(15,000pcs.)*10,000pcs.) / N(50,000pcs.) / Q(30,000pcs.) / W(150,000pcs.)

Dielectric code	Capacitance	□:Tolerance	Voltage [V]	Part Number	Tanδ [%]	Dimension			# Packaging Code (quantity)				
						L[mm]	W[mm]	T[mm]					
X5R	3300pF	K:±10% / M:±20%	25	CM03X5R332□25A#	5.0	0.6±0.03	0.3±0.03	0.3±0.03	H / N / Q / W				
	4700pF			CM03X5R472□25A#	5.0	0.6±0.03	0.3±0.03	0.3±0.03	H / N / Q / W				
	6800pF			CM03X5R682□25A#	5.0	0.6±0.03	0.3±0.03	0.3±0.03	H / N / Q / W				
	10000pF			CM03X5R103□25A#	5.0	0.6±0.03	0.3±0.03	0.3±0.03	H / N / Q / W				
	22000pF			CM03X5R223□10A#	10.0	0.6±0.03	0.3±0.03	0.3±0.03	H / N / Q / W				
	33000pF			CM03X5R333□10A#	10.0	0.6±0.03	0.3±0.03	0.3±0.03	H / N / Q / W				
	47000pF	K:±10% / M:±20%	10	CM03X5R473□10A#	10.0	0.6±0.03	0.3±0.03	0.3±0.03	H / N / Q / W				
	68000pF			CM03X5R683□10A#	10.0	0.6±0.03	0.3±0.03	0.3±0.03	H / N / Q / W				
	0.10µF			M:±20%	16	CM03X5R104□10A#	10.0	0.6±0.03	0.3±0.03	0.3±0.03	H / N / Q / W		
	0.22µF					CM03X5R224□10A#	10.0	0.6±0.03	0.3±0.03	0.3±0.03	H / N / Q / W		
	0.47µF					CM03X5R474□10A#	12.5	0.6±0.03	0.3±0.03	0.3±0.03	H / N / Q / W		
	1.0µF					K:±10% / M:±20%	6.3	CM03X5R105M16A#	20.0	0.6±0.09	0.3±0.09	0.3±0.09	H / N
								CM03X5R105M10A#	20.0	0.6±0.09	0.3±0.09	0.3±0.09	H / N
				M:±20%	10	CM03X5R105□06A#	12.5	0.6±0.05	0.3±0.05	0.3±0.05	H / N / Q / W		
	2.2µF					K:±10% / M:±20%	6.3	CM03X5R225M10A#	15.0	0.6±0.09	0.3±0.09	0.3±0.09	H / N
	4.7µF			M:±20%	6.3			CM03X5R225M06A#	12.5	0.6±0.05	0.3±0.05	0.3±0.05	H / N / Q / W
		CM03X5R475M06AH055	15.0					0.6±0.09	0.3±0.09	0.5±0.05	H(*)		
		M:±20%	4	CM03X5R475M04A#	12.5	0.6±0.09	0.3±0.09	0.3±0.09	H / N				
	X6S			1.0µF	M:±20%	CM03X6S105M06A#039	20.0	0.6±0.09	0.3±0.09	0.3±0.09	H / N		
		CM03X6S105M04A#039	20.0			0.6±0.09	0.3±0.09	0.3±0.09	H / N				
	X6T	2.2µF	M:±20%	2.5	CM03X6T225M02A#	12.5	0.6±0.09	0.3±0.09	0.3±0.09	H / N			
					X7R	3300pF	K:±10% / M:±20%	10	CM03X7R332□10A#	5.0	0.6±0.03	0.3±0.03	0.3±0.03
4700pF	CM03X7R472□10A#	5.0	0.6±0.03	0.3±0.03					0.3±0.03	H / N / Q / W			
6800pF	CM03X7R682□10A#	5.0	0.6±0.03	0.3±0.03					0.3±0.03	H / N / Q / W			
10000pF	CM03X7R103□10A#	5.0	0.6±0.03	0.3±0.03					0.3±0.03	H / N / Q / W			

General CM05 Series Size (JIS Code) : 0402(1005) # Packaging Code (Packaging quantity) : H(10,000pcs.) / N(50,000pcs.)*40,000pcs.)*30,000pcs.) / Q(20,000pcs.) / W(100,000pcs.)

Dielectric code	Capacitance	□:Tolerance	Voltage [V]	Part Number	Tanδ [%]	Dimension			# Packaging Code (quantity)	
						L[mm]	W[mm]	T[mm]		
X5R	0.10µF	K:±10% / M:±20%	25	CM05X5R104□25A#	5.0	1.0±0.05	0.5±0.05	0.5±0.05	H / N / Q / W	
	0.22µF			CM05X5R224□16A#	12.5	1.0±0.05	0.5±0.05	0.5±0.05	H / N / Q / W	
	0.47µF			CM05X5R474□10A#	12.5	1.0±0.05	0.5±0.05	0.5±0.05	H / N / Q / W	
	1.0µF	K:±10% / M:±20%	10	CM05X5R105□35A#	10.0	1.0±0.05	0.5±0.05	0.5±0.05	H / N / Q / W	
				25	CM05X5R105□25A#	10.0	1.0±0.05	0.5±0.05	0.5±0.05	H / N / Q / W
				16	CM05X5R105□16A#	10.0	1.0±0.05	0.5±0.05	0.5±0.05	H / N / Q / W
				10	CM05X5R105□10A#	10.0	1.0±0.05	0.5±0.05	0.5±0.05	H / N / Q / W
				25	CM05X5R225M25A#	12.5	1.0±0.20	0.5±0.20	0.5±0.20	H / N(*)
				16	CM05X5R225□16A#	12.5	1.0±0.20	0.5±0.20	0.55 max.	H
	2.2µF	K:±10% / M:±20%	16	CM05X5R225□06A#	12.5	1.0±0.05	0.5±0.05	0.5±0.05	H / N / Q / W	
				10	CM05X5R225□10A#	12.5	1.0±0.05	0.5±0.05	0.5±0.05	H / N / Q / W
				25	CM05X5R475M25A#	12.5	1.0±0.20	0.5±0.20	0.5±0.20	H / N(*)
				16	CM05X5R475□16A#	12.5	1.0±0.20	0.5±0.20	0.5±0.20	H / N(*)
	4.7µF	K:±10% / M:±20%	10	CM05X5R475□10A#	12.5	1.0±0.20	0.5±0.20	0.5±0.20	H / N(*)	
				6.3	CM05X5R106M06A#	12.5	1.0±0.20	0.5±0.20	0.5±0.20	H / N(*)
	10µF	M:±20%	6.3	CM05X5R156M06A#	12.5	1.0±0.15	0.5±0.15	0.5±0.15	H / N(*)	
				4	CM05X5R156M04A#	12.5	1.0±0.15	0.5±0.15	0.5±0.15	H / N(*)
	15µF	M:±20%	6.3	CM05X5R226M06A#080	12.5	1.0±0.20	0.5±0.20	0.80 max.	H / N(**)	
				4	CM05X5R226M04A#	12.5	1.0±0.20	0.5±0.20	0.5±0.20	H / N(*)
	22µF	M:±20%	6.3	CM05X5R226M06A#080	12.5	1.0±0.20	0.5±0.20	0.80 max.	H / N(**)	
				4	CM05X5R226M04A#	12.5	1.0±0.20	0.5±0.20	0.5±0.20	H / N(*)
	X7R	0.10µF	K:±10% / M:±20%	25	CM05X7R104□25A#	12.5	1.0±0.05	0.5±0.05	0.5±0.05	H / N / Q / W
6.3					CM05X7S105□06A#	12.5	1.0±0.05	0.5±0.05	0.5±0.05	H / N / Q / W
X7S	1.0µF	K:±10% / M:±20%	4	CM05X7S105□04A#	12.5	1.0±0.05	0.5±0.05	0.5±0.05	H / N / Q / W	
				4	CM05X7S225M04A#065	5.0	1.0±0.15	0.5±0.15	0.5±0.15	H / N(*)



Part Number List



General CM105 Series Size (JIS Code) : 0603(1608) # Packaging Code (Packaging quantity) : T(4,000pcs.) / L(10,000pcs.)

Dielectric code	Capacitance	□:Tolerance	Voltage [V]	Part Number	Tanδ [%]	Dimension			# Packaging Code (quantity)
						L[mm]	W[mm]	T[mm]	
X5R	1.0μF	K:±10% / M:±20%	25	CM105X5R105□25A#	12.5	1.6±0.15	0.8±0.15	0.8±0.15	T / L
	2.2μF	K:±10% / M:±20%	16	CM105X5R225□16A#	12.5	1.6±0.10	0.8±0.10	0.8±0.10	T / L
	4.7μF	K:±10% / M:±20%	35	CM105X5R475□35A#	12.5	1.6±0.20	0.8±0.20	0.8±0.20	T / L
			25	CM105X5R475□25A#	12.5	1.6±0.20	0.8±0.20	0.8±0.20	T / L
			10	CM105X5R475□10A#	12.5	1.6±0.15	0.8±0.15	0.8±0.15	T / L
			35	CM105X5R106M35A#	15.0	1.6±0.20	0.8±0.20	0.8±0.20	T / L
	10μF	M:±20%	25	CM105X5R106□25A#	15.0	1.6±0.20	0.8±0.20	0.8±0.20	T / L
		K:±10% / M:±20%	16	CM105X5R226M16A#	12.5	1.6±0.20	0.8±0.20	0.8±0.20	T / L
	22μF	M:±20%	10	CM105X5R226M10A#	12.5	1.6±0.20	0.8±0.20	0.8±0.20	T / L
			10	CM105X6S106□10A#	15.0	1.6±0.20	0.8±0.20	0.8±0.20	T / L
X6S	10μF	K:±10% / M:±20%	10	CM105X6S226M06A#	12.5	1.6±0.20	0.8±0.20	0.8±0.20	T / L
	22μF	M:±20%	6.3	CM105X6S226M06A#	12.5	1.6±0.20	0.8±0.20	0.8±0.20	T / L
			4	CM105X6S226M04A#	12.5	1.6±0.20	0.8±0.20	0.8±0.20	T / L
X7R	1.0μF	K:±10% / M:±20%	25	CM105X7R105□25A#	5.0	1.6±0.10	0.8±0.10	0.8±0.10	T / L
			16	CM105X7R105□16A#	12.5	1.6±0.10	0.8±0.10	0.8±0.10	T / L
			10	CM105X7R105□10A#	12.5	1.6±0.10	0.8±0.10	0.8±0.10	T / L
			6.3	CM105X7R225□06A#	12.5	1.6±0.15	0.8±0.15	0.8±0.15	T / L
X7T	4.7μF	K:±10% / M:±20%	10	CM105X7T475□10A#	12.5	1.6±0.20	0.8±0.20	0.8±0.20	T / L
	10μF	M:±20%	6.3	CM105X7T106M06A#	15.0	1.6±0.20	0.8±0.20	0.8±0.20	T / L

General CM21 Series Size (JIS Code) : 0805(2012) # Packaging Code (Packaging quantity) : T(3,000pcs.) / L(10,000pcs.)

Dielectric code	Capacitance	□:Tolerance	Voltage [V]	Part Number	Tanδ [%]	Dimension			# Packaging Code (quantity)
						L[mm]	W[mm]	T[mm]	
X5R	1.0μF	K:±10% / M:±20%	50	CM21X5R105□50A#	12.5	2.0±0.10	1.25±0.10	1.25±0.10	T / L
	2.2μF	K:±10% / M:±20%	25	CM21X5R225□25A#	12.5	2.0±0.20	1.25±0.20	1.25±0.20	T / L
	4.7μF	K:±10% / M:±20%	25	CM21X5R475□25A#	12.5	2.0±0.20	1.25±0.20	1.25±0.20	T / L
	10μF	K:±10% / M:±20%	16	CM21X5R106□16A#	12.5	2.0±0.20	1.25±0.20	1.25±0.20	T / L
			25	CM21X5R226M25A#	12.5	2.0±0.20	1.25±0.20	1.25±0.20	T / L
	22μF	M:±20%	10	CM21X5R226M10A#	12.5	2.0±0.20	1.25±0.20	1.25±0.20	T / L
			6.3	CM21X5R476M06A#	10.0	2.0±0.20	1.25±0.20	1.25±0.20	T / L
	47μF	M:±20%	4	CM21X5R107M04A#	12.5	2.0±0.20	1.25±0.20	1.25±0.20	T / L
100μF	M:±20%	4	CM21X6S226M16A#	12.5	2.0±0.20	1.25±0.20	1.25±0.20	T / L	
X6S	22μF	M:±20%	16	CM21X6S226M16A#	12.5	2.0±0.20	1.25±0.20	1.25±0.20	T / L
			10	CM21X6S226M10A#	12.5	2.0±0.20	1.25±0.20	1.25±0.20	T / L
			6.3	CM21X6S226M06A#	12.5	2.0±0.20	1.25±0.20	1.25±0.20	T / L
	47μF	M:±20%	4	CM21X6S476M04A#	10.0	2.0±0.20	1.25±0.20	1.25±0.20	T / L
	100μF	M:±20%	4	CM21X6S107M04A#	12.5	2.0±0.20	1.25±0.20	1.25±0.20	T / L
X7R	1.0μF	K:±10% / M:±20%	50	CM21X7R105□50A#	5.0	2.0±0.20	1.25±0.20	1.25±0.20	T / L
	2.2μF	K:±10% / M:±20%	25	CM21X7R105□25A#	12.5	2.0±0.10	1.25±0.10	1.25±0.10	T / L
			25	CM21X7R225□25A#	12.5	2.0±0.20	1.25±0.20	1.25±0.20	T / L
	4.7μF	K:±10% / M:±20%	16	CM21X7R475□16A#	12.5	2.0±0.20	1.25±0.20	1.25±0.20	T / L
	10μF	K:±10% / M:±20%	6.3	CM21X7R106□06A#	12.5	2.0±0.20	1.25±0.20	1.25±0.20	T / L
X7S	1.0μF	K:±10% / M:±20%	100	CM21X7S105□100A#	5.0	2.0±0.20	1.25±0.20	1.25±0.20	T / L
X7T	22μF	M:±20%	6.3	CM21X7T226M06A#	12.5	2.0±0.20	1.25±0.20	1.25±0.20	T / L

General CM316 Series Size (JIS Code) : 1206(3216) # Packaging Code (Packaging quantity) : T(2,500pcs.)(*2,000pcs.) / L(5,000pcs.)

Dielectric code	Capacitance	□:Tolerance	Voltage [V]	Part Number	Tanδ [%]	Dimension			# Packaging Code (quantity)
						L[mm]	W[mm]	T[mm]	
X5R	2.2μF	K:±10% / M:±20%	100	CM316X5R225□100A#	5.0	3.2±0.20	1.6±0.20	1.6±0.20	T / L
			25	CM316X5R225□25A#	5.0	3.2±0.20	1.6±0.15	1.6±0.15	T / L
	4.7μF	K:±10% / M:±20%	50	CM316X5R475□50A#	5.0	3.2±0.20	1.6±0.20	1.6±0.20	T / L
	10μF	K:±10% / M:±20%	25	CM316X5R106□25A#	12.5	3.2±0.20	1.6±0.20	1.6±0.20	T / L
	22μF	K:±10% / M:±20%	16	CM316X5R226□16A#	12.5	3.2±0.20	1.6±0.20	1.6±0.20	T / L
X7R	4.7μF	K:±10% / M:±20%	50	CM316X7R475□50A#	5.0	3.2±0.20	1.6±0.20	1.6±0.20	T / L
			25	CM316X7R106□25A#	5.0	3.2±0.20	1.6±0.20	1.6±0.20	T / L
	10μF	K:±10% / M:±20%	16	CM316X7R106□16A#	12.5	3.2±0.20	1.6±0.20	1.6±0.20	T / L
			10	CM316X7R226□10A#	7.5	3.2±0.20	1.6±0.20	1.6±0.20	T / L
X7S	2.2μF	K:±10% / M:±20%	100	CM316X7S225□100A#	5.0	3.2±0.20	1.6±0.20	1.6±0.20	T / L
	4.7μF	K:±10% / M:±20%	100	CM316X7S475□100AT	5.0	3.2±0.30	1.6±0.30	1.6±0.30	T(*)
	22μF	K:±10% / M:±20%	10	CM316X7S226□10A#	7.5	3.2±0.20	1.6±0.20	1.6±0.20	T / L

General CM32 Series Size (JIS Code) : 1210(3225) # Packaging Code (Packaging quantity) : T(1,000pcs.) / L(4,000pcs.)

Dielectric code	Capacitance	□:Tolerance	Voltage [V]	Part Number	Tanδ [%]	Dimension			# Packaging Code (quantity)
						L[mm]	W[mm]	T[mm]	
X5R	10μF	K:±10% / M:±20%	50	CM32X5R106□50A#	5.0	3.2±0.30	2.5±0.20	2.5±0.20	T / L
			25	CM32X5R106□25A#	12.5	3.2±0.30	2.5±0.20	2.5±0.20	T / L
			16	CM32X5R106□16A#	5.0	3.2±0.30	2.5±0.20	2.5±0.20	T / L
			25	CM32X5R226□25A#	12.5	3.2±0.30	2.5±0.20	2.5±0.20	T / L
X7R	10μF	K:±10% / M:±20%	50	CM32X7R106□50A#	5.0	3.2±0.30	2.5±0.20	2.5±0.20	T / L
			25	CM32X7R106□25A#	12.5	3.2±0.30	2.5±0.20	2.5±0.20	T / L
			16	CM32X7R226□16A#	12.5	3.2±0.30	2.5±0.20	2.5±0.20	T / L



1. Specifications described in this catalog are for references. Products specifications shall be based on written documents agreed by each party.
2. Contents in this catalog are subject to change without notice. It is recommended to confirm the latest information at the time of usage. Also, Kyocera Electronic Components Catalog is revised once a year. We may not be able to accept requests based on old catalogs.
3. Products in this catalog are intended to be used in general electronic equipment such as office equipment, audio and visual equipment, communication equipment, measurement instrument and home appliances. It is absolutely recommended to consult with our sales representatives in advance upon planning to use our products in applications which require extremely high quality and reliability such as aircraft and aerospace equipment, traffic systems, safety systems, power plant and medical equipment including life maintenance systems.
4. Even though we strive for improvements of quality and reliability of products, it is requested to design with enough safety margin in equipment or systems in order not to threaten human lives directly or damage human bodies or properties by an accidental result of products.
5. It is requested to design based on guaranteed specifications for such as maximum ratings, operating voltage and operating temperature. It is not the scope of our guarantee for unsatisfactory results due to misuse or inadequate usage of products in the catalog.
6. Operation summaries and circuit examples in this catalog are intended to explain typical operation and usage of the product. It is recommended to perform circuit and assembly design considering surrounding conditions upon using products in this catalog.
7. Technical information described in this catalog is meant to explain typical operations and applications of products, and it is not intended to guarantee or license intellectual properties or other industrial rights of the third party or Kyocera.
8. Trademarks, logos and brand names used in this catalog are owned by Kyocera or the corresponding third party.
9. Certain products in this catalog are subject to the Foreign Exchange and Foreign Trade Control Act of Japan, and require the license from Japanese Government upon exporting the restricted products and technical information under the law.
Besides, it is requested not to use products and technical information in the catalog for the development and/or manufacture of weapons of mass destruction or other conventional weapons, nor to provide them to any third party with the possibility of having such purposes.
10. It is prohibited to reprint and reproduce a part or whole of this catalog without permission.
11. Contents described herein are as of October 2021.