

# 74AVC2T245

## 2-bit dual supply translating transceiver with configurable voltage translation; 3-state

Rev. 2 — 6 April 2017

Product data sheet

## 1 General description

The 74AVC2T245 is a 2-bit, dual supply transceiver that enables bidirectional level translation. The device can be used as two 1-bit transceivers or as a 2-bit transceiver. It features two 2-bit input-output ports (An and Bn) and direction control inputs (DIRn), an output enable input ( $\overline{OE}$ ) and dual supply pins ( $V_{CC(A)}$  and  $V_{CC(B)}$ ). Both  $V_{CC(A)}$  and  $V_{CC(B)}$  can be supplied at any voltage between 0.8 V and 3.6 V making the device suitable for translating between any of the low voltage nodes (0.8 V, 1.2 V, 1.5 V, 1.8 V, 2.5 V and 3.3 V). Pins An,  $\overline{OE}$  and DIRn are referenced to  $V_{CC(A)}$  and pins Bn are referenced to  $V_{CC(B)}$ . A HIGH on DIRn allows transmission from An to Bn and a LOW on DIRn allows transmission from Bn to An. The output enable input ( $\overline{OE}$ ) can be used to disable the outputs so the buses are effectively isolated.

The device is fully specified for partial power-down applications using  $I_{OFF}$ . The  $I_{OFF}$  circuitry disables the output, preventing any damaging backflow current through the device when it is powered down. In suspend mode when either  $V_{CC(A)}$  or  $V_{CC(B)}$  are at GND level, both An and Bn are in the high-impedance OFF-state.

## 2 Features and benefits

- Wide supply voltage range:
  - $V_{CC(A)}$ : 0.8 V to 3.6 V
  - $V_{CC(B)}$ : 0.8 V to 3.6 V
- Complies with JEDEC standards:
  - JESD8-12 (0.8 V to 1.3 V)
  - JESD8-11 (0.9 V to 1.65 V)
  - JESD8-7 (1.2 V to 1.95 V)
  - JESD8-5 (1.8 V to 2.7 V)
  - JESD8-B (2.7 V to 3.6 V)
- ESD protection:
  - HBM JESD22-A114E Class 3B exceeds 8000 V
  - CDM JESD22-C101C exceeds 1000 V
- Maximum data rates:
  - 380 Mbit/s ( $\geq$  1.8 V to 3.3 V translation)
  - 200 Mbit/s ( $\geq$  1.1 V to 3.3 V translation)
  - 200 Mbit/s ( $\geq$  1.1 V to 2.5 V translation)
  - 200 Mbit/s ( $\geq$  1.1 V to 1.8 V translation)
  - 150 Mbit/s ( $\geq$  1.1 V to 1.5 V translation)
  - 100 Mbit/s ( $\geq$  1.1 V to 1.2 V translation)
- Suspend mode
- Latch-up performance exceeds 100 mA per JESD 78 Class II
- Inputs accept voltages up to 3.6 V

- I<sub>OFF</sub> circuitry provides partial Power-down mode operation
- Specified from -40 °C to +85 °C and -40 °C to +125 °C

### 3 Ordering information

Table 1. Ordering information

Type number	Package			Version
	Temperature range	Name	Description	
74AVC2T245GU	-40 °C to +125 °C	XQFN10	plastic, extremely thin quad flat package; no leads; 10 terminals; body 1.40 x 1.80 x 0.50 mm	SOT1160-1

### 4 Marking

Table 2. Marking codes

Type number	Marking code
74AVC2T245GU	B3

### 5 Functional diagram

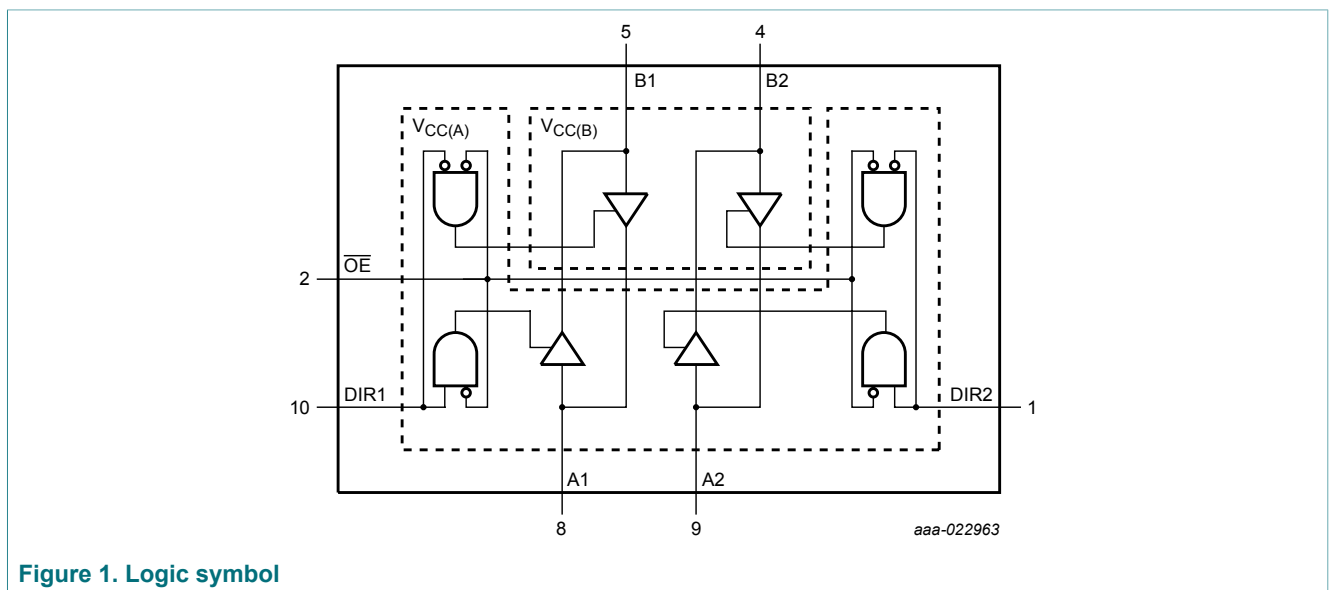

Figure 1. Logic symbol

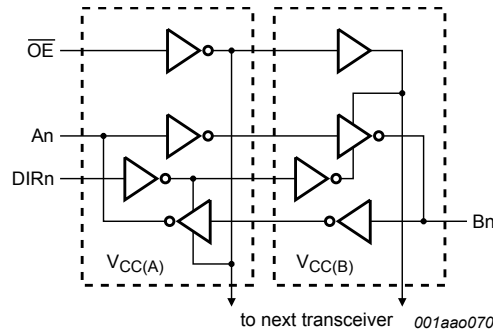

Figure 2. Logic diagram (one 1-bit transceiver)

## 6 Pinning information

### 6.1 Pinning

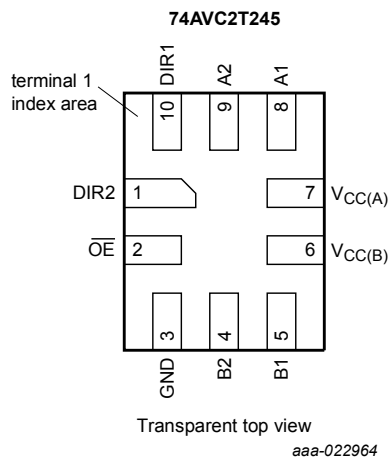

Figure 3. Pin configuration SOT1160-1 (XQFN10)

### 6.2 Pin description

Table 3. Pin description

Symbol	Pin	Description
DIR1, DIR2	10, 1	direction control
$\overline{OE}$	2	output enable input (active LOW)
$V_{CC(B)}$	6	supply voltage B (Bn inputs are referenced to $V_{CC(B)}$ )
$V_{CC(A)}$	7	supply voltage A (An, $\overline{OE}$ and DIRn inputs are referenced to $V_{CC(A)}$ )
A1, A2	8, 9	data input or output
B1, B2	5, 4	data input or output
GND	3	ground (0 V)

## 7 Functional description

Table 4. Function table <sup>[1]</sup>

Supply voltage	Input		Input/output	
$V_{CC(A)}$ , $V_{CC(B)}$	$\overline{OE}$ <sup>[2]</sup>	DIRn <sup>[2]</sup>	An <sup>[2]</sup>	Bn <sup>[2]</sup>
0.8 V to 3.6 V	L	L	An = Bn	input
0.8 V to 3.6 V	L	H	input	Bn = An
0.8 V to 3.6 V	H	X	Z	Z
GND <sup>[3]</sup>	X	X	Z	Z

[1] H = HIGH voltage level; L = LOW voltage level; X = don't care; Z = high-impedance OFF-state.

[2] The An, DIRn and OE input circuit is referenced to  $V_{CC(A)}$ ; The Bn input circuit is referenced to  $V_{CC(B)}$ .

[3] If at least one of  $V_{CC(A)}$  or  $V_{CC(B)}$  is at GND level, the device goes into suspend mode.

## 8 Limiting values

Table 5. Limiting values

In accordance with the Absolute Maximum Rating System (IEC 60134). Voltages are referenced to GND (ground = 0 V).

Symbol	Parameter	Conditions	Min	Max	Unit
$V_{CC(A)}$	supply voltage A		-0.5	+4.6	V
$V_{CC(B)}$	supply voltage B		-0.5	+4.6	V
$I_{IK}$	input clamping current	$V_I < 0$ V	-50	-	mA
$V_I$	input voltage	[1]	-0.5	+4.6	V
$I_{OK}$	output clamping current	$V_O < 0$ V	-50	-	mA
$V_O$	output voltage	Active mode [1] [2] [3]	-0.5	$V_{CCO} + 0.5$	V
		Suspend or 3-state mode [1]	-0.5	+4.6	V
$I_O$	output current	$V_O = 0$ V to $V_{CCO}$ [2]	-	±50	mA
$I_{CC}$	supply current	$I_{CC(A)}$ or $I_{CC(B)}$	-	100	mA
$I_{GND}$	ground current		-100	-	mA
$T_{stg}$	storage temperature		-65	+150	°C
$P_{tot}$	total power dissipation	$T_{amb} = -40$ °C to +125 °C	-	250	mW

[1] The minimum input voltage ratings and output voltage ratings may be exceeded if the input and output current ratings are observed.

[2]  $V_{CCO}$  is the supply voltage associated with the output port.

[3]  $V_{CCO} + 0.5$  V should not exceed 4.6 V.

## 9 Recommended operating conditions

**Table 6. Recommended operating conditions**

Voltages are referenced to GND (ground = 0 V).

Symbol	Parameter	Conditions	Min	Max	Unit
$V_{CC(A)}$	supply voltage A		0.8	3.6	V
$V_{CC(B)}$	supply voltage B		0.8	3.6	V
$V_I$	input voltage		0	3.6	V
$V_O$	output voltage	Active mode <sup>[1]</sup>	0	$V_{CCO}$	V
		Suspend or 3-state mode	0	3.6	V
$T_{amb}$	ambient temperature		-40	+125	°C
$\Delta t/\Delta V$	input transition rise and fall rate	$V_{CCI} = 0.8\text{ V to }3.6\text{ V}$ <sup>[2]</sup>	-	5	ns/V

[1]  $V_{CCO}$  is the supply voltage associated with the output port.

[2]  $V_{CCI}$  is the supply voltage associated with the input port.

## 10 Static characteristics

**Table 7. Typical static characteristics at  $T_{amb} = 25\text{ °C}$  <sup>[1] [2]</sup>**

At recommended operating conditions; voltages are referenced to GND (ground = 0 V).

Symbol	Parameter	Conditions	Min	Typ	Max	Unit
$V_{OH}$	HIGH-level output voltage	$V_I = V_{IH}$ or $V_{IL}$				
		$I_O = -1.5\text{ mA}$ ; $V_{CC(A)} = V_{CC(B)} = 0.8\text{ V}$	-	0.69	-	V
$V_{OL}$	LOW-level output voltage	$V_I = V_{IH}$ or $V_{IL}$				
		$I_O = 1.5\text{ mA}$ ; $V_{CC(A)} = V_{CC(B)} = 0.8\text{ V}$	-	0.07	-	V
$I_I$	input leakage current	DIRn, $\overline{OE}$ input; $V_I = 0\text{ V or }3.6\text{ V}$ ; $V_{CC(A)} = V_{CC(B)} = 0.8\text{ V to }3.6\text{ V}$	-	$\pm 0.025$	$\pm 0.25$	$\mu\text{A}$
$I_{OZ}$	OFF-state output current	A or B port; $V_O = 0\text{ V or }V_{CCO}$ ; $V_{CC(A)} = V_{CC(B)} = 3.6\text{ V}$ <sup>[3]</sup>	-	$\pm 0.5$	$\pm 2.5$	$\mu\text{A}$
		suspend mode A port; $V_O = 0\text{ V or }V_{CCO}$ ; $V_{CC(A)} = 3.6\text{ V}$ ; $V_{CC(B)} = 0\text{ V}$ <sup>[3]</sup>	-	$\pm 0.5$	$\pm 2.5$	$\mu\text{A}$
		suspend mode B port; $V_O = 0\text{ V or }V_{CCO}$ ; $V_{CC(A)} = 0\text{ V}$ ; $V_{CC(B)} = 3.6\text{ V}$ <sup>[3]</sup>	-	$\pm 0.5$	$\pm 2.5$	$\mu\text{A}$
$I_{OFF}$	power-off leakage current	$V_I$ or $V_O = 0\text{ V to }3.6\text{ V}$	-	$\pm 0.1$	$\pm 1$	$\mu\text{A}$
		A port; $V_{CC(A)} = 0\text{ V}$ ; $V_{CC(B)} = 0.8\text{ V to }3.6\text{ V}$	-	$\pm 0.1$	$\pm 1$	$\mu\text{A}$
		B port; $V_{CC(B)} = 0\text{ V}$ ; $V_{CC(A)} = 0.8\text{ V to }3.6\text{ V}$	-	$\pm 0.1$	$\pm 1$	$\mu\text{A}$
$C_I$	input capacitance	DIRn, $\overline{OE}$ input; $V_I = 0\text{ V or }3.3\text{ V}$ ; $V_{CC(A)} = V_{CC(B)} = 3.3\text{ V}$	-	2.0	-	pF
$C_{I/O}$	input/output capacitance	A and B port; $V_O = 3.3\text{ V or }0\text{ V}$ ; $V_{CC(A)} = V_{CC(B)} = 3.3\text{ V}$	-	4.0	-	pF

[1]  $V_{CCO}$  is the supply voltage associated with the output port.

[2]  $V_{CCI}$  is the supply voltage associated with the data input port.

## 2-bit dual supply translating transceiver with configurable voltage translation; 3-state

[3] For I/O ports, the parameter  $I_{OZ}$  includes the input leakage current.

**Table 8. Static characteristics** [1] [2]

At recommended operating conditions; voltages are referenced to GND (ground = 0 V).

Symbol	Parameter	Conditions	-40 °C to +85 °C		-40 °C to +125 °C		Unit
			Min	Max	Min	Max	
$V_{IH}$	HIGH-level input voltage	data input					
		$V_{CCI} = 0.8 \text{ V}$	$0.70V_{CCI}$	-	$0.70V_{CCI}$	-	V
		$V_{CCI} = 1.1 \text{ V to } 1.95 \text{ V}$	$0.65V_{CCI}$	-	$0.65V_{CCI}$	-	V
		$V_{CCI} = 2.3 \text{ V to } 2.7 \text{ V}$	1.6	-	1.6	-	V
		$V_{CCI} = 3.0 \text{ V to } 3.6 \text{ V}$	2	-	2	-	V
		DIRn, $\overline{OE}$ input					
		$V_{CC(A)} = 0.8 \text{ V}$	$0.70V_{CC(A)}$	-	$0.70V_{CC(A)}$	-	V
		$V_{CC(A)} = 1.1 \text{ V to } 1.95 \text{ V}$	$0.65V_{CC(A)}$	-	$0.65V_{CC(A)}$	-	V
$V_{IL}$	LOW-level input voltage	data input					
		$V_{CCI} = 0.8 \text{ V}$	-	$0.30V_{CCI}$	-	$0.30V_{CCI}$	V
		$V_{CCI} = 1.1 \text{ V to } 1.95 \text{ V}$	-	$0.35V_{CCI}$	-	$0.35V_{CCI}$	V
		$V_{CCI} = 2.3 \text{ V to } 2.7 \text{ V}$	-	0.7	-	0.7	V
		$V_{CCI} = 3.0 \text{ V to } 3.6 \text{ V}$	-	0.8	-	0.8	V
		DIRn, $\overline{OE}$ input					
		$V_{CC(A)} = 0.8 \text{ V}$	-	$0.30V_{CC(A)}$	-	$0.30V_{CC(A)}$	V
		$V_{CC(A)} = 1.1 \text{ V to } 1.95 \text{ V}$	-	$0.35V_{CC(A)}$	-	$0.35V_{CC(A)}$	V
$V_{OH}$	HIGH-level output voltage	$V_I = V_{IH}$ or $V_{IL}$					
		$I_O = -100 \mu\text{A}$ ; $V_{CC(A)} = V_{CC(B)} = 0.8 \text{ V to } 3.6 \text{ V}$	$V_{CCO}$ - 0.1	-	$V_{CCO}$ - 0.1	-	V
		$I_O = -3 \text{ mA}$ ; $V_{CC(A)} = V_{CC(B)} = 1.1 \text{ V}$	0.85	-	0.85	-	V
		$I_O = -6 \text{ mA}$ ; $V_{CC(A)} = V_{CC(B)} = 1.4 \text{ V}$	1.05	-	1.05	-	V
		$I_O = -8 \text{ mA}$ ; $V_{CC(A)} = V_{CC(B)} = 1.65 \text{ V}$	1.2	-	1.2	-	V
		$I_O = -9 \text{ mA}$ ; $V_{CC(A)} = V_{CC(B)} = 2.3 \text{ V}$	1.75	-	1.75	-	V
		$I_O = -12 \text{ mA}$ ; $V_{CC(A)} = V_{CC(B)} = 3.0 \text{ V}$	2.3	-	2.3	-	V

## 2-bit dual supply translating transceiver with configurable voltage translation; 3-state

Symbol	Parameter	Conditions	-40 °C to +85 °C		-40 °C to +125 °C		Unit
			Min	Max	Min	Max	
V <sub>OL</sub>	LOW-level output voltage	V <sub>I</sub> = V <sub>IH</sub> or V <sub>IL</sub>					
		I <sub>O</sub> = 100 µA; V <sub>CC(A)</sub> = V <sub>CC(B)</sub> = 0.8 V to 3.6 V	-	0.1	-	0.1	V
		I <sub>O</sub> = 3 mA; V <sub>CC(A)</sub> = V <sub>CC(B)</sub> = 1.1 V	-	0.25	-	0.25	V
		I <sub>O</sub> = 6 mA; V <sub>CC(A)</sub> = V <sub>CC(B)</sub> = 1.4 V	-	0.35	-	0.35	V
		I <sub>O</sub> = 8 mA; V <sub>CC(A)</sub> = V <sub>CC(B)</sub> = 1.65 V	-	0.45	-	0.45	V
		I <sub>O</sub> = 9 mA; V <sub>CC(A)</sub> = V <sub>CC(B)</sub> = 2.3 V	-	0.55	-	0.55	V
		I <sub>O</sub> = 12 mA; V <sub>CC(A)</sub> = V <sub>CC(B)</sub> = 3.0 V	-	0.7	-	0.7	V
I <sub>I</sub>	input leakage current	DIRn, $\overline{OE}$ input; V <sub>I</sub> = 0 V or 3.6 V; V <sub>CC(A)</sub> = V <sub>CC(B)</sub> = 0.8 V to 3.6 V	-	±1	-	±5	µA
I <sub>OZ</sub>	OFF-state output current	A or B port; V <sub>O</sub> = 0 V or V <sub>CCO</sub> ; [3] V <sub>CC(A)</sub> = V <sub>CC(B)</sub> = 3.6 V	-	±5	-	±30	µA
		suspend mode A port; V <sub>O</sub> = 0 V or V <sub>CCO</sub> ; [3] V <sub>CC(A)</sub> = 3.6 V; V <sub>CC(B)</sub> = 0 V	-	±5	-	±30	µA
		suspend mode B port; V <sub>O</sub> = 0 V or V <sub>CCO</sub> ; [3] V <sub>CC(A)</sub> = 0 V; V <sub>CC(B)</sub> = 3.6 V	-	±5	-	±30	µA
I <sub>OFF</sub>	power-off leakage current	A port; V <sub>I</sub> or V <sub>O</sub> = 0 V to 3.6 V; V <sub>CC(A)</sub> = 0 V; V <sub>CC(B)</sub> = 0.8 V to 3.6 V	-	±5	-	±30	µA
		B port; V <sub>I</sub> or V <sub>O</sub> = 0 V to 3.6 V; V <sub>CC(B)</sub> = 0 V; V <sub>CC(A)</sub> = 0.8 V to 3.6 V	-	±5	-	±30	µA
I <sub>CC</sub>	supply current	A port; V <sub>I</sub> = 0 V or V <sub>CCI</sub> ; I <sub>O</sub> = 0 A					
		V <sub>CC(A)</sub> = 0.8 V to 3.6 V; V <sub>CC(B)</sub> = 0.8 V to 3.6 V	-	10	-	55	µA
		V <sub>CC(A)</sub> = 1.1 V to 3.6 V; V <sub>CC(B)</sub> = 1.1 V to 3.6 V	-	8	-	50	µA
		V <sub>CC(A)</sub> = 3.6 V; V <sub>CC(B)</sub> = 0 V	-	8	-	50	µA
		V <sub>CC(A)</sub> = 0 V; V <sub>CC(B)</sub> = 3.6 V	-2	-	-12	-	µA
		B port; V <sub>I</sub> = 0 V or V <sub>CCI</sub> ; I <sub>O</sub> = 0 A					
		V <sub>CC(A)</sub> = 0.8 V to 3.6 V; V <sub>CC(B)</sub> = 0.8 V to 3.6 V	-	10	-	55	µA
		V <sub>CC(A)</sub> = 1.1 V to 3.6 V; V <sub>CC(B)</sub> = 1.1 V to 3.6 V	-	8	-	50	µA
		V <sub>CC(A)</sub> = 3.6 V; V <sub>CC(B)</sub> = 0 V	-2	-	-12	-	µA
		V <sub>CC(A)</sub> = 0 V; V <sub>CC(B)</sub> = 3.6 V	-	8	-	50	µA

## 2-bit dual supply translating transceiver with configurable voltage translation; 3-state

Symbol	Parameter	Conditions	-40 °C to +85 °C		-40 °C to +125 °C		Unit
			Min	Max	Min	Max	
		A plus B port ( $I_{CC(A)} + I_{CC(B)}$ ); $I_O = 0$ A; $V_I = 0$ V or $V_{CCI}$ ; $V_{CC(A)} = 0.8$ V to 3.6 V; $V_{CC(B)} = 0.8$ V to 3.6 V	-	20	-	70	$\mu$ A
		A plus B port ( $I_{CC(A)} + I_{CC(B)}$ ); $I_O = 0$ A; $V_I = 0$ V or $V_{CCI}$ ; $V_{CC(A)} = 1.1$ V to 3.6 V; $V_{CC(B)} = 1.1$ V to 3.6 V	-	16	-	65	$\mu$ A
$\Delta I_{CC}$	additional supply current	$V_I = 3.0$ V; $V_{CC(A)} = V_{CC(B)} = 3.6$ V	-	500	-	650	$\mu$ A

[1]  $V_{CCO}$  is the supply voltage associated with the output port.

[2]  $V_{CCI}$  is the supply voltage associated with the data input port.

[3] For I/O ports, the parameter  $I_{OZ}$  includes the input leakage current.

Table 9. Typical total supply current ( $I_{CC(A)} + I_{CC(B)}$ )

$V_{CC(A)}$	$V_{CC(B)}$							Unit
	0 V	0.8 V	1.2 V	1.5 V	1.8 V	2.5 V	3.3 V	
0 V	0	0.1	0.1	0.1	0.1	0.1	0.1	$\mu$ A
0.8 V	0.1	0.1	0.1	0.1	0.1	0.3	1.6	$\mu$ A
1.2 V	0.1	0.1	0.1	0.1	0.1	0.1	0.8	$\mu$ A
1.5 V	0.1	0.1	0.1	0.1	0.1	0.1	0.4	$\mu$ A
1.8 V	0.1	0.1	0.1	0.1	0.1	0.1	0.2	$\mu$ A
2.5 V	0.1	0.3	0.1	0.1	0.1	0.1	0.1	$\mu$ A
3.3 V	0.1	1.6	0.8	0.4	0.2	0.1	0.1	$\mu$ A



## 11 Dynamic characteristics

**Table 10. Typical power dissipation capacitance at  $V_{CC(A)} = V_{CC(B)}$  and  $T_{amb} = 25\text{ °C}$  [1] [2]**

Voltages are referenced to GND (ground = 0 V).

Symbol	Parameter	Conditions	$V_{CC(A)} = V_{CC(B)}$						Unit
			0.8 V	1.2 V	1.5 V	1.8 V	2.5 V	3.3 V	
C <sub>PD</sub>	power dissipation capacitance	A port: (direction An to Bn); output enabled	0.2	0.2	0.2	0.2	0.3	0.6	pF
		A port: (direction An to Bn); output disabled	0.2	0.2	0.2	0.2	0.3	0.6	pF
		A port: (direction Bn to An); output enabled	9	9	9	10	12	14	pF
		A port: (direction Bn to An); output disabled	0.6	0.7	0.7	0.7	0.8	0.9	pF
		B port: (direction An to Bn); output enabled	9	9	9	10	12	14	pF
		B port: (direction An to Bn); output disabled	0.6	0.7	0.7	0.7	0.8	0.9	pF
		B port: (direction Bn to An); output enabled	0.2	0.2	0.2	0.2	0.3	0.6	pF
		B port: (direction Bn to An); output disabled	0.2	0.2	0.2	0.2	0.3	0.6	pF

[1] C<sub>PD</sub> is used to determine the dynamic power dissipation (P<sub>D</sub> in μW).

$$P_D = C_{PD} \times V_{CC}^2 \times f_i \times N + \sum(C_L \times V_{CC}^2 \times f_o) \text{ where:}$$

f<sub>i</sub> = input frequency in MHz;

f<sub>o</sub> = output frequency in MHz;

C<sub>L</sub> = load capacitance in pF;

V<sub>CC</sub> = supply voltage in V;

N = number of inputs switching;

$\sum(C_L \times V_{CC}^2 \times f_o)$  = sum of the outputs.

[2] f<sub>i</sub> = 10 MHz; V<sub>I</sub> = GND to V<sub>CC</sub>; t<sub>r</sub> = t<sub>f</sub> = 1 ns; C<sub>L</sub> = 0 pF; R<sub>L</sub> = ∞ Ω.

**Table 11. Typical dynamic characteristics at  $V_{CC(A)} = 0.8\text{ V}$  and  $T_{amb} = 25\text{ °C}$  [1]**

Voltages are referenced to GND (ground = 0 V); for test circuit see Figure 6; for waveforms see Figure 4 and Figure 5

Symbol	Parameter	Conditions	$V_{CC(B)}$						Unit
			0.8 V	1.2 V	1.5 V	1.8 V	2.5 V	3.3 V	
t <sub>pd</sub>	propagation delay	An to Bn	17.5	8.0	7.0	6.7	6.6	6.7	ns
		Bn to An	17.6	14.8	14.4	14.2	14.0	13.8	ns
t <sub>dis</sub>	disable time	$\overline{OE}$ to An	17.0	17.0	17.0	17.0	17.0	17.0	ns
		$\overline{OE}$ to Bn	19.7	10.9	9.8	10.0	9.3	9.9	ns
t <sub>en</sub>	enable time	$\overline{OE}$ to An	30.3	30.2	30.2	30.2	30.1	30.1	ns
		$\overline{OE}$ to Bn	34.3	22.7	21.5	21.0	21.1	21.5	ns

[1] t<sub>pd</sub> is the same as t<sub>PLH</sub> and t<sub>PHL</sub>; t<sub>dis</sub> is the same as t<sub>PLZ</sub> and t<sub>PHZ</sub>; t<sub>en</sub> is the same as t<sub>PZL</sub> and t<sub>PZH</sub>.

2-bit dual supply translating transceiver with configurable voltage translation; 3-state

**Table 12. Typical dynamic characteristics at  $V_{CC(B)} = 0.8\text{ V}$  and  $T_{amb} = 25\text{ °C}$  [1]**

*Voltages are referenced to GND (ground = 0 V); for test circuit see Figure 6; for waveforms see Figure 4 and Figure 5*

Symbol	Parameter	Conditions	$V_{CC(A)}$						Unit
			0.8 V	1.2 V	1.5 V	1.8 V	2.5 V	3.3 V	
$t_{pd}$	propagation delay	An to Bn	17.5	14.8	14.3	14.1	13.9	13.8	ns
		Bn to An	17.6	8.0	7.1	6.8	6.6	6.7	ns
$t_{dis}$	disable time	$\overline{OE}$ to An	17.0	5.8	4.1	4.0	2.9	3.4	ns
		$\overline{OE}$ to Bn	19.7	15.6	15.0	14.7	14.4	14.1	ns
$t_{en}$	enable time	$\overline{OE}$ to An	30.3	6.2	4.1	3.1	2.2	1.8	ns
		$\overline{OE}$ to Bn	34.3	18.1	17.2	16.8	16.5	16.3	ns

[1]  $t_{pd}$  is the same as  $t_{PLH}$  and  $t_{PHL}$ ;  $t_{dis}$  is the same as  $t_{PLZ}$  and  $t_{PHZ}$ ;  $t_{en}$  is the same as  $t_{pZL}$  and  $t_{pZH}$ .

**Table 13. Dynamic characteristics for temperature range  $-40\text{ °C}$  to  $+85\text{ °C}$  [1]**

*Voltages are referenced to GND (ground = 0 V); for test circuit see Figure 6; for waveforms see Figure 4 and Figure 5*

Symbol	Parameter	Conditions	$V_{CC(B)}$										Unit
			1.2 V±0.1 V		1.5 V±0.1 V		1.8 V±0.15 V		2.5 V±0.2 V		3.3 V±0.3 V		
			Min	Max	Min	Max	Min	Max	Min	Max	Min	Max	
$V_{CC(A)} = 1.1\text{ V to }1.3\text{ V}$													
$t_{pd}$	propagation delay	An to Bn	1.1	9.2	1.1	6.9	0.9	5.9	0.9	5.3	0.8	5.2	ns
		Bn to An	1.1	9.2	1	8.5	1	8.2	0.9	8.2	0.8	8	ns
$t_{dis}$	disable time	$\overline{OE}$ to An	2.4	10	2.4	10	2.4	10	2.4	10	2.4	10	ns
		$\overline{OE}$ to Bn	2.7	10.8	2.3	8.4	2.5	8	2.1	7	2.6	7.8	ns
$t_{en}$	enable time	$\overline{OE}$ to An	1.5	12.4	1.5	12.4	1.5	12.4	1.5	12.4	1.5	12.4	ns
		$\overline{OE}$ to Bn	1.9	12.6	1.7	9.3	1.6	8	1.5	6.9	1.4	6.7	ns
$V_{CC(A)} = 1.4\text{ V to }1.6\text{ V}$													
$t_{pd}$	propagation delay	An to Bn	1	8.5	1	5.5	0.9	4.7	0.9	3.8	0.8	3.5	ns
		Bn to An	1.1	6.9	1	5.5	1	5.3	0.9	5	0.8	4.8	ns
$t_{dis}$	disable time	$\overline{OE}$ to An	2	6.3	2	6.3	2	6.3	2	6.3	2	6.3	ns
		$\overline{OE}$ to Bn	2.6	9.8	2.2	6.7	2.5	6.5	2	5.4	2.5	6	ns
$t_{en}$	enable time	$\overline{OE}$ to An	1.2	6.8	1.2	6.8	1.2	6.8	1.2	6.8	1.2	6.8	ns
		$\overline{OE}$ to Bn	1.7	11	1.5	6.8	1.4	5.8	1.3	4.8	1.3	4.4	ns
$V_{CC(A)} = 1.65\text{ V to }1.95\text{ V}$													
$t_{pd}$	propagation delay	An to Bn	1	8.2	1	5.3	0.9	4.4	0.8	3.4	0.7	3.2	ns
		Bn to An	0.9	5.9	0.9	4.7	0.9	4.4	0.8	4.1	0.7	3.9	ns
$t_{dis}$	disable time	$\overline{OE}$ to An	2.1	5.9	2.1	5.9	2.1	5.9	2.1	5.9	2.1	5.9	ns
		$\overline{OE}$ to Bn	2.4	9.5	2.1	6.4	2.3	6.2	1.8	5	2.3	5.6	ns
$t_{en}$	enable time	$\overline{OE}$ to An	1.1	5.3	1.1	5.3	1.1	5.3	1.1	5.3	1.1	5.3	ns
		$\overline{OE}$ to Bn	1.6	10.5	1.4	6.3	1.3	5.3	1.2	4.3	1.1	3.9	ns

2-bit dual supply translating transceiver with configurable voltage translation; 3-state

Symbol	Parameter	Conditions	$V_{CC(B)}$										Unit
			1.2 V±0.1 V		1.5 V±0.1 V		1.8 V±0.15 V		2.5 V±0.2 V		3.3 V±0.3 V		
			Min	Max	Min	Max	Min	Max	Min	Max	Min	Max	
$V_{CC(A)} = 2.3 \text{ V to } 2.7 \text{ V}$													
$t_{pd}$	propagation delay	An to Bn	0.9	8.2	0.9	5	0.8	4.1	0.7	3.1	0.6	2.7	ns
		Bn to An	0.9	5.3	0.9	3.8	0.8	3.4	0.7	3.1	0.6	3	ns
$t_{dis}$	disable time	$\overline{OE}$ to An	1.5	4.3	1.5	4.3	1.5	4.3	1.5	4.3	1.5	4.3	ns
		$\overline{OE}$ to Bn	2.3	9	1.9	6	2.2	5.8	1.6	4.6	2.1	5.1	ns
$t_{en}$	enable time	$\overline{OE}$ to An	0.9	3.6	0.9	3.6	0.9	3.6	0.9	3.6	0.9	3.6	ns
		$\overline{OE}$ to Bn	1.3	10	1.3	5.8	1.2	4.8	1.1	3.7	1.1	3.3	ns
$V_{CC(A)} = 3.0 \text{ V to } 3.6 \text{ V}$													
$t_{pd}$	propagation delay	An to Bn	0.8	8	0.8	4.8	0.7	3.9	0.6	3	0.5	2.6	ns
		Bn to An	0.8	5.2	0.8	3.5	0.7	3.2	0.6	2.7	0.5	2.6	ns
$t_{dis}$	disable time	$\overline{OE}$ to An	1.9	4.7	1.9	4.7	1.9	4.7	1.9	4.7	1.9	4.7	ns
		$\overline{OE}$ to Bn	2.2	8.6	1.9	5.8	2	5.6	1.5	4.4	2	5	ns
$t_{en}$	enable time	$\overline{OE}$ to An	0.9	2.9	0.9	2.9	0.9	2.9	0.9	2.9	0.9	2.9	ns
		$\overline{OE}$ to Bn	1.5	9.8	1.4	5.6	1.2	4.6	1.1	3.5	1.1	3.1	ns

[1]  $t_{pd}$  is the same as  $t_{PLH}$  and  $t_{PHL}$ ;  $t_{dis}$  is the same as  $t_{PLZ}$  and  $t_{PHZ}$ ;  $t_{en}$  is the same as  $t_{PZL}$  and  $t_{PZH}$ .

Table 14. Dynamic characteristics for temperature range -40 °C to +125 °C [1]

Voltages are referenced to GND (ground = 0 V); for test circuit see Figure 6; for waveforms see Figure 4 and Figure 5

Symbol	Parameter	Conditions	$V_{CC(B)}$										Unit
			1.2 V±0.1 V		1.5 V±0.1 V		1.8 V±0.15 V		2.5 V±0.2 V		3.3 V±0.3 V		
			Min	Max	Min	Max	Min	Max	Min	Max	Min	Max	
$V_{CC(A)} = 1.1 \text{ V to } 1.3 \text{ V}$													
$t_{pd}$	propagation delay	An to Bn	1.1	9.7	1.1	7.3	0.9	6.3	0.9	5.6	0.8	5.5	ns
		Bn to An	1.1	9.7	1	8.9	1	8.6	0.9	8.6	0.8	8.4	ns
$t_{dis}$	disable time	$\overline{OE}$ to An	2.4	10.5	2.4	10.5	2.4	10.5	2.4	10.5	2.4	10.5	ns
		$\overline{OE}$ to Bn	2.7	11.6	2.3	9.1	2.5	8.6	2.1	7.5	2.6	8.4	ns
$t_{en}$	enable time	$\overline{OE}$ to An	1.5	13	1.5	13	1.5	13	1.5	13	1.5	13	ns
		$\overline{OE}$ to Bn	1.9	13	1.7	9.6	1.6	8.4	1.5	7.2	1.4	7	ns
$V_{CC(A)} = 1.4 \text{ V to } 1.6 \text{ V}$													
$t_{pd}$	propagation delay	An to Bn	1	8.9	1	5.7	0.9	4.9	0.9	4	0.8	3.7	ns
		Bn to An	1.1	7.3	1	5.7	1	5.5	0.9	5.2	0.8	5.1	ns
$t_{dis}$	disable time	$\overline{OE}$ to An	2	6.7	2	6.7	2	6.7	2	6.7	2	6.7	ns
		$\overline{OE}$ to Bn	2.6	10.2	2.2	7.1	2.5	6.9	2	5.7	2.5	6.3	ns
$t_{en}$	enable time	$\overline{OE}$ to An	1.2	7.3	1.2	7.3	1.2	7.3	1.2	7.3	1.2	7.3	ns

Symbol	Parameter	Conditions	$V_{CC(B)}$										Unit
			1.2 V±0.1 V		1.5 V±0.1 V		1.8 V±0.15 V		2.5 V±0.2 V		3.3 V±0.3 V		
			Min	Max	Min	Max	Min	Max	Min	Max	Min	Max	
		$\overline{OE}$ to Bn	1.7	11.4	1.5	7.1	1.4	6.1	1.3	5.1	1.3	4.7	ns
$V_{CC(A)} = 1.65 \text{ V to } 1.95 \text{ V}$													
$t_{pd}$	propagation delay	An to Bn	1	8.6	1	5.5	0.9	4.6	0.8	3.6	0.7	3.4	ns
		Bn to An	0.9	6.3	0.9	4.9	0.9	4.6	0.8	4.3	0.7	4.1	ns
$t_{dis}$	disable time	$\overline{OE}$ to An	2.1	6.2	2.1	6.2	2.1	6.2	2.1	6.2	2.1	6.2	ns
		$\overline{OE}$ to Bn	2.4	10	2.1	6.8	2.3	6.6	1.8	5.3	2.3	5.9	ns
$t_{en}$	enable time	$\overline{OE}$ to An	1.1	5.7	1.1	5.7	1.1	5.7	1.1	5.7	1.1	5.7	ns
		$\overline{OE}$ to Bn	1.6	11	1.4	6.7	1.3	5.7	1.2	4.6	1.1	4.2	ns
$V_{CC(A)} = 2.3 \text{ V to } 2.7 \text{ V}$													
$t_{pd}$	propagation delay	An to Bn	0.9	8.6	0.9	5.2	0.8	4.3	0.7	3.3	0.6	2.9	ns
		Bn to An	0.9	5.6	0.9	4	0.8	3.6	0.7	3.3	0.6	3.2	ns
$t_{dis}$	disable time	$\overline{OE}$ to An	1.5	4.6	1.5	4.6	1.5	4.6	1.5	4.6	1.5	4.6	ns
		$\overline{OE}$ to Bn	2.3	9.5	1.9	6.4	2.2	6.1	1.6	4.9	2.1	5.4	ns
$t_{en}$	enable time	$\overline{OE}$ to An	0.9	3.9	0.9	3.9	0.9	3.9	0.9	3.9	0.9	3.9	ns
		$\overline{OE}$ to Bn	1.3	10.5	1.3	6.2	1.2	5.1	1.1	4	1.1	3.6	ns
$V_{CC(A)} = 3.0 \text{ V to } 3.6 \text{ V}$													
$t_{pd}$	propagation delay	An to Bn	0.8	8.4	0.8	5.1	0.7	4.1	0.6	3.2	0.5	2.7	ns
		Bn to An	0.8	5.5	0.8	3.7	0.7	3.4	0.6	2.9	0.5	2.7	ns
$t_{dis}$	disable time	$\overline{OE}$ to An	1.9	5	1.9	5	1.9	5	1.9	5	1.9	5	ns
		$\overline{OE}$ to Bn	2.2	9	1.9	6.2	2	5.9	1.5	4.7	2	5.2	ns
$t_{en}$	enable time	$\overline{OE}$ to An	0.9	3.1	0.9	3.1	0.9	3.1	0.9	3.1	0.9	3.1	ns
		$\overline{OE}$ to Bn	1.5	10.2	1.4	5.9	1.2	5	1.1	3.7	1.1	3.3	ns

[1]  $t_{pd}$  is the same as  $t_{PLH}$  and  $t_{PHL}$ ;  $t_{dis}$  is the same as  $t_{PLZ}$  and  $t_{PHZ}$ ;  $t_{en}$  is the same as  $t_{PZL}$  and  $t_{PZH}$ .

### 11.1 Waveforms and test circuit

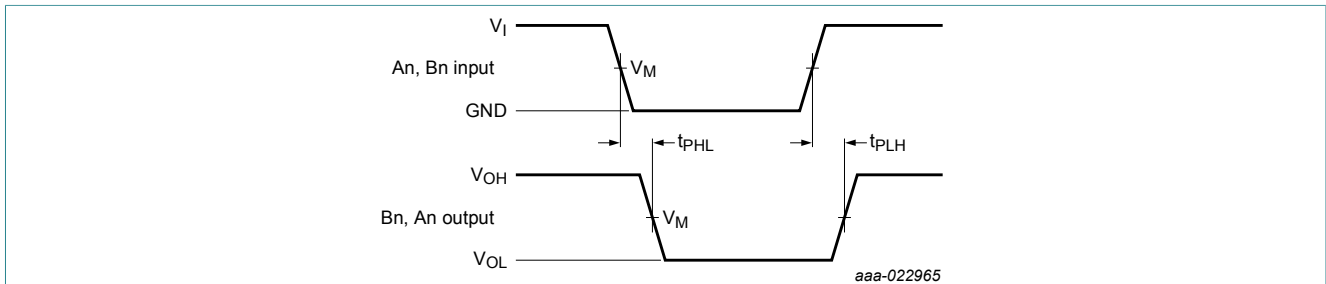

Measurement points are given in [Table 15](#).

$V_{OL}$  and  $V_{OH}$  are typical output voltage levels that occur with the output load.

**Figure 4. The data input (An, Bn) to output (Bn, An) propagation delay times**

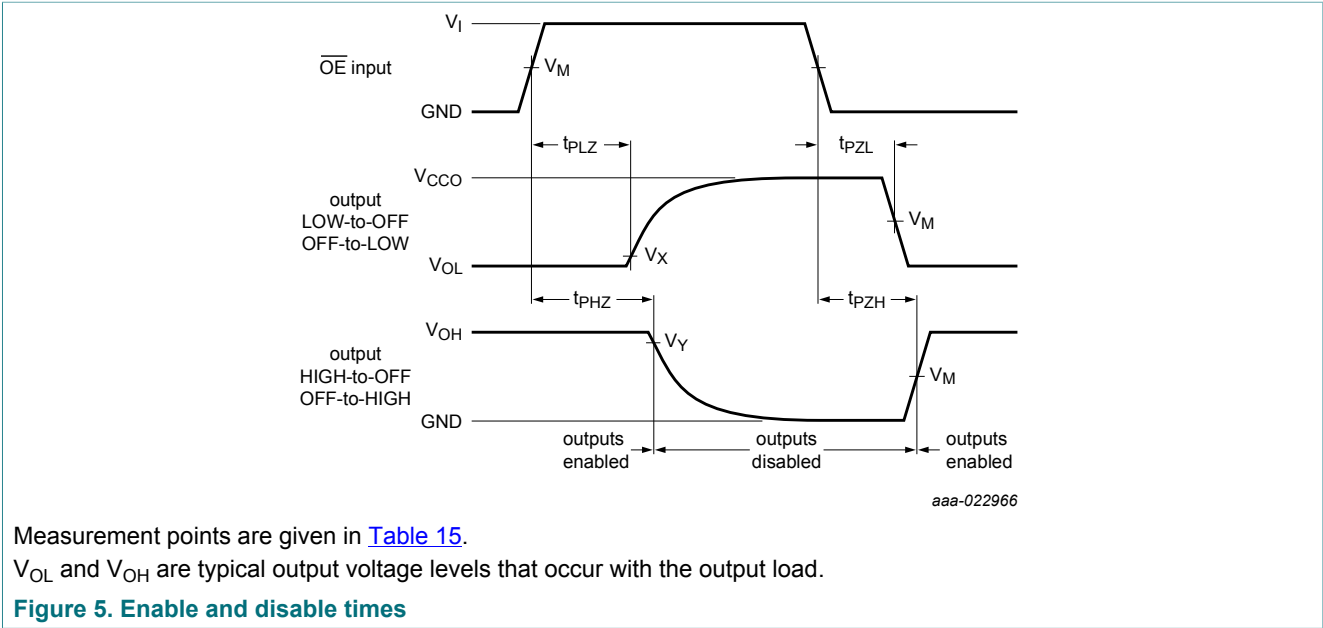

Measurement points are given in [Table 15](#).

$V_{OL}$  and  $V_{OH}$  are typical output voltage levels that occur with the output load.

**Figure 5. Enable and disable times**

**Table 15. Measurement points**

Supply voltage	Input <sup>[1]</sup>	Output <sup>[2]</sup>		
$V_{CC(A)}, V_{CC(B)}$	$V_M$	$V_M$	$V_X$	$V_Y$
0.8 V to 1.6 V	$0.5V_{CCI}$	$0.5V_{CC0}$	$V_{OL} + 0.1 \text{ V}$	$V_{OH} - 0.1 \text{ V}$
1.65 V to 2.7 V	$0.5V_{CCI}$	$0.5V_{CC0}$	$V_{OL} + 0.15 \text{ V}$	$V_{OH} - 0.15 \text{ V}$
3.0 V to 3.6 V	$0.5V_{CCI}$	$0.5V_{CC0}$	$V_{OL} + 0.3 \text{ V}$	$V_{OH} - 0.3 \text{ V}$

[1]  $V_{CCI}$  is the supply voltage associated with the data input port.  
 [2]  $V_{CC0}$  is the supply voltage associated with the output port.

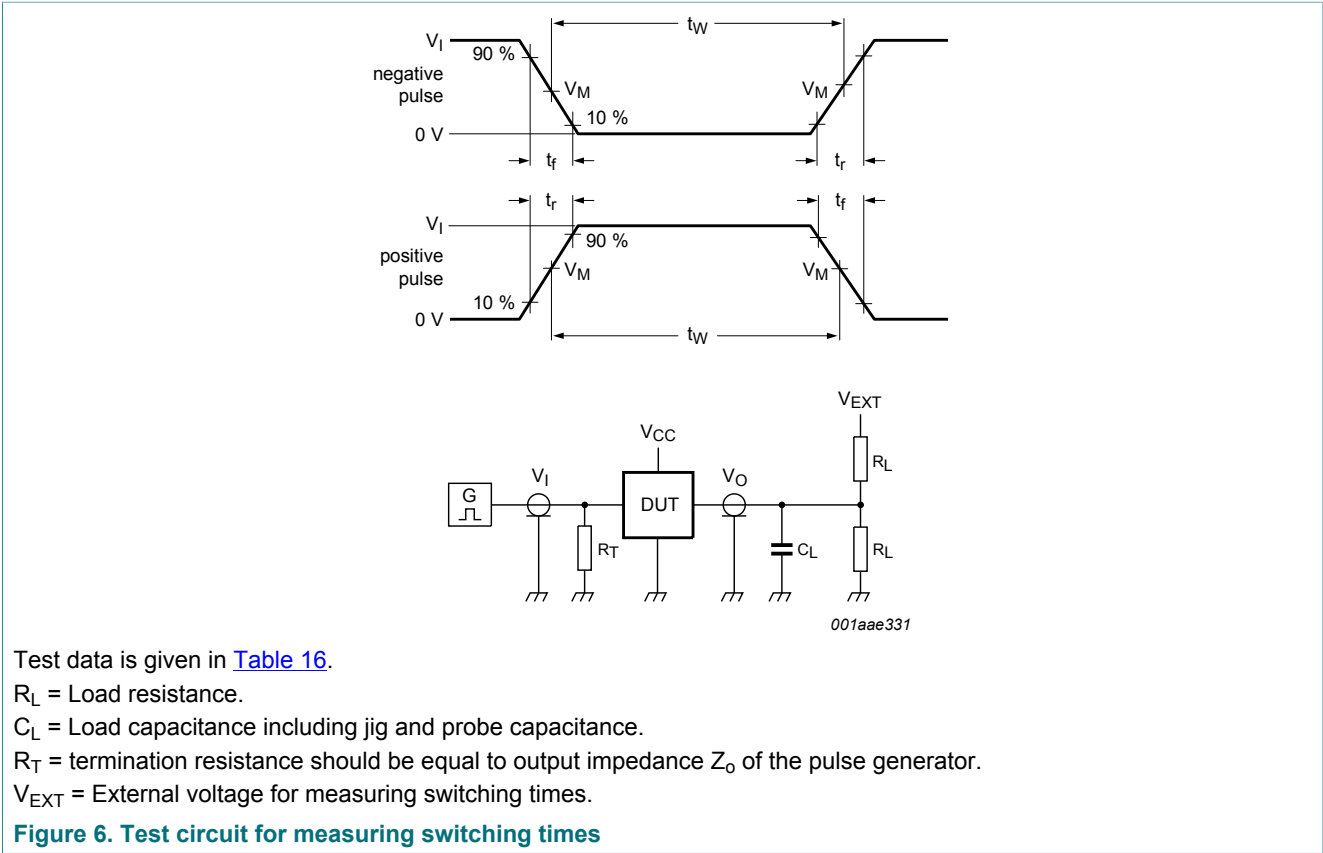

Test data is given in [Table 16](#).

$R_L$  = Load resistance.

$C_L$  = Load capacitance including jig and probe capacitance.

$R_T$  = termination resistance should be equal to output impedance  $Z_o$  of the pulse generator.

$V_{EXT}$  = External voltage for measuring switching times.

**Figure 6. Test circuit for measuring switching times**

**Table 16. Test data**

Supply voltage	Input		Load		$V_{EXT}$		
	$V_{CC(A)}$ , $V_{CC(B)}$	$V_I$ [1]	$\Delta t/\Delta V$ [2]	$C_L$	$R_L$	$t_{PLH}$ , $t_{PHL}$	$t_{PZH}$ , $t_{PHZ}$
0.8 V to 1.6 V	$V_{CCI}$	$\leq 1.0$ ns/V	15 pF	2 k $\Omega$	open	GND	$2V_{CCO}$
1.65 V to 2.7 V	$V_{CCI}$	$\leq 1.0$ ns/V	15 pF	2 k $\Omega$	open	GND	$2V_{CCO}$
3.0 V to 3.6 V	$V_{CCI}$	$\leq 1.0$ ns/V	15 pF	2 k $\Omega$	open	GND	$2V_{CCO}$

[1]  $V_{CCI}$  is the supply voltage associated with the data input port.

[2]  $dV/dt \geq 1.0$  V/ns

[3]  $V_{CCO}$  is the supply voltage associated with the output port.

## 12 Typical propagation delay characteristics

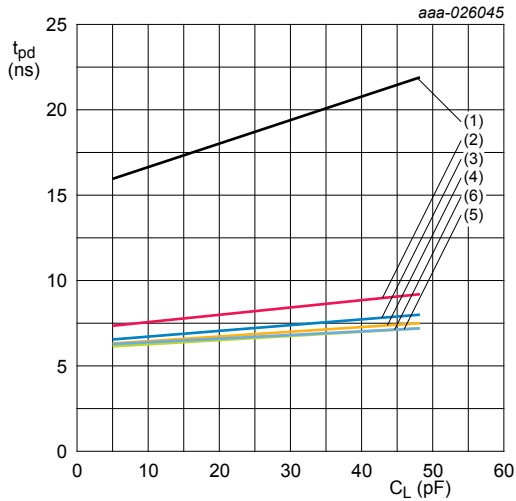

a. Propagation delay (A to B);  $V_{CC(A)} = 0.8$  V

- (1)  $V_{CC(B)} = 0.8$  V
- (2)  $V_{CC(B)} = 1.2$  V
- (3)  $V_{CC(B)} = 1.5$  V
- (4)  $V_{CC(B)} = 1.8$  V
- (5)  $V_{CC(B)} = 2.5$  V
- (6)  $V_{CC(B)} = 3.3$  V

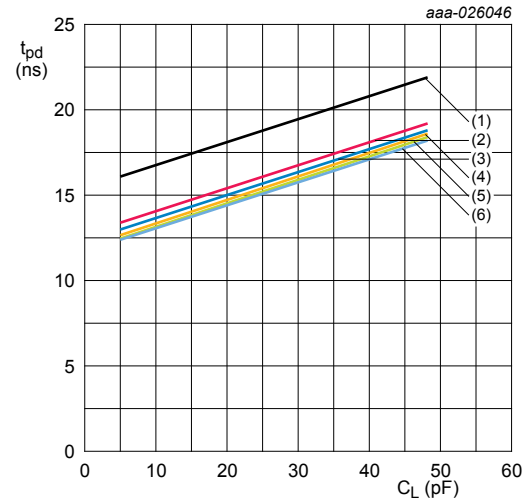

b. Propagation delay (A to B);  $V_{CC(B)} = 0.8$  V

- (1)  $V_{CC(A)} = 0.8$  V
- (2)  $V_{CC(A)} = 1.2$  V
- (3)  $V_{CC(A)} = 1.5$  V
- (4)  $V_{CC(A)} = 1.8$  V
- (5)  $V_{CC(A)} = 2.5$  V
- (6)  $V_{CC(A)} = 3.3$  V

Figure 7. Typical propagation delay versus load capacitance;  $T_{amb} = 25$  °C

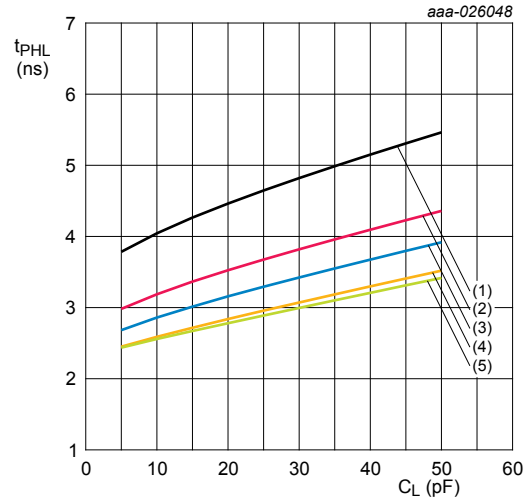
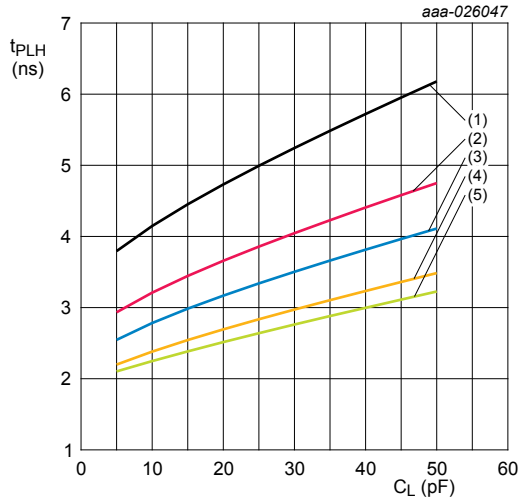

a. LOW to HIGH propagation delay (A to B);  $V_{CC(A)} = 1.2\text{ V}$

b. HIGH to LOW propagation delay (A to B);  $V_{CC(A)} = 1.2\text{ V}$

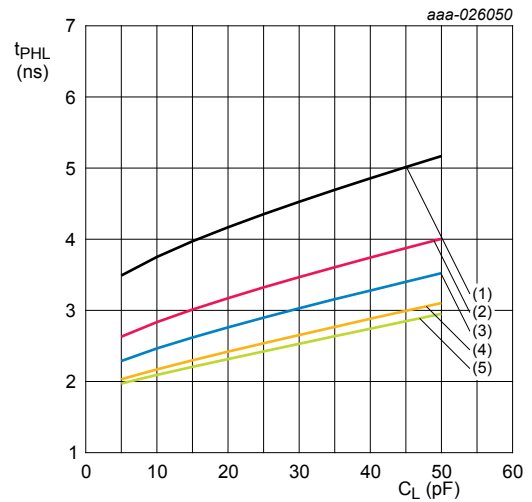
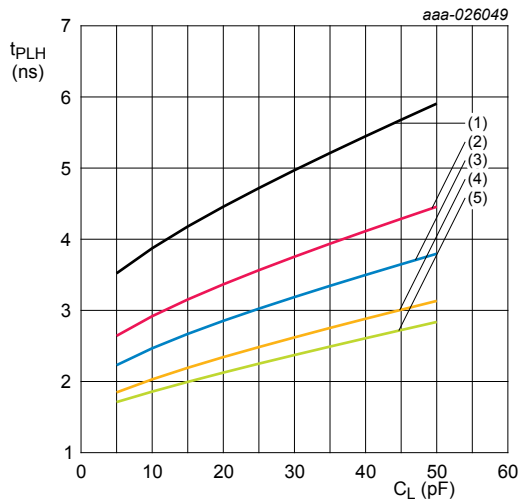

c. LOW to HIGH propagation delay (A to B);  $V_{CC(A)} = 1.5\text{ V}$

d. HIGH to LOW propagation delay (A to B);  $V_{CC(A)} = 1.5\text{ V}$

- (1)  $V_{CC(B)} = 1.2\text{ V}$
- (2)  $V_{CC(B)} = 1.5\text{ V}$
- (3)  $V_{CC(B)} = 1.8\text{ V}$
- (4)  $V_{CC(B)} = 2.5\text{ V}$
- (5)  $V_{CC(B)} = 3.3\text{ V}$

Figure 8. Typical propagation delay versus load capacitance;  $T_{amb} = 25\text{ }^\circ\text{C}$



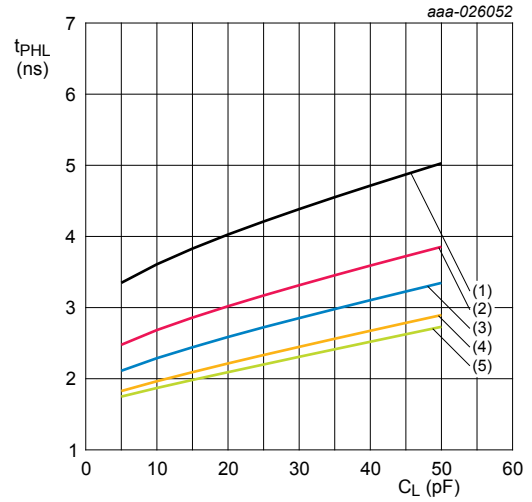
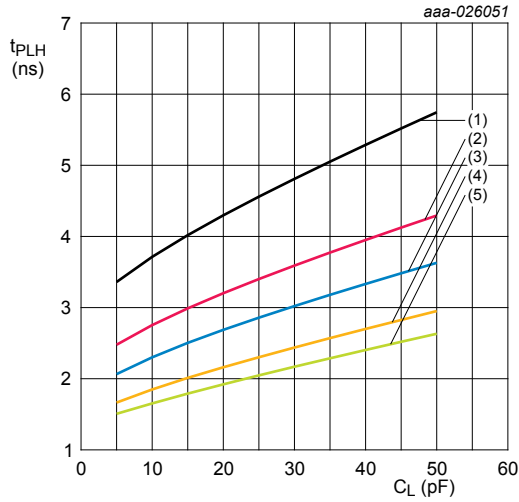

a. LOW to HIGH propagation delay (A to B);  $V_{CC(A)} = 1.8\text{ V}$

b. HIGH to LOW propagation delay (A to B);  $V_{CC(A)} = 1.8\text{ V}$

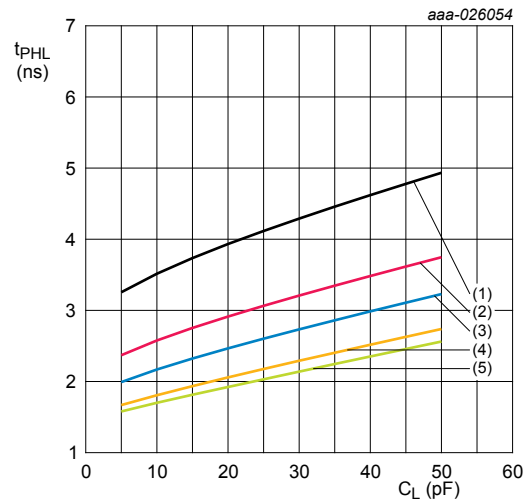
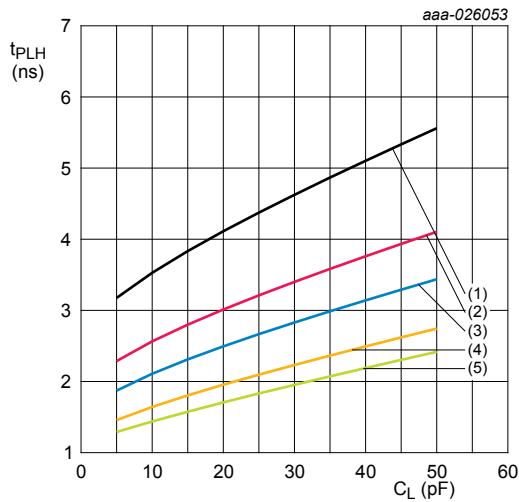

c. LOW to HIGH propagation delay (A to B);  $V_{CC(A)} = 2.5\text{ V}$

d. HIGH to LOW propagation delay (A to B);  $V_{CC(A)} = 2.5\text{ V}$

- (1)  $V_{CC(B)} = 1.2\text{ V}$
- (2)  $V_{CC(B)} = 1.5\text{ V}$
- (3)  $V_{CC(B)} = 1.8\text{ V}$
- (4)  $V_{CC(B)} = 2.5\text{ V}$
- (5)  $V_{CC(B)} = 3.3\text{ V}$

Figure 9. Typical propagation delay versus load capacitance;  $T_{amb} = 25\text{ }^\circ\text{C}$

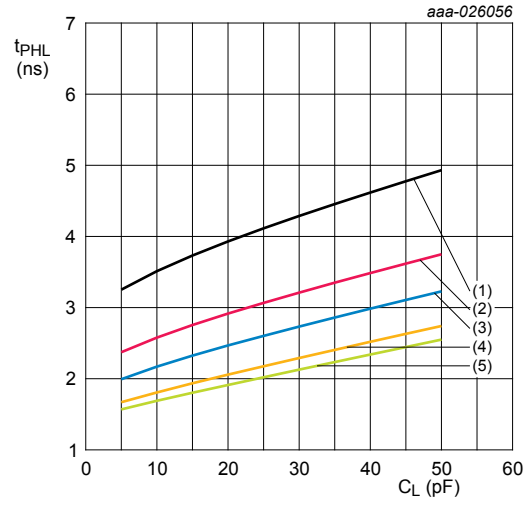
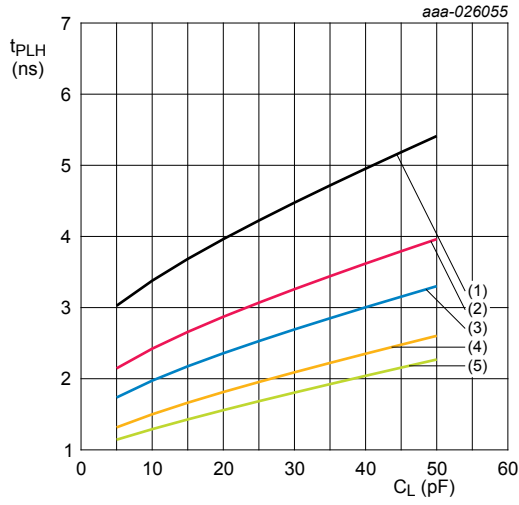

a. LOW to HIGH propagation delay (A to B);  $V_{CC(A)} = 3.3\text{ V}$     b. HIGH to LOW propagation delay (A to B);  $V_{CC(A)} = 3.3\text{ V}$

- (1)  $V_{CC(B)} = 1.2\text{ V}$
- (2)  $V_{CC(B)} = 1.5\text{ V}$
- (3)  $V_{CC(B)} = 1.8\text{ V}$
- (4)  $V_{CC(B)} = 2.5\text{ V}$
- (5)  $V_{CC(B)} = 3.3\text{ V}$

Figure 10. Typical propagation delay versus load capacitance;  $T_{amb} = 25\text{ °C}$

13 Package outline

XQFN10: plastic, extremely thin quad flat package; no leads;  
10 terminals; body 1.40 x 1.80 x 0.50 mm

SOT1160-1

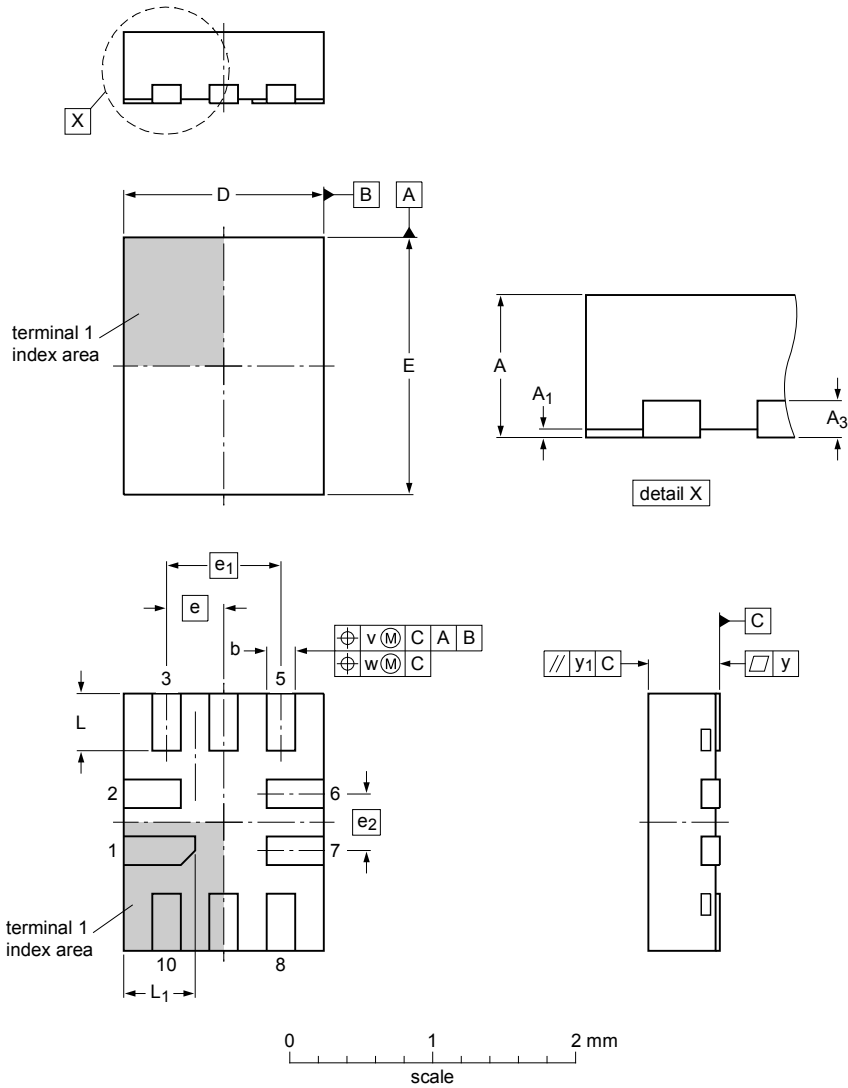

Dimensions

Unit <sup>(1)</sup>	A	A <sub>1</sub>	A <sub>3</sub>	b	D	E	e	e <sub>1</sub>	e <sub>2</sub>	L	L <sub>1</sub>	v	w	y	y <sub>1</sub>
max	0.5	0.05		0.25	1.5	1.9				0.45	0.55				
nom			0.127	0.20	1.4	1.8	0.4	0.8	0.4	0.40	0.50	0.1	0.05	0.05	0.05
min		0.00		0.15	1.3	1.7				0.35	0.45				

Note

1. Plastic or metal protrusions of 0.075 mm maximum per side are not included.

sot1160-1\_po

Outline version	References			European projection	Issue date
	IEC	JEDEC	JEITA		
SOT1160-1	---	---	---		09-12-28 09-12-29

Figure 11. Package outline SOT1160-1 (XQFN10)

## 14 Abbreviations

Table 17. Abbreviations

Acronym	Description
CDM	Charged Device Model
DUT	Device Under Test
ESD	ElectroStatic Discharge
HBM	Human Body Model

## 15 Revision history

Table 18. Revision history

Document ID	Release date	Data sheet status	Change notice	Supersedes
74AVC2T245 v.2	20170406	Product data sheet	-	74AVC2T245 v.1
Modifications:	<ul style="list-style-type: none"> <li>The format of this data sheet has been redesigned to comply with the identity guidelines of Nexperia.</li> <li>Legal texts have been adapted to the new company name where appropriate.</li> </ul>			
74AVC2T245 v.1	20161219	Product data sheet	-	-

## 16 Legal information

### 16.1 Data sheet status

Document status <sup>[1][2]</sup>	Product status <sup>[3]</sup>	Definition
Objective [short] data sheet	Development	This document contains data from the objective specification for product development.
Preliminary [short] data sheet	Qualification	This document contains data from the preliminary specification.
Product [short] data sheet	Production	This document contains the product specification.

- [1] Please consult the most recently issued document before initiating or completing a design.
- [2] The term 'short data sheet' is explained in section "Definitions".
- [3] The product status of device(s) described in this document may have changed since this document was published and may differ in case of multiple devices. The latest product status information is available on the Internet at URL <http://www.nexperia.com>.

### 16.2 Definitions

**Draft** — The document is a draft version only. The content is still under internal review and subject to formal approval, which may result in modifications or additions. Nexperia does not give any representations or warranties as to the accuracy or completeness of information included herein and shall have no liability for the consequences of use of such information.

**Short data sheet** — A short data sheet is an extract from a full data sheet with the same product type number(s) and title. A short data sheet is intended for quick reference only and should not be relied upon to contain detailed and full information. For detailed and full information see the relevant full data sheet, which is available on request via the local Nexperia sales office. In case of any inconsistency or conflict with the short data sheet, the full data sheet shall prevail.

**Product specification** — The information and data provided in a Product data sheet shall define the specification of the product as agreed between Nexperia and its customer, unless Nexperia and customer have explicitly agreed otherwise in writing. In no event however, shall an agreement be valid in which the Nexperia product is deemed to offer functions and qualities beyond those described in the Product data sheet.

### 16.3 Disclaimers

**Limited warranty and liability** — Information in this document is believed to be accurate and reliable. However, Nexperia does not give any representations or warranties, expressed or implied, as to the accuracy or completeness of such information and shall have no liability for the consequences of use of such information. Nexperia takes no responsibility for the content in this document if provided by an information source outside of Nexperia. In no event shall Nexperia be liable for any indirect, incidental, punitive, special or consequential damages (including - without limitation - lost profits, lost savings, business interruption, costs related to the removal or replacement of any products or rework charges) whether or not such damages are based on tort (including negligence), warranty, breach of contract or any other legal theory. Notwithstanding any damages that customer might incur for any reason whatsoever, Nexperia's aggregate and cumulative liability towards customer for the products described herein shall be limited in accordance with the Terms and conditions of commercial sale of Nexperia.

**Right to make changes** — Nexperia reserves the right to make changes to information published in this document, including without limitation specifications and product descriptions, at any time and without notice. This document supersedes and replaces all information supplied prior to the publication hereof.

**Suitability for use** — Nexperia products are not designed, authorized or warranted to be suitable for use in life support, life-critical or safety-critical

systems or equipment, nor in applications where failure or malfunction of an Nexperia product can reasonably be expected to result in personal injury, death or severe property or environmental damage. Nexperia and its suppliers accept no liability for inclusion and/or use of Nexperia products in such equipment or applications and therefore such inclusion and/or use is at the customer's own risk.

**Applications** — Applications that are described herein for any of these products are for illustrative purposes only. Nexperia makes no representation or warranty that such applications will be suitable for the specified use without further testing or modification. Customers are responsible for the design and operation of their applications and products using Nexperia products, and Nexperia accepts no liability for any assistance with applications or customer product design. It is customer's sole responsibility to determine whether the Nexperia product is suitable and fit for the customer's applications and products planned, as well as for the planned application and use of customer's third party customer(s). Customers should provide appropriate design and operating safeguards to minimize the risks associated with their applications and products. Nexperia does not accept any liability related to any default, damage, costs or problem which is based on any weakness or default in the customer's applications or products, or the application or use by customer's third party customer(s). Customer is responsible for doing all necessary testing for the customer's applications and products using Nexperia products in order to avoid a default of the applications and the products or of the application or use by customer's third party customer(s). Nexperia does not accept any liability in this respect.

**Limiting values** — Stress above one or more limiting values (as defined in the Absolute Maximum Ratings System of IEC 60134) will cause permanent damage to the device. Limiting values are stress ratings only and (proper) operation of the device at these or any other conditions above those given in the Recommended operating conditions section (if present) or the Characteristics sections of this document is not warranted. Constant or repeated exposure to limiting values will permanently and irreversibly affect the quality and reliability of the device.

**Terms and conditions of commercial sale** — Nexperia products are sold subject to the general terms and conditions of commercial sale, as published at <http://www.nexperia.com/profile/terms>, unless otherwise agreed in a valid written individual agreement. In case an individual agreement is concluded only the terms and conditions of the respective agreement shall apply. Nexperia hereby expressly objects to applying the customer's general terms and conditions with regard to the purchase of Nexperia products by customer.

**No offer to sell or license** — Nothing in this document may be interpreted or construed as an offer to sell products that is open for acceptance or the grant, conveyance or implication of any license under any copyrights, patents or other industrial or intellectual property rights.

**Export control** — This document as well as the item(s) described herein may be subject to export control regulations. Export might require a prior authorization from competent authorities.

---

**2-bit dual supply translating transceiver with configurable voltage translation; 3-state**

**Non-automotive qualified products** — Unless this data sheet expressly states that this specific Nexperia product is automotive qualified, the product is not suitable for automotive use. It is neither qualified nor tested in accordance with automotive testing or application requirements. Nexperia accepts no liability for inclusion and/or use of non-automotive qualified products in automotive equipment or applications. In the event that customer uses the product for design-in and use in automotive applications to automotive specifications and standards, customer (a) shall use the product without Nexperia's warranty of the product for such automotive applications, use and specifications, and (b) whenever customer uses the product for automotive applications beyond Nexperia's specifications such use shall be solely at customer's own risk, and (c) customer fully indemnifies Nexperia for any liability, damages or failed product claims resulting from customer

design and use of the product for automotive applications beyond Nexperia's standard warranty and Nexperia's product specifications.

**Translations** — A non-English (translated) version of a document is for reference only. The English version shall prevail in case of any discrepancy between the translated and English versions.

## 16.4 Trademarks

Notice: All referenced brands, product names, service names and trademarks are the property of their respective owners.

## Contents

---

<b>1</b>	<b>General description .....</b>	<b>1</b>
<b>2</b>	<b>Features and benefits .....</b>	<b>1</b>
<b>3</b>	<b>Ordering information .....</b>	<b>2</b>
<b>4</b>	<b>Marking .....</b>	<b>2</b>
<b>5</b>	<b>Functional diagram .....</b>	<b>2</b>
<b>6</b>	<b>Pinning information .....</b>	<b>3</b>
6.1	Pinning .....	3
6.2	Pin description .....	3
<b>7</b>	<b>Functional description .....</b>	<b>4</b>
<b>8</b>	<b>Limiting values .....</b>	<b>4</b>
<b>9</b>	<b>Recommended operating conditions .....</b>	<b>5</b>
<b>10</b>	<b>Static characteristics .....</b>	<b>5</b>
<b>11</b>	<b>Dynamic characteristics .....</b>	<b>9</b>
11.1	Waveforms and test circuit .....	12
<b>12</b>	<b>Typical propagation delay characteristics .....</b>	<b>15</b>
<b>13</b>	<b>Package outline .....</b>	<b>19</b>
<b>14</b>	<b>Abbreviations .....</b>	<b>20</b>
<b>15</b>	<b>Revision history .....</b>	<b>20</b>
<b>16</b>	<b>Legal information .....</b>	<b>21</b>

---

Please be aware that important notices concerning this document and the product(s) described herein, have been included in section 'Legal information'.

---

© Nexperia B.V. 2017.

All rights reserved.

For more information, please visit: <http://www.nexperia.com>

For sales office addresses, please send an email to: [salesaddresses@nexperia.com](mailto:salesaddresses@nexperia.com)

Date of release: 6 April 2017  
Document identifier: 74AVC2T245