

- Designed for SDARS IF Receiver
- Low Insertion Loss
- 5.0 X 7.0 mm Surface-Mount Case
- Differential or Single Ended Input and Output
- Complies with Directive 2002/95/EC (RoHS)
- Moisture Sensitivity Level: 1
- AEC-Q200 Qualified

RoHS
Compliant

SF2037B-2

76.500 MHz
SAW Filter

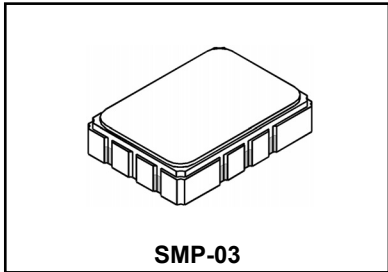

Absolute Maximum Ratings

Rating	Value	Units
Maximum Incident Power in Passband	+10	dBm
Max. DC voltage between any 2 terminals	30	VDC
Storage Temperature Range (with tape & reel)	-40 to +85	°C
Storage Temperature Range (without tape & reel)	-50 to +125	°C
Max Soldering Profile	265°C for 10 s	

Electrical Characteristics

Characteristic	Sym	Notes	Min	Typ	Max	Units			
Nominal Center Frequency	f_c			76.500		MHz			
Passband	Insertion Loss	IL		10.0	12.5	dB			
			1dB Passband	BW ₁	3.8		4.1	MHz	
			15dB Bandwidth	BW ₁₅			6.7	6.8	MHz
			30dB Bandwidth	BW ₃₀			7.7	7.8	MHz
Amplitude Ripple over $f_c \pm 1.9$ MHz				0.5	1.10	dB _{p-p}			
Group Delay Variation over $f_c \pm 1.9$ MHz		GDV		65	150	ns _{p-p}			
Rejection			50 to 70.44 MHz	37	43	dB			
			70.44 to 72.04 MHz	34	43				
			81.26 to 82.56 MHz	38	49				
			82.56 to 86.50 MHz	39	48				
			86.5 to 91.50 MHz	41	48				
			91.50 to 100.000 MHz	45	58				
Operating Temperature Range	T _A		-40		+105	°C			
Frequency Temperature Coefficient	FTC			-18		ppm/°C			
Differential Input			175 ohms						
Differential Output			1000 ohms						
Case Style			SMP-03 7 x 5 mm Nominal Footprint						
Lid Symbolization (YY=year, WW=week, S=shift, ## = Sequence Code)			RFM SF2037B-2 YYWWS##						

Electrical Connections

Connection	Terminals
Port 1 Hot	10
Port 1 Ground Return	1
Port 2 Hot	5
Port 2 Ground Return	6
Case Ground	All Others



CAUTION: Electrostatic Sensitive Device. Observe precautions for handling.

NOTES:

1. The design, manufacturing process, and specifications of this device are subject to change.
2. US or International patents may apply.
3. RoHS compliant from the first date of manufacture.

Matching Circuit and Matching Component Values Used in G3 Sirius Radios

(Refer to Sirius Radio G3 Chipset Application Note, Doc. #RX000104-B, Sec. 4.2.4)

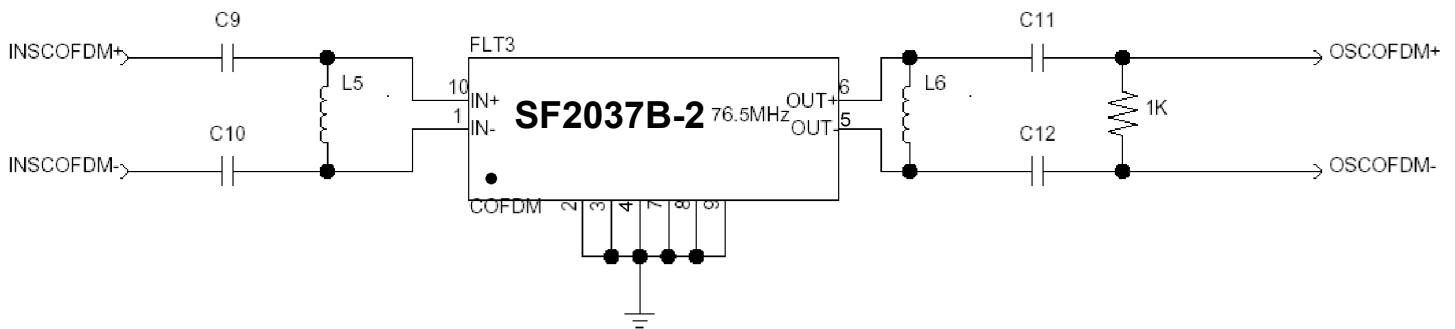

COFDM Narrowband SAW Matching Circuit

COFDM Narrowband SAW Matching Values

Reference Designator	Value
C9	10 pF
C10	10 pF
L5	270 nH
L6	390 nH
C11	100 pF
C12	100 pF

Matching Circuit and Matching Component Values Used on Filter Demo Board

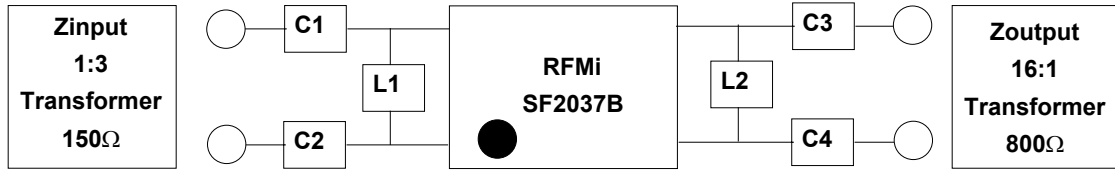

SF2037B
76.500 MHz

C1 = 9pF
C2 = 9pF
L1 = 270nH
L2 = 330nH
C3 = 18pF
C4 = 18pF

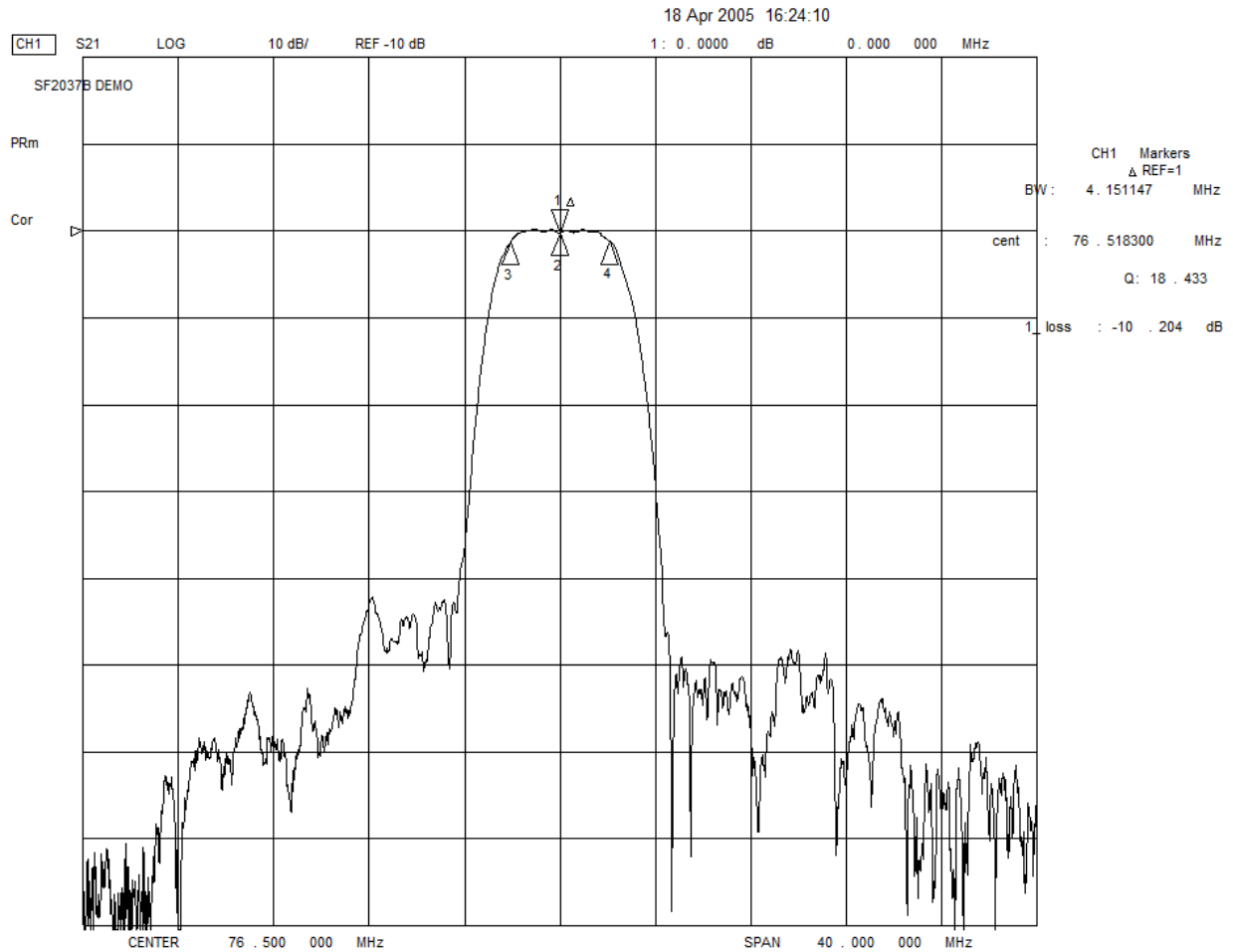

18 Apr 2005 16:18:31

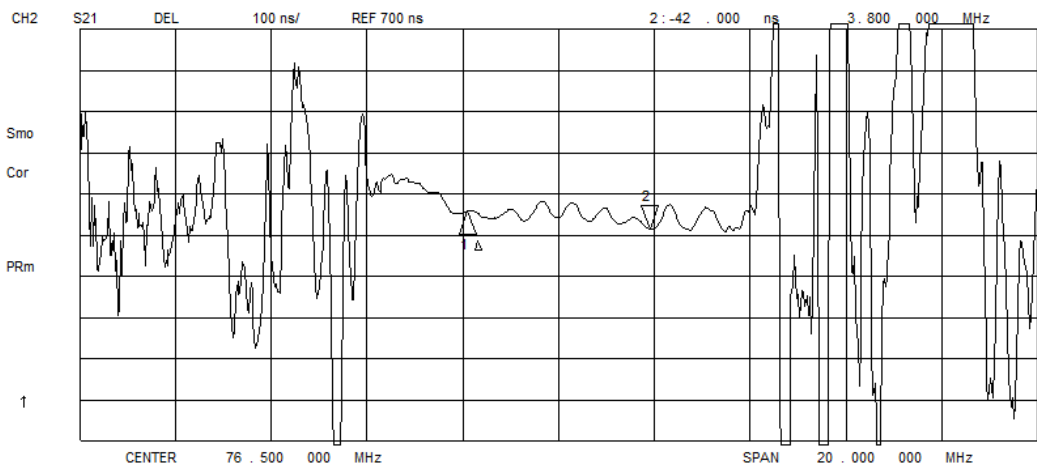
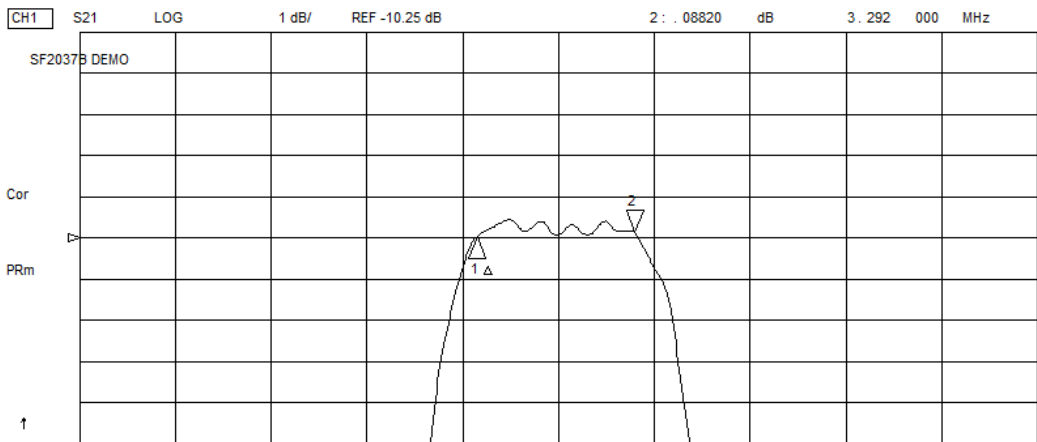

18 Apr 2005 16:28:43

CH1 S11 1 UFS

1: 59.928 \angle -9.8086 \angle 212.11 pF 76.500 000 MHz

SF2037B DEMO

Cor

PRm

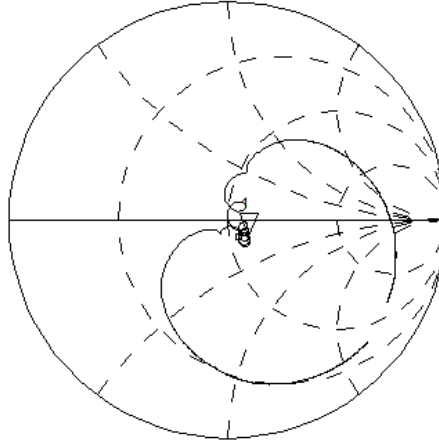

CH2 S22 1 UFS

1: 43.949 \angle 3.1992 \angle 6.6558 nH 76.500 000 MHz

Cor

PRm

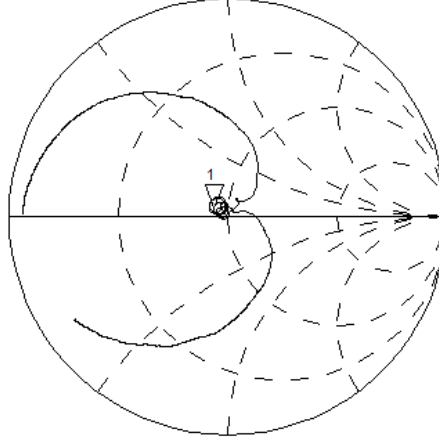

CENTER 76.500 000 MHz

SPAN 40.000 000 MHz

SMP-03 Case

10-Terminal Ceramic Surface-Mount Case

7 x 5 mm Nominal Footprint

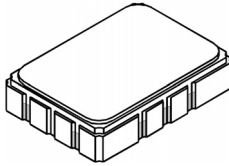

Recommended PCB Footprint

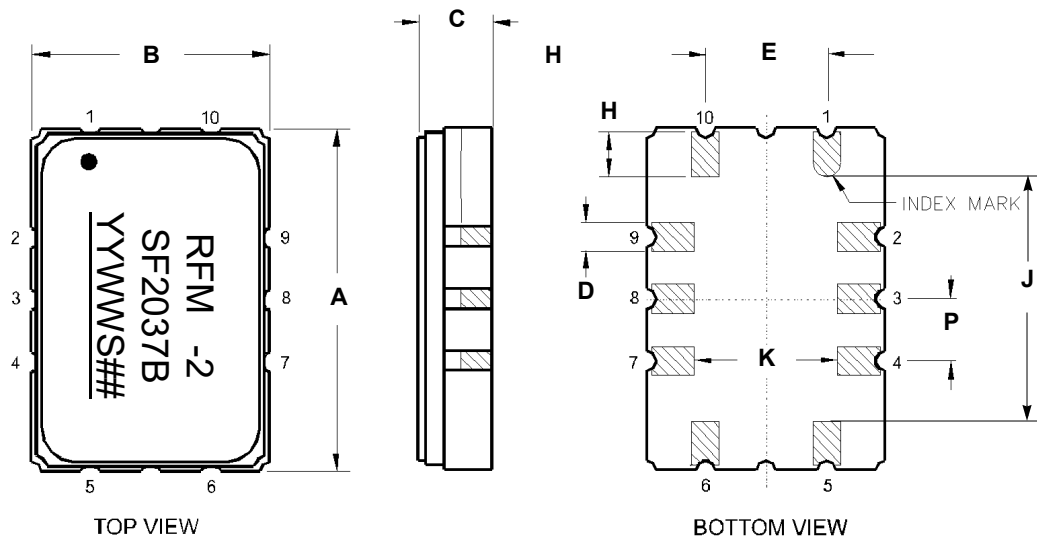
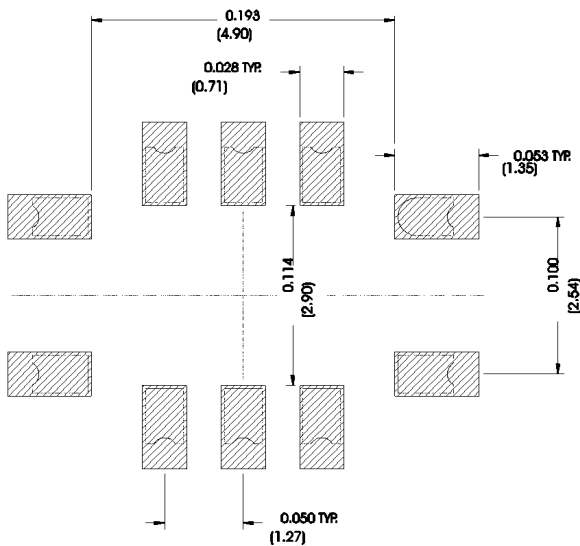

Case Dimensions

Dimension	mm			Inches		
	Min	Nom	Max	Min	Nom	Max
A	6.80	7.00	7.20	0.268	0.276	0.283
B	4.80	5.00	5.20	0.189	0.197	0.205
C		1.65	2.00		0.065	0.079
D	.47	0.60	.73	0.019	0.024	0.029
E	2.41	2.54	2.67	0.095	0.100	0.105
H	0.87	1.0	1.13	0.034	0.039	0.044
J	4.87	5.00	5.13	0.192	0.197	0.202
K	2.87	3.00	3.13	0.113	0.118	0.123
P	1.14	1.27	1.40	0.045	0.050	0.055

Materials

Solder Pad Termination	Au plating 30 - 60 ulnches (76.2-152 uM) over 80-200 ulnches (203-508 uM) Ni.
Lid	Fe-Ni-Co Alloy Electroless Nickel Plate (8-11% Phosphorus) 100-200 ulnches Thick
Body	Al ₂ O ₃ Ceramic

Electrical Connections

Connection		Terminals
Port 1	Input or Return	10
	Return or Input	1
Port 2	Output or Return	5
	Return or Output	6
Ground		All others
Single Ended Operation		Return is ground
Differential Operation		Return is hot

Tape and Reel Specifications

Tape and Reel Standard per ANSI/EIA-481

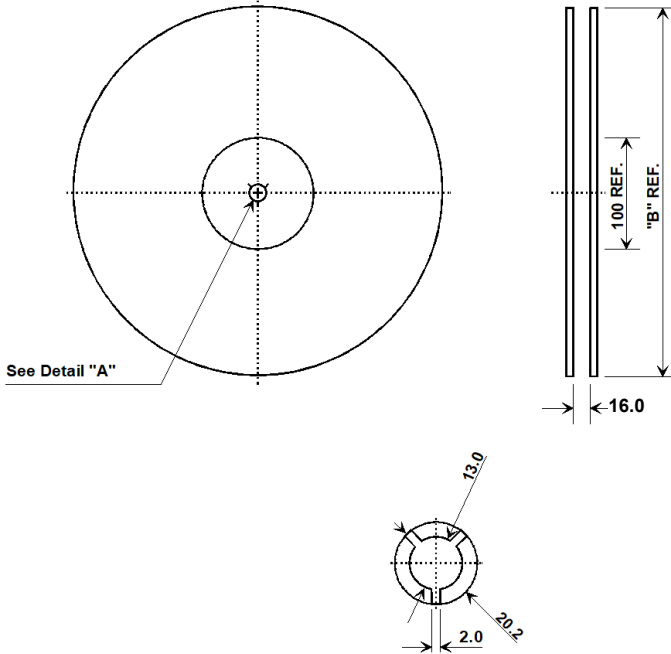

"B" Nominal Size		Quantity Per Reel
Inches	millimeters	
7	178	500
13	330	2000

Product Reflow/ESD

Reflow Peak Temperature	265	°C
Reflow Peak Time	10	Seconds
Liquidus 217 Temperature/Time	110	Seconds
Over Liquidus 230 Temperature/Time	70	Seconds
Reflow Condition	SMT	
Class Level HBM	2	
HBM(V)	2000	HBM(V)
MM(V)	N/A	MM(V)
CDM(V)	2000	CDM(V)

COMPONENT ORIENTATION and DIMENSIONS

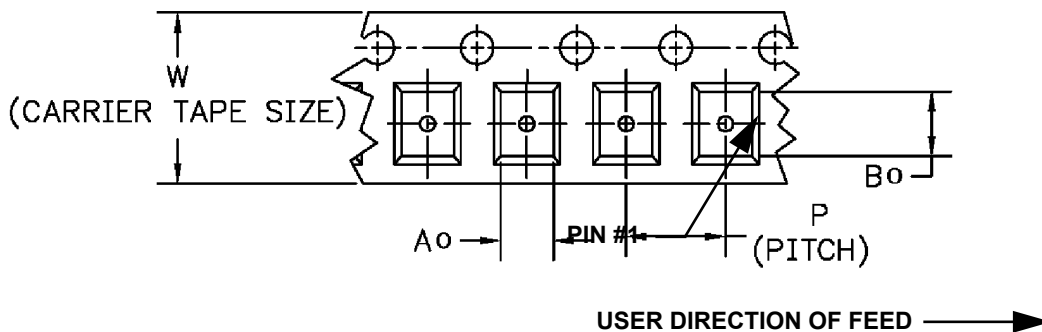
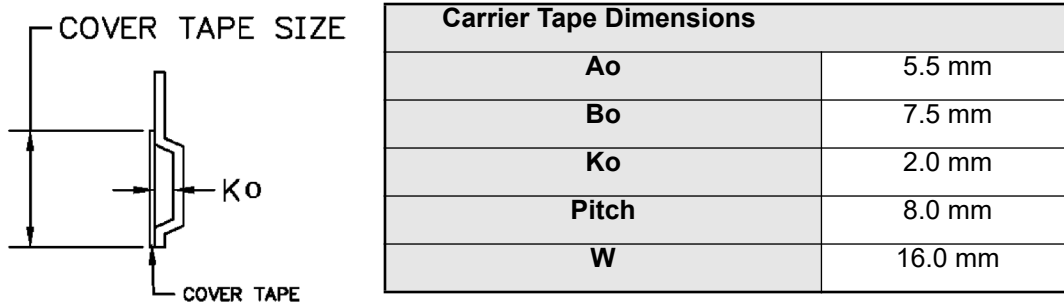

Recommended Reflow Profile

1. Preheating shall be fixed at 150~180°C for 60~90 seconds.
2. Ascending time to preheating temperature 150°C shall be 30 seconds min.
3. Heating shall be fixed at 220°C for 50~80 seconds and at 260°C+0/-5°C peak (10 seconds).
4. Time: 5 times maximum.

