



OH300-71003SV-100.0M OCVCXO

CONNOR WINFIELD



2111 Comprehensive Drive

Aurora, Illinois 60505

Phone: 630-851-4722

Fax: 630-851-5040

www.conwin.com

US Headquarters:

630-851-4722

European Headquarters:

+353-61-472221

Description:

Connor-Winfield's model OH300-71003SV is a 3.3 Vdc, Sinewave output, Oven Compensated Voltage Controlled Crystal Oscillator (OCVCXO) in a 22 x 25.4mm surface mount package. The OH300-71003SV is designed for applications requiring very high frequency stability and low phase noise.



Features:

- Output Frequency: 100.0 MHz
- 3.3 Vdc Operation
- 22 x 25.4 mm SMT Package
- Frequency Stability: ± 10 ppb
- Temperature Range: -20 to 70°C
- Sinewave Output
- Low Jitter / Low Phase Noise
- RoHS Compliant / Lead Free

Absolute Maximum Ratings

Parameter	Minimum	Nominal	Maximum	Units	Notes
Storage Temperature	-55	-	125	°C	
Supply Voltage (Vcc)	-0.5	-	4.5	Vdc	
Control Voltage (Vc)	-1.0	-	7.0	Vdc	
Operating Supply Voltage	3.13	3.30	3.47	Vdc	

Absolute Ratings: Stresses beyond those listed under "absolute maximum ratings" may cause permanent damage to the device. These are stress ratings only. The functional operation of the device at those or any other conditions beyond those indicated under "recommended operating conditions" is not implied. Exposure to conditions outside the "recommended operating conditions" for any extended period of time may adversely impact device reliability and result in failures not covered by warranty.

Operating Specifications

Parameter	Minimum	Nominal	Maximum	Units	Notes
Center Frequency (Fo)	-	100.0	-	MHz	
Operating Temperature	-20	-	70	°C	
Frequency Calibration @ 25°C	-0.1	-	0.1	ppm	
Frequency Stability vs. Temperature	-10	-	10	ppb	1
Frequency vs. Supply Voltage	-5.0	-	5.0	ppb	Vcc $\pm 5\%$
Frequency vs. Load	-2.0	-	2.0	ppb	Load $\pm 5\%$
Aging: Daily	-5.0	-	5.0	ppb/day	2
Aging: First Year	-300	-	300	ppb	
Lifetime Tolerance: (20 years)	-800	-	800	ppb	3
Supply Voltage (Vcc)	3.13	3.30	3.47	Vdc	4
Power Consumption: Vcc = 3.30 Vdc					
Steady State, @ 25°C	-	-	1.25	W	5
Turn On @ -20°C	-	-	2.75	W	5
Integrated Phase Jitter (BW: 12kHz to 20MHz)	-	-	0.5	ps rms	
Short Term Allan Deviation: (1s)	-	5.0E-11	-		
Start-Up Time:	-	-	500	ms	
Warm Up Time: @ 25°C	-	-	5	minutes	6

Phase Noise

Parameter	Minimum	Nominal	Maximum	Units	Notes
SSB Phase Noise at 1Hz offset	-	-65	-	dBc/Hz	
SSB Phase Noise at 10Hz offset	-	-90	-	dBc/Hz	
SSB Phase Noise at 100Hz offset	-	-120	-	dBc/Hz	
SSB Phase Noise at 1KHz offset	-	-127	-	dBc/Hz	
SSB Phase Noise at 10KHz offset	-	-145	-	dBc/Hz	
SSB Phase Noise at 100KHz offset	-	-150	-	dBc/Hz	

Input Characteristics

Parameter	Minimum	Nominal	Maximum	Units	Notes
Control Voltage Range	0.3	1.65	3.0	V	7
Pull Range	± 0.6	-	-	ppm	
Input Impedance	100K	-	-	Ohm	

Ordering Information

OH300-71003SV-100.0M



Bulletin	Cx282
Page	1 of 4
Revision	01
Date	07 Sept 2017



Attention: System Designers please review Application Note AN2093:
System Design Information: Printed Circuit Board Layout Guidelines for OCXO Oscillators.
www.conwin.com/support.html



Sinewave Output Characteristics

Parameter	Minimum	Nominal	Maximum	Units	Notes
Output Load	-	50	-	Ohm	
Output Power:	+5	-	-	dBm	
Harmonics;	-	-	-30	dBc	
Spurious Output	-	-	-80	dBc	

Notes:

1. Referenced to the frequency measured @ 25°C, Control voltage (Vc) = 1.65Vdc.
2. At time of shipment after 48 hours of operation.
3. Inclusive of Calibration, Operating Temperature, Supply Voltage change, Load change, and 20 Year Aging.
4. Supply voltage must reach Vcc levels monotonically within a ramp-up time of <12 ms.
5. Measured with Vcc = Nominal in calm air.
6. Measured @ 25°C, within ±100 ppb, referenced one hour after turn-on.
7. To ensure proper operation of this VCOCXO, the control voltage must be biased at the nominal value, 1.65Vdc. Failure to bias the Vc input will result in unstable operation

Re-Stabilization Time

Off Time	Re stabilization Time
<1 Hour	<2 Hours *
<6 Hour	<12 Hours *
<24 Hour	<48 Hours *
1 to 16 Days	48 Hours + 1/4 Off Time *
>16 Days	<6 Days *

* For a given off time, the time required to meet daily aging, short term stability requirements.

Package Characteristics

OH300 Package	Package consisting of a FR-4 substrate and Ryton-R-4 cover. Water Resistant package, non-hermetic seal. (Engineering Properties of Ryton R-4 Application Note AN2100)
---------------	---

Environmental Characteristics

Shock	500 G's 1ms, Halfsine, 3 shocks per direction, per MIL-STD 202G, Method 213B Test Condition D.
Sinusoidal Vibration	0.06" D.A. or 10G's Peak, 10 to 500 Hz, per MIL-STD-202G, Method 204D, Test Condition A.
Random Vibration	5.35 G's rms. 20 to 2000 Hz per MIL-STD-202G, Method 214, Test Condition 1A, 15 minutes each axis.
Moisture	10 cycles, 95% RH, Per MIL-STD-202G, Method 112.
Marking Permanency	Per MIL-STD-202G, Method 215J.

Solder Process Recommendations: RoHS compliant, lead free. See solder profile on page 4.	
In-line reflow:	Refer to recommended reflow pre-heat and reflow temperatures on page 4. Package material consists of metal cover with FR4 substrate. Component solder is Pb-free high temperature eutectic alloy with melting point of 221 deg C.
In-line oven profile:	We recommend using KIC profiler or similar device placing one of the thermocouples on the device to insure that the internal package temperature does not exceed 221°C.
Removal of device:	If for any reason the device needs to be removed from the board, use a temperature controlled repair station with profile monitoring capabilities. Following a monitored profile will insure the device is properly pre-heated prior to reflow. Refer to IPC 610E for inspection guidelines.

Recommended Cleaning Process: (If required)	Device is non-hermetic, water resistance with four weep holes, one in each corner to allow moisture to be removed during the drying cycle. We recommend in-line warm water wash with air knife and drying capabilities. If cleaner does not have drying capability, then use hot air circulated oven. Boards should be placed in the oven vertically for good water runoff
---	--

Device must be dried properly prior to use!

Note: If saponifier is used make sure the device is rinsed properly to insure all residues are removed. PH of saponifier should not exceed 10.

Drying Temperature:	Between 85 to 100°C.
Drying Time:	Time will vary depending on the board size.

Caution: Do not submerge the device!



*Attention: System Designers please review Application Note AN2093:
System Design Information: Printed Circuit Board Layout Guidelines for OCXO Oscillators.
www.conwin.com/support.html*

Bulletin	Cx282
Page	2 of 4
Revision	01
Date	07 Sept 2017



Package Outline

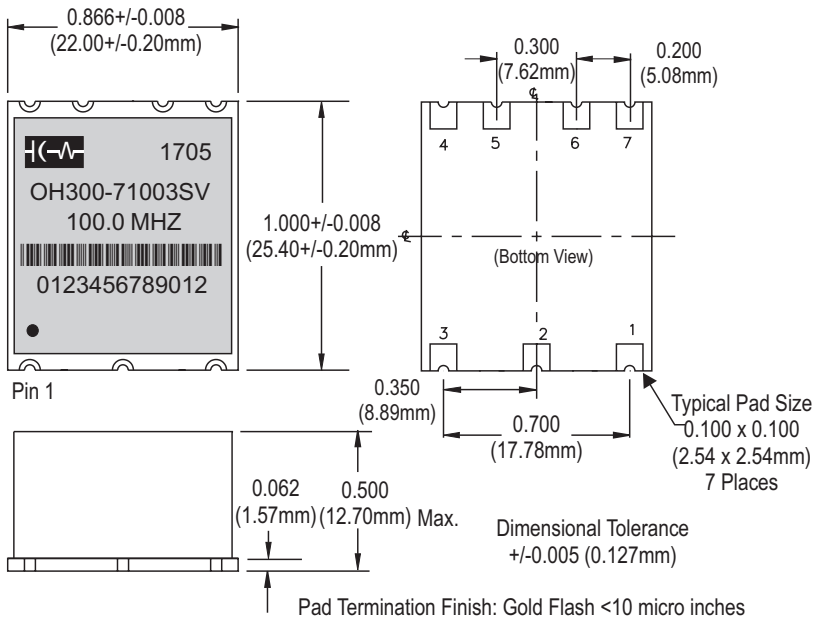

Suggested Pad Layout

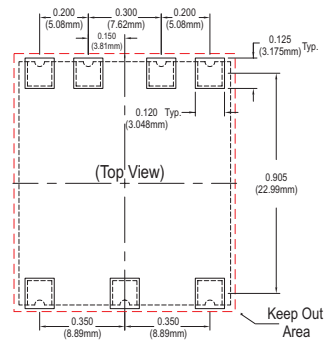

* Do not route any traces in the keep out area. It is recommended the next layer under the keep out area is to be ground plane.

Marking Information

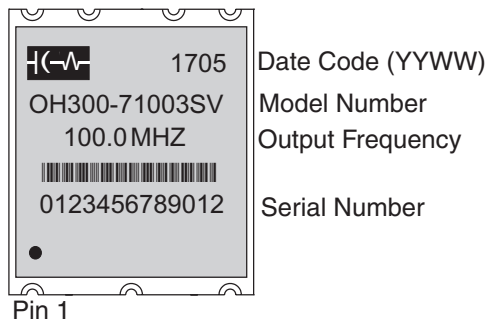

Pad Connections

Pad	Connection
1:	Control Voltage (Vc)
2:	Do not Connect
3:	Supply Voltage (Vcc)
4:	RF Output
5:	Do Not Connect
6:	Do Not Connect
7:	Ground

DO NOT connect "DNC" pads to ground or supply rails.

Test Circuit

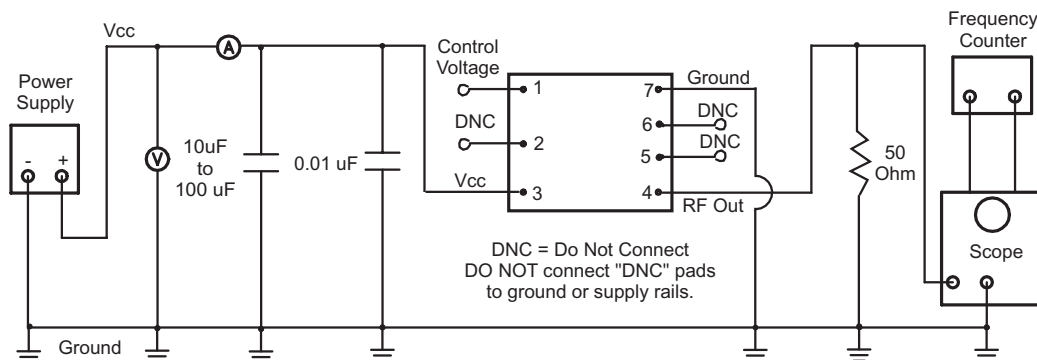

Attention: System Designers please review Application Note AN2093:
System Design Information: Printed Circuit Board Layout Guidelines for OCXO Oscillators.
www.conwin.com/support.html

Bulletin	Cx282
Page	3 of 4
Revision	01
Date	07 Sept 2017

Output Waveform

Sinewave Output, +5 dBm minimum into 50 Ohms

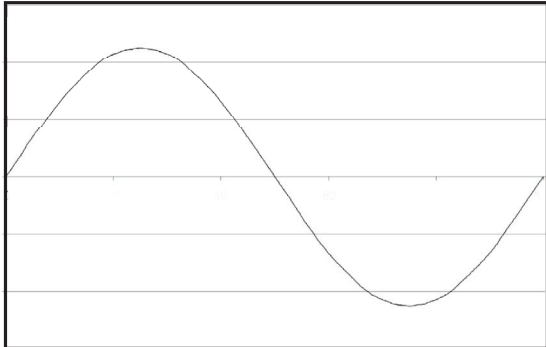

Solder Profile

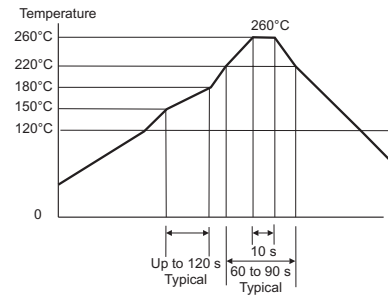

Meets IPC/JEDEC J-STD-020C

Tape and Reel Information

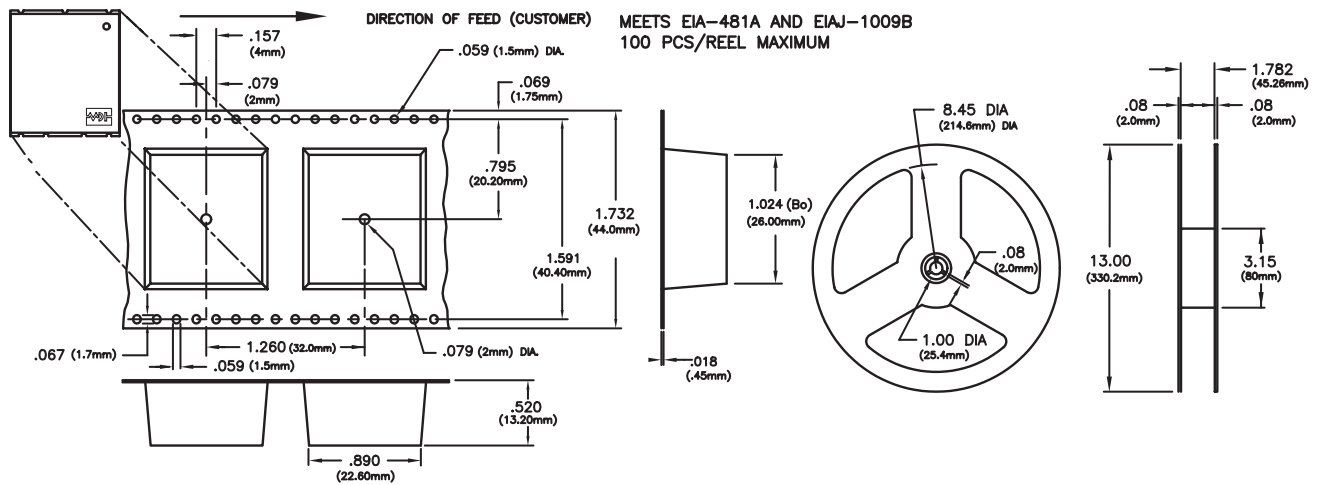

Revision History

Revision	Date	Changes
00	02/14/17	Initial Release
01	09/07/17	Update phase noise specification



Attention: System Designers please review Application Note AN2093:
System Design Information: Printed Circuit Board Layout Guidelines for OCXO Oscillators.
www.conwin.com/support.html

Bulletin	Cx282
Page	4 of 4
Revision	01
Date	07 Sept 2017